



**BAHCO**



Catalogue  
**2024**





# Catalogue 2024

## Catalogue

---

|                             |                |
|-----------------------------|----------------|
| <b>Contents</b>             | <b>2-9</b>     |
| <b>Alphanumerical index</b> | <b>665-745</b> |
| <b>Warranty</b>             | <b>751</b>     |

---

12 BANDSAWS & POWER SAWS

21-36 FILES



37-60 WRENCHES



61-102 SOCKETS & RATCHETS



103-122 TORQUE TOOLS



123-186 POWER TOOL ACCESSORIES



**BAHCO**

187-220 SCREWDRIVERS



221-230 L-KEYS



231-264 PLIERS



265-272 PIPE WRENCHES & TUBING TOOLS



273-288 AIR TOOLS



289-294 CORDLESS POWER TOOLS



295-356 AUTOMOTIVE TOOLS



357-358 LIGHTING EQUIPMENT



359-362 INSPECTION TOOLS



363-372 EXTRACTORS & PULLERS



373-470 TOOL STORAGE & TOOLKITS



**BAHCO**



471-490 TOOLS @ HEIGHT



491-504 INSULATED TOOLS



505-524 NON SPARKING TOOLS



525-530 STAINLESS STEEL TOOLS



531-536 TWEEZERS & ELECTRONICS SPECIALTY TOOLS



537-546 MEASURING & LAYOUT



547-554 WALL TOOLS



555-558 HAND HACKSAWS



559-568 HANDSAWS



569-574 WOOD CHISELS



575-586 SCISSORS & KNIVES



587-590 CLAMPS & VICES



591-598 HAMMERS



599-602 TREE FELLING & FORESTRY TOOLS



603-610 COLD CHISELS & PUNCHES



611-614 PRY BARS



615-618 PLANTING & CULTIVATING TOOLS



619-638 PRUNING TOOLS



639-642 AIR TOOLS OUTDOOR



643-666 LINDSTRÖM





# Contents

|                                  |                |  |                |
|----------------------------------|----------------|--|----------------|
| <b>Bandsaws &amp; Power Saws</b> | <b>11-20</b>   | <b>Screwdrivers</b>                                    | <b>187-220</b> |
| METAL CUTTING BI-METAL BANDSAWS  | 12             | ERGO™ SCREWDRIVERS WITH RIGGED RUBBER GRIP & COLOUR ID | 188            |
| METAL CUTTING TRI-METAL BANDSAWS | 15             | ERGO™ SCREWDRIVERS WITH IMPACT GRIP                    | 198            |
| METAL CUTTING CARBIDE BANDSAWS   | 15             | BAHCOFIT SCREWDRIVERS WITH GROOVED RUBBER GRIP         | 200            |
| WOOD CUTTING BANDSAW             | 17             | SCREWDRIVERS WITH RUBBERED GRIP                        | 208            |
| INSULATION CUTTING BANDSAWS      | 17             | SCREWDRIVERS WITH RATCHETING GRIP                      | 211            |
| HSS CIRCULAR SAWBLADES           | 17             | SCREWDRIVERS WITH PRECISION GRIP                       | 212            |
| POWER HACKSAW BLADES             | 18             | SCREWDRIVERS WITH T-HANDLE GRIP                        | 215            |
| BANDSAW ACCESSORIES              | 20             | SCREWDRIVERS WITH 1/4" BIT HOLDERS                     | 216            |
|                                  |                | SCREWDRIVERS WITH WOODEN OR PLASTIC GRIP               | 217            |
| <b>Files</b>                     | <b>21-36</b>   | ELECTRICAL TESTERS                                     | 219            |
| ENGINEERING FILES                | 22             | ACCESSORIES  | 219            |
| SHARPENING FILES                 | 26             |  |                |
| RASPS                            | 30             | <b>L-Keys</b>  | <b>221-230</b> |
| MILLED TOOTH FILES               | 31             | HEXAGONAL TIPPED                                       | 222            |
| NEEDLE FILES                     | 31             | TORX® TIPPED   | 226            |
| DIAMOND FILES                    | 34             | DOUBLE OFFSET  | 229            |
| ACCESSORIES                      | 35             | MULTITOOLS   | 229            |
| <b>Wrenches</b>                  | <b>37-60</b>   |  |                |
| ADJUSTABLE WRENCHES              | 38             | <b>Pliers</b>  | <b>231-264</b> |
| COMBINATION WRENCHES             | 40             | CUTTING PLIERS   | 232            |
| RATCHETING WRENCHES              | 45             | COMBINATION PLIERS                                     | 239            |
| OPEN END WRENCHES                | 48             | GRIPPING PLIERS  | 241            |
| RING END WRENCHES                | 52             | WATERPUMP PLIERS                                       | 247            |
| FLARE NUT WRENCHES               | 54             | CIRCLIP PLIERS   | 249            |
| SLOGGING WRENCHES                | 55             | WIRE STRIPPERS & DISMANTLING TOOLS                     | 251            |
| SOCKET WRENCHES                  | 56             | CRIMPING PLIERS  | 254            |
| MULTIFITTING KEYS                | 59             | PLIERS SETS  | 257            |
| HOOK WRENCHES                    | 60             | LOCKING PLIERS   | 259            |
|                                  |                | RIVETING TOOLS   | 263            |
| <b>Sockets &amp; Ratchets</b>    | <b>61-102</b>  | SPECIAL PLIERS   | 264            |
| SOCKET SETS                      | 62             |  |                |
| 1/4"                             | 78             | <b>Pipe Wrenches &amp; Tubing Tools</b>                | <b>265-272</b> |
| 3/8"                             | 85             | PIPE WRENCHES  | 266            |
| 1/2"                             | 91             | TUBE CUTTING TOOLS                                     | 268            |
| 3/4"                             | 98             | BENDING & FORMING TOOLS                                | 270            |
| 1"                               | 101            | DEBURRING TOOLS  | 271            |
| EMPTY SOCKET SET CASES           | 102            |  |                |
| SCAFFOLDING WRENCHES             | 102            | <b>Air Tools</b>                                       | <b>273-288</b> |
|                                  |                | IMPACT WRENCHES  | 274            |
| <b>Torque Tools</b>              | <b>103-122</b> | RATCHETS   | 277            |
| DIGITAL TORQUE WRENCHES          | 104            | GRINDERS, SANDERS & POLISHERS                          | 277            |
| MECHANICAL TORQUE WRENCHES       | 106            | DRILLS & SCREWDRIVERS                                  | 282            |
| TORQUE SCREWDRIVERS              | 111            | CUTTING TOOLS  | 283            |
| MULTIPLIERS                      | 113            | HAMMERS, RIVETERS & MARKERS                            | 284            |
| TORQUE TESTERS                   | 114            | PAINT GUNS   | 285            |
| TORQUE ANGLE ADAPTORS            | 115            | BLOWING & CLEANING TOOLS                               | 286            |
| INSERT TOOLS                     | 115            | AIR TOOLS ACCESSORIES & EQUIPMENT                      | 286            |
| EMPTY SET CASES FOR TORQUE TOOLS | 121            |  |                |
| <b>Power Tool Accessories</b>    | <b>123-186</b> | <b>Cordless Power Tools</b>                            | <b>289-294</b> |
| HOLESAWS                         | 124            | IMPACT WRENCHES  | 290            |
| SABRE SAWBLADES                  | 134            | RATCHETS   | 290            |
| JIGSAW BLADES                    | 138            | DRILLS & SCREWDRIVERS                                  | 291            |
| MULTI TOOL ACCESSORIES           | 139            | GRINDERS, SANDERS & POLISHERS                          | 292            |
| CIRCULAR SAW BLADES              | 141            | CUTTING TOOLS  | 292            |
| ABRASIVE CUTTING DISCS           | 142            | GREASERS   | 293            |
| BANDSAW BLADES                   | 143            | BATTERIES & CHARGERS                                   | 293            |
| CARBIDE ROTARY BURRS             | 144            |  |                |
| DRILL BITS                       | 148            |  |                |
| SCREWDRIVER BITS                 | 156            |  |                |
| IMPACT TOOLS                     | 172            |  |                |



|  |                |
|--|----------------|
| <b>Automotive Tools</b>                | <b>295-356</b> |
| ENGINE TOOLS                           | 296            |
| EXHAUST TOOLS                          | 318            |
| OIL SERVICE TOOLS & EQUIPMENT          | 319            |
| BRAKE SYSTEM TOOLS & EQUIPMENT         | 324            |
| TRANSMISSION & WHEEL TOOLS             | 328            |
| SUSPENSION TOOLS & EQUIPMENT           | 336            |
| BATTERY MANAGEMENT & ELECTRICAL TOOLS  | 337            |
| PRESSES & ACCESSORIES                  | 341            |
| GENERAL AUTOMOTIVE TOOLS AND EQUIPMENT | 342            |
| BODY SHOP TOOLS                        | 344            |
| LIFTING EQUIPMENT                      | 349            |

|                           |                |
|---------------------------|----------------|
| <b>Lighting Equipment</b> | <b>357-358</b> |
| HAND LIGHTS               | 358            |
| HEAD LIGHTS               | 358            |
| CABLE REELS               | 358            |

|                         |                |
|-------------------------|----------------|
| <b>Inspection Tools</b> | <b>359-362</b> |
| ENDOSCOPES              | 360            |
| STETHOSCOPES            | 360            |
| MIRRORS                 | 360            |
| MAGNIFIERS              | 361            |

|                                 |                |
|---------------------------------|----------------|
| <b>Extractors &amp; Pullers</b> | <b>363-372</b> |
| MECHANICAL                      | 364            |
| PRY BARS                        | 370            |
| PICKING TOOLS                   | 371            |
| THREAD TOOLS                    | 371            |

|                                    |                |
|------------------------------------|----------------|
| <b>Tool Storage &amp; Toolkits</b> | <b>373-470</b> |
| TOOL TROLLEYS                      | 374            |
| RIGID CASES                        | 436            |
| CABINETS, PANELS & WORKBENCHES     | 448            |
| METALLIC TOOL BOXES                | 456            |
| PLASTIC BOXES & CASES              | 462            |
| TEXTILE & LEATHER EQUIPMENT        | 463            |

|                             |                |
|-----------------------------|----------------|
| <b>Tools @ Height</b>       | <b>471-490</b> |
| TOOL STORAGE & LANYARDS     | 472            |
| WRENCHES                    | 475            |
| PIPE WRENCHES               | 477            |
| SOCKETS & RATCHETS          | 477            |
| SCREWDRIVERS                | 480            |
| PLIERS                      | 482            |
| CUTTING TOOLS               | 484            |
| HAMMERS, PRY BARS & CHISELS | 486            |
| MEASURING & LAYOUT          | 488            |
| TORQUE TOOLS                | 489            |
| CLAMPING TOOLS              | 489            |
| OTHER TOOLS                 | 489            |
| GLOVES                      | 490            |

|                              |                |
|------------------------------|----------------|
| <b>Insulated Tools</b>       | <b>491-504</b> |
| SCREWDRIVERS                 | 492            |
| PLIERS                       | 498            |
| WRENCHES                     | 501            |
| INSULATED SOCKETS & RATCHETS | 502            |
| SCISSORS & KNIVES            | 502            |
| TWEEZERS                     | 503            |
| PROTECTIVE EQUIPMENT         | 503            |
| TOOLSETS                     | 503            |

|                             |                |
|-----------------------------|----------------|
| <b>Non Sparking Tools</b>   | <b>505-524</b> |
| WRENCHES                    | 506            |
| PIPE WRENCHES & VALVE TOOLS | 511            |
| SOCKETS & RATCHETS          | 512            |
| SCREWDRIVERS                | 515            |
| PLIERS                      | 516            |
| HAMMERS, PRY BARS & CHISELS | 518            |
| SCRAPERS                    | 521            |
| DIGGING TOOLS               | 523            |
| EXTRACTORS & PULLERS        | 523            |
| TORQUE TOOLS                | 524            |

|                              |                |
|------------------------------|----------------|
| <b>Stainless Steel Tools</b> | <b>525-530</b> |
| WRENCHES                     | 526            |
| SOCKETS & RATCHETS           | 527            |
| SCREWDRIVERS                 | 528            |
| L-KEYS                       | 528            |
| SCREWDRIVER BITS             | 529            |
| PLIERS                       | 529            |
| HAMMERS                      | 530            |
| PUNCHES & COLD CHISELS       | 530            |

|   |                |
|---|----------------|
| <b>Tweezers &amp; Electronics Specialty Tools</b> | <b>531-536</b> |
| TWEEZERS  | 532            |
| SOLDERING TOOLS                                   | 535            |
| FINE MECHANICAL                                   | 535            |

|                               |                |
|-------------------------------|----------------|
| <b>Measuring &amp; Layout</b> | <b>537-546</b> |
| MEASURING TAPES               | 538            |
| MEASURING WHEELS              | 539            |
| SPIRIT LEVELS                 | 539            |
| MARKING                       | 542            |
| RULES                         | 543            |
| SQUARES                       | 544            |
| PRECISION MEASURING           | 545            |

|                   |                |
|-------------------|----------------|
| <b>Wall Tools</b> | <b>547-554</b> |
| SCRAPERS          | 548            |
| MASONRY TOOLS     | 550            |
| DRYWALL TOOLS     | 552            |

|                      |                |
|----------------------|----------------|
| <b>Hand Hacksaws</b> | <b>555-558</b> |
| HAND HACKSAW FRAMES  | 556            |
| HAND HACKSAW BLADES  | 557            |

|                                    |                |
|------------------------------------|----------------|
| <b>Handsaws</b>                    | <b>559-568</b> |
| HANDSAWS FOR CONSTRUCTION MATERIAL | 560            |
| HANDSAWS FOR WOOD                  | 561            |
| PRECISION HANDSAWS                 | 565            |
| HANDLES & SHARPENERS               | 566            |
| FRET SAWS & SAWBLADES              | 566            |
| COPING SAWS & SAWBLADES            | 567            |
| MUSICAL SAW                        | 567            |

|                         |                |
|-------------------------|----------------|
| <b>Wood Chisels</b>     | <b>569-574</b> |
| WOODWORKING CHISELS     | 570            |
| GOUGE CHISELS           | 572            |
| DEMOLITION CHISELS      | 572            |
| WOOD CHISEL ACCESSORIES | 573            |

|                              |                |
|------------------------------|----------------|
| <b>Scissors &amp; Knives</b> | <b>575-586</b> |
| METAL SHEARS                 | 576            |
| SCISSORS                     | 579            |
| KNIVES                       | 580            |

**Clamps & Vices** **587-590**

|                        |     |
|------------------------|-----|
| CLAMPS                 | 588 |
| BENCH VICES            | 589 |
| BENCH VICE ACCESSORIES | 590 |

**Hammers** **591-598**

|                             |     |
|-----------------------------|-----|
| CLAW HAMMERS                | 592 |
| NAIL PULLERS                | 593 |
| ENGINEERING HAMMERS         | 593 |
| CONSTRUCTION HAMMERS        | 594 |
| SPECIALTY HAMMERS           | 596 |
| SLUDGE HAMMERS              | 596 |
| SOFT FACE HAMMERS & MALLETS | 597 |

**Tree Felling & Forestry Tools** **599-602**

|                        |     |
|------------------------|-----|
| AXES, HATCHETS & MAULS | 600 |
| WEDGES                 | 601 |

**Cold Chisels & Punches** **603-610**

|                                      |     |
|--------------------------------------|-----|
| COLD CHISELS                         | 604 |
| COLD CHISELS WITH GUARD              | 605 |
| COLD CHISELS, REGRINDABLE            | 605 |
| COLD CHISELS ACCESSORIES             | 606 |
| PUNCHES                              | 606 |
| PUNCHES WITH 2-COMPONENT HANDLE      | 610 |
| COLD CHISELS WITH 2-COMPONENT HANDLE | 610 |

**Pry Bars** **611-614**

|               |     |
|---------------|-----|
| WRECKING BARS | 612 |
|---------------|-----|

**Planting & Cultivating Tools** **615-618**

|                    |     |
|--------------------|-----|
| SMALL GARDEN TOOLS | 616 |
|--------------------|-----|

**Pruning Tools** **619-638**

|                           |     |
|---------------------------|-----|
| SECATEURS                 | 620 |
| FRUIT PICKING TOOLS       | 624 |
| LOPPERS                   | 624 |
| POLE SAWS & TOP PRUNERS   | 626 |
| HEDGE SHEARS              | 630 |
| GRASS SHEARS              | 631 |
| PRUNING KNIVES            | 632 |
| SCISSORS                  | 632 |
| BOW SAWS                  | 633 |
| PRUNING SAWS              | 634 |
| SPARE PARTS & ACCESSORIES | 636 |
| ACCESSORIES & MAINTENANCE | 636 |

**Air Tools Outdoor** **639-642**

|           |     |
|-----------|-----|
| SECATEURS | 640 |
|-----------|-----|

**Lindström** **643-666****Precision Cutters**

|                               |     |
|-------------------------------|-----|
| DIAGONAL CUTTERS              | 644 |
| DIAGONAL CUTTERS, UNIQUE HEAD | 645 |
| OBLIQUE - END CUTTERS         | 645 |
| ANGLE                         | 646 |
| PLASTIC CUTTERS               | 647 |
| TIP CUTTER                    | 648 |
| OBLIQUE CUTTERS, UNIQUE HEAD  | 648 |
| MICRO TIP CUTTERS             | 648 |
| MULTIPURPOSE SHEARS           | 648 |
| ACCESSORIES & SPARE PARTS     | 649 |

**Precision Cutters for Hard materials**

|  |     |
|--|-----|
| CARBIDE CUTTERS                                    | 649 |
| EXTRA HARDENED DIAGONAL CUTTERS                    | 649 |
| PERFORMANCE SPECIFIC DIAGONAL CUTTERS              | 649 |
| PERFORMANCE SPECIFIC DIAGONAL CUTTERS, UNIQUE HEAD | 650 |

**Precision Holding Pliers**

|                         |     |
|-------------------------|-----|
| FLAT NOSE               | 650 |
| ROUND NOSE              | 650 |
| CHAIN NOSE              | 651 |
| CHAINMAILLE PLIER       | 651 |
| BENT NOSE               | 651 |
| SNIPE NOSE              | 651 |
| SNIPE NOSE, UNIQUE HEAD | 652 |
| NEEDLE NOSE             | 652 |

**Special Cutters**

|  |     |
|--|-----|
| IC INSERTION/EXTRACTION TOOLS & IC CUTTERS | 652 |
| CUT & BEND                                 | 652 |
| STANDOFF CUTTERS                           | 653 |
| CUT & FORM                                 | 653 |
| LEADFORMERS                                | 653 |

**Specials Holding Pliers**

|  |     |
|--|-----|
| IC INSERTION/EXTRACTION TOOLS & IC CUTTERS | 654 |
| LEADFORMERS                                | 654 |

**Shear Cutters**

|              |     |
|--------------|-----|
| TAPERED HEAD | 652 |
| POINTY HEAD  | 653 |
| OBLIQUE HEAD | 653 |

**Precision Screwdrivers**

|          |     |
|----------|-----|
| ESD SAFE | 653 |
|----------|-----|

**Wire Strippers**

|                  |     |
|------------------|-----|
| DIAGONAL CUTTERS | 654 |
|------------------|-----|

**Heavy Duty Cutters**

|                 |     |
|-----------------|-----|
| DIAGONAL CUTTER | 654 |
|-----------------|-----|

**Torque Tools**

|                     |     |
|---------------------|-----|
| TORQUE SCREWDRIVERS | 654 |
|---------------------|-----|

**Tweezers**

|                                   |     |
|-----------------------------------|-----|
| TWEEZER SETS                      | 655 |
| CUTTING TWEEZERS                  | 656 |
| HIGH PRECISION TWEEZERS           | 656 |
| PLASTIC REPLACEABLE TIP TWEEZERS  | 658 |
| ESD SAFE ERGONOMIC TOUCH TWEEZERS | 658 |
| ECONOMY TWEEZERS                  | 659 |
| SMD TWEEZERS                      | 660 |
| COMPONENTS POSITIONING TWEEZERS   | 662 |
| GENERAL PURPOSE TWEEZERS          | 662 |
| SPARE PARTS & ACCESSORIES         | 662 |





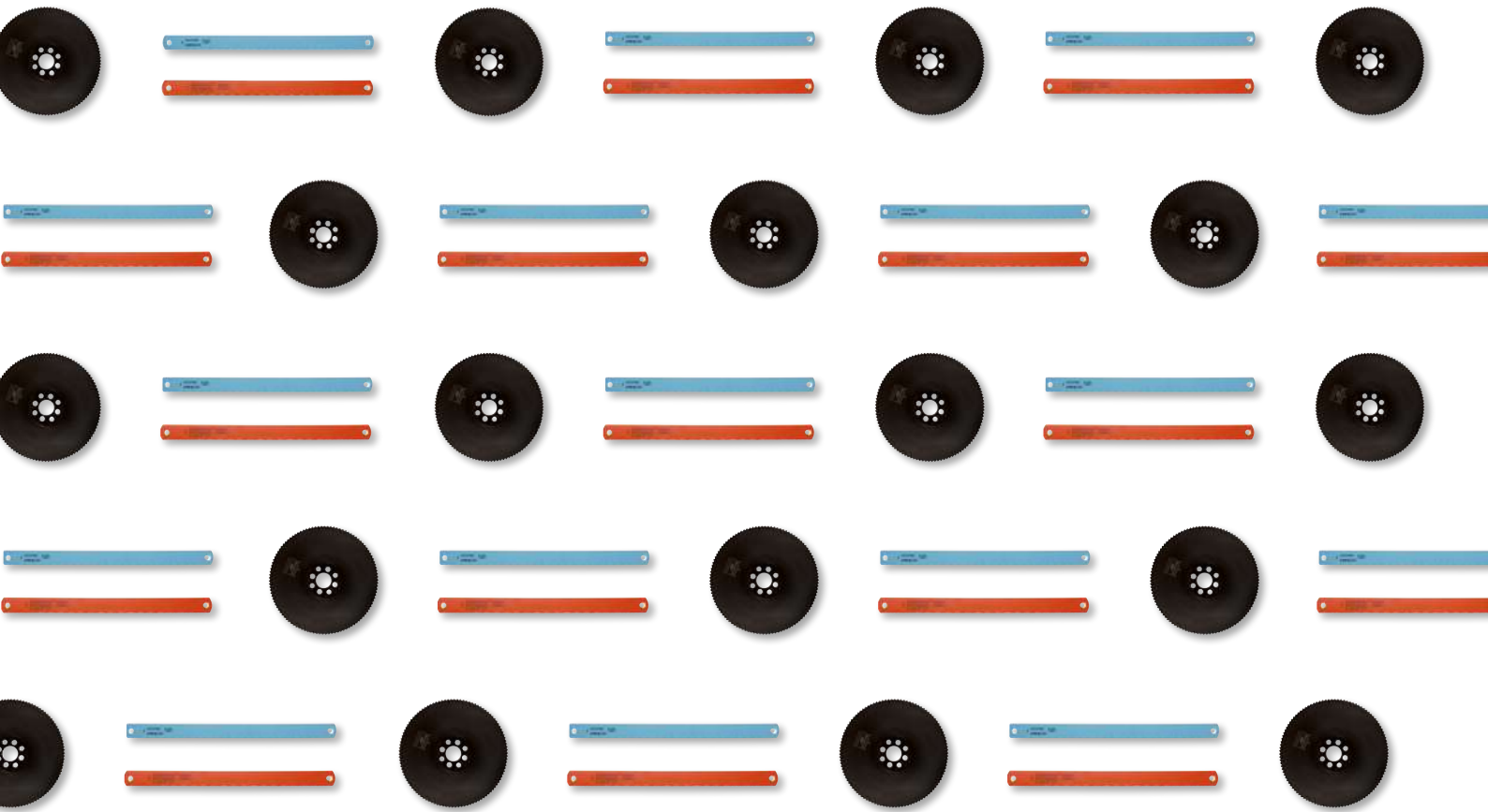

# Bandsaws & Power Saws



## METAL CUTTING BI-METAL BANDSAWS

Universal Bandsaw Blade for Small Workshops

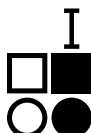

### 3857 Easy-Cut

| Width | Teeth | Material | Part No.         |
|-------|-------|----------|------------------|
| 13 mm | EZ    | 1        | 3857-13-0.6-EZ-S |
| 13 mm | EZ    | 1        | 3857-13-0.6-EZ-M |
| 13 mm | EZ    | 1        | 3857-13-0.6-EZ-L |
| 20 mm | EZ    | 1        | 3857-20-0.9-EZ-S |
| 20 mm | EZ    | 1        | 3857-20-0.9-EZ-M |
| 20 mm | EZ    | 1        | 3857-20-0.9-EZ-L |
| 27 mm | EZ    | 1        | 3857-27-0.9-EZ-S |
| 27 mm | EZ    | 1        | 3857-27-0.9-EZ-M |
| 27 mm | EZ    | 1        | 3857-27-0.9-EZ-L |
| 34 mm | EZ    | 1        | 3857-34-1.1-EZ-S |
| 34 mm | EZ    | 1        | 3857-34-1.1-EZ-M |
| 34 mm | EZ    | 1        | 3857-34-1.1-EZ-L |

General Purpose Metal Cutting Bi-Metal Bandsaw Blade for Contour and Small Machines

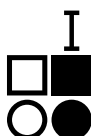

### 3851 Contour and small machine

| Width | Teeth   | Material | Part No.          |
|-------|---------|----------|-------------------|
| 6 mm  | PRX     | 1        | 3851-6-0.6-10/14  |
| 6 mm  | Hook    | 1        | 3851-6-0.6-H-6    |
| 6 mm  | PRX     | 1        | 3851-6-0.9-10/14  |
| 6 mm  | Hook    | 1        | 3851-6-0.9-H-6    |
| 10 mm | PRX     | 1        | 3851-10-0.6-10/14 |
| 10 mm | Hook    | 1        | 3851-10-0.6-H-4   |
| 10 mm | Hook    | 1        | 3851-10-0.6-H-6   |
| 10 mm | PRX     | 1        | 3851-10-0.9-10/14 |
| 10 mm | Hook    | 1        | 3851-10-0.9-H-4   |
| 10 mm | Hook    | 1        | 3851-10-0.9-H-6   |
| 10 mm | Regular | 1        | 3851-10-0.9-R-14  |
| 13 mm | PRX     | 1        | 3851-13-0.5-10/14 |

| Width | Teeth   | Material | Part No.          |
|-------|---------|----------|-------------------|
| 13 mm | PRX     | 1        | 3851-13-0.5-14/18 |
| 13 mm | Regular | 1        | 3851-13-0.5-R-10  |
| 13 mm | Regular | 1        | 3851-13-0.5-R-14  |
| 13 mm | Regular | 1        | 3851-13-0.5-R-18  |
| 13 mm | Regular | 1        | 3851-13-0.5-R-24  |
| 13 mm | Hook    | 1        | 3851-13-0.5-H-4   |
| 13 mm | PRX     | 1        | 3851-13-0.6-10/14 |
| 13 mm | PRX     | 1        | 3851-13-0.6-5/8   |
| 13 mm | PRX     | 1        | 3851-13-0.6-6/10  |
| 13 mm | PRX     | 1        | 3851-13-0.6-8/12  |
| 13 mm | Hook    | 1        | 3851-13-0.6-H-3   |
| 13 mm | Hook    | 1        | 3851-13-0.6-H-4   |
| 13 mm | Hook    | 1        | 3851-13-0.6-H-6   |
| 13 mm | Regular | 1        | 3851-13-0.6-R-10  |
| 13 mm | Regular | 1        | 3851-13-0.6-R-14  |
| 13 mm | Regular | 1        | 3851-13-0.6-R-18  |
| 13 mm | PRX     | 1        | 3851-13-0.9-10/14 |
| 13 mm | PRX     | 1        | 3851-13-0.9-6/10  |
| 13 mm | Hook    | 1        | 3851-13-0.9-H-3   |
| 13 mm | Hook    | 1        | 3851-13-0.9-H-4   |
| 13 mm | Hook    | 1        | 3851-13-0.9-H-6   |
| 13 mm | Regular | 1        | 3851-13-0.9-R-14  |
| 13 mm | Regular | 1        | 3851-13-0.9-R-6   |
| 20 mm | PRX     | 1        | 3851-20-0.9-10/14 |
| 20 mm | Hook    | 1        | 3851-20-0.9-H-3   |
| 20 mm | Hook    | 1        | 3851-20-0.9-H-4   |
| 20 mm | Regular | 1        | 3851-20-0.9-R-18  |
| 20 mm | PRX     | 1        | 3851-20-0.9-4/6   |
| 20 mm | PRX     | 1        | 3851-20-0.9-5/8   |
| 20 mm | PRX     | 1        | 3851-20-0.9-6/10  |
| 20 mm | PRX     | 1        | 3851-20-0.9-8/12  |
| 27 mm | PS      | 1        | 3851-27-0.9-P-3   |
| 27 mm | PS      | 1        | 3851-27-0.9-P-4   |
| 27 mm | Regular | 1        | 3851-27-0.9-R-6   |
| 34 mm | PS      | 1        | 3851-34-1.1-P-2   |
| 34 mm | PS      | 1        | 3851-34-1.1-P-3   |

Foundry Bandsaw Blade



### 3851 Sandflex® Cobra™ Foundry

| Width | Teeth | Material | Part No.         |
|-------|-------|----------|------------------|
| 10 mm | HA    | 1        | 3851-10-0.6-HA-4 |
| 13 mm | HA    | 1        | 3851-13-0.6-HA-4 |
| 13 mm | HA    | 1        | 3851-13-0.6-HA-6 |
| 13 mm | HA    | 1        | 3851-13-0.9-HA-4 |
| 20 mm | HA    | 1        | 3851-20-0.9-HA-3 |
| 20 mm | HA    | 1        | 3851-20-0.9-HA-4 |
| 27 mm | HA    | 1        | 3851-27-0.9-HA-4 |
| 27 mm | HA    | 1        | 3851-27-0.9-HA-3 |



Production Metal Cutting Bi-Metal Bandsaw Blade for High Performance



**3851 Sandflex® Cobra™**



| 27 mm | PRX | 1 | 3851-27-0.9-2/3    |
|-------|-----|---|--------------------|
| 27 mm | PRX | 1 | 3851-27-0.9-3/4    |
| 27 mm | PRX | 1 | 3851-27-0.9-4/6    |
| 27 mm | PRX | 1 | 3851-27-0.9-5/8    |
| 27 mm | PRX | 1 | 3851-27-0.9-6/10   |
| 27 mm | PRX | 1 | 3851-27-0.9-8/12   |
| 27 mm | PRX | 1 | 3851-27-0.9-10/14  |
| 34 mm | PRX | 1 | 3851-34-1.1-2/3    |
| 34 mm | PRX | 1 | 3851-34-1.1-3/4    |
| 34 mm | PRX | 1 | 3851-34-1.1-4/6    |
| 34 mm | PRX | 1 | 3851-34-1.1-5/8    |
| 34 mm | PRX | 1 | 3851-34-1.1-6/10   |
| 41 mm | PRX | 1 | 3851-41-1.3-1.4/2  |
| 41 mm | PRX | 1 | 3851-41-1.3-2/3    |
| 41 mm | PRX | 1 | 3851-41-1.3-3/4    |
| 41 mm | PRX | 1 | 3851-41-1.3-4/6    |
| 41 mm | PRX | 1 | 3851-41-1.3-5/8    |
| 54 mm | PRX | 1 | 3851-54-1.3-1.4/2  |
| 54 mm | PRX | 1 | 3851-54-1.3-2/3    |
| 54 mm | PRX | 1 | 3851-54-1.3-3/4    |
| 54 mm | PRX | 1 | 3851-54-1.3-4/6    |
| 54 mm | PR  | 1 | 3851-54-1.6-P-1.25 |
| 54 mm | PRX | 1 | 3851-54-1.6-1/1.4  |
| 54 mm | PRX | 1 | 3851-54-1.6-1.4/2  |
| 54 mm | PRX | 1 | 3851-54-1.6-2/3    |
| 54 mm | PRX | 1 | 3851-54-1.6-3/4    |
| 54 mm | PRX | 1 | 3851-54-1.6-4/6    |
| 67 mm | PRX | 1 | 3851-67-1.6-7/1    |
| 67 mm | PRX | 1 | 3851-67-1.6-1/1.4  |
| 67 mm | PRX | 1 | 3851-67-1.6-1.4/2  |
| 67 mm | PRX | 1 | 3851-67-1.6-2/3    |
| 67 mm | PRX | 1 | 3851-67-1.6-3/4    |
| 67 mm | PRX | 1 | 3851-67-1.6-4/6    |
| 80 mm | PRX | 1 | 3851-80-1.6-7/1    |
| 80 mm | PRX | 1 | 3851-80-1.6-1/1.4  |
| 80 mm | PRX | 1 | 3851-80-1.6-1.4/2  |

Unique Design Bandsaw Blade for Tool Steels and Hard Materials

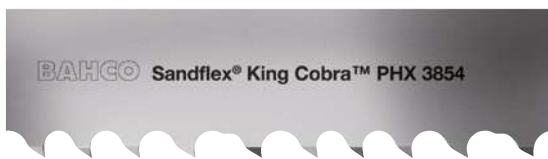

**3854-Sandflex® King Cobra™ PHX**



| 27 mm | PHX | 1 | 3854-27-0.9-PHX-2/3 |
|-------|-----|---|---------------------|
| 27 mm | PHX | 1 | 3854-27-0.9-PHX-3/4 |
| 27 mm | PHX | 1 | 3854-27-0.9-PHX-4/6 |

| 34 mm | PHX | 1 | 3854-34-1.1-PHX-1.4/2 |
|-------|-----|---|-----------------------|
| 34 mm | PHX | 1 | 3854-34-1.1-PHX-2/3   |
| 34 mm | PHX | 1 | 3854-34-1.1-PHX-3/4   |
| 34 mm | PHX | 1 | 3854-34-1.1-PHX-4/6   |
| 41 mm | PHX | 1 | 3854-41-1.3-PHX-1.4/2 |
| 41 mm | PHX | 1 | 3854-41-1.3-PHX-2/3   |
| 41 mm | PHX | 1 | 3854-41-1.3-PHX-3/4   |
| 41 mm | PHX | 1 | 3854-41-1.3-PHX-4/6   |
| 54 mm | PHX | 1 | 3854-54-1.3-PHX-1.4/2 |
| 54 mm | PHX | 1 | 3854-54-1.3-PHX-2/3   |
| 54 mm | PHX | 1 | 3854-54-1.3-PHX-3/4   |
| 54 mm | PHX | 1 | 3854-54-1.6-PHX-7/1   |
| 54 mm | PHX | 1 | 3854-54-1.6-PHX-1/1.4 |
| 54 mm | PHX | 1 | 3854-54-1.6-PHX-1.4/2 |
| 54 mm | PHX | 1 | 3854-54-1.6-PHX-2/3   |
| 54 mm | PHX | 1 | 3854-54-1.6-PHX-3/4   |
| 67 mm | PHX | 1 | 3854-67-1.6-PHX-7/1   |
| 67 mm | PHX | 1 | 3854-67-1.6-PHX-1/1.4 |
| 67 mm | PHX | 1 | 3854-67-1.6-PHX-1.4/2 |
| 67 mm | PHX | 1 | 3854-67-1.6-PHX-2/3   |
| 80 mm | PHX | 1 | 3854-80-1.6-PHX-7/1   |
| 80 mm | PHX | 1 | 3854-80-1.6-PHX-1/1.4 |
| 80 mm | PHX | 1 | 3854-80-1.6-PHX-1.4/2 |

Production Metal Cutting Bi-Metal Bandsaw Blade for Special and Difficult Alloys



**3854-Sandflex® King Cobra™ PQ**



| 27 mm | PQ | 1 | 3854-27-0.9-PQ-3/4   |
|-------|----|---|----------------------|
| 27 mm | PQ | 1 | 3854-27-0.9-PQ-4/6   |
| 34 mm | PQ | 1 | 3854-34-1.1-PQ-2/3   |
| 34 mm | PQ | 1 | 3854-34-1.1-PQ-3/4   |
| 34 mm | PQ | 1 | 3854-34-1.1-PQ-4/6   |
| 41 mm | PQ | 1 | 3854-41-1.3-PQ-1.4/2 |
| 41 mm | PQ | 1 | 3854-41-1.3-PQ-2/3   |
| 41 mm | PQ | 1 | 3854-41-1.3-PQ-3/4   |
| 41 mm | PQ | 1 | 3854-41-1.3-PQ-4/6   |
| 54 mm | PQ | 1 | 3854-54-1.6-PQ-9/1.2 |
| 54 mm | PQ | 1 | 3854-54-1.6-PQ-1.4/2 |
| 54 mm | PQ | 1 | 3854-54-1.6-PQ-2/3   |
| 54 mm | PQ | 1 | 3854-54-1.6-PQ-3/4   |
| 54 mm | PQ | 1 | 3854-54-1.6-PQ-4/6   |
| 67 mm | PQ | 1 | 3854-67-1.6-PQ-9/1.2 |
| 67 mm | PQ | 1 | 3854-67-1.6-PQ-1.4/2 |
| 67 mm | PQ | 1 | 3854-67-1.6-PQ-2/3   |
| 80 mm | PQ | 1 | 3854-80-1.6-PQ-9/1.2 |
| 80 mm | PQ | 1 | 3854-80-1.6-PQ-1.4/2 |



Production Metal Cutting Bi-Metal Bandsaw Blade for Special and Difficult Alloys



**3858 PQ P9000**

| Width | Grade | Quantity | Part Number          |
|-------|-------|----------|----------------------|
| 41 mm | PQ    | 1        | 3858-41-1.3-PQ-1.4/2 |
| 41 mm | PQ    | 1        | 3858-41-1.3-PQ-2/3   |
| 41 mm | PQ    | 1        | 3858-41-1.3-PQ-3/4   |
| 54 mm | PQ    | 1        | 3858-54-1.6-PQ-9/1.2 |
| 54 mm | PQ    | 1        | 3858-54-1.6-PQ-1.4/2 |
| 54 mm | PQ    | 1        | 3858-54-1.6-PQ-2/3   |
| 67 mm | PQ    | 1        | 3858-67-1.6-PQ-9/1.2 |
| 67 mm | PQ    | 1        | 3858-67-1.6-PQ-1.4/2 |
| 80 mm | PQ    | 1        | 3858-80-1.6-PQ-9/1.2 |

Unique Design Bandsaw Blade for Tool Steels and Hard Materials for Better Blade Life



**3858 PHX P9000**

| Width | Grade | Quantity | Part Number           |
|-------|-------|----------|-----------------------|
| 34 mm | PHX   | 1        | 3858-34-1.1-PHX-1.4/2 |
| 34 mm | PHX   | 1        | 3858-34-1.1-PHX-2/3   |
| 34 mm | PHX   | 1        | 3858-34-1.1-PHX-3/4   |
| 41 mm | PHX   | 1        | 3858-41-1.3-PHX-1.4/2 |
| 41 mm | PHX   | 1        | 3858-41-1.3-PHX-2/3   |
| 41 mm | PHX   | 1        | 3858-41-1.3-PHX-3/4   |
| 54 mm | PHX   | 1        | 3858-54-1.3-PHX-1.4/2 |
| 54 mm | PHX   | 1        | 3858-54-1.3-PHX-2/3   |
| 54 mm | PHX   | 1        | 3858-54-1.3-PHX-3/4   |
| 54 mm | PHX   | 1        | 3858-54-1.6-PHX-7/1   |
| 54 mm | PHX   | 1        | 3858-54-1.6-PHX-1/1.4 |
| 54 mm | PHX   | 1        | 3858-54-1.6-PHX-1.4/2 |
| 54 mm | PHX   | 1        | 3858-54-1.6-PHX-2/3   |
| 54 mm | PHX   | 1        | 3858-54-1.6-PHX-3/4   |
| 67 mm | PHX   | 1        | 3858-67-1.6-PHX-7/1   |
| 67 mm | PHX   | 1        | 3858-67-1.6-PHX-1/1.4 |
| 67 mm | PHX   | 1        | 3858-67-1.6-PHX-1.4/2 |
| 67 mm | PHX   | 1        | 3858-67-1.6-PHX-2/3   |
| 80 mm | PHX   | 1        | 3858-80-1.6-PHX-7/1   |
| 80 mm | PHX   | 1        | 3858-80-1.6-PHX-1/1.4 |
| 80 mm | PHX   | 1        | 3858-80-1.6-PHX-1.4/2 |

Sandflex® Top Fabricator Bandsaw Blades



**3853 Sandflex® Top Fabricator**

| Width | Grade | Quantity | Part Number         |
|-------|-------|----------|---------------------|
| 20 mm | PF    | 1        | 3853-20-0.9-5/7-VS  |
| 20 mm | PF    | 1        | 3853-20-0.9-8/11-VS |
| 27 mm | PF    | 1        | 3853-27-0.9-3/4     |
| 27 mm | PF    | 1        | 3853-27-0.9-4/6     |
| 27 mm | PF    | 1        | 3853-27-0.9-5/8     |
| 27 mm | PF    | 1        | 3853-27-0.9-8/11-VS |
| 27 mm | PF    | 1        | 3853-27-0.9-8/11-VS |
| 34 mm | PF    | 1        | 3853-34-1.1-2/3     |
| 34 mm | PF    | 1        | 3853-34-1.1-3/4     |
| 34 mm | PF    | 1        | 3853-34-1.1-4/6     |
| 34 mm | PF    | 1        | 3853-34-1.1-5/8     |
| 34 mm | PF    | 1        | 3853-34-1.1-5/7-VS  |
| 34 mm | PF    | 1        | 3853-34-1.1-8/11-VS |
| 41 mm | PF    | 1        | 3853-41-1.3-2/3     |
| 41 mm | PF-W  | 1        | 3853-41-1.3-2/3-W   |
| 41 mm | PF    | 1        | 3853-41-1.3-3/4     |
| 41 mm | PF-W  | 1        | 3853-41-1.3-3/4-W   |
| 41 mm | PF    | 1        | 3853-41-1.3-4/6     |
| 41 mm | PF    | 1        | 3853-41-1.3-5/8     |
| 41 mm | PF    | 1        | 3853-41-1.3-5/7-VS  |
| 54 mm | PF    | 1        | 3853-54-1.3-3/4     |
| 54 mm | PF    | 1        | 3853-54-1.3-3/4-W   |
| 54 mm | PF    | 1        | 3853-54-1.3-5/8     |
| 54 mm | PF    | 1        | 3853-54-1.6-2/3     |
| 54 mm | PF-W  | 1        | 3853-54-1.6-2/3-W   |
| 54 mm | PF    | 1        | 3853-54-1.6-3/4     |
| 54 mm | PF-W  | 1        | 3853-54-1.6-3/4-W   |
| 54 mm | PF    | 1        | 3853-54-1.6-4/6     |
| 67 mm | PF    | 1        | 3853-67-1.6-2/3     |
| 67 mm | PF-W  | 1        | 3853-67-1.6-2/3-W   |
| 67 mm | PF    | 1        | 3853-67-1.6-3/4     |
| 67 mm | PF-W  | 1        | 3853-67-1.6-3/4-W   |
| 67 mm | PF-W  | 1        | 3853-67-1.6-5/8-W   |

Sandflex® Top Fabricator Coated Bandsaw Blades



**3853 Sandflex® Top Fabricator Coated**

| Width | Grade | Quantity | Part Number        |
|-------|-------|----------|--------------------|
| 41 mm | PF    | 1        | 3853-41-1.3-2/3-WS |
| 41 mm | PF    | 1        | 3853-41-1.3-3/4-WS |
| 54 mm | PF    | 1        | 3853-54-1.6-2/3-WS |
| 54 mm | PF    | 1        | 3853-54-1.6-3/4-WS |
| 67 mm | PF    | 1        | 3853-67-1.6-2/3-WS |
| 67 mm | PF    | 1        | 3853-67-1.6-3/4-WS |

## METAL CUTTING TRI-METAL BANDSAWS

Extreme Easy-Cut Carbide Bandsaw Blades



### 3859 Carbide Easy-Cut EZX

| 27 mm | EZX | 1 | 3859-27-0.9-EZX-3/4    |
|-------|-----|---|------------------------|
| 27 mm | EZX | 1 | 3859-27-0.9-EZX-4/6    |
| 34 mm | EZX | 1 | 3859-34-1.1-EZX-2/3    |
| 34 mm | EZX | 1 | 3859-34-1.1-EZX-3/4    |
| 34 mm | EZX | 1 | 3859-34-1.1-EZX-4/6    |
| 41 mm | EZX | 1 | 3859-41-1.3-EZX-1.4/2  |
| 41 mm | EZX | 1 | 3859-41-1.3-EZX-2/3    |
| 41 mm | EZX | 1 | 3859-41-1.3-EZX-3/4    |
| 41 mm | EZX | 1 | 3859-41-1.3-EZX-4/6    |
| 54 mm | EZX | 1 | 3859-54-1.6-EZX-1.4/2  |
| 54 mm | EZX | 1 | 3859-54-1.6-EZX-1/1.25 |
| 54 mm | EZX | 1 | 3859-54-1.6-EZX-2/3    |
| 54 mm | EZX | 1 | 3859-54-1.6-EZX-3/4    |
| 54 mm | EZX | 1 | 3859-54-1.6-EZX-4/6    |
| 67 mm | EZX | 1 | 3859-67-1.6-EZX-7/1    |
| 67 mm | EZX | 1 | 3859-67-1.6-EZX-1.4/2  |
| 67 mm | EZX | 1 | 3859-67-1.6-EZX-1/1.25 |
| 67 mm | EZX | 1 | 3859-67-1.6-EZX-2/3    |
| 80 mm | EZX | 1 | 3859-80-1.6-EZX-7/1    |
| 80 mm | EZX | 1 | 3859-80-1.6-EZX-1.4/2  |
| 80 mm | EZX | 1 | 3859-80-1.6-EZX-1/1.25 |

## METAL CUTTING CARBIDE BANDSAWS

Foundry Bandsaw Blade

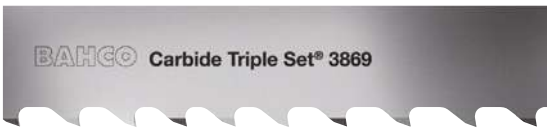

### 3869 Carbide Triple Set®

| 13 mm | TS | 1 | 3869-13-0.9-TS-3 |
|-------|----|---|------------------|
| 20 mm | TS | 1 | 3869-20-0.9-TS-3 |
| 20 mm | TS | 1 | 3869-20-0.9-TS-4 |
| 27 mm | TS | 1 | 3869-27-0.9-TS-3 |
| 27 mm | TS | 1 | 3869-27-0.9-TS-4 |
| 34 mm | TS | 1 | 3869-34-1.1-TS-2 |
| 34 mm | TS | 1 | 3869-34-1.1-TS-3 |

Versatile Carbide Bandsaw Blade



### 3868 Carbide Triple Set® TSX

| 27 mm | TSX | 1 | 3868-27-0.9-TSX-3/4    |
|-------|-----|---|------------------------|
| 34 mm | TSX | 1 | 3868-34-1.1-TSX-2      |
| 34 mm | TSX | 1 | 3868-34-1.1-TSX-2/3    |
| 34 mm | TSX | 1 | 3868-34-1.1-TSX-3/4    |
| 41 mm | TSX | 1 | 3868-41-1.3-TSX-1.4/2  |
| 41 mm | TSX | 1 | 3868-41-1.3-TSX-1.6    |
| 41 mm | TSX | 1 | 3868-41-1.3-TSX-2      |
| 41 mm | TSX | 1 | 3868-41-1.3-TSX-2/3    |
| 41 mm | TSX | 1 | 3868-41-1.3-TSX-3/4    |
| 54 mm | TSX | 1 | 3868-54-1.3-TSX-1.4/2  |
| 54 mm | TSX | 1 | 3868-54-1.3-TSX-2/3    |
| 54 mm | TSX | 1 | 3868-54-1.6-TSX-1/1.25 |
| 54 mm | TSX | 1 | 3868-54-1.6-TSX-1.4/2  |
| 54 mm | TSX | 1 | 3868-54-1.6-TSX-1.6    |
| 54 mm | TSX | 1 | 3868-54-1.6-TSX-2/3    |
| 54 mm | TSX | 1 | 3868-54-1.6-TSX-3/4    |
| 67 mm | TSX | 1 | 3868-67-1.6-TSX-7/1    |
| 67 mm | TSX | 1 | 3868-67-1.6-TSX-1/1.25 |
| 67 mm | TSX | 1 | 3868-67-1.6-TSX-1.4/2  |
| 67 mm | TSX | 1 | 3868-67-1.6-TSX-2/3    |
| 80 mm | TSX | 1 | 3868-80-1.1-TSX-3/4    |
| 80 mm | TSX | 1 | 3868-80-1.6-TSX-7/1    |
| 80 mm | TSX | 1 | 3868-80-1.6-TSX-1/1.25 |
| 80 mm | TSX | 1 | 3868-80-1.6-TSX-1.4/2  |
| 80 mm | TSX | 1 | 3868-80-1.6-TSX-2/3    |

Versatile Honed Carbide Bandsaw Blade



### 3868 Carbide Triple Set® TSS

| 27 mm | TSS | 1 | 3868-27-0.9-TSS-3/4    |
|-------|-----|---|------------------------|
| 34 mm | TSS | 1 | 3868-34-1.1-TSS-2/3    |
| 34 mm | TSS | 1 | 3868-34-1.1-TSS-3/4    |
| 41 mm | TSS | 1 | 3868-41-1.3-TSS-1.4/2  |
| 41 mm | TSS | 1 | 3868-41-1.3-TSS-2/3    |
| 54 mm | TSS | 1 | 3868-54-1.6-TSS-1/1.25 |
| 54 mm | TSS | 1 | 3868-54-1.6-TSS-1.4/2  |
| 54 mm | TSS | 1 | 3868-54-1.6-TSS-2/3    |
| 67 mm | TSS | 1 | 3868-67-1.6-TSS-7/1    |
| 67 mm | TSS | 1 | 3868-67-1.6-TSS-1/1.25 |
| 67 mm | TSS | 1 | 3868-67-1.6-TSS-1.4/2  |
| 67 mm | TSS | 1 | 3868-67-1.6-TSS-2/3    |
| 80 mm | TSS | 1 | 3868-80-1.6-TSS-7/1    |
| 80 mm | TSS | 1 | 3868-80-1.6-TSS-1.4/2  |
| 80 mm | TSS | 1 | 3868-80-1.6-TSS-2/3    |



## Advanced Carbide Bandsaw Blade



### 3881 Carbide Multi Set THQ

| 34 mm | THQ | 1 | 3881-34-1.1-THQ-2/3    |
|-------|-----|---|------------------------|
| 41 mm | THQ | 1 | 3881-41-1.3-THQ-1.4/2  |
| 41 mm | THQ | 1 | 3881-41-1.3-THQ-2/3    |
| 54 mm | THQ | 1 | 3881-54-1.6-THQ-1.4/2  |
| 54 mm | THQ | 1 | 3881-54-1.6-THQ-1/1.25 |
| 54 mm | THQ | 1 | 3881-54-1.6-THQ-2/3    |
| 67 mm | THQ | 1 | 3881-67-1.6-THQ-1/1.25 |
| 67 mm | THQ | 1 | 3881-67-1.6-THQ-1.4/2  |
| 67 mm | THQ | 1 | 3881-67-1.6-THQ-2/3    |
| 80 mm | THQ | 1 | 3881-80-1.6-THQ-7/1    |
| 80 mm | THQ | 1 | 3881-80-1.6-THQ-1/1.25 |
| 80 mm | THQ | 1 | 3881-80-1.6-THQ-1.4/2  |
| 80 mm | THQ | 1 | 3881-80-1.6-THQ-2/3    |

## Advanced Honed Carbide Bandsaw Blade



### 3881 Carbide Multi Set THS

| 41 mm  | THS | 1 | 3881-41-1.3-THS-1.4/2  |
|--------|-----|---|------------------------|
| 54 mm  | THS | 1 | 3881-54-1.6-THS-1/1.25 |
| 54 mm  | THS | 1 | 3881-54-1.6-THS-1.4/2  |
| 67 mm  | THS | 1 | 3881-67-1.6-THS-1/1.25 |
| 67 mm  | THS | 1 | 3881-67-1.6-THS-1.4/2  |
| 67 mm  | THS | 1 | 3881-67-1.6-THS-2/3    |
| 80 mm  | THS | 1 | 3881-80-1.6-THS-7/1    |
| 80 mm  | THS | 1 | 3881-80-1.6-THS-1.4/2  |
| 80 mm  | THS | 1 | 3881-80-1.6-THS-2/3    |
| 100 mm | THS | 1 | 3881-100-1.6-THS-7/1   |

## Most Advanced Carbide Bandsaw Blade



### 3860 Unset Carbide TMC

| 41 mm | TMC | 1 | 3860-41-1.3-TMC-1.4/2 |
|-------|-----|---|-----------------------|
| 41 mm | TMC | 1 | 3860-41-1.3-TMC-2/3   |
| 54 mm | TMC | 1 | 3860-54-1.3-TMC-1.4/2 |

| 54 mm  | TMC | 1 | 3860-54-1.3-TMC-2/3    |
|--------|-----|---|------------------------|
| 54 mm  | TMC | 1 | 3860-54-1.6-TMC-7/1    |
| 54 mm  | TMC | 1 | 3860-54-1.6-TMC-1/1.25 |
| 54 mm  | TMC | 1 | 3860-54-1.6-TMC-1.4/2  |
| 54 mm  | TMC | 1 | 3860-54-1.6-TMC-2/3    |
| 67 mm  | TMC | 1 | 3860-67-1.6-TMC-1/1.25 |
| 67 mm  | TMC | 1 | 3860-67-1.6-TMC-1.4/2  |
| 67 mm  | TMC | 1 | 3860-67-1.6-TMC-2/3    |
| 80 mm  | TMC | 1 | 3860-80-1.1-TMC-1.4/2  |
| 80 mm  | TMC | 1 | 3860-80-1.6-TMC-7/1    |
| 80 mm  | TMC | 1 | 3860-80-1.6-TMC-1/1.25 |
| 80 mm  | TMC | 1 | 3860-80-1.6-TMC-1.4/2  |
| 80 mm  | TMC | 1 | 3860-80-1.6-TMC-2/3    |
| 100 mm | TMC | 1 | 3860-100-1.1-TMC-1.4/2 |

## Versatile Carbide Bandsaw Blade



### 3860 Unset Carbide TCD

| 27 mm | TCD | 1 | 3860-27-0.9-TCD-3       |
|-------|-----|---|-------------------------|
| 27 mm | TCD | 1 | 3860-27-0.9-TCD-3/4     |
| 34 mm | TCD | 1 | 3860-34-1.1-TCD-2/3     |
| 34 mm | TCD | 1 | 3860-34-1.1-TCD-3/4     |
| 34 mm | TCD | 1 | 3860-34-1.1-TCD-3/4-W   |
| 41 mm | TCD | 1 | 3860-41-1.3-TCD-1.4/2   |
| 41 mm | TCD | 1 | 3860-41-1.3-TCD-1.9/2.1 |
| 41 mm | TCD | 1 | 3860-41-1.3-TCD-2/3     |
| 41 mm | TCD | 1 | 3860-41-1.3-TCD-3/4     |
| 54 mm | TCD | 1 | 3860-54-1.6-TCD-1.4/2   |
| 54 mm | TCD | 1 | 3860-54-1.6-TCD-1.9/2.1 |
| 54 mm | TCD | 1 | 3860-54-1.6-TCD-2/3     |
| 54 mm | TCD | 1 | 3860-54-1.6-TCD-3/4     |
| 67 mm | TCD | 1 | 3860-67-1.6-TCD-1.4/2   |
| 67 mm | TCD | 1 | 3860-67-1.6-TCD-1/1.25  |
| 80 mm | TCD | 1 | 3860-80-1.6-TCD-5/0.8   |

## Bandsaw Blade for Induction Hardened Bars



### 3860 Unset Carbide TCZ

| 27 mm | TCZ | 1 | 3860-27-0.9-TCZ-3/4 |
|-------|-----|---|---------------------|
| 34 mm | TCZ | 1 | 3860-34-1.1-TCZ-2/3 |
| 34 mm | TCZ | 1 | 3860-34-1.1-TCZ-3/4 |
| 41 mm | TCZ | 1 | 3860-41-1.3-TCZ-2/3 |
| 41 mm | TCZ | 1 | 3860-41-1.3-TCZ-3/4 |

## Coated TMC Multi Chip Unset Carbide Bandsaw Blades



### 3860 Unset Carbide TMC Coated

| Width | Material | Quantity | Part Number             |
|-------|----------|----------|-------------------------|
| 54 mm | TMC      | 1        | 3860-54-1.6-TMC-1/1.25S |
| 54 mm | TMC      | 1        | 3860-54-1.6-TMC-1.4/2S  |
| 54 mm | TMC      | 1        | 3860-54-1.6-TMC-2/3S    |
| 67 mm | TMC      | 1        | 3860-67-1.6-TMC-1/1.25S |
| 67 mm | TMC      | 1        | 3860-67-1.6-TMC-1.4/2S  |

## WOOD CUTTING BANDSAW

Bi-metal Bandsaw Blade for Longer Life



### 3861 Sandcut Bi-metal

| Width | Material | Quantity | Part Number        |
|-------|----------|----------|--------------------|
| 4     | Hook     | 1        | 3861-20-0.6-H-4    |
| 1.33  | Hook     | 1        | 3861-27-0.9-H-1.33 |
| 1.15  | Hook     | 1        | 3861-34-0.9-H-1.15 |
| 1.15  | Hook     | 1        | 3861-34-1.1-H-1.15 |
| 1.15  | Hook     | 1        | 3861-41-1.1-H-1.15 |
| 1.15  | Hook     | 1        | 3861-54-1.1-H-1.15 |

Standard Bandsaw Blade



### 3862 Sandcut Solid

| Width | Material | Quantity | Part Number        |
|-------|----------|----------|--------------------|
| 1.15  | Hook     | 1        | 3862-33-0.9-H-1.15 |
| 1.15  | Hook     | 1        | 3862-33-1.1-H-1.15 |
| 1.15  | Hook     | 1        | 3862-40-1.1-H-1.15 |

## INSULATION CUTTING BANDSAWS

Sandflex® Twin Tip Insulation Bandsaw Blades



### 3852 Sandflex® Twin Tip Insulation

| Width | Material | Quantity | Part Number       |
|-------|----------|----------|-------------------|
| 27 mm | INS      | 1        | 3852-27-0.9-INS-3 |
| 34 mm | INS      | 1        | 3852-34-1.1-INS-3 |

## HSS CIRCULAR SAWBLADES

HSS Circular Saw Blades with 32-1 Bore



### 3815-32-1

| Width  | Material | Quantity | Part Number            |
|--------|----------|----------|------------------------|
| 200 mm | BW3      | 1        | 3815-200-2,0-32-1-03BW |
| 200 mm | BW4      | 1        | 3815-200-2,0-32-1-04BW |
| 225 mm | BW3      | 1        | 3815-225-2,0-32-1-03BW |
| 225 mm | BW4      | 1        | 3815-225-2,0-32-1-04BW |
| 225 mm | BW5      | 1        | 3815-225-2,0-32-1-05BW |
| 225 mm | C6       | 1        | 3815-225-2,0-32-1-06C  |
| 250 mm | BW3      | 1        | 3815-250-2,0-32-1-03BW |
| 250 mm | BW4      | 1        | 3815-250-2,0-32-1-04BW |
| 250 mm | BW5      | 1        | 3815-250-2,0-32-1-05BW |
| 250 mm | C6       | 1        | 3815-250-2,0-32-1-06C  |
| 275 mm | BW4      | 1        | 3815-275-2,5-32-1-04BW |
| 275 mm | BW5      | 1        | 3815-275-2,5-32-1-05BW |
| 275 mm | C6       | 1        | 3815-275-2,5-32-1-06C  |
| 275 mm | C8       | 1        | 3815-275-2,5-32-1-08C  |
| 300 mm | BW4      | 1        | 3815-300-2,5-32-1-04BW |
| 300 mm | BW5      | 1        | 3815-300-2,5-32-1-05BW |
| 300 mm | C5       | 1        | 3815-300-2,5-32-1-05C  |
| 300 mm | C6       | 1        | 3815-300-2,5-32-1-06C  |
| 300 mm | C8       | 1        | 3815-300-2,5-32-1-08C  |
| 315 mm | BW4      | 1        | 3815-315-2,5-32-1-04BW |
| 315 mm | BW5      | 1        | 3815-315-2,5-32-1-05BW |
| 315 mm | C6       | 1        | 3815-315-2,5-32-1-06C  |
| 315 mm | C8       | 1        | 3815-315-2,5-32-1-08C  |
| 350 mm | BW4      | 1        | 3815-350-2,5-32-1-04BW |
| 350 mm | C6       | 1        | 3815-350-2,5-32-1-06C  |



## HSS Circular Saw Blades with 40-2 Bore



### 3815-40-2

| Ø      | V   |   |                        |
|--------|-----|---|------------------------|
| 250 mm | BW3 | 1 | 3815-250-2.0-40-2-03BW |
| 250 mm | BW4 | 1 | 3815-250-2.0-40-2-04BW |
| 250 mm | BW5 | 1 | 3815-250-2.0-40-2-05BW |
| 275 mm | BW3 | 1 | 3815-275-2.5-40-2-03BW |
| 275 mm | BW4 | 1 | 3815-275-2.5-40-2-04BW |
| 275 mm | BW5 | 1 | 3815-275-2.5-40-2-05BW |
| 275 mm | C6  | 1 | 3815-275-2.5-40-2-06C  |
| 275 mm | C8  | 1 | 3815-275-2.5-40-2-08C  |
| 315 mm | BW4 | 1 | 3815-315-2.5-40-2-04BW |
| 315 mm | BW5 | 1 | 3815-315-2.5-40-2-05BW |
| 315 mm | C6  | 1 | 3815-315-3.0-40-2-06C  |

## HSS Circular Saw Blades with 50-4 Bore



### 3815-50-4

| Ø      | V   |   |                       |
|--------|-----|---|-----------------------|
| 370 mm | C8  | 1 | 3815-370-3.0-50-4-08C |
| 370 mm | C10 | 1 | 3815-370-3.0-50-4-10C |
| 400 mm | C10 | 1 | 3815-400-3.5-50-4-10C |

## POWER HACKSAW BLADES

### Sandflex® Bi-Metal Power Hacksaw Blades



### 3809

| Ø  | L      |    |                     |
|----|--------|----|---------------------|
| 10 | 300 mm | 10 | 3809-300-25-1.25-10 |
| 14 | 300 mm | 10 | 3809-300-25-1.25-14 |
| 6  | 300 mm | 10 | 3809-300-32-1.60-6  |





| Ø  | L      |    |                     |
|----|--------|----|---------------------|
| 10 | 300 mm | 10 | 3809-300-32-1.60-10 |
| 6  | 350 mm | 10 | 3809-350-25-1.25-6  |
| 10 | 350 mm | 10 | 3809-350-25-1.25-10 |
| 14 | 350 mm | 10 | 3809-350-25-1.25-14 |
| 4  | 350 mm | 10 | 3809-350-32-1.60-4  |
| 6  | 350 mm | 10 | 3809-350-32-1.60-6  |
| 8  | 350 mm | 10 | 3809-350-32-1.60-8  |
| 10 | 350 mm | 10 | 3809-350-32-1.60-10 |
| 14 | 350 mm | 10 | 3809-350-32-1.60-14 |
| 4  | 350 mm | 10 | 3809-350-32-2.00-4  |
| 6  | 350 mm | 10 | 3809-350-32-2.00-6  |
| 10 | 350 mm | 10 | 3809-350-32-2.00-10 |
| 6  | 350 mm | 10 | 3809-350-38-2.00-6  |
| 10 | 350 mm | 10 | 3809-350-38-2.00-10 |
| 10 | 400 mm | 10 | 3809-400-25-1.25-10 |
| 4  | 400 mm | 10 | 3809-400-32-1.60-4  |
| 6  | 400 mm | 10 | 3809-400-32-1.60-6  |
| 8  | 400 mm | 10 | 3809-400-32-1.60-8  |
| 10 | 400 mm | 10 | 3809-400-32-1.60-10 |
| 14 | 400 mm | 10 | 3809-400-32-1.60-14 |
| 4  | 400 mm | 10 | 3809-400-32-2.00-4  |
| 6  | 400 mm | 10 | 3809-400-32-2.00-6  |
| 8  | 400 mm | 10 | 3809-400-32-2.00-8  |
| 10 | 400 mm | 10 | 3809-400-32-2.00-10 |
| 4  | 400 mm | 10 | 3809-400-38-2.00-4  |
| 6  | 400 mm | 10 | 3809-400-38-2.00-6  |
| 10 | 400 mm | 10 | 3809-400-38-2.00-10 |
| 6  | 425 mm | 10 | 3809-425-32-1.60-6  |
| 10 | 425 mm | 10 | 3809-425-32-1.60-10 |
| 4  | 450 mm | 10 | 3809-450-32-1.60-4  |
| 6  | 450 mm | 10 | 3809-450-32-1.60-6  |
| 10 | 450 mm | 10 | 3809-450-32-1.60-10 |
| 14 | 450 mm | 10 | 3809-450-32-1.60-14 |
| 4  | 450 mm | 10 | 3809-450-32-2.00-4  |
| 6  | 450 mm | 10 | 3809-450-32-2.00-6  |
| 10 | 450 mm | 10 | 3809-450-32-2.00-10 |
| 4  | 450 mm | 10 | 3809-450-38-2.00-4  |
| 6  | 450 mm | 10 | 3809-450-38-2.00-6  |
| 8  | 450 mm | 10 | 3809-450-38-2.00-8  |
| 10 | 450 mm | 10 | 3809-450-38-2.00-10 |
| 4  | 450 mm | 10 | 3809-450-45-2.25-4  |
| 6  | 450 mm | 10 | 3809-450-45-2.25-6  |
| 6  | 475 mm | 10 | 3809-475-45-2.25-6  |
| 4  | 500 mm | 10 | 3809-500-38-2.00-4  |
| 6  | 500 mm | 10 | 3809-500-38-2.00-6  |
| 10 | 500 mm | 10 | 3809-500-38-2.00-10 |
| 4  | 500 mm | 10 | 3809-500-45-2.25-4  |
| 6  | 500 mm | 10 | 3809-500-45-2.25-6  |
| 4  | 500 mm | 10 | 3809-500-50-2.50-4  |
| 6  | 500 mm | 10 | 3809-500-50-2.50-6  |
| 8  | 500 mm | 10 | 3809-500-50-2.50-8  |
| 6  | 525 mm | 10 | 3809-525-38-2.00-6  |
| 10 | 525 mm | 10 | 3809-525-38-2.00-10 |
| 4  | 525 mm | 10 | 3809-525-45-2.25-4  |
| 6  | 525 mm | 10 | 3809-525-45-2.25-6  |
| 4  | 550 mm | 10 | 3809-550-45-2.25-4  |
| 6  | 550 mm | 10 | 3809-550-45-2.25-6  |
| 4  | 550 mm | 10 | 3809-550-50-2.50-4  |
| 6  | 550 mm | 10 | 3809-550-50-2.50-6  |
| 4  | 575 mm | 10 | 3809-575-45-2.25-4  |
| 3  | 575 mm | 10 | 3809-575-50-2.50-3  |
| 4  | 575 mm | 10 | 3809-575-50-2.50-4  |
| 6  | 575 mm | 10 | 3809-575-50-2.50-6  |
| 6  | 600 mm | 10 | 3809-600-38-2.00-6  |
| 4  | 600 mm | 10 | 3809-600-45-2.25-4  |
| 6  | 600 mm | 10 | 3809-600-45-2.25-6  |
| 3  | 600 mm | 10 | 3809-600-50-2.50-3  |
| 4  | 600 mm | 10 | 3809-600-50-2.50-4  |
| 6  | 600 mm | 10 | 3809-600-50-2.50-6  |
| 4  | 650 mm | 5  | 3809-650-50-2.50-4  |
| 6  | 650 mm | 5  | 3809-650-50-2.50-6  |
| 4  | 700 mm | 5  | 3809-700-50-2.50-4  |
| 6  | 700 mm | 5  | 3809-700-50-2.50-6  |
| 4  | 750 mm | 5  | 3809-750-50-2.50-4  |
| 6  | 750 mm | 5  | 3809-750-50-2.50-6  |

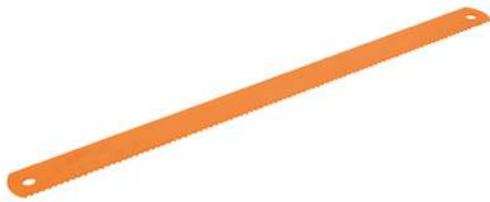

Sandflex® Bi-metal Power Hacksaw Blades for KASTO machines







**3809 KA**

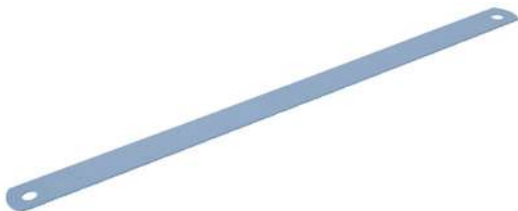



|  |  |  |  |
|--|---|---|---|
| 6  | 400 mm  | 10  | 3809-400-32-2.00-6-KA   |
| 4  | 450 mm  | 10  | 3809-450-38-2.00-4-KA   |
| 6  | 450 mm  | 10  | 3809-450-38-2.00-6-KA   |
| 10   | 450 mm  | 10  | 3809-450-38-2.00-10-KA  |
| 6  | 500 mm  | 10  | 3809-500-45-2.25-6-KA   |
| 4  | 500 mm  | 10  | 3809-500-50-2.50-4-KA   |
| 6  | 500 mm  | 10  | 3809-500-50-2.50-6-KA   |
| 4  | 550 mm  | 10  | 3809-550-50-2.50-4-KA   |
| 6  | 550 mm  | 10  | 3809-550-50-2.50-6-KA   |
| 3  | 575 mm  | 10  | 3809-575-50-2.50-3-KA   |
| 4  | 575 mm  | 10  | 3809-575-50-2.50-4-KA   |
| 6  | 575 mm  | 10  | 3809-575-50-2.50-6-KA   |
| 10   | 575 mm  | 10  | 3809-575-50-2.50-10-KA  |
| 4  | 600 mm  | 10  | 3809-600-50-2.50-4-KA   |
| 6  | 600 mm  | 10  | 3809-600-50-2.50-6-KA   |
| 3  | 650 mm  | 5   | 3809-650-50-2.50-3-KA   |
| 4  | 650 mm  | 5   | 3809-650-50-2.50-4-KA   |
| 6  | 650 mm  | 5   | 3809-650-50-2.50-6-KA   |
| 3  | 700 mm  | 5   | 3809-700-50-2.50-3-KA   |
| 4  | 700 mm  | 5   | 3809-700-50-2.50-4-KA   |
| 6  | 700 mm  | 5   | 3809-700-50-2.50-6-KA   |

HSS Power Hacksaw Blades



**3802**



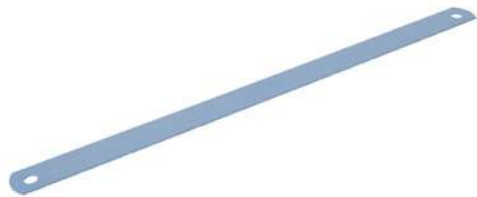

|  |  |  |  |
|--|---|---|---|
| 6  | 300 mm  | 10  | 3802-300-25-1.25-6  |
| 10   | 300 mm  | 10  | 3802-300-25-1.25-10   |
| 14   | 300 mm  | 10  | 3802-300-25-1.25-14   |
| 6  | 300 mm  | 10  | 3802-300-32-1.60-6  |
| 10   | 300 mm  | 10  | 3802-300-32-1.60-10   |
| 6  | 350 mm  | 10  | 3802-350-25-1.25-6  |
| 10   | 350 mm  | 10  | 3802-350-25-1.25-10   |
| 14   | 350 mm  | 10  | 3802-350-25-1.25-14   |
| 4  | 350 mm  | 10  | 3802-350-32-1.60-4  |
| 6  | 350 mm  | 10  | 3802-350-32-1.60-6  |
| 8  | 350 mm  | 10  | 3802-350-32-1.60-8  |
| 10   | 350 mm  | 10  | 3802-350-32-1.60-10   |
| 14   | 350 mm  | 10  | 3802-350-32-1.60-14   |
| 6  | 400 mm  | 10  | 3802-400-25-1.25-6  |
| 10   | 400 mm  | 10  | 3802-400-25-1.25-10   |
| 14   | 400 mm  | 10  | 3802-400-25-1.25-14   |
| 4  | 400 mm  | 10  | 3802-400-32-1.60-4  |
| 6  | 400 mm  | 10  | 3802-400-32-1.60-6  |
| 8  | 400 mm  | 10  | 3802-400-32-1.60-8  |
| 10   | 400 mm  | 10  | 3802-400-32-1.60-10   |
| 14   | 400 mm  | 10  | 3802-400-32-1.60-14   |
| 4  | 400 mm  | 10  | 3802-400-38-2.00-4  |

|  |  |  |  |
|---|---|---|---|
| 6   | 400 mm  | 10  | 3802-400-38-2.00-6  |
| 10  | 400 mm  | 10  | 3802-400-38-2.00-10   |
| 6   | 425 mm  | 10  | 3802-425-32-1.60-6  |
| 10  | 425 mm  | 10  | 3802-425-32-1.60-10   |
| 4   | 450 mm  | 10  | 3802-450-32-1.60-4  |
| 6   | 450 mm  | 10  | 3802-450-32-1.60-6  |
| 10  | 450 mm  | 10  | 3802-450-32-1.60-10   |
| 14  | 450 mm  | 10  | 3802-450-32-1.60-14   |
| 4   | 450 mm  | 10  | 3802-450-38-2.00-4  |
| 6   | 450 mm  | 10  | 3802-450-38-2.00-6  |
| 8   | 450 mm  | 10  | 3802-450-38-2.00-8  |
| 10  | 450 mm  | 10  | 3802-450-38-2.00-10   |
| 8   | 475 mm  | 10  | 3802-475-38-2.00-8  |
| 4   | 500 mm  | 10  | 3802-500-38-2.00-4  |
| 6   | 500 mm  | 10  | 3802-500-38-2.00-6  |
| 8   | 500 mm  | 10  | 3802-500-38-2.00-8  |
| 10  | 500 mm  | 10  | 3802-500-38-2.00-10   |
| 10  | 500 mm  | 10  | 3802-500-45-2.25-10   |
| 4   | 500 mm  | 10  | 3802-500-50-2.50-4  |
| 6   | 500 mm  | 10  | 3802-500-50-2.50-6  |
| 6   | 525 mm  | 10  | 3802-525-38-2.00-6  |
| 8   | 525 mm  | 10  | 3802-525-38-2.00-8  |
| 10  | 525 mm  | 10  | 3802-525-38-2.00-10   |
| 6   | 550 mm  | 10  | 3802-550-38-2.00-6  |
| 4   | 550 mm  | 10  | 3802-550-50-2.50-4  |
| 6   | 550 mm  | 10  | 3802-550-50-2.50-6  |
| 8   | 550 mm  | 5   | 3802-550-50-2.50-8  |
| 10  | 550 mm  | 10  | 3802-550-50-2.50-10   |
| 4   | 575 mm  | 10  | 3802-575-50-2.50-4  |
| 6   | 575 mm  | 10  | 3802-575-50-2.50-6  |
| 4   | 600 mm  | 10  | 3802-600-50-2.50-4  |
| 6   | 600 mm  | 10  | 3802-600-50-2.50-6  |
| 8   | 600 mm  | 10  | 3802-600-50-2.50-8  |
| 4   | 650 mm  | 5   | 3802-650-50-2.50-4  |
| 6   | 650 mm  | 5   | 3802-650-50-2.50-6  |
| 3   | 700 mm  | 5   | 3802-700-50-2.50-3  |
| 4   | 700 mm  | 5   | 3802-700-50-2.50-4  |
| 6   | 700 mm  | 5   | 3802-700-50-2.50-6  |
| 4   | 750 mm  | 5   | 3802-750-50-2.50-4  |
| 6   | 750 mm  | 5   | 3802-750-50-2.50-6  |

HSS Power Hacksaw Blades for KASTO machines



**3802 KA**

|  |  |  |  |
|---|---|---|---|
| 4   | 450 mm  | 10  | 3802-450-38-2.00-4-KA   |
| 6   | 450 mm  | 10  | 3802-450-38-2.00-6-KA   |
| 8   | 450 mm  | 10  | 3802-450-38-2.00-8-KA   |
| 10  | 450 mm  | 10  | 3802-450-38-2.00-10-KA  |
| 4   | 500 mm  | 10  | 3802-500-50-2.50-4-KA   |
| 6   | 500 mm  | 10  | 3802-500-50-2.50-6-KA   |
| 4   | 550 mm  | 10  | 3802-550-50-2.50-4-KA   |
| 8   | 550 mm  | 10  | 3802-550-50-2.50-8-KA   |
| 3   | 575 mm  | 10  | 3802-575-50-2.50-3-KA   |
| 4   | 575 mm  | 10  | 3802-575-50-2.50-4-KA   |
| 6   | 575 mm  | 10  | 3802-575-50-2.50-6-KA   |
| 4   | 650 mm  | 5   | 3802-650-50-2.50-4-KA   |
| 6   | 650 mm  | 5   | 3802-650-50-2.50-6-KA   |
| 2   | 700 mm  | 5   | 3802-700-50-2.50-2-KA   |
| 4   | 700 mm  | 5   | 3802-700-50-2.50-4-KA   |
| 6   | 700 mm  | 5   | 3802-700-50-2.50-6-KA   |



## BANDSAW ACCESSORIES

Chip Brushes for Cleaning Bandsaw Blade



### 3870-BRUSH



|        |   |                       |
|--------|---|-----------------------|
| 60 mm  | 4 | 3870-BRUSH-60-6       |
| 80 mm  | 4 | 3870-BRUSH-80-6       |
| 80 mm  | 4 | 3870-BRUSH-80-8       |
| 80 mm  | 4 | 3870-BRUSH-80-10      |
| 100 mm | 4 | 3870-BRUSH-100-10     |
| 100 mm | 4 | 3870-BRUSH-100-12     |
| 100 mm | 4 | 3870-BRUSH-100-10-HEX |
| 100 mm | 1 | 3870-BRUSH-100-13     |

Tachometers for Bandsaw



### 3870-TACHO



|       |   |                  |
|-------|---|------------------|
| 400 g | 1 | 3870-TACHO METER |
|-------|---|------------------|

Tension Meters for Bandsaw



### 3870-TENSION



|       |   |                    |
|-------|---|--------------------|
| 680 g | 1 | 3870-TENSION METER |
|-------|---|--------------------|

Refractometers for Bandsaw



### 3870-REFR



|       |   |                    |
|-------|---|--------------------|
| 260 g | 1 | 3870-REFRACTOMETER |
|-------|---|--------------------|

Steel Wedges 75 mm



### 3870-WEDGE



|      |   |              |
|------|---|--------------|
| 60 g | 1 | 3870-WEDGE-3 |
|------|---|--------------|

Bandsaw Tension Adjusting Wheel



### 3870-Wheel



|           |   |            |
|-----------|---|------------|
| 0.7790 kg | 1 | 3870-WHEEL |
|-----------|---|------------|



# Files



## ENGINEERING FILES

Engineering Flat Hand Files Bastard/  
Second/Smooth Cut Unhandled



### 1-100...-0

| Length | Cut | Quantity | Part No.     |
|--------|-----|----------|--------------|
| 100 mm | 1   | 10       | 1-100-04-1-0 |
| 100 mm | 2   | 10       | 1-100-04-2-0 |
| 100 mm | 3   | 10       | 1-100-04-3-0 |
| 150 mm | 1   | 10       | 1-100-06-1-0 |
| 150 mm | 2   | 10       | 1-100-06-2-0 |
| 150 mm | 3   | 10       | 1-100-06-3-0 |
| 200 mm | 1   | 10       | 1-100-08-1-0 |
| 200 mm | 2   | 10       | 1-100-08-2-0 |
| 200 mm | 3   | 10       | 1-100-08-3-0 |
| 250 mm | 1   | 10       | 1-100-10-1-0 |
| 250 mm | 2   | 10       | 1-100-10-2-0 |
| 250 mm | 3   | 10       | 1-100-10-3-0 |
| 300 mm | 1   | 5        | 1-100-12-1-0 |
| 300 mm | 2   | 5        | 1-100-12-2-0 |
| 300 mm | 3   | 5        | 1-100-12-3-0 |
| 350 mm | 1   | 5        | 1-100-14-1-0 |
| 350 mm | 2   | 5        | 1-100-14-2-0 |

Type of cut: 1 = Bastard, 2 = Second, 3 = Smooth

ERGO™ Engineering Flat Hand Files  
Bastard/Second/Smooth Cut



ergo



### 1-100...-2

| Length | Cut | Quantity | Part No.     |
|--------|-----|----------|--------------|
| 100 mm | 1   | 5        | 1-100-04-1-2 |
| 100 mm | 2   | 5        | 1-100-04-2-2 |
| 150 mm | 1   | 5        | 1-100-06-1-2 |
| 150 mm | 2   | 5        | 1-100-06-2-2 |
| 150 mm | 3   | 5        | 1-100-06-3-2 |
| 200 mm | 1   | 5        | 1-100-08-1-2 |
| 200 mm | 2   | 5        | 1-100-08-2-2 |
| 200 mm | 3   | 5        | 1-100-08-3-2 |
| 250 mm | 1   | 5        | 1-100-10-1-2 |
| 250 mm | 2   | 5        | 1-100-10-2-2 |
| 250 mm | 3   | 5        | 1-100-10-3-2 |
| 300 mm | 1   | 5        | 1-100-12-1-2 |
| 300 mm | 2   | 5        | 1-100-12-2-2 |
| 300 mm | 3   | 5        | 1-100-12-3-2 |

Type of cut: 1 = Bastard, 2 = Second, 3 = Smooth

Engineering Pillar Files Bastard/Second/  
Smooth Cut Unhandled



### 1-102

| Length | Cut | Quantity | Part No.     |
|--------|-----|----------|--------------|
| 150 mm | 2   | 10       | 1-102-06-2-0 |
| 150 mm | 3   | 10       | 1-102-06-3-0 |
| 200 mm | 1   | 10       | 1-102-08-1-0 |
| 200 mm | 2   | 10       | 1-102-08-2-0 |
| 200 mm | 3   | 10       | 1-102-08-3-0 |

Type of cut: 1 = Bastard, 2 = Second, 3 = Smooth

Engineering Lathe Files Second/Smooth  
Cut Unhandled



### 1-104

| Length | Cut | Quantity | Part No.     |
|--------|-----|----------|--------------|
| 250 mm | 2   | 10       | 1-104-10-2-0 |
| 250 mm | 3   | 10       | 1-104-10-3-0 |
| 300 mm | 2   | 5        | 1-104-12-2-0 |
| 300 mm | 3   | 5        | 1-104-12-3-0 |
| 350 mm | 3   | 5        | 1-104-14-3-0 |

Type of cut: 1 = Bastard, 2 = Second, 3 = Smooth

Engineering Oberg Cut Flat Hand Files  
Bastard Cut Unhandled



### 1-106...-0

| Length | Cut | Quantity | Part No.     |
|--------|-----|----------|--------------|
| 200 mm | 1   | 10       | 1-106-08-1-0 |
| 250 mm | 1   | 10       | 1-106-10-1-0 |
| 300 mm | 1   | 5        | 1-106-12-1-0 |

Type of cut: 1 = Bastard, 2 = Second, 3 = Smooth

ERGO™ Engineering Oberg Cut Flat Hand  
Files Bastard Cut



ergo



### 1-106...-2

| Length | Cut | Quantity | Part No.     |
|--------|-----|----------|--------------|
| 200 mm | 1   | 5        | 1-106-08-1-2 |
| 250 mm | 1   | 5        | 1-106-10-1-2 |
| 300 mm | 1   | 5        | 1-106-12-1-2 |

Type of cut: 1 = Bastard, 2 = Second, 3 = Smooth

Engineering Flat Files with Tapered Edge  
Bastard/Second/Smooth Cut Unhandled



### 1-110...-0

| Length | Cut | Quantity | Part No.     |
|--------|-----|----------|--------------|
| 100 mm | 1   | 10       | 1-110-04-1-0 |
| 100 mm | 2   | 10       | 1-110-04-2-0 |
| 100 mm | 2   | 10       | 1-110-04-3-0 |
| 150 mm | 1   | 10       | 1-110-06-1-0 |
| 150 mm | 2   | 10       | 1-110-06-2-0 |
| 150 mm | 3   | 10       | 1-110-06-3-0 |
| 200 mm | 1   | 10       | 1-110-08-1-0 |
| 200 mm | 2   | 10       | 1-110-08-2-0 |
| 200 mm | 2   | 10       | 1-110-08-3-0 |
| 250 mm | 1   | 10       | 1-110-10-1-0 |
| 250 mm | 2   | 10       | 1-110-10-2-0 |
| 250 mm | 3   | 10       | 1-110-10-3-0 |
| 300 mm | 1   | 5        | 1-110-12-1-0 |
| 300 mm | 2   | 5        | 1-110-12-2-0 |
| 300 mm | 3   | 5        | 1-110-12-3-0 |
| 350 mm | 1   | 5        | 1-110-14-1-0 |

Type of cut: 1 = Bastard, 2 = Second, 3 = Smooth

ERGO™ Engineering Tapered Edge Flat File Bastard/Second/Smooth Cut



**1-110...-2**



|        |   |   |              |
|--------|---|---|--------------|
| 150 mm | 1 | 5 | 1-110-06-1-2 |
| 150 mm | 2 | 5 | 1-110-06-2-2 |
| 150 mm | 3 | 5 | 1-110-06-3-2 |
| 200 mm | 1 | 5 | 1-110-08-1-2 |
| 200 mm | 2 | 5 | 1-110-08-2-2 |
| 200 mm | 3 | 5 | 1-110-08-3-2 |
| 250 mm | 1 | 5 | 1-110-10-1-2 |
| 250 mm | 2 | 5 | 1-110-10-2-2 |
| 250 mm | 3 | 5 | 1-110-10-3-2 |
| 300 mm | 1 | 5 | 1-110-12-1-2 |
| 300 mm | 2 | 5 | 1-110-12-2-2 |
| 300 mm | 3 | 5 | 1-110-12-3-2 |

Type of cut: 1 = Bastard, 2 = Second, 3 = Smooth

Engineering Warding Flat Hand Files Bastard/Second/Smooth Cut Unhandled



**1-111...-0**



|        |   |    |              |
|--------|---|----|--------------|
| 100 mm | 1 | 10 | 1-111-04-1-0 |
| 100 mm | 2 | 10 | 1-111-04-2-0 |
| 100 mm | 3 | 10 | 1-111-04-3-0 |
| 150 mm | 1 | 10 | 1-111-06-1-0 |
| 150 mm | 2 | 10 | 1-111-06-2-0 |
| 150 mm | 3 | 10 | 1-111-06-3-0 |
| 200 mm | 1 | 10 | 1-111-08-1-0 |
| 200 mm | 2 | 10 | 1-111-08-2-0 |

Type of cut: 1 = Bastard, 2 = Second, 3 = Smooth

ERGO™ Engineering Warding Flat Files Second Cut



**1-111...-2**



|        |   |   |              |
|--------|---|---|--------------|
| 150 mm | 2 | 5 | 1-111-06-2-2 |
|--------|---|---|--------------|

Type of cut: 1 = Bastard, 2 = Second, 3 = Smooth

Engineering Flat Contact Files Smooth Cut Unhandled



**1-115**



|        |   |    |              |
|--------|---|----|--------------|
| 110 mm | 3 | 10 | 1-115-11-3-1 |
|--------|---|----|--------------|

Engineering Mill Files with 2 Flat Edges Bastard/Second Cut Unhandled



**1-143...-0**



|        |   |    |              |
|--------|---|----|--------------|
| 100 mm | 1 | 10 | 1-143-04-1-0 |
| 150 mm | 1 | 10 | 1-143-06-1-0 |
| 200 mm | 1 | 10 | 1-143-08-1-0 |
| 250 mm | 1 | 10 | 1-143-10-1-0 |
| 300 mm | 1 | 5  | 1-143-12-1-0 |

Type of cut: 1 = Bastard, 2 = Second, 3 = Smooth

ERGO™ Engineering Mill Files with 2 Flat Edges Bastard/Second Cut



**1-143...-2**



|        |   |   |              |
|--------|---|---|--------------|
| 150 mm | 1 | 5 | 1-143-06-1-2 |
| 200 mm | 1 | 5 | 1-143-08-1-2 |
| 250 mm | 1 | 5 | 1-143-10-1-2 |
| 300 mm | 1 | 5 | 1-143-12-1-2 |

Type of cut: 1 = Bastard, 2 = Second, 3 = Smooth

ERGO™ Engineering Diagonal Files Second Cut



**1-320 ...-2**



|        |   |   |              |
|--------|---|---|--------------|
| 200 mm | 2 | 5 | 1-320-08-2-2 |
| 250 mm | 2 | 5 | 1-320-10-2-2 |

Type of cut: 1 = Bastard, 2 = Second, 3 = Smooth

Engineering Diagonal Files Second Cut Unhandled



**1-320...-0**



|        |   |    |              |
|--------|---|----|--------------|
| 200 mm | 2 | 10 | 1-320-08-2-0 |
| 250 mm | 2 | 10 | 1-320-10-2-0 |
| 300 mm | 2 | 5  | 1-320-12-2-0 |

Type of cut: 1 = Bastard, 2 = Second, 3 = Smooth



Engineering Half-Round Files Bastard/  
Second/Smooth Cut Unhandled



**1-210...-0**

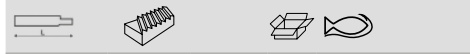

|        |   |    |              |
|--------|---|----|--------------|
| 100 mm | 1 | 10 | 1-210-04-1-0 |
| 100 mm | 2 | 10 | 1-210-04-2-0 |
| 100 mm | 3 | 10 | 1-210-04-3-0 |
| 150 mm | 1 | 10 | 1-210-06-1-0 |
| 150 mm | 2 | 10 | 1-210-06-2-0 |
| 150 mm | 3 | 10 | 1-210-06-3-0 |
| 200 mm | 1 | 10 | 1-210-08-1-0 |
| 200 mm | 2 | 10 | 1-210-08-2-0 |
| 200 mm | 3 | 10 | 1-210-08-3-0 |
| 250 mm | 1 | 10 | 1-210-10-1-0 |
| 250 mm | 2 | 10 | 1-210-10-2-0 |
| 250 mm | 3 | 10 | 1-210-10-3-0 |
| 300 mm | 1 | 5  | 1-210-12-1-0 |
| 300 mm | 2 | 5  | 1-210-12-2-0 |
| 300 mm | 3 | 5  | 1-210-12-3-0 |
| 350 mm | 1 | 5  | 1-210-14-1-0 |

Type of cut: 1 = Bastard, 2 = Second, 3 = Smooth

Engineering Round Files Bastard/Second/  
Smooth Cut Unhandled



**1-230...-0**

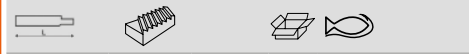

|        |   |    |              |
|--------|---|----|--------------|
| 100 mm | 1 | 10 | 1-230-04-1-0 |
| 100 mm | 2 | 10 | 1-230-04-2-0 |
| 100 mm | 3 | 10 | 1-230-04-3-0 |
| 150 mm | 1 | 10 | 1-230-06-1-0 |
| 150 mm | 2 | 10 | 1-230-06-2-0 |
| 150 mm | 3 | 10 | 1-230-06-3-0 |
| 200 mm | 1 | 10 | 1-230-08-1-0 |
| 200 mm | 2 | 10 | 1-230-08-2-0 |
| 200 mm | 3 | 10 | 1-230-08-3-0 |
| 250 mm | 1 | 10 | 1-230-10-1-0 |
| 250 mm | 2 | 10 | 1-230-10-2-0 |
| 250 mm | 3 | 10 | 1-230-10-3-0 |
| 300 mm | 1 | 5  | 1-230-12-1-0 |
| 300 mm | 2 | 5  | 1-230-12-2-0 |
| 300 mm | 3 | 5  | 1-230-12-3-0 |

Type of cut: 1 = Bastard, 2 = Second, 3 = Smooth

Engineering Three Square Files Bastard/  
Second/Smooth Cut Unhandled



**1-170...-0**

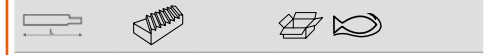

|        |   |    |              |
|--------|---|----|--------------|
| 100 mm | 1 | 10 | 1-170-04-1-0 |
| 100 mm | 2 | 10 | 1-170-04-2-0 |
| 100 mm | 3 | 10 | 1-170-04-3-0 |
| 150 mm | 1 | 10 | 1-170-06-1-0 |
| 150 mm | 2 | 10 | 1-170-06-2-0 |
| 150 mm | 3 | 10 | 1-170-06-3-0 |
| 200 mm | 1 | 10 | 1-170-08-1-0 |
| 200 mm | 2 | 10 | 1-170-08-2-0 |
| 200 mm | 3 | 10 | 1-170-08-3-0 |
| 250 mm | 1 | 10 | 1-170-10-1-0 |
| 250 mm | 2 | 10 | 1-170-10-2-0 |
| 250 mm | 3 | 10 | 1-170-10-3-0 |
| 300 mm | 1 | 5  | 1-170-12-1-0 |
| 300 mm | 2 | 5  | 1-170-12-2-0 |

Type of cut: 1 = Bastard, 2 = Second, 3 = Smooth

ERGO™ Engineering Half-Round Files  
Bastard/Second/Smooth Cut



ergo



**1-210...-2**



|        |   |   |              |
|--------|---|---|--------------|
| 100 mm | 1 | 5 | 1-210-04-1-2 |
| 100 mm | 2 | 5 | 1-210-04-2-2 |
| 150 mm | 1 | 5 | 1-210-06-1-2 |
| 150 mm | 2 | 5 | 1-210-06-2-2 |
| 150 mm | 3 | 5 | 1-210-06-3-2 |
| 200 mm | 1 | 5 | 1-210-08-1-2 |
| 200 mm | 2 | 5 | 1-210-08-2-2 |
| 200 mm | 3 | 5 | 1-210-08-3-2 |
| 250 mm | 1 | 5 | 1-210-10-1-2 |
| 250 mm | 2 | 5 | 1-210-10-2-2 |
| 250 mm | 3 | 5 | 1-210-10-3-2 |
| 300 mm | 1 | 5 | 1-210-12-1-2 |
| 300 mm | 2 | 5 | 1-210-12-2-2 |
| 300 mm | 3 | 5 | 1-210-12-3-2 |

Type of cut: 1 = Bastard, 2 = Second, 3 = Smooth

ERGO™ Engineering Round Files  
Bastard/Second/Smooth Cut



ergo



**1-230...-2**



|        |   |   |              |
|--------|---|---|--------------|
| 100 mm | 1 | 5 | 1-230-04-1-2 |
| 100 mm | 2 | 5 | 1-230-04-2-2 |
| 150 mm | 1 | 5 | 1-230-06-1-2 |
| 150 mm | 2 | 5 | 1-230-06-2-2 |
| 150 mm | 3 | 5 | 1-230-06-3-2 |
| 200 mm | 1 | 5 | 1-230-08-1-2 |
| 200 mm | 2 | 5 | 1-230-08-2-2 |
| 200 mm | 3 | 5 | 1-230-08-3-2 |
| 250 mm | 1 | 5 | 1-230-10-1-2 |
| 250 mm | 2 | 5 | 1-230-10-2-2 |
| 250 mm | 3 | 5 | 1-230-10-3-2 |
| 300 mm | 1 | 5 | 1-230-12-1-2 |
| 300 mm | 2 | 5 | 1-230-12-2-2 |
| 300 mm | 3 | 5 | 1-230-12-3-2 |

Type of cut: 1 = Bastard, 2 = Second, 3 = Smooth

ERGO™ Engineering Three Square Files  
Bastard/Second/Smooth Cut



ergo



**1-170...-2**



|        |   |   |              |
|--------|---|---|--------------|
| 100 mm | 2 | 5 | 1-170-04-2-2 |
| 150 mm | 1 | 5 | 1-170-06-1-2 |
| 150 mm | 2 | 5 | 1-170-06-2-2 |
| 150 mm | 3 | 5 | 1-170-06-3-2 |
| 200 mm | 1 | 5 | 1-170-08-1-2 |
| 200 mm | 2 | 5 | 1-170-08-2-2 |
| 200 mm | 3 | 5 | 1-170-08-3-2 |
| 250 mm | 1 | 5 | 1-170-10-1-2 |
| 250 mm | 2 | 5 | 1-170-10-2-2 |
| 250 mm | 3 | 5 | 1-170-10-3-2 |

Type of cut: 1 = Bastard, 2 = Second, 3 = Smooth



Engineering Square Files Bastard/Second/  
Smooth Cut Unhandled



**1-160...-0**

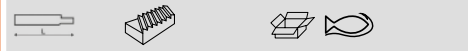

|        |   |    |              |
|--------|---|----|--------------|
| 100 mm | 1 | 10 | 1-160-04-1-0 |
| 100 mm | 2 | 10 | 1-160-04-2-0 |
| 100 mm | 3 | 10 | 1-160-04-3-0 |
| 150 mm | 1 | 10 | 1-160-06-1-0 |
| 150 mm | 2 | 10 | 1-160-06-2-0 |
| 150 mm | 3 | 10 | 1-160-06-3-0 |
| 200 mm | 1 | 10 | 1-160-08-1-0 |
| 200 mm | 2 | 10 | 1-160-08-2-0 |
| 200 mm | 3 | 10 | 1-160-08-3-0 |
| 250 mm | 1 | 10 | 1-160-10-1-0 |
| 250 mm | 2 | 10 | 1-160-10-2-0 |
| 250 mm | 3 | 10 | 1-160-10-3-0 |
| 300 mm | 1 | 5  | 1-160-12-1-0 |
| 300 mm | 2 | 5  | 1-160-12-2-0 |
| 300 mm | 3 | 5  | 1-160-12-3-0 |

Type of cut: 1 = Bastard, 2 = Second, 3 = Smooth

ERGO™ Engineering Square Files  
Bastard/Second/Smooth Cut



**1-160...-2**

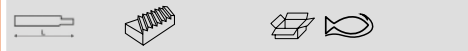

|        |   |   |              |
|--------|---|---|--------------|
| 100 mm | 1 | 5 | 1-160-04-1-2 |
| 100 mm | 2 | 5 | 1-160-04-2-2 |
| 150 mm | 1 | 5 | 1-160-06-1-2 |
| 150 mm | 2 | 5 | 1-160-06-2-2 |
| 150 mm | 3 | 5 | 1-160-06-3-2 |
| 200 mm | 1 | 5 | 1-160-08-1-2 |
| 200 mm | 2 | 5 | 1-160-08-2-2 |
| 200 mm | 3 | 5 | 1-160-08-3-2 |
| 250 mm | 1 | 5 | 1-160-10-1-2 |
| 250 mm | 2 | 5 | 1-160-10-2-2 |
| 250 mm | 3 | 5 | 1-160-10-3-2 |
| 300 mm | 1 | 5 | 1-160-12-1-2 |
| 300 mm | 2 | 5 | 1-160-12-2-2 |
| 300 mm | 3 | 5 | 1-160-12-3-2 |

Type of cut: 1 = Bastard, 2 = Second, 3 = Smooth

ERGO™ Engineering File Set Smooth  
Cut - 6 Pcs



**1-476**

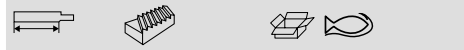

|        |   |   |              |
|--------|---|---|--------------|
| 100 mm | 3 | 1 | 1-476-04-3-2 |
|--------|---|---|--------------|

1-160-04-3-2, 1-111-04-3-2, 1-230-04-3-2, 1-170-04-3-2, 1-210-04-3-2, 1-100-04-3-2

ERGO™ Engineering File Set Second Cut  
150 mm - 3 Pcs



**1-473**



|        |   |   |              |
|--------|---|---|--------------|
| 150 mm | 2 | 5 | 1-473-06-2-2 |
|--------|---|---|--------------|

1-230-06-2-2

1-210-06-2-2

1-100-06-2-2

ERGO™ Engineering File Set Second Cut  
200 mm - 3 Pcs



**1-473-08-2-2**



|        |   |   |              |
|--------|---|---|--------------|
| 200 mm | 2 | 5 | 1-473-08-2-2 |
|--------|---|---|--------------|

1-230-08-2-2

1-210-08-2-2

1-100-08-2-2

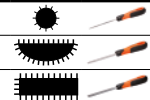

ERGO™ Engineering File Set Second Cut  
250 mm - 3 Pcs



**1-473-10-2-2\_1**

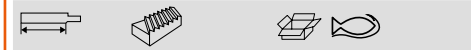

|        |   |   |              |
|--------|---|---|--------------|
| 250 mm | 2 | 5 | 1-473-10-2-2 |
|--------|---|---|--------------|

1-230-10-2-2

1-210-10-2-2

1-100-10-2-2

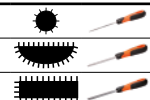

ERGO™ Engineering File Set with Half-  
Round Rasp Second Cut 200 mm - 5 Pcs



**1-477**

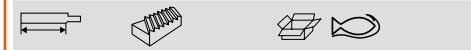

|        |   |   |              |
|--------|---|---|--------------|
| 200 mm | 2 | 5 | 1-477-08-2-2 |
|--------|---|---|--------------|

1-100-08-2-2

1-210-08-2-2

6-343-08-2-2

1-230-08-2-2

1-170-08-2-2

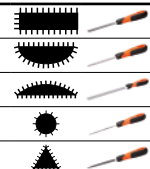

ERGO™ Engineering File Set with Half-Round Rasp Second Cut 250 mm - 5 Pcs



ergo



**1-477-10-2-2**

|        |   |   |              |
|--------|---|---|--------------|
|        |   |   |              |
| 250 mm | 2 | 5 | 1-477-10-2-2 |

|              |  |  |  |  |
|--------------|--|--|--|--|
| 1-100-10-2-2 |  |  |  |  |
| 1-210-10-2-2 |  |  |  |  |
| 6-343-10-2-2 |  |  |  |  |
| 1-230-10-2-2 |  |  |  |  |
| 1-170-10-2-2 |  |  |  |  |

ERGO™ Engineering File Set 4 Bastard/1 Second Cut 200 mm - 5 Pcs



ergo



**1-478**

|        |     |   |              |
|--------|-----|---|--------------|
|        |     |   |              |
| 200 mm | 1&2 | 5 | 1-478-08-1-2 |

|                            |  |  |  |  |
|----------------------------|--|--|--|--|
| 1-210-08-1-2               |  |  |  |  |
| 1-230-08-1-2               |  |  |  |  |
| 1-100-08-1-2, 1-100-08-2-2 |  |  |  |  |
| 1-160-08-1-2               |  |  |  |  |

ERGO™ Engineering File Set 4 Bastard/1 Second Cut 250 mm - 5 Pcs



ergo



**1-478-10-1-2\_1**

|        |     |   |              |
|--------|-----|---|--------------|
|        |     |   |              |
| 250 mm | 1&2 | 5 | 1-478-10-1-2 |

|                            |  |  |  |  |
|----------------------------|--|--|--|--|
| 1-210-10-1-2               |  |  |  |  |
| 1-230-10-1-2               |  |  |  |  |
| 1-100-10-1-2, 1-100-10-2-2 |  |  |  |  |
| 1-160-10-1-2               |  |  |  |  |

ERGO™ Engineering File Set with Cabinet Rasp Bastard Cut 200 mm - 5 Pcs



ergo



**1-479**

|        |   |   |              |
|--------|---|---|--------------|
|        |   |   |              |
| 200 mm | 1 | 5 | 1-479-08-1-2 |

|              |  |  |  |  |
|--------------|--|--|--|--|
| 4-138-08-1-2 |  |  |  |  |
| 1-210-08-1-2 |  |  |  |  |
| 6-343-08-2-2 |  |  |  |  |
| 1-230-08-1-2 |  |  |  |  |
| 1-100-08-1-2 |  |  |  |  |

ERGO™ Engineering File Set with Cabinet Rasp Second Cut 200 mm - 5 Pcs



ergo



**1-479-08-2-2**

|        |   |   |              |
|--------|---|---|--------------|
|        |   |   |              |
| 200 mm | 2 | 5 | 1-479-08-2-2 |

|              |  |  |  |  |
|--------------|--|--|--|--|
| 4-138-08-1-2 |  |  |  |  |
| 1-210-08-2-2 |  |  |  |  |
| 6-343-08-2-2 |  |  |  |  |
| 1-230-08-2-2 |  |  |  |  |
| 1-100-08-2-2 |  |  |  |  |

## SHARPENING FILES

ERGO™ Flat Chainsaw Files



ergo



**166-2**

|        |   |   |                |
|--------|---|---|----------------|
|        |   |   |                |
| 150 mm | 3 | 5 | 166-6-16-2.5-2 |

Flat Chainsaw Files Unhandled



**166/167-12**

|        |   |    |                 |
|--------|---|----|-----------------|
|        |   |    |                 |
| 150 mm | 3 | 12 | 166-6-16-2.5-12 |
| 200 mm | 1 | 12 | 167-8-21-3.2-12 |

Round Chainsaw Files - 12 x 1 Pck



**168 - 1P**

|        |        |    |              |
|--------|--------|----|--------------|
|        |        |    |              |
| 150 mm | 3.2 mm | 12 | 168-6-3.2-1P |
| 150 mm | 3.5 mm | 12 | 168-6-3.5-1P |
| 200 mm | 4.0 mm | 12 | 168-8-4.0-1P |
| 200 mm | 4.5 mm | 12 | 168-8-4.5-1P |
| 200 mm | 4.8 mm | 12 | 168-8-4.8-1P |
| 200 mm | 5.2 mm | 12 | 168-8-5.2-1P |
| 200 mm | 5.5 mm | 12 | 168-8-5.5-1P |
| 200 mm | 6.3 mm | 12 | 168-8-6.3-1P |

Round Chainsaw Files - 12 x 3 Pck



**168 - 3P**

| Length | Thickness | Quantity | Part No.     |
|--------|-----------|----------|--------------|
| 150 mm | 3.2 mm    | 12       | 168-6-3.2-3P |
| 150 mm | 3.5 mm    | 12       | 168-6-3.5-3P |
| 200 mm | 4.0 mm    | 12       | 168-8-4.0-3P |
| 200 mm | 4.5 mm    | 12       | 168-8-4.5-3P |
| 200 mm | 4.8 mm    | 12       | 168-8-4.8-3P |
| 200 mm | 5.2 mm    | 12       | 168-8-5.2-3P |
| 200 mm | 5.5 mm    | 12       | 168-8-5.5-3P |
| 200 mm | 6.3 mm    | 12       | 168-8-6.3-3P |

ERGO™ Chainsaw File Set with Two-Component Handle



**168-C**

| Length | Thickness | Quantity | Part No.      |
|--------|-----------|----------|---------------|
| 200 mm | 4.0 mm    | 10       | 168-COMBI-4.0 |
| 200 mm | 4.5 mm    | 10       | 168-COMBI-4.5 |
| 200 mm | 4.8 mm    | 10       | 168-COMBI-4.8 |
| 200 mm | 5.5 mm    | 10       | 168-COMBI-5.5 |

Mill Saw Files with 2 Round Edges Bastard Cut Unhandled



**4-140...-0**

| Length | Quantity | Quantity | Part No.     |
|--------|----------|----------|--------------|
| 150 mm | 1        | 10       | 4-140-06-1-0 |
| 200 mm | 1        | 10       | 4-140-08-1-0 |
| 250 mm | 1        | 10       | 4-140-10-1-0 |

Round Chainsaw Files - 6 Pck



**168-8**

| Length | Thickness | Quantity | Part No.    |
|--------|-----------|----------|-------------|
| 200 mm | 4.0 mm    | 6        | 168-8-4.0-6 |
| 200 mm | 4.5 mm    | 6        | 168-8-4.5-6 |
| 200 mm | 4.8 mm    | 6        | 168-8-4.8-6 |
| 200 mm | 5.2 mm    | 6        | 168-8-5.2-6 |
| 200 mm | 5.5 mm    | 6        | 168-8-5.5-6 |

Mill Saw Files with 1 Round Edge Bastard Cut Unhandled



**4-138...-0**

| Length | Quantity | Quantity | Part No.     |
|--------|----------|----------|--------------|
| 150 mm | 1        | 10       | 4-138-06-1-0 |
| 200 mm | 1        | 10       | 4-138-08-1-0 |
| 250 mm | 1        | 10       | 4-138-10-1-0 |
| 300 mm | 1        | 5        | 4-138-12-1-0 |

ERGO™ Mill Saw Files with Dual-Component Handle and 2 Round Edges Bastard Cut



**4-140...-2**

| Length | Quantity | Quantity | Part No.     |
|--------|----------|----------|--------------|
| 200 mm | 1        | 5        | 4-140-08-1-2 |
| 250 mm | 1        | 5        | 4-140-10-1-2 |

ERGO™ Chainsaw File Set with Two-Component Handle and Filing Guide



**168-C-G**

| Length | Thickness | Quantity | Part No.           |
|--------|-----------|----------|--------------------|
| 200 mm | 4.0 mm    | 10       | 168-COMBI-4.0-6922 |
| 200 mm | 4.8 mm    | 10       | 168-COMBI-4.8-6920 |
| 200 mm | 5.5 mm    | 10       | 168-COMBI-5.5-6924 |

ERGO™ Mill Saw Files with Dual-Component Handle and 1 Round Edge Bastard Cut



**4-138...-2**

| Length | Quantity | Quantity | Part No.     |
|--------|----------|----------|--------------|
| 150 mm | 1        | 5        | 4-138-06-1-2 |
| 200 mm | 1        | 5        | 4-138-08-1-2 |
| 250 mm | 1        | 5        | 4-138-10-1-2 |
| 300 mm | 1        | 5        | 4-138-12-1-2 |

Mill Saw Files with 2 Flat Edges Bastard Cut Unhandled



**4-142**

| Length | Quantity | Quantity | Part No.     |
|--------|----------|----------|--------------|
| 150 mm | 1        | 10       | 4-142-06-1-0 |
| 200 mm | 1        | 10       | 4-142-08-1-0 |
| 250 mm | 1        | 10       | 4-142-10-1-0 |



Mill Saw Files with 1 Round Edge Extra thin Second Cut Unhandled



**4-144...-0**

|        |   |    |              |
|--------|---|----|--------------|
|        |   |    |              |
| 200 mm | 2 | 10 | 4-144-08-2-0 |

2-in-1 ERGO™ Homeowner's Files with Two-Component Handle for Metal



ergo



**4-153**

|        |       |   |              |
|--------|-------|---|--------------|
|        |       |   |              |
| 200 mm | 1 & 1 | 5 | 4-153-08-1-2 |

Taper Saw Files Second Cut Unhandled



**4-183...-0**

|        |   |    |              |
|--------|---|----|--------------|
|        |   |    |              |
| 100 mm | 2 | 10 | 4-183-04-2-0 |
| 125 mm | 2 | 10 | 4-183-05-2-0 |
| 150 mm | 2 | 10 | 4-183-06-2-0 |
| 175 mm | 2 | 10 | 4-183-07-2-0 |
| 200 mm | 2 | 10 | 4-183-08-2-0 |
| 250 mm | 2 | 10 | 4-183-10-2-0 |

ERGO™ Mill Saw Files with Dual-Component Handle and 1 Round Edge Second Cut



ergo



**4-144...-2**

|        |   |   |              |
|--------|---|---|--------------|
|        |   |   |              |
| 200 mm | 2 | 5 | 4-144-08-2-2 |

4-in-2 ERGO™ Homeowner's File Set with Two-Component Handle for Wood and Metal



ergo



**4-154**

|        |       |    |              |
|--------|-------|----|--------------|
|        |       |    |              |
| 200 mm | 1 & 2 | 10 | 4-154-08-2-2 |

ERGO™ Taper Saw Files with Dual-Component Handle Second Cut



ergo



**4-183...-2**

|        |   |   |              |
|--------|---|---|--------------|
|        |   |   |              |
| 100 mm | 2 | 5 | 4-183-04-2-2 |
| 125 mm | 2 | 5 | 4-183-05-2-2 |
| 150 mm | 2 | 5 | 4-183-06-2-2 |
| 175 mm | 2 | 5 | 4-183-07-2-2 |
| 200 mm | 2 | 5 | 4-183-08-2-2 |

2-in-1 ERGO™ Homeowner's Files with Two-Component Handle for Wood & Metal



ergo



**4-152**

|        |       |   |              |
|--------|-------|---|--------------|
|        |       |   |              |
| 200 mm | 2 & 2 | 5 | 4-152-08-2-2 |

2-in-1 Farmer's own double Duty Files Bastard Cut



**4-155**

|        |   |    |              |
|--------|---|----|--------------|
|        |   |    |              |
| 200 mm | 1 | 10 | 4-155-08-2-0 |
| 250 mm | 1 | 5  | 4-155-10-2-0 |

Slim Taper Saw Files Second Cut Unhandled



**4-186...-0**

|        |   |    |              |
|--------|---|----|--------------|
|        |   |    |              |
| 100 mm | 2 | 10 | 4-186-04-2-0 |
| 125 mm | 2 | 10 | 4-186-05-2-0 |
| 150 mm | 2 | 10 | 4-186-06-2-0 |
| 175 mm | 2 | 10 | 4-186-07-2-0 |
| 200 mm | 2 | 10 | 4-186-08-2-0 |

ERGO™ Slim Taper Files with Dual-Component Handle Second Cut



**4-186...-2**



|        |   |   |              |
|--------|---|---|--------------|
| 100 mm | 2 | 5 | 4-186-04-2-2 |
| 125 mm | 2 | 5 | 4-186-05-2-2 |
| 150 mm | 2 | 5 | 4-186-06-2-2 |

Double Extra Slim Taper Saw Files Second Cut Unhandled



**4-188...-0**



|        |   |    |              |
|--------|---|----|--------------|
| 125 mm | 2 | 10 | 4-188-05-2-0 |
| 150 mm | 2 | 10 | 4-188-06-2-0 |

ERGO™ Double-Ended Saw Files with Dual-Component Handle Second Cut



**4-190...-2**



|        |   |   |              |
|--------|---|---|--------------|
| 150 mm | 2 | 5 | 4-190-06-2-2 |
| 175 mm | 2 | 5 | 4-190-07-2-2 |
| 200 mm | 2 | 5 | 4-190-08-2-2 |

Extra Slim Taper Saw Files Second Cut Unhandled



**4-187...-0**



|        |   |    |              |
|--------|---|----|--------------|
| 100 mm | 2 | 10 | 4-187-04-2-0 |
| 112 mm | 2 | 10 | 4-187-45-2-0 |
| 125 mm | 2 | 10 | 4-187-05-2-0 |
| 150 mm | 2 | 10 | 4-187-06-2-0 |
| 175 mm | 2 | 10 | 4-187-07-2-0 |

ERGO™ Double Extra Slim Taper Files with Dual-Component Handle Second Cut



**4-188...-2**



|        |   |   |              |
|--------|---|---|--------------|
| 125 mm | 2 | 5 | 4-188-05-2-2 |
|--------|---|---|--------------|

Tapered Bandsaw Files Second Cut Unhandled



**4-192...-0**



|        |   |    |              |
|--------|---|----|--------------|
| 150 mm | 2 | 10 | 4-192-06-2-0 |
| 175 mm | 2 | 10 | 4-192-07-2-0 |
| 200 mm | 2 | 10 | 4-192-08-2-0 |

ERGO™ Extra Slim Taper Files with Dual-Component Handle Second Cut



**4-187...-2**



|        |   |   |              |
|--------|---|---|--------------|
| 125 mm | 2 | 5 | 4-187-05-2-2 |
| 150 mm | 2 | 5 | 4-187-06-2-2 |

Double-Ended Saw Files with Wooden Handle Second Cut



**4-190...-0**



|        |   |    |              |
|--------|---|----|--------------|
| 175 mm | 2 | 10 | 4-190-07-2-0 |
| 200 mm | 2 | 10 | 4-190-08-2-0 |

ERGO™ Tapered Bandsaw Files with Dual-Component Handle Second Cut



**4-192...-2**



|        |   |   |              |
|--------|---|---|--------------|
| 150 mm | 2 | 5 | 4-192-06-2-2 |
| 200 mm | 2 | 5 | 4-192-08-2-2 |





Machine Bandsaw Files Second Cut



**4-202 - 4-204**

| Length | Files per Pack | Files per Box | Product Code |
|--------|----------------|---------------|--------------|
| 216 mm | 2              | 10            | 4-202-85-2-0 |
| 216 mm | 2              | 10            | 4-204-85-2-0 |

Wasa™ Double Edge Saw Files Smooth Cut Unhandled



**4-272...-0**

| Length | Files per Pack | Files per Box | Product Code |
|--------|----------------|---------------|--------------|
| 150 mm | 3              | 10            | 4-272-06-3-0 |

ERGO™ Wasa™ Double Edge Saw Files with Dual-Component Handle Smooth Cut



**4-272...-2**

| Length | Files per Pack | Files per Box | Product Code |
|--------|----------------|---------------|--------------|
| 125 mm | 3              | 5             | 4-272-05-3-2 |
| 150 mm | 3              | 5             | 4-272-06-3-2 |

**RASPS**

Flat Hand Rasps Medium Cut Unhandled



**6-344...-0**

| Length | Rasps per Pack | Rasps per Box | Product Code |
|--------|----------------|---------------|--------------|
| 200 mm | 2              | 10            | 6-344-08-2-0 |
| 250 mm | 2              | 10            | 6-344-10-2-0 |

ERGO™ Flat Hand Rasps Medium Cut



**6-344...-2**

| Length | Rasps per Pack | Rasps per Box | Product Code |
|--------|----------------|---------------|--------------|
| 200 mm | 2              | 5             | 6-344-08-2-2 |
| 250 mm | 2              | 5             | 6-344-10-2-2 |

Half-Round Rasps Coarse/Medium Cut Unhandled



**6-342...-0**

| Length | Rasps per Pack | Rasps per Box | Product Code |
|--------|----------------|---------------|--------------|
| 150 mm | 2              | 10            | 6-342-06-2-0 |
| 200 mm | 1              | 10            | 6-342-08-1-0 |
| 200 mm | 2              | 10            | 6-342-08-2-0 |
| 250 mm | 1              | 10            | 6-342-10-1-0 |
| 250 mm | 2              | 10            | 6-342-10-2-0 |

ERGO™ Half-Round Rasps Coarse/Medium Cut



**6-342...-2**

| Length | Rasps per Pack | Rasps per Box | Product Code |
|--------|----------------|---------------|--------------|
| 150 mm | 2              | 5             | 6-342-06-2-2 |
| 200 mm | 1              | 5             | 6-342-08-1-2 |
| 200 mm | 2              | 5             | 6-342-08-2-2 |
| 250 mm | 1              | 5             | 6-342-10-1-2 |
| 250 mm | 2              | 5             | 6-342-10-2-2 |

Half-Round Cabinet Rasps Medium/Fine Cut Unhandled



**6-343...-0**

| Length | Rasps per Pack | Rasps per Box | Product Code |
|--------|----------------|---------------|--------------|
| 200 mm | 2              | 10            | 6-343-08-2-0 |
| 200 mm | 3              | 10            | 6-343-08-3-0 |
| 250 mm | 2              | 10            | 6-343-10-2-0 |
| 250 mm | 3              | 10            | 6-343-10-3-0 |

ERGO™ Half-Round Cabinet Rasps Medium Cut



**6-343...-2**

| Length | Rasps per Pack | Rasps per Box | Product Code |
|--------|----------------|---------------|--------------|
| 200 mm | 2              | 5             | 6-343-08-2-2 |
| 250 mm | 2              | 5             | 6-343-10-2-2 |

Round Rasps Medium Cut Unhandled



**6-345...-0**

|        |   |    |              |
|--------|---|----|--------------|
|        |   |    |              |
| 200 mm | 2 | 10 | 6-345-08-2-0 |
| 250 mm | 2 | 10 | 6-345-10-2-0 |

ERGO™ Round Rasps Coarse/Medium Cut



**6-345...-2**

|        |   |   |              |
|--------|---|---|--------------|
|        |   |   |              |
| 200 mm | 1 | 5 | 6-345-08-1-2 |
| 200 mm | 2 | 5 | 6-345-08-2-2 |
| 250 mm | 1 | 5 | 6-345-10-1-2 |

ERGO™ Rasp File Set Second Cut - 3 Pcs



**6-470**

|        |   |   |              |
|--------|---|---|--------------|
|        |   |   |              |
| 200 mm | 2 | 5 | 6-470-08-2-2 |

6-345-08-2-2

6-342-08-2-2

4-152-08-2-2

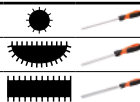

**MILLED TOOTH FILES**

Pansar® Milled Tooth Flat Blades Bastard/Second Cut Unhandled



**3-330**

|        |   |   |              |
|--------|---|---|--------------|
|        |   |   |              |
| 300 mm | 1 | 5 | 3-330-12-1-0 |
| 300 mm | 2 | 5 | 3-330-12-2-0 |
| 350 mm | 1 | 5 | 3-330-14-1-0 |
| 350 mm | 2 | 5 | 3-330-14-2-0 |

Pansar® Milled Tooth Half-Round Blades Bastard Cut Unhandled



**3-331**

|        |   |   |              |
|--------|---|---|--------------|
|        |   |   |              |
| 350 mm | 1 | 5 | 3-331-14-1-0 |

ERGO™ Milled Tooth Filemasters with Two-component handle



**FM10**

|        |       |   |      |
|--------|-------|---|------|
|        |       |   |      |
| 300 mm | 4 & 5 | 5 | FM12 |
| 250 mm | 4 & 5 | 5 | FM10 |

ERGO™ Milled Tooth Half-Round Filemasters with Two-component handle



**HRFM10**

|        |   |   |        |
|--------|---|---|--------|
|        |   |   |        |
| 250 mm | 5 | 5 | HRFM10 |

**NEEDLE FILES**

Needle Flat Files Bastard/Second/Smooth/Dead Smooth Cut Unhandled



**2-300**

|        |   |    |              |
|--------|---|----|--------------|
|        |   |    |              |
| 140 mm | 0 | 10 | 2-300-14-0-0 |
| 140 mm | 2 | 10 | 2-300-14-2-0 |
| 140 mm | 4 | 10 | 2-300-14-4-0 |
| 160 mm | 0 | 10 | 2-300-16-0-0 |
| 160 mm | 1 | 10 | 2-300-16-1-0 |
| 160 mm | 2 | 10 | 2-300-16-2-0 |
| 160 mm | 4 | 10 | 2-300-16-4-0 |
| 180 mm | 0 | 10 | 2-300-18-0-0 |
| 180 mm | 2 | 10 | 2-300-18-2-0 |

Needle Flat Files with Tapered Edge Bastard/Second/Smooth Cut Unhandled



**2-301**

|        |   |    |              |
|--------|---|----|--------------|
|        |   |    |              |
| 140 mm | 0 | 10 | 2-301-14-0-0 |
| 140 mm | 2 | 10 | 2-301-14-2-0 |
| 160 mm | 0 | 10 | 2-301-16-0-0 |
| 160 mm | 1 | 10 | 2-301-16-1-0 |
| 160 mm | 2 | 10 | 2-301-16-2-0 |



Needle Half-Round Files Bastard/Second/  
Smooth/Dead Smooth Cut Unhandled



**2-304**

| Length | Coarse | Second | Smooth | Dead Smooth | Part No.     |
|--------|--------|--------|--------|-------------|--------------|
| 140 mm | 0      | 10     |        |             | 2-304-14-0-0 |
| 140 mm | 2      | 10     |        |             | 2-304-14-2-0 |
| 140 mm | 4      | 10     |        |             | 2-304-14-4-0 |
| 160 mm | 0      | 10     |        |             | 2-304-16-0-0 |
| 160 mm | 1      | 10     |        |             | 2-304-16-1-0 |
| 160 mm | 2      | 10     |        |             | 2-304-16-2-0 |
| 160 mm | 4      | 10     |        |             | 2-304-16-4-0 |
| 180 mm | 0      | 10     |        |             | 2-304-18-0-0 |
| 180 mm | 2      | 10     |        |             | 2-304-18-2-0 |

Needle Half-Round Files Bastard Cut  
Unhandled



**2-313**

| Length | Coarse | Second | Smooth | Dead Smooth | Part No.     |
|--------|--------|--------|--------|-------------|--------------|
| 160 mm | 0      | 10     |        |             | 2-313-16-0-0 |

Needle Round Files Bastard/Second/  
Smooth/Dead Smooth Cut Unhandled



**2-307**

| Length | Coarse | Second | Smooth | Dead Smooth | Part No.     |
|--------|--------|--------|--------|-------------|--------------|
| 140 mm | 0      | 10     |        |             | 2-307-14-0-0 |
| 140 mm | 2      | 10     |        |             | 2-307-14-2-0 |
| 140 mm | 4      | 10     |        |             | 2-307-14-4-0 |
| 160 mm | 0      | 10     |        |             | 2-307-16-0-0 |
| 160 mm | 1      | 10     |        |             | 2-307-16-1-0 |
| 160 mm | 2      | 10     |        |             | 2-307-16-2-0 |
| 160 mm | 4      | 10     |        |             | 2-307-16-4-0 |
| 180 mm | 0      | 10     |        |             | 2-307-18-0-0 |
| 180 mm | 2      | 10     |        |             | 2-307-18-2-0 |

Needle Oval Files Second/Smooth Cut  
Unhandled



**2-305**

| Length | Coarse | Second | Smooth | Dead Smooth | Part No.     |
|--------|--------|--------|--------|-------------|--------------|
| 160 mm | 1      | 10     |        |             | 2-305-16-1-0 |
| 160 mm | 2      | 10     |        |             | 2-305-16-2-0 |

Needle Crossing Files Second/Smooth Cut  
Unhandled



**2-306**

| Length | Coarse | Second | Smooth | Dead Smooth | Part No.     |
|--------|--------|--------|--------|-------------|--------------|
| 160 mm | 1      | 10     |        |             | 2-306-16-1-0 |
| 160 mm | 2      | 10     |        |             | 2-306-16-2-0 |

Needle Three Square Files Bastard/  
Second/Smooth/Dead Smooth Cut  
Unhandled



**2-302**

| Length | Coarse | Second | Smooth | Dead Smooth | Part No.     |
|--------|--------|--------|--------|-------------|--------------|
| 140 mm | 0      | 10     |        |             | 2-302-14-0-0 |
| 140 mm | 2      | 10     |        |             | 2-302-14-2-0 |
| 140 mm | 4      | 10     |        |             | 2-302-14-4-0 |
| 160 mm | 0      | 10     |        |             | 2-302-16-0-0 |
| 160 mm | 1      | 10     |        |             | 2-302-16-1-0 |
| 160 mm | 2      | 10     |        |             | 2-302-16-2-0 |
| 160 mm | 4      | 10     |        |             | 2-302-16-4-0 |
| 180 mm | 0      | 10     |        |             | 2-302-18-0-0 |
| 180 mm | 2      | 10     |        |             | 2-302-18-2-0 |

Needle Barrette Files Smooth/Dead  
Smooth Cut Unhandled



**2-309**

| Length | Coarse | Second | Smooth | Dead Smooth | Part No.     |
|--------|--------|--------|--------|-------------|--------------|
| 160 mm | 2      | 10     |        |             | 2-309-16-2-0 |
| 160 mm | 4      | 10     |        |             | 2-309-16-4-0 |

Needle Knife Files Bastard/Second/  
Smooth Cut Unhandled



**2-308**

| Length | Coarse | Second | Smooth | Dead Smooth | Part No.     |
|--------|--------|--------|--------|-------------|--------------|
| 140 mm | 2      | 10     |        |             | 2-308-14-2-0 |
| 160 mm | 0      | 10     |        |             | 2-308-16-0-0 |
| 160 mm | 1      | 10     |        |             | 2-308-16-1-0 |
| 160 mm | 2      | 10     |        |             | 2-308-16-2-0 |

Needle Square Files Bastard/Second/  
Smooth/Dead Smooth Cut Unhandled



**2-303**

| Length | Coarse | Second | Smooth | Dead Smooth | Part No.     |
|--------|--------|--------|--------|-------------|--------------|
| 140 mm | 2      | 10     |        |             | 2-303-14-2-0 |
| 160 mm | 0      | 10     |        |             | 2-303-16-0-0 |
| 160 mm | 1      | 10     |        |             | 2-303-16-1-0 |
| 160 mm | 2      | 10     |        |             | 2-303-16-2-0 |
| 160 mm | 4      | 10     |        |             | 2-303-16-4-0 |
| 180 mm | 0      | 10     |        |             | 2-303-18-0-0 |
| 180 mm | 2      | 10     |        |             | 2-303-18-2-0 |

Needle File Set Bastard Cut Unhandled  
140 mm - 6 Pcs

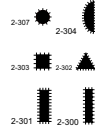

**2-470**

|        |   |    |              |
|--------|---|----|--------------|
|        |   |    |              |
| 140 mm | 0 | 10 | 2-470-14-0-0 |

|              |  |
|--------------|--|
| 9-488-02-10  |  |
| 2-304-14-0-0 |  |
| 2-300-14-0-0 |  |
| 2-303-14-0-0 |  |
| 2-302-14-0-0 |  |
| 2-301-14-0-0 |  |
| 2-307-14-0-0 |  |

Needle File Set Smooth Cut Unhandled  
140 mm - 6 Pcs



**2-470-14-2-0**

|        |   |    |              |
|--------|---|----|--------------|
|        |   |    |              |
| 140 mm | 2 | 10 | 2-470-14-2-0 |

|              |  |
|--------------|--|
| 9-488-02-10  |  |
| 2-304-14-2-0 |  |
| 2-300-14-2-0 |  |
| 2-303-14-2-0 |  |
| 2-302-14-2-0 |  |
| 2-301-14-2-0 |  |
| 2-307-14-2-0 |  |

Needle File Set Dead Smooth Cut  
Unhandled 140 mm - 6 Pcs



**2-470-14-4-0**

|        |   |    |              |
|--------|---|----|--------------|
|        |   |    |              |
| 140 mm | 4 | 10 | 2-470-14-4-0 |

|                            |  |
|----------------------------|--|
| 9-488-02-10                |  |
| 2-304-14-4-0               |  |
| 2-300-14-4-0               |  |
| 2-303-14-4-0, 2-301-14-4-0 |  |
| 2-302-14-4-0               |  |
| 2-307-14-4-0               |  |

Needle File Set Second Cut Unhandled  
160 mm - 6 Pcs



**2-470-16-1-0**

|        |   |    |              |
|--------|---|----|--------------|
|        |   |    |              |
| 160 mm | 1 | 10 | 2-470-16-1-0 |

|              |  |
|--------------|--|
| 9-488-02-10  |  |
| 2-304-16-1-0 |  |
| 2-300-16-1-0 |  |
| 2-303-16-1-0 |  |
| 2-302-16-1-0 |  |
| 2-301-16-1-0 |  |
| 2-307-16-1-0 |  |

Needle File Set Smooth Cut Unhandled  
160 mm - 6 Pcs



**2-470-16-2-0**

|        |   |    |              |
|--------|---|----|--------------|
|        |   |    |              |
| 160 mm | 2 | 10 | 2-470-16-2-0 |

|              |  |
|--------------|--|
| 9-488-02-10  |  |
| 2-304-16-2-0 |  |
| 2-300-16-2-0 |  |
| 2-303-16-2-0 |  |
| 2-302-16-2-0 |  |
| 2-301-16-2-0 |  |
| 2-307-16-2-0 |  |

Needle File Set Second Cut Unhandled  
160 mm - 9 Pcs



**2-471**

|        |   |   |              |
|--------|---|---|--------------|
|        |   |   |              |
| 160 mm | 1 | 5 | 2-471-16-1-0 |

|              |  |
|--------------|--|
| 9-488-02-10  |  |
| 2-303-16-1-0 |  |
| 2-304-16-1-0 |  |
| 2-302-16-1-0 |  |
| 2-300-16-1-0 |  |
| 2-308-16-1-0 |  |
| 2-301-16-1-0 |  |
| 2-306-16-1-0 |  |
| 2-305-16-1-0 |  |
| 2-307-16-1-0 |  |



Needle File Set Bastard Cut Unhandled  
140 mm - 12 Pcs



**2-472**



140 mm 0 5 2-472-14-0-0

2-303-14-0-0, 2-313-14-0-0, 2-309-14-0-0, 2-306-14-0-0

|              |  |
|--------------|--|
| 2-300-14-0-0 |  |
| 2-301-14-0-0 |  |
| 2-304-14-0-0 |  |
| 2-302-14-0-0 |  |
| 2-307-14-0-0 |  |
| 9-488-02-10  |  |

Needle File Set Smooth Cut Unhandled  
140 mm - 12 Pcs



**2-472-14-2-0**



140 mm 2 5 2-472-14-2-0

|                            |  |
|----------------------------|--|
| 2-303-14-2-0               |  |
| 2-300-14-2-0               |  |
| 2-301-14-2-0               |  |
| 2-304-14-2-0               |  |
| 2-302-14-2-0               |  |
| 2-313-14-2-0, 2-306-14-2-0 |  |
| 2-307-14-2-0               |  |
| 2-308-14-2-0               |  |
| 9-488-02-10                |  |

Needle File Set Bastard Cut Unhandled  
160 mm - 12 Pcs



**2-472-16-0-0**



160 mm 0 5 2-472-16-0-0

|              |  |
|--------------|--|
| 2-303-16-0-0 |  |
| 2-300-16-0-0 |  |
| 2-301-16-0-0 |  |
| 2-304-16-0-0 |  |
| 2-302-16-0-0 |  |
| 2-313-16-0-0 |  |
| 2-307-16-0-0 |  |
| 2-306-16-0-0 |  |
| 2-308-16-0-0 |  |
| 9-488-02-10  |  |

Needle File Set Second Cut Unhandled  
160 mm - 12 Pcs



**2-472-16-1-0**



160 mm 1 5 2-472-16-1-0

2-312-16-1-0, 2-313-16-1-0, 2-309-16-1-0

|              |  |
|--------------|--|
| 2-300-16-1-0 |  |
| 2-301-16-1-0 |  |
| 2-302-16-1-0 |  |
| 2-303-16-1-0 |  |
| 2-304-16-1-0 |  |
| 2-306-16-1-0 |  |
| 2-307-16-1-0 |  |
| 2-308-16-1-0 |  |
| 2-309-16-2-0 |  |
| 2-311-16-2-0 |  |
| 2-313-16-2-0 |  |
| 9-488-02-10  |  |

Needle File Set Smooth Cut Unhandled  
160 mm - 12 Pcs



**2-472-16-2-0**

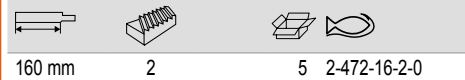

160 mm 2 5 2-472-16-2-0

2-312-16-2-0

|              |  |
|--------------|--|
| 2-303-16-2-0 |  |
| 2-300-16-2-0 |  |
| 2-301-16-2-0 |  |
| 2-311-16-2-0 |  |
| 2-304-16-2-0 |  |
| 2-302-16-2-0 |  |
| 2-313-16-2-0 |  |
| 2-307-16-2-0 |  |
| 2-309-16-2-0 |  |
| 2-306-16-2-0 |  |
| 2-308-16-2-0 |  |
| 9-488-02-10  |  |

**DIAMOND FILES**

Diamond Precision Needle Files  
Unhandled



**2-300-D - 2-304-D**



|        |    |               |
|--------|----|---------------|
| 140 mm | 10 | 2-300-14-D-1P |
| 160 mm | 10 | 2-300-16-D-1P |
| 140 mm | 1  | 2-301-14-D-1P |
| 140 mm | 10 | 2-302-14-D-1P |
| 160 mm | 10 | 2-302-16-D-1P |
| 140 mm | 10 | 2-303-14-D-1P |
| 160 mm | 1  | 2-303-16-D-1P |
| 140 mm | 10 | 2-304-14-D-1P |
| 160 mm | 10 | 2-304-16-D-1P |

Diamond Precision Needle Files  
Unhandled 140/160 mm



**2-306-D - 2-308-D**

|        |    |               |
|--------|----|---------------|
|        |    |               |
| 140 mm | 1  | 2-306-14-D-1P |
| 140 mm | 10 | 2-307-14-D-1P |
| 160 mm | 10 | 2-307-16-D-1P |
| 140 mm | 1  | 2-308-14-D-1P |

Universal Handle for Needle Files



**9-488-02**

|     |    |             |
|-----|----|-------------|
|     |    |             |
| 5 g | 10 | 9-488-02-10 |

Steel Wire File Cards with Wooden Handle



**9-469**

|        |        |   |              |
|--------|--------|---|--------------|
|        |        |   |              |
| 110 mm | 240 mm | 1 | 9-469-00-0-0 |

Diamond Precision Files Integrated handle



**5-600-D - 5-670-D**

|        |    |               |
|--------|----|---------------|
|        |    |               |
| 215 mm | 10 | 5-600-21-D-1P |
| 215 mm | 5  | 5-610-21-D-1P |
| 215 mm | 1  | 5-630-21-D-1P |
| 215 mm | 1  | 5-670-21-D-1P |

Plastic Handles for 8" Round Chainsaw Files



**PH-6604**

|      |    |            |
|------|----|------------|
|      |    |            |
| 55 g | 15 | PH-6604-1P |
| 50 g | 25 | PH-6604-25 |

ERGO™ Round Shaped Handles for Small files - 10 Pcs Loose



**9-484...10**

|     |        |    |              |
|-----|--------|----|--------------|
|     |        |    |              |
| 3.2 | 3.2 mm | 10 | 9-484-3.2-10 |
| 5.2 | 5.2 mm | 10 | 9-484-5.2-10 |

**ACCESSORIES**

Aluminum Holders for Pansar® 3-330 14" Flat Blade



**9-462**

|        |   |              |
|--------|---|--------------|
|        |   |              |
| 350 mm | 5 | 9-462-14-0-0 |

File Cleaners with Steel Wire Card



**9-467**

|        |        |   |              |
|--------|--------|---|--------------|
|        |        |   |              |
| 130 mm | 260 mm | 1 | 9-467-00-0-0 |

ERGO™ Round Shaped Handles for Small files - 1 Pck Carded



**9-484...1P**

|     |        |    |              |
|-----|--------|----|--------------|
|     |        |    |              |
| 3.2 | 3.2 mm | 10 | 9-484-3.2-1P |
| 5.2 | 5.2 mm | 10 | 9-484-5.2-1P |





ERGO™ Oval Shaped Handles for Flat & Half-Round Files - 10 Pcs Loose



ergo®



**9-485...10**

| File Size | File Width | Quantity | Part Number |
|-----------|------------|----------|-------------|
| 4         | 4 mm       | 10       | 9-485-04-10 |
| 5         | 5 mm       | 10       | 9-485-05-10 |
| 6         | 6 mm       | 10       | 9-485-06-10 |
| 9         | 9 mm       | 10       | 9-485-09-10 |
| 13        | 13 mm      | 10       | 9-485-13-10 |

ERGO™ Handles for Round Chainsaw Files - 1 Pck Carded



ergo®



**9-486-C-1P**

| File Size | File Width | Quantity | Part Number |
|-----------|------------|----------|-------------|
| 3.2       | 3.2 mm     | 10       | 9-486-C-1P  |

ERGO™ Oval Shaped Handles for Flat & Half-Round Files - 1 Pck Carded



ergo®



**9-485...1P**

| File Size | File Width | Quantity | Part Number |
|-----------|------------|----------|-------------|
| 4         | 4 mm       | 10       | 9-485-04-1P |
| 5         | 5 mm       | 10       | 9-485-05-1P |
| 6         | 6 mm       | 20       | 9-485-06-1P |
| 9         | 9 mm       | 20       | 9-485-09-1P |
| 13        | 13 mm      | 1        | 9-485-13-1P |

ERGO™ Round Shaped Handles for Shaped Files - 10 Pcs Loose



ergo®



**9-486...10**

| File Size | File Width | Quantity | Part Number |
|-----------|------------|----------|-------------|
| 4         | 4 mm       | 10       | 9-486-04-10 |
| 5         | 5 mm       | 10       | 9-486-05-10 |
| 7         | 7 mm       | 10       | 9-486-07-10 |
| 8         | 8 mm       | 10       | 9-486-08-10 |

ERGO™ Handles for Round Chainsaw Files - 10 Pcs Loose



ergo®



**9-486-C-10**

| File Size | File Width | Quantity | Part Number |
|-----------|------------|----------|-------------|
| 3.2       | 3.2 mm     | 10       | 9-486-C-10  |

ERGO™ Round Shaped Handles for Shaped Files - 1 Pck Carded



ergo®



**9-486...1P**

| File Size | File Width | Quantity | Part Number |
|-----------|------------|----------|-------------|
| 4         | 4 mm       | 20       | 9-486-04-1P |
| 5         | 5 mm       | 20       | 9-486-05-1P |
| 7         | 7 mm       | 20       | 9-486-07-1P |



## Wrenches



## ADJUSTABLE WRENCHES

ERGO™ Central Nut Adjustable Wrenches with Rubber Handle and Phosphate Finish



ergo



### 90

| L         | Hand  | Box | Icon |
|-----------|-------|-----|------|
| 158mm/6"  | 20 mm | 5   | 9070 |
| 208mm/8"  | 27 mm | 5   | 9071 |
| 257mm/10" | 31 mm | 5   | 9072 |
| 308mm/12" | 34 mm | 5   | 9073 |

ERGO™ rubber handle central nut phosphated adjustable wrench, with reversible jaw.



ergo



### 90P

| L         | Hand  | Box | Icon   |
|-----------|-------|-----|--------|
| 158mm/6"  | 21 mm | 5   | 9070 P |
| 208mm/8"  | 28 mm | 5   | 9071 P |
| 257mm/10" | 33 mm | 5   | 9072 P |
| 308mm/12" | 35 mm | 5   | 9073 P |

ERGO™ Central Nut Adjustable Wrenches with Rubber Handle and Chrome Finish



ergo



### 90C

| L         | Hand  | Box | Icon   |
|-----------|-------|-----|--------|
| 158mm/6"  | 20 mm | 5   | 9070 C |
| 208mm/8"  | 27 mm | 5   | 9071 C |
| 257mm/10" | 31 mm | 5   | 9072 C |
| 308mm/12" | 34 mm | 3   | 9073 C |

ERGO™ Rubber Handle Central Nut Adjustable Wrenches, with reversible jaw.



ergo



### 90PC

| L         | Hand  | Box | Icon    |
|-----------|-------|-----|---------|
| 158mm/6"  | 21 mm | 5   | 9070 PC |
| 208mm/8"  | 28 mm | 5   | 9071 PC |
| 257mm/10" | 33 mm | 5   | 9072 PC |
| 308mm/12" | 35 mm | 3   | 9073 PC |

ERGO™ Central Nut Wide Opening Jaw Adjustable Wrenches with Rubber Handle and Phosphate Finish



ergo



### 9029-9035

| L         | Hand  | Box | Icon |
|-----------|-------|-----|------|
| 170mm/6"  | 32 mm | 5   | 9029 |
| 218mm/8"  | 38 mm | 5   | 9031 |
| 270mm/10" | 46 mm | 5   | 9033 |
| 324mm/12" | 55 mm | 5   | 9035 |

ERGO™ Central Nut Wide Opening Jaw Adjustable Wrenches with Rubber Handle and Chrome Finish



ergo



### 9029C/9031C

| L        | Hand  | Box | Icon   |
|----------|-------|-----|--------|
| 170mm/6" | 32 mm | 5   | 9029 C |
| 218mm/8" | 38 mm | 5   | 9031 C |

ERGO™ Central Nut Wide Opening Thin Jaw Adjustable Wrenches with Rubber Handle



ergo



### 9029-T/9031-T

| L        | Hand  | Box | Icon   |
|----------|-------|-----|--------|
| 170mm/6" | 32 mm | 5   | 9029-T |
| 218mm/8" | 38 mm | 5   | 9031-T |

ERGO™ Central Nut Reversible Extra Wide Opening Jaw Adjustable Wrenches with Rubber Handle



ergo



### 9031P

| L        | Hand  | Box | Icon  |
|----------|-------|-----|-------|
| 218mm/8" | 39 mm | 5   | 9031P |

ERGO™ Central Nut Adjustable Wrench Set with Rubber Handle



ergo



### ADJUST3-90

| g     | Box | Icon        |
|-------|-----|-------------|
| 900 g | 1   | ADJUST 3-90 |

9070, 9071, 9072



ERGO™ Adjustable Wrenches Twin Pack



**ADJUST9031/29**



550 g



3 ADJUST 9031/29

9029, 9031



Central Nut Adjustable Wrenches with Phosphate Finish



**80**

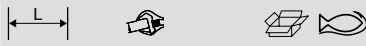

| L         | mm    | mm | Qty     | Part No. |
|-----------|-------|----|---------|----------|
| 110mm/4"  | 13 mm | 5  | 8069    |          |
| 155mm/6"  | 20 mm | 5  | 8070    |          |
| 205mm/8"  | 27 mm | 5  | 8071    |          |
| 255mm/10" | 31 mm | 5  | 8072    |          |
| 305mm/12" | 34 mm | 5  | 8073    |          |
| 380mm/15" | 44 mm | 3  | 8074    |          |
| 455mm/18" | 53 mm | 3  | 8075    |          |
| 110mm/4"  | 13 mm | 50 | 8069 IP |          |
| 155mm/6"  | 20 mm | 40 | 8070 IP |          |
| 205mm/8"  | 27 mm | 50 | 8071 IP |          |
| 255mm/10" | 31 mm | 30 | 8072 IP |          |
| 305mm/12" | 34 mm | 20 | 8073 IP |          |
| 380mm/15" | 44 mm | 20 | 8074 IP |          |
| 455mm/18" | 53 mm | 10 | 8075 IP |          |

Standard Central Nut Adjustable Wrenches with Chrome Finish



**80C**



| L         | mm    | mm | Qty    | Part No. |
|-----------|-------|----|--------|----------|
| 110mm/4"  | 13 mm | 5  | 8069 C |          |
| 155mm/6"  | 20 mm | 5  | 8070 C |          |
| 205mm/8"  | 27 mm | 5  | 8071 C |          |
| 255mm/10" | 31 mm | 5  | 8072 C |          |
| 305mm/12" | 34 mm | 5  | 8073 C |          |
| 380mm/15" | 44 mm | 3  | 8074 C |          |
| 455mm/18" | 53 mm | 3  | 8075 C |          |



| L         | mm    | mm | Qty       | Part No. |
|-----------|-------|----|-----------|----------|
| 110mm/4"  | 13 mm | 5  | 8069 C IP |          |
| 155mm/6"  | 20 mm | 5  | 8070 C IP |          |
| 205mm/8"  | 27 mm | 5  | 8071 C IP |          |
| 255mm/10" | 31 mm | 5  | 8072 C IP |          |
| 305mm/12" | 34 mm | 5  | 8073 C IP |          |
| 380mm/15" | 44 mm | 3  | 8074 C IP |          |
| 455mm/18" | 53 mm | 3  | 8075 C IP |          |

Standard Central Nut Adjustable Wrenches with Phosphate Finish



**86/87**



| L         | mm    | mm | Qty | Part No. |
|-----------|-------|----|-----|----------|
| 614mm/24" | 63 mm | 1  | 86  |          |
| 770mm/30" | 85 mm | 3  | 87  |          |

Standard Central Nut Adjustable Wrench Set



**ADJUST3**

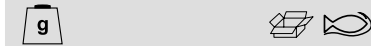

810 g 1 ADJUST 3

8070, 8071, 8072

Spare Jaw for Central Nut Adjustable Wrenches



**RPS**

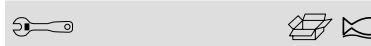

| Part No.                   | Qty | Part No. |
|----------------------------|-----|----------|
| 8069, 8069 C               | 1   | 8069-1   |
| 8070, 8070 C, 9070, 9070 C | 1   | 8070-1   |
| 8071, 8071 C, 9071, 9071 C | 1   | 8071-1   |



| Part No.                   | Qty | Part No. |
|----------------------------|-----|----------|
| 8072, 8072 C, 9072, 9072 C | 1   | 8072-1   |
| 8073, 8073 C, 9073, 9073 C | 1   | 8073-1   |
| 8074, 8074 C               | 1   | 8074-1   |
| 8075, 8075 C               | 1   | 8075-1   |
| 9029, 9029 C, 31           | 1   | 9029-1   |
| 9029-T                     | 1   | 9029T-1  |
| 9031, 9031 C               | 1   | 9031-1   |
| 9031-T                     | 1   | 9031T-1  |
| 9033, 33H                  | 1   | 9033-1   |
| 9035                       | 1   | 9035-1   |
| 86                         | 1   | 86-1     |
| 87                         | 1   | 87-1     |
| 9031 P                     | 1   | 9031 P-1 |
| 9070 P, 9070 PC            | 1   | 9070 P-1 |
| 9071 P, 9071 PC            | 1   | 9071 P-1 |
| 9072 P, 9072 PC            | 1   | 9072 P-1 |
| 9073 P, 9073 PC            | 1   | 9073 P-1 |

Spare Knurl, Pin & Spring for Central Nut Adjustable Wrenches



**RPS2**

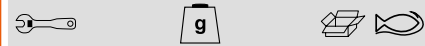

| Part No.  | g     | Qty | Part No. |
|---|-------|-----|----------|
| 8069, 8069 C  | 3 g   | 1   | 8069-2   |
| 8070, 8070 C, 9070, 9070 C, 9070 P, 9070 PC           | 8 g   | 1   | 8070-2   |
| 8071, 8071 C, 9071, 9071 C, 9071 P, 9071 PC           | 10 g  | 1   | 8071-2   |
| 8072, 8072 C, 9072, 9072 C, 9072 P, 9072 PC           | 16 g  | 1   | 8072-2   |
| 8073, 8073 C, 9073, 9073 C, 9073 P, 9073 PC, 9033     | 25 g  | 1   | 8073-2   |
| 8074, 8074 C, 9035                                    | 47 g  | 1   | 8074-2   |
| 8075, 8075 C  | 54 g  | 1   | 8075-2   |
| 9029, 9029 C, 9029-T, 9031-T, 31, 9031, 9031 C, 9031P | 9 g   | 1   | 9029-2   |
| 86  | 125 g | 1   | 86-2     |
| 87  | 185 g | 1   | 87-2     |



Podger Adjustable Wrenches with Phosphate Finish



**84**

|           |       |   |           |
|-----------|-------|---|-----------|
|           |       |   |           |
| 405mm/16" | 41 mm | 1 | 84-PODGER |

Wide Jaw Adjustable Wrenches with Serrated Pipe Jaws and Phosphate Finish



**31**

|          |       |    |       |
|----------|-------|----|-------|
|          |       |    |       |
| 209mm/8" | 32 mm | 5  | 31    |
| 209mm/8" | 32 mm | 50 | 31 IP |

Thin Jaw Adjustable Spanners with Serrated Pipe Jaws & Phosphate Finish



**31-T**

|          |       |    |         |
|----------|-------|----|---------|
|          |       |    |         |
| 209mm/8" | 32 mm | 5  | 31-T    |
| 209mm/8" | 32 mm | 50 | 31-T IP |

Wide Jaw Adjustable Wrenches with Hook and Phosphate Finish



**33H**

|           |       |   |     |
|-----------|-------|---|-----|
|           |       |   |     |
| 254mm/10" | 46 mm | 5 | 33H |

Side Nut Heavy Duty Adjustable Wrenches with Rubber Handle and Phosphate Finish



**95**

|           |       |   |      |
|-----------|-------|---|------|
|           |       |   |      |
| 257mm/10" | 35 mm | 5 | 9572 |

Side Nut Adjustable Wrenches with Chrome Finish



**91C/97C**

|           |       |   |     |
|-----------|-------|---|-----|
|           |       |   |     |
| 155mm/6"  | 21 mm | 5 | 91C |
| 205mm/8"  | 29 mm | 5 | 92C |
| 255mm/10" | 34 mm | 5 | 93C |
| 305mm/12" | 39 mm | 5 | 94C |
| 405mm/16" | 48 mm | 1 | 95C |
| 500mm/20" | 60 mm | 1 | 96C |
| 750mm/30" | 77 mm | 1 | 97C |



**COMBINATION WRENCHES**

Metric Flat Combination Wrenches with Chrome Finish



**111M**



|        |  |    |            |
|--------|--|----|------------|
|        |  |    |            |
| 5.5 mm |  | 10 | 111M-5.5   |
| 6 mm   |  | 10 | 111M-6     |
| 7 mm   |  | 10 | 111M-7     |
| 8 mm   |  | 10 | 111M-8     |
| 9 mm   |  | 10 | 111M-9     |
| 10 mm  |  | 10 | 111M-10    |
| 11 mm  |  | 10 | 111M-11    |
| 12 mm  |  | 10 | 111M-12    |
| 13 mm  |  | 10 | 111M-13    |
| 14 mm  |  | 10 | 111M-14    |
| 15 mm  |  | 10 | 111M-15    |
| 16 mm  |  | 10 | 111M-16    |
| 17 mm  |  | 10 | 111M-17    |
| 18 mm  |  | 10 | 111M-18    |
| 19 mm  |  | 10 | 111M-19    |
| 20 mm  |  | 10 | 111M-20    |
| 21 mm  |  | 10 | 111M-21    |
| 22 mm  |  | 5  | 111M-22    |
| 23 mm  |  | 5  | 111M-23    |
| 24 mm  |  | 5  | 111M-24    |
| 25 mm  |  | 5  | 111M-25    |
| 26 mm  |  | 5  | 111M-26    |
| 27 mm  |  | 5  | 111M-27    |
| 28 mm  |  | 5  | 111M-28    |
| 29 mm  |  | 5  | 111M-29    |
| 30 mm  |  | 5  | 111M-30    |
| 32 mm  |  | 5  | 111M-32    |
| 33 mm  |  | 5  | 111M-33    |
| 34 mm  |  | 5  | 111M-34    |
| 36 mm  |  | 1  | 111M-36    |
| 38 mm  |  | 1  | 111M-38    |
| 41 mm  |  | 1  | 111M-41    |
| 46 mm  |  | 1  | 111M-46    |
| 50 mm  |  | 1  | 111M-50    |
| 55 mm  |  | 1  | 111M-55    |
| 60 mm  |  | 1  | 111M-60    |
| 65 mm  |  | 1  | 111M-65    |
| 70 mm  |  | 1  | 111M-70    |
| 75 mm  |  | 1  | 111M-75    |
| 80 mm  |  | 1  | 111M-80    |
| 85 mm  |  | 1  | 111M-85    |
| 90 mm  |  | 1  | 111M-90    |
| 95 mm  |  | 1  | 111M-95    |
| 100 mm |  | 1  | 111M-100   |
| 5.5 mm |  | 1  | SB111M-5,5 |
| 6 mm   |  | 1  | SB111M-6   |
| 7 mm   |  | 1  | SB111M-7   |
| 8 mm   |  | 1  | SB111M-8   |
| 9 mm   |  | 1  | SB111M-9   |
| 10 mm  |  | 1  | SB111M-10  |
| 11 mm  |  | 1  | SB111M-11  |
| 12 mm  |  | 1  | SB111M-12  |
| 13 mm  |  | 1  | SB111M-13  |
| 14 mm  |  | 1  | SB111M-14  |
| 15 mm  |  | 1  | SB111M-15  |

|    |             |
|--|-------------|
| 16 mm  | 1 SB111M-16 |
| 17 mm  | 1 SB111M-17 |
| 18 mm  | 1 SB111M-18 |
| 19 mm  | 1 SB111M-19 |
| 20 mm  | 1 SB111M-20 |
| 21 mm  | 1 SB111M-21 |
| 22 mm  | 1 SB111M-22 |
| 23 mm  | 1 SB111M-23 |
| 24 mm  | 1 SB111M-24 |
| 25 mm  | 1 SB111M-25 |
| 26 mm  | 1 SB111M-26 |
| 27 mm  | 1 SB111M-27 |
| 28 mm  | 1 SB111M-28 |
| 29 mm  | 1 SB111M-29 |
| 30 mm  | 1 SB111M-30 |
| 32 mm  | 1 SB111M-32 |

**Imperial Stubby Combination Wrenches with Chrome Finish**





**1Z**

|    |             |
|---|-------------|
| 3/16 in   | 20 1Z-3/16  |
| 7/32 in   | 20 1Z-7/32  |
| 9/32 in   | 20 1Z-9/32  |
| 5/16 in   | 10 1Z-5/16  |
| 11/32 in  | 10 1Z-11/32 |
| 3/8 in  | 10 1Z-3/8   |
| 7/16 in   | 10 1Z-7/16  |
| 1/2 in  | 10 1Z-1/2   |
| 9/16 in   | 10 1Z-9/16  |
| 5/8 in  | 10 1Z-5/8   |
| 11/16 in  | 10 1Z-11/16 |
| 3/4 in  | 10 1Z-3/4   |
| 13/16 in  | 10 1Z-13/16 |
| 7/8 in  | 5 1Z-7/8    |
| 15/16 in  | 5 1Z-15/16  |
| 1 in  | 10 1Z-1     |

**Imperial Flat Combination Wrenches with Chrome Finish**





**111Z**

|    |                |
|--|----------------|
| 1/4 in   | 5 111Z-1/4     |
| 5/16 in  | 5 111Z-5/16    |
| 3/8 in   | 5 111Z-3/8     |
| 7/16 in  | 5 111Z-7/16    |
| 1/2 in   | 5 111Z-1/2     |
| 9/16 in  | 5 111Z-9/16    |
| 5/8 in   | 5 111Z-5/8     |
| 11/16 in   | 5 111Z-11/16   |
| 3/4 in   | 5 111Z-3/4     |
| 13/16 in   | 5 111Z-13/16   |
| 7/8 in   | 5 111Z-7/8     |
| 15/16 in   | 3 111Z-15/16   |
| 1 in   | 3 111Z-1       |
| 1 1/16 in  | 5 111Z-1.1/16  |
| 1 1/8 in   | 5 111Z-1.1/8   |
| 1 1/4 in   | 5 111Z-1.1/4   |
| 1 5/16 in  | 5 111Z-1.5/16  |
| 1 3/8 in   | 1 111Z-1.3/8   |
| 1 7/16 in  | 1 111Z-1.7/16  |
| 1 1/2 in   | 1 111Z-1.1/2   |
| 1 5/8 in   | 1 111Z-1.5/8   |
| 1 11/16 in   | 1 111Z-1.11/16 |
| 1 3/4 in   | 1 111Z-1.3/4   |
| 1 13/16 in   | 1 111Z-1.13/16 |
| 1 7/8 in   | 1 111Z-1.7/8   |
| 2 in   | 1 111Z-2       |
| 2 1/8 in   | 1 111Z-2.1/8   |
| 2 1/4 in   | 1 111Z-2.1/4   |
| 2 3/8 in   | 1 111Z-2.3/8   |
| 2 1/2 in   | 1 111Z-2.1/2   |
| 2 5/8 in   | 1 111Z-2.5/8   |
| 2 3/4 in   | 1 111Z-2.3/4   |
| 2 7/8 in   | 1 111Z-2.7/8   |
| 3 in   | 1 111Z-3       |

**Metric Flat Combination Wrenches with Matte Finish**



**S20**

|    |            |
|---|------------|
| 9   | 1 SBS20-9  |
| 12  | 1 SBS20-12 |
| 15  | 1 SBS20-15 |
| 16  | 1 SBS20-16 |
| 20  | 1 SBS20-20 |

**Metric Flat Combination Wrench Set - 5 Pcs/Plastic Holder**



**111M/SH5**

|    |            |
|---|------------|
| 5   | 1 111M/SH5 |

111M-8, 111M-10, 111M-13, 111M-17, 111M-19

**Metric Flat Combination Wrench Set - 8 Pcs/Plastic Holder**



**111M/SH8**

|    |            |
|---|------------|
| 8   | 1 111M/SH8 |

111M-8, 111M-10, 111M-12, 111M-13, 111M-14, 111M-17, 111M-19, 111M-22

**Metric Flat Combination Wrench Set 9-18 mm - 12 Pcs/Plastic Holder**



**111M/SH12**

|    |             |
|---|-------------|
| 12  | 1 111M/SH12 |

111M-8, 111M-9, 111M-10, 111M-11, 111M-12, 111M-13, 111M-14, 111M-15, 111M-16, 111M-17, 111M-18, 111M-19





Metric Flat Combination Wrench Set  
Cardboard Box



**111M/**



10

1 111M/S10

111M-8, 111M-9, 111M-10, 111M-11,  
111M-12, 111M-13, 111M-14, 111M-17,  
111M-19, 111M-22



Metric Flat Combination Wrench Set - 11  
Pcs/Pouch



**111M/11T**



11

1 111M/11T

111M-8, 111M-9, 111M-10, 111M-11,  
111M-12, 111M-13, 111M-14, 111M-15,  
111M-17, 111M-19, 111M-22



Metric Flat Combination Wrench Set - 14  
Pcs/Pouch



**111M/14T**



14

1 111M/14T

111M-6, 111M-8, 111M-9, 111M-10,  
111M-13, 111M-14, 111M-15, 111M-17,  
111M-19, 111M-22, 111M-24, 111M-27,  
111M-30, 111M-32



Metric Flat Combination Wrench Set 6-22  
mm - 17 Pcs/Pouch



**111M/17T**



17

1 111M/17T

111M-6, 111M-7, 111M-8, 111M-9,  
111M-10, 111M-11, 111M-12, 111M-13,  
111M-14, 111M-15, 111M-16, 111M-17,  
111M-18, 111M-19, 111M-20, 111M-21,  
111M-22



Metric Flat Combination Wrench Set 8-32  
mm - 17 Pcs/Pouch



**111M/17TL**



17

1 111M/17TL

111M-8, 111M-9, 111M-10, 111M-11,  
111M-12, 111M-13, 111M-14, 111M-15,  
111M-16, 111M-18, 111M-19, 111M-22,  
111M-24, 111M-26, 111M-27, 111M-30,  
111M-32



Metric Flat Combination Wrench Set - 24  
Pcs/Pouch



**111M/24T**



24

1 111M/24T

111M-6, 111M-7, 111M-8, 111M-9,  
111M-10, 111M-11, 111M-12, 111M-13,  
111M-14, 111M-15, 111M-16, 111M-17,  
111M-18, 111M-19, 111M-20, 111M-21,  
111M-22, 111M-24, 111M-26, 111M-27,  
111M-28, 111M-30, 111M-32, 111M-36



Metric Flat Combination Wrench Set - 26  
Pcs/Pouch



**111M/26T**



26

1 111M/26T

111M-6, 111M-7, 111M-8, 111M-9, 111M-10,  
111M-11, 111M-12, 111M-13, 111M-14, 111M-15,  
111M-16, 111M-17, 111M-18, 111M-19, 111M-20,  
111M-21, 111M-22, 111M-23, 111M-24, 111M-25,  
111M-26, 111M-27, 111M-28, 111M-29, 111M-30,  
111M-32



Imperial Flat Combination Wrench Set - 8  
Pcs/Black Plastic Pouch



**111Z/**



8

1 111Z/8T

111Z-3/8, 111Z-7/16, 111Z-1/2, 111Z-9/16, 111Z-5/8, 111Z-11/16, 111Z-3/4, 111Z-7/8



Imperial Flat Combination Wrench Set - 11 Pcs/Black Plastic Pouch



111Z/11T



11

1 111Z/11T

111Z-3/8, 111Z-7/16, 111Z-1/2, 111Z-9/16, 111Z-5/8, 111Z-11/16, 111Z-3/4, 111Z-13/16, 111Z-7/8, 111Z-15/16, 111Z-1



Metric Long Type Combination Wrenches with Chrome Finish



11M



|       |   |        |
|-------|---|--------|
| 8 mm  | 5 | 11M-8  |
| 9 mm  | 5 | 11M-9  |
| 10 mm | 5 | 11M-10 |
| 11 mm | 5 | 11M-11 |
| 12 mm | 5 | 11M-12 |
| 13 mm | 5 | 11M-13 |
| 14 mm | 5 | 11M-14 |
| 15 mm | 5 | 11M-15 |
| 16 mm | 5 | 11M-16 |
| 17 mm | 5 | 11M-17 |
| 18 mm | 5 | 11M-18 |
| 19 mm | 5 | 11M-19 |
| 21 mm | 5 | 11M-21 |
| 22 mm | 5 | 11M-22 |
| 24 mm | 5 | 11M-24 |
| 27 mm | 1 | 11M-27 |
| 30 mm | 1 | 11M-30 |
| 32 mm | 1 | 11M-32 |
| 36 mm | 1 | 11M-36 |
| 38 mm | 1 | 11M-38 |

Imperial Long Type Combination Wrenches with Chrome Finish



11Z



|          |   |           |
|----------|---|-----------|
| 3/8 in   | 5 | 11Z-3/8   |
| 7/16 in  | 5 | 11Z-7/16  |
| 1/2 in   | 5 | 11Z-1/2   |
| 9/16 in  | 5 | 11Z-9/16  |
| 5/8 in   | 5 | 11Z-5/8   |
| 11/16 in | 5 | 11Z-11/16 |
| 3/4 in   | 5 | 11Z-3/4   |
| 13/16 in | 5 | 11Z-13/16 |
| 1 in     | 5 | 11Z-1     |

Metric Lilliput Combination Wrenches with Chrome Finish



4020L-M



|        |   |             |
|--------|---|-------------|
| 3.2 mm | 5 | 4020L-M-3.2 |
| 3.5 mm | 5 | 4020L-M-3.5 |
| 4 mm   | 5 | 4020L-M-4   |
| 4.5 mm | 5 | 4020L-M-4.5 |
| 5 mm   | 5 | 4020L-M-5   |
| 5.5 mm | 5 | 4020L-M-5.5 |

Metric Offset Combination Wrenches with Chrome Finish



1952M



|       |    |          |
|-------|----|----------|
| 6 mm  | 10 | 1952M-6  |
| 7 mm  | 10 | 1952M-7  |
| 8 mm  | 10 | 1952M-8  |
| 9 mm  | 10 | 1952M-9  |
| 10 mm | 10 | 1952M-10 |
| 11 mm | 10 | 1952M-11 |
| 12 mm | 10 | 1952M-12 |
| 13 mm | 10 | 1952M-13 |
| 14 mm | 10 | 1952M-14 |
| 15 mm | 10 | 1952M-15 |



|       |    |            |
|-------|----|------------|
| 16 mm | 10 | 1952M-16   |
| 17 mm | 10 | 1952M-17   |
| 18 mm | 10 | 1952M-18   |
| 19 mm | 10 | 1952M-19   |
| 20 mm | 10 | 1952M-20   |
| 21 mm | 10 | 1952M-21   |
| 22 mm | 5  | 1952M-22   |
| 23 mm | 5  | 1952M-23   |
| 24 mm | 5  | 1952M-24   |
| 25 mm | 5  | 1952M-25   |
| 26 mm | 5  | 1952M-26   |
| 27 mm | 5  | 1952M-27   |
| 28 mm | 1  | 1952M-28   |
| 29 mm | 1  | 1952M-29   |
| 30 mm | 1  | 1952M-30   |
| 32 mm | 1  | 1952M-32   |
| 34 mm | 1  | 1952M-34   |
| 36 mm | 1  | 1952M-36   |
| 41 mm | 1  | 1952M-41   |
| 46 mm | 1  | 1952M-46   |
| 50 mm | 1  | 1952M-50   |
| 55 mm | 1  | 1952M-55   |
| 60 mm | 1  | 1952M-60   |
| 65 mm | 1  | 1952M-65   |
| 70 mm | 1  | 1952M-70   |
| 75 mm | 1  | 1952M-75   |
| 80 mm | 1  | 1952M-80   |
| 7 mm  | 1  | SB1952M-7  |
| 8 mm  | 1  | SB1952M-8  |
| 10 mm | 1  | SB1952M-10 |
| 12 mm | 1  | SB1952M-12 |
| 13 mm | 1  | SB1952M-13 |
| 14 mm | 1  | SB1952M-14 |
| 17 mm | 1  | SB1952M-17 |
| 19 mm | 1  | SB1952M-19 |
| 24 mm | 1  | SB1952M-24 |

Imperial Offset Combination Wrenches with Chrome Finish



1952Z



|           |   |              |
|-----------|---|--------------|
| 1/4 in    | 5 | 1952Z-1/4    |
| 5/16 in   | 5 | 1952Z-5/16   |
| 11/32 in  | 5 | 1952Z-11/32  |
| 3/8 in    | 5 | 1952Z-3/8    |
| 7/16 in   | 5 | 1952Z-7/16   |
| 1/2 in    | 5 | 1952Z-1/2    |
| 9/16 in   | 5 | 1952Z-9/16   |
| 5/8 in    | 5 | 1952Z-5/8    |
| 11/16 in  | 5 | 1952Z-11/16  |
| 3/4 in    | 5 | 1952Z-3/4    |
| 13/16 in  | 5 | 1952Z-13/16  |
| 7/8 in    | 5 | 1952Z-7/8    |
| 15/16 in  | 5 | 1952Z-15/16  |
| 1 in      | 1 | 1952Z-1      |
| 1 1/16 in | 1 | 1952Z-1.1/16 |
| 1 1/8 in  | 1 | 1952Z-1.1/8  |
| 1 1/4 in  | 1 | 1952Z-1.1/4  |
| 1 5/16 in | 1 | 1952Z-1.5/16 |
| 1 3/8 in  | 1 | 1952Z-1.3/8  |
| 1 7/16 in | 1 | 1952Z-1.7/16 |
| 1 1/2 in  | 1 | 1952Z-1.1/2  |
| 1 5/8 in  | 1 | 1952Z-1.5/8  |



Metric Offset Combination Wrenches with 12-Point Dynamic-Drive™



**PU**



|       |         |
|-------|---------|
| 6 mm  | 5 PU-6  |
| 9 mm  | 5 PU-9  |
| 14 mm | 5 PU-14 |
| 20 mm | 3 PU-20 |
| 22 mm | 3 PU-22 |
| 24 mm | 3 PU-24 |

Metric Offset Combination Wrench Set - 10 Pcs/Box



**1952M/**



|    |            |
|----|------------|
| 10 | 1 1952M/10 |
|----|------------|

1952M-8, 1952M-9, 1952M-10, 1952M-11, 1952M-12, 1952M-13, 1952M-14, 1952M-16, 1952M-17, 1952M-19

Metric Offset Combination Wrench Set - 17 Pcs/Pouch



**1952M/17T**



|    |             |
|----|-------------|
| 17 | 1 1952M/17T |
|----|-------------|

1952M-6, 1952M-7, 1952M-8, 1952M-9, 1952M-10, 1952M-11, 1952M-12, 1952M-13, 1952M-14, 1952M-15, 1952M-16, 1952M-17, 1952M-18, 1952M-19, 1952M-20, 1952M-21, 1952M-22

Metric Offset Combination Ratcheting Wrench Set - 8 Pcs



**1952M/SH**



|   |             |
|---|-------------|
| 6 | 1 1952M/SH6 |
|---|-------------|

1952M-8, 1952M-10, 1952M-12, 1952M-13, 1952M-14, 1952M-17

Metric Offset Combination Wrench Set - 7 Pcs/Pouch



**1952M/T**



|   |            |
|---|------------|
| 7 | 1 1952M/7T |
|---|------------|

1952M-8, 1952M-10, 1952M-13, 1952M-14, 1952M-17, 1952M-19, 1952M-22

Metric Offset Combination Wrench Set - 26 Pcs/Pouch



**1952M/26T**



|    |             |
|----|-------------|
| 26 | 1 1952M/26T |
|----|-------------|

1952M-6, 1952M-7, 1952M-8, 1952M-9, 1952M-10, 1952M-11, 1952M-12, 1952M-13, 1952M-14, 1952M-15, 1952M-16, 1952M-17, 1952M-18, 1952M-19, 1952M-20, 1952M-21, 1952M-22, 1952M-23, 1952M-24, 1952M-25, 1952M-26, 1952M-27, 1952M-28, 1952M-29, 1952M-30, 1952M-32

Metric Offset Combination Ratcheting Wrench Set - 12 Pcs



**1952M/SH12**



|    |              |
|----|--------------|
| 12 | 1 1952M/SH12 |
|----|--------------|

1952M-8, 1952M-9, 1952M-10, 1952M-11, 1952M-12, 1952M-13, 1952M-14, 1952M-15, 1952M-16, 1952M-17, 1952M-18, 1952M-19

Metric Offset Combination Wrench Set - 14 Pcs/Pouch



**1952M/14T**



|    |             |
|----|-------------|
| 14 | 1 1952M/14T |
|----|-------------|

1952M-6, 1952M-8, 1952M-9, 1952M-10, 1952M-13, 1952M-14, 1952M-15, 1952M-17, 1952M-19, 1952M-22, 1952M-24, 1952M-27, 1952M-30, 1952M-32

### Imperial Offset Combination Wrench Set



#### 1952Z/T



11 1 1952Z/11T

1952Z-1/4, 1952Z-5/16, 1952Z-3/8,  
1952Z-7/16, 1952Z-1/2, 1952Z-9/16,  
1952Z-5/8, 1952Z-11/16, 1952Z-3/4,  
1952Z-13/16, 1952Z-7/8



## RATCHETING WRENCHES

### Metric Combination Ratcheting Wrenches with Chrome Finish



#### 1RM



|       |   |        |
|-------|---|--------|
| 6 mm  | 1 | 1RM-6  |
| 7 mm  | 1 | 1RM-7  |
| 8 mm  | 1 | 1RM-8  |
| 9 mm  | 1 | 1RM-9  |
| 10 mm | 1 | 1RM-10 |
| 11 mm | 1 | 1RM-11 |
| 12 mm | 1 | 1RM-12 |
| 13 mm | 1 | 1RM-13 |
| 14 mm | 1 | 1RM-14 |
| 15 mm | 1 | 1RM-15 |
| 16 mm | 1 | 1RM-16 |
| 17 mm | 1 | 1RM-17 |
| 18 mm | 1 | 1RM-18 |
| 19 mm | 1 | 1RM-19 |
| 21 mm | 1 | 1RM-21 |
| 22 mm | 1 | 1RM-22 |
| 24 mm | 1 | 1RM-24 |
| 27 mm | 1 | 1RM-27 |
| 30 mm | 1 | 1RM-30 |
| 32 mm | 1 | 1RM-32 |

### Imperial Combination Ratcheting Wrenches with Chrome Finish



#### 1RZ



|          |   |           |
|----------|---|-----------|
| 1/4 in   | 1 | 1RZ-1/4   |
| 5/16 in  | 1 | 1RZ-5/16  |
| 11/32 in | 1 | 1RZ-11/32 |
| 3/8 in   | 1 | 1RZ-3/8   |
| 7/16 in  | 1 | 1RZ-7/16  |
| 1/2 in   | 1 | 1RZ-1/2   |
| 9/16 in  | 1 | 1RZ-9/16  |
| 5/8 in   | 1 | 1RZ-5/8   |
| 11/16 in | 1 | 1RZ-11/16 |
| 3/4 in   | 1 | 1RZ-3/4   |
| 7/8 in   | 1 | 1RZ-7/8   |
| 15/16 in | 1 | 1RZ-15/16 |

### Metric Stubby Combination Ratcheting Wrenches with Chrome Finish



#### 10RM



|       |   |         |
|-------|---|---------|
| 8 mm  | 1 | 10RM-8  |
| 10 mm | 1 | 10RM-10 |
| 13 mm | 1 | 10RM-13 |
| 14 mm | 1 | 10RM-14 |
| 17 mm | 1 | 10RM-17 |
| 19 mm | 1 | 10RM-19 |

### Imperial Stubby Combination Ratcheting Wrenches with Chrome Finish



#### 10RZ



|         |   |           |
|---------|---|-----------|
| 5/16 in | 1 | 10RZ-5/16 |
| 3/8 in  | 1 | 10RZ-3/8  |
| 7/16 in | 1 | 10RZ-7/16 |



|          |   |            |
|----------|---|------------|
| 1/2 in   | 1 | 10RZ-1/2   |
| 9/16 in  | 1 | 10RZ-9/16  |
| 5/8 in   | 1 | 10RZ-5/8   |
| 11/16 in | 1 | 10RZ-11/16 |
| 3/4 in   | 1 | 10RZ-3/4   |

### Metric Swivel Head Combination Ratcheting Wrenches with Chrome Finish



#### 41RM



|       |   |         |
|-------|---|---------|
| 8 mm  | 1 | 41RM-8  |
| 10 mm | 1 | 41RM-10 |
| 11 mm | 1 | 41RM-11 |
| 12 mm | 1 | 41RM-12 |
| 13 mm | 1 | 41RM-13 |
| 14 mm | 1 | 41RM-14 |
| 17 mm | 1 | 41RM-17 |
| 19 mm | 1 | 41RM-19 |
| 21 mm | 1 | 41RM-21 |

### Imperial Swivel Head Combination Ratcheting Wrenches with Chrome Finish



#### 41RZ



|          |   |            |
|----------|---|------------|
| 5/16 in  | 1 | 41RZ-5/16  |
| 3/8 in   | 1 | 41RZ-3/8   |
| 7/16 in  | 1 | 41RZ-7/16  |
| 1/2 in   | 1 | 41RZ-1/2   |
| 9/16 in  | 1 | 41RZ-9/16  |
| 5/8 in   | 1 | 41RZ-5/8   |
| 11/16 in | 1 | 41RZ-11/16 |
| 3/4 in   | 1 | 41RZ-3/4   |
| 13/16 in | 1 | 41RZ-13/16 |
| 7/8 in   | 1 | 41RZ-7/8   |





Metric Combination Ratcheting Wrench Set - 6 Pcs/Plastic Holder



**1RM/**



6

1 1RM/SH6

1RM-8, 1RM-10, 1RM-12, 1RM-13, 1RM-14, 1RM-17



Metric Combination Ratcheting Wrench Set - 5 Pcs/Plastic Box



**1RM/S5**



5

10 1RM/S5

1RM-8, 1RM-10, 1RM-13, 1RM-17, 1RM-19



Stubby Combination Ratcheting Wrench Set



**10RM/**



6

1 10RM/SH6

10RM-8, 10RM-10, 10RM-13, 10RM-14, 10RM-17, 10RM-19



Metric Combination Ratcheting Wrench Set - 8 Pcs/Plastic Holder



**1RM/SH8**



8

1 1RM/SH8

1RM-8, 1RM-10, 1RM-11, 1RM-12, 1RM-13, 1RM-14, 1RM-17, 1RM-19



Imperial Combination Ratcheting Wrench Set Plastic Holder



**1RZ/**



8

1 1RZ/SH8

1RZ-5/16, 1RZ-3/8, 1RZ-7/16, 1RZ-1/2, 1RZ-9/16, 1RZ-5/8, 1RZ-11/16, 1RZ-3/4



Metric Swivel Head Combination Ratcheting Wrench Set Plastic Holder



**41RM/SH8**



8

10 41RM/SH8

41RM-8, 41RM-10, 41RM-11, 41RM-12, 41RM-13, 41RM-14, 41RM-17, 41RM-19



Metric Combination Ratcheting Wrench Set - 12 Pcs/Plastic Holder



**1RM/SH12**



12

10 1RM/SH12

1RM-8, 1RM-9, 1RM-10, 1RM-11, 1RM-12, 1RM-13, 1RM-14, 1RM-15, 1RM-16, 1RM-17, 1RM-18, 1RM-19



Combination Ratcheting Wrench and Adaptors Set



**1RMA/S8**



160 x 283 x 75 mm

1 1RMA/S8

1RMA-13-3/8-SQ, 1RMA-10-1/4-SQ, 1RMA-19-1/2-SQ



1RMA-13-5/16-BIT, 1RMA-10-1/4-BIT



1RM-13, 1RM-10, 1RM-19



Ratcheting Adjustable Ring Wrench Set



**42RM/S12**



229 x 70 x 280 mm

1562 g

1 42RM/S12

Metric Ratcheting Ring Wrenches with Chrome Finish



**1320RM**

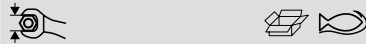

|          |   |              |
|----------|---|--------------|
| 6-7 mm   | 1 | 1320RM-6-7   |
| 8-9 mm   | 1 | 1320RM-8-9   |
| 10-11 mm | 1 | 1320RM-10-11 |
| 12-13 mm | 1 | 1320RM-12-13 |
| 14-15 mm | 1 | 1320RM-14-15 |
| 16-17 mm | 1 | 1320RM-16-17 |
| 17-19 mm | 1 | 1320RM-17-19 |
| 18-19 mm | 1 | 1320RM-18-19 |
| 22-24 mm | 1 | 1320RM-22-24 |

S Type Ratcheting Ring Wrenches with Chrome Finish



**1320SRM**

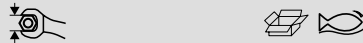

|          |   |               |
|----------|---|---------------|
| 14-19 mm | 1 | 1320SRM-14-19 |
|----------|---|---------------|

**1320SRM-14-19**

1RMA-19-17-HEX, 1RMA-19-16-HEX, 1RMA-19-15-HEX, 1RMA-19-13-HEX, 1RMA-19-9/16-HEX, 1RMA-19-5/8-HEX, 1RMA-19-11/16-HEX, 1RMA-19-1/2-HEX, 1RMA-19-E18-TX, 1RMA-19-E20-TX, 1RMA-19-E16-TX, 1RMA-19-E22-TX, 1RMA-19-1/2-SQ2, 1RMA-14-11-HEX, 1RMA-14-12-HEX, 1RMA-14-E11-TX, 1RMA-14-E12-TX, 1RMA-14-E10-TX, 1RMA-14-E14-TX, 1RMA-14-E8-TX, 1RMA-14-10-HEX, 1RMA-14-7/16-HEX, 1RMA-14-3/8-HEX, 1RMA-14-5/16-HEX, 1RMA-14-8-HEX, 1RMA-14-9-HEX

1RMA-19-1/4-SQ

SBS19-TH22

Imperial Ratcheting Ring Wrenches with Chrome Finish



**1320RZ**



|               |    |                   |
|---------------|----|-------------------|
| 1/4-5/16" in  | 1  | 1320RZ-1/4-5/16   |
| 5/16-11/32 in | 60 | 1320RZ-5/16-11/32 |
| 3/8-7/16" in  | 1  | 1320RZ-3/8-7/16   |
| 1/2-9/16" in  | 1  | 1320RZ-1/2-9/16   |
| 5/8-11/16" in | 1  | 1320RZ-5/8-11/16  |
| 3/4-13/16" in | 1  | 1320RZ-3/4-13/16  |
| 3/4-7/8" in   | 1  | 1320RZ-3/4-7/8    |
| 7/8-15/16" in | 1  | 1320RZ-7/8-15/16  |

Metric Ratcheting Ring Wrench Set



**1320RM/**

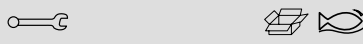

|   |   |            |
|---|---|------------|
| 8 | 1 | 1320RM/SH8 |
|---|---|------------|

1320RM-6-7, 1320RM-8-9, 1320RM-10-11, 1320RM-12-13, 1320RM-14-15, 1320RM-16-17, 1320RM-18-19, 1320RM-22-24

Imperial Angled Head Ratcheting Ring Wrenches with Chrome Finish



**1321RZ**



|              |   |                  |
|--------------|---|------------------|
| 3/8-7/16 in  | 1 | 1321RZ-3/8-7/16  |
| 1/2-9/16 in  | 1 | 1321RZ-1/2-9/16  |
| 5/8-11/16 in | 1 | 1321RZ-5/8-11/16 |
| 3/4x7/8 in   | 1 | 1321RZ-3/4-7/8   |

S Type Ratcheting Ring Wrench and Adaptor Set



**1320SRM/**



|    |   |             |
|----|---|-------------|
| 29 | 1 | 1320SRM/S29 |
|----|---|-------------|

4-in-1 Ratcheting Ring Wrenches with Chrome Finish



**S4RM**

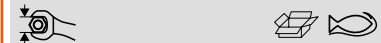

|                |   |            |
|----------------|---|------------|
| 4x5 6x7 mm     | 1 | S4RM-4-7   |
| 8x9 10x11 mm   | 1 | S4RM-8-11  |
| 12x13 14x15 mm | 1 | S4RM-12-15 |
| 16x17 18x19 mm | 1 | S4RM-16-19 |
| 20x21 24x27 mm | 1 | S4RM-21-27 |
| 30x32 34x36 mm | 1 | S4RM-30-36 |

4-in-1 Ratcheting Ring Wrench Set - 3 Pcs/Pouch



**S4RM/**

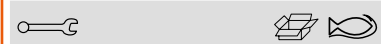

|   |    |         |
|---|----|---------|
| 3 | 20 | S4RM/3T |
|---|----|---------|

S4RM-8-11, S4RM-12-15, S4RM-16-19





4-in-1 Ratcheting Ring Wrench Set - 4 Pcs/Pouch



**S4RM/4T**



4 1 S4RM/4T

S4RM-8-11, S4RM-12-15, S4RM-16-19, S4RM-21-27



4-in-1 Ratcheting Ring Wrench Set - 5 Pcs/Pouch



**S4RM/5T**



5 1 S4RM/5T

S4RM-8-11, S4RM-12-15, S4RM-16-19, S4RM-21-27, S4RM-30-36



Drive Socket and Bit Adaptors for Ratcheting Wrenches



**1RMA-SQ**



|        |       |   |                |
|--------|-------|---|----------------|
| 1/4 in | 10 mm | 1 | 1RMA-10-1/4-SQ |
| 3/8 in | 13 mm | 1 | 1RMA-13-3/8-SQ |
| 1/2 in | 19 mm | 1 | 1RMA-19-1/2-SQ |
| 1/4 in | 19 mm | 1 | 1RMA-19-1/4-SQ |

Ratcheting Wrenches Adaptors for 1/4" and 5/16" Bits



**1RMA-BIT**



|      |       |   |                  |
|------|-------|---|------------------|
| 1/4  | 10 mm | 1 | 1RMA-10-1/4-BIT  |
| 5/16 | 13 mm | 1 | 1RMA-13-5/16-BIT |
| 10   | 13 mm | 1 | 1RMA-13-10-BIT   |

Ratcheting Wrench Adaptor Set



**1RMA/S4**



84 x 100 x 35 mm 1 1RMA/S4

1RMA-10-1/4-SQ, 1RMA-19-1/2-SQ, 1RMA-13-3/8-SQ



1RMA-10-1/4-BIT



**OPEN END WRENCHES**

Metric Double Open End Wrenches with Chrome Finish



**6M**

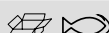

|            |    |            |
|------------|----|------------|
| 4x5 mm     | 10 | 6M-4-5     |
| 4.5x5.5 mm | 10 | 6M-4.5-5.5 |
| 5x5.5 mm   | 10 | 6M-5-5.5   |

| 5.5x7 mm | 10 | 6M-5.5-7   |
|----------|----|------------|
| 6x7 mm   | 10 | 6M-6-7     |
| 7x8 mm   | 10 | 6M-7-8     |
| 8x9 mm   | 10 | 6M-8-9     |
| 8x10 mm  | 10 | 6M-8-10    |
| 10x11 mm | 10 | 6M-10-11   |
| 10x13 mm | 10 | 6M-10-13   |
| 12x13 mm | 10 | 6M-12-13   |
| 12x14 mm | 10 | 6M-12-14   |
| 13x14 mm | 10 | 6M-13-14   |
| 13x15 mm | 10 | 6M-13-15   |
| 13x16 mm | 10 | 6M-13-16   |
| 13x17 mm | 10 | 6M-13-17   |
| 14x15 mm | 10 | 6M-14-15   |
| 14x17 mm | 10 | 6M-14-17   |
| 16x17 mm | 10 | 6M-16-17   |
| 16x18 mm | 10 | 6M-16-18   |
| 17x19 mm | 10 | 6M-17-19   |
| 18x19 mm | 10 | 6M-18-19   |
| 19x22 mm | 10 | 6M-19-22   |
| 19x24 mm | 10 | 6M-19-24   |
| 20x22 mm | 10 | 6M-20-22   |
| 21x23 mm | 10 | 6M-21-23   |
| 21x24 mm | 10 | 6M-21-24   |
| 22x24 mm | 10 | 6M-22-24   |
| 24x26 mm | 10 | 6M-24-26   |
| 24x27 mm | 10 | 6M-24-27   |
| 24x30 mm | 5  | 6M-24-30   |
| 25x28 mm | 5  | 6M-25-28   |
| 27x29 mm | 5  | 6M-27-29   |
| 27x30 mm | 5  | 6M-27-30   |
| 27x32 mm | 5  | 6M-27-32   |
| 30x32 mm | 5  | 6M-30-32   |
| 30x36 mm | 5  | 6M-30-36   |
| 32x36 mm | 5  | 6M-32-36   |
| 34x36 mm | 1  | 6M-34-36   |
| 36x41 mm | 1  | 6M-36-41   |
| 38x42 mm | 1  | 6M-38-42   |
| 41x46 mm | 1  | 6M-41-46   |
| 46x50 mm | 1  | 6M-46-50   |
| 4x5 mm   | 1  | SB6M-4-5   |
| 6x7 mm   | 1  | SB6M-6-7   |
| 8x9 mm   | 1  | SB6M-8-9   |
| 10x11 mm | 1  | SB6M-10-11 |
| 12x13 mm | 1  | SB6M-12-13 |
| 14x15 mm | 1  | SB6M-14-15 |
| 16x17 mm | 1  | SB6M-16-17 |
| 17x19 mm | 1  | SB6M-17-19 |
| 18x19 mm | 1  | SB6M-18-19 |
| 20x22 mm | 1  | SB6M-20-22 |
| 21x23 mm | 1  | SB6M-21-23 |
| 22x24 mm | 1  | SB6M-22-24 |
| 24x26 mm | 1  | SB6M-24-26 |
| 24x27 mm | 1  | SB6M-24-27 |
| 25x28 mm | 1  | SB6M-25-28 |
| 27x29 mm | 1  | SB6M-27-29 |
| 30x32 mm | 1  | SB6M-30-32 |

Imperial Double Open End Wrenches with Chrome Finish



**6Z**

| Size            | Quantity | Part Number     |
|-----------------|----------|-----------------|
| 1/4x5/16 in     | 5        | 6Z-1/4-5/16     |
| 5/16x11/32 in   | 5        | 6Z-5/16-11/32   |
| 3/8x7/16 in     | 5        | 6Z-3/8-7/16     |
| 7/16x1/2 in     | 5        | 6Z-7/16-1/2     |
| 1/2x9/16 in     | 5        | 6Z-1/2-9/16     |
| 9/16x5/8 in     | 5        | 6Z-9/16-5/8     |
| 19/32x11/16 in  | 5        | 6Z-19/32-11/16  |
| 5/8x3/4 in      | 5        | 6Z-5/8-3/4      |
| 11/16x3/4 in    | 5        | 6Z-11/16-3/4    |
| 3/4x7/8 in      | 5        | 6Z-3/4-7/8      |
| 25/32x13/16 in  | 5        | 6Z-25/32-13/16  |
| 13/16x7/8 in    | 5        | 6Z-13/16-7/8    |
| 7/8x15/16 in    | 5        | 6Z-7/8-15/16    |
| 15/16x1 in      | 5        | 6Z-15/16-1      |
| 1x1.1/8 in      | 1        | 6Z-1-1.1/8      |
| 1.1/16x1.1/4 in | 1        | 6Z-1.1/16-1.1/4 |
| 1.1/4x1.3/8 in  | 1        | 6Z-1.1/4-1.3/8  |

Imperial Lilliput Double Open End Wrenches with Chrome Finish



**1931Z**

| Size         | Length | Quantity | Part Number     |
|--------------|--------|----------|-----------------|
| 1/8 in       | 74 mm  | 5        | 1931Z-1/8       |
| 5/32 in      | 80 mm  | 5        | 1931Z-5/32      |
| 3/16 in      | 80 mm  | 5        | 1931Z-3/16      |
| 13/64 in     | 80 mm  | 5        | 1931Z-13/64     |
| 7/32 in      | 80 mm  | 5        | 1931Z-7/32      |
| 15/64x1/4 in | 84 mm  | 5        | 1931Z-15/64-1/4 |
| 1/4 in       | 80 mm  | 5        | 1931Z-1/4       |
| 9/32 in      | 90 mm  | 5        | 1931Z-9/32      |
| 9/32x5/16 in | 94 mm  | 5        | 1931Z-9/32-5/16 |
| 5/16 in      | 90 mm  | 5        | 1931Z-5/16      |
| 11/32 in     | 105 mm | 5        | 1931Z-11/32     |
| 11/32x3/8 in | 94 mm  | 5        | 1931Z-11/32-3/8 |
| 3/8 in       | 105 mm | 5        | 1931Z-3/8       |
| 7/16 in      | 120 mm | 5        | 1931Z-7/16      |
| 1/2 in       | 120 mm | 5        | 1931Z-1/2       |
| 9/16 in      | 130 mm | 5        | 1931Z-9/16      |
| 5/8 in       | 130 mm | 5        | 1931Z-5/8       |

Metric Double Open End Wrench Set - 8 Pcs/Plastic Holder



**6M/SH**

| Quantity | Part Number |
|----------|-------------|
| 8        | 6M/SH8      |

6M-6-7, 6M-8-9, 6M-10-11, 6M-12-13, 6M-14-15, 6M-16-17, 6M-18-19, 6M-20-22

Metric Double Open End Wrench Set - 12 Pcs/Plastic Holder



**6M/SH12**

| Quantity | Part Number |
|----------|-------------|
| 12       | 6M/SH12     |

6M-6-7, 6M-8-9, 6M-10-11, 6M-12-13, 6M-14-15, 6M-16-17, 6M-18-19, 6M-20-22, 6M-21-23, 6M-24-26, 6M-25-28, 6M-30-32

Metric Lilliput Double Open End Wrenches with Chrome Finish



**1931M**

| Size   | Quantity | Part Number |
|--------|----------|-------------|
| 4 mm   | 5        | 1931M-4     |
| 4.5 mm | 5        | 1931M-4.5   |
| 5 mm   | 5        | 1931M-5     |
| 5.5 mm | 5        | 1931M-5.5   |
| 6 mm   | 5        | 1931M-6     |
| 7 mm   | 5        | 1931M-7     |
| 8 mm   | 5        | 1931M-8     |
| 9 mm   | 5        | 1931M-9     |
| 10 mm  | 5        | 1931M-10    |
| 11 mm  | 5        | 1931M-11    |
| 12 mm  | 5        | 1931M-12    |
| 13 mm  | 5        | 1931M-13    |
| 14 mm  | 5        | 1931M-14    |
| 17 mm  | 5        | 1931M-17    |

Metric Double Open End Wrenches with Phosphate Finish



**895M**

| Size     | Length | Quantity | Part Number |
|----------|--------|----------|-------------|
| 6x7 mm   | 96 mm  | 10       | 895M-6-7    |
| 8x9 mm   | 109 mm | 10       | 895M-8-9    |
| 8x10 mm  | 115 mm | 10       | 895M-8-10   |
| 10x11 mm | 124 mm | 10       | 895M-10-11  |
| 10x13 mm | 110 mm | 10       | 895M-10-13  |
| 13x17 mm | 155 mm | 10       | 895M-13-17  |
| 17x19 mm | 172 mm | 10       | 895M-17-19  |
| 19x22 mm | 195 mm | 10       | 895M-19-22  |
| 19x24 mm | 206 mm | 5        | 895M-19-24  |
| 22x24 mm | 220 mm | 5        | 895M-22-24  |
| 24x27 mm | 244 mm | 5        | 895M-24-27  |
| 24x30 mm | 265 mm | 5        | 895M-24-30  |
| 27x32 mm | 270 mm | 5        | 895M-27-32  |
| 30x32 mm | 275 mm | 5        | 895M-30-32  |
| 30x36 mm | 305 mm | 1        | 895M-30-36  |
| 32x36 mm | 307 mm | 1        | 895M-32-36  |
| 36x41 mm | 345 mm | 1        | 895M-36-41  |
| 41x46 mm | 381 mm | 1        | 895M-41-46  |
| 46x50 mm | 420 mm | 1        | 895M-46-50  |
| 50x55 mm | 460 mm | 1        | 895M-50-55  |
| 55x60 mm | 500 mm | 1        | 895M-55-60  |
| 65x70 mm | 580 mm | 1        | 895M-65-70  |

Metric Double Open End Wrench Set - 8 Pcs/Box



**6M/S**

| Quantity | Part Number |
|----------|-------------|
| 8        | 6M/S8       |

6M-6-7, 6M-8-9, 6M-10-11, 6M-12-13, 6M-14-15, 6M-16-17, 6M-18-19, 6M-20-22



Metric Double Open End Wrench Set - 6 Pcs/Plastic Clip



**6M/**



6

1 6M/6C

6M-6-7, 6M-8-9, 6M-10-11, 6M-12-13, 6M-14-15, 6M-16-17



Metric Double Open End Wrench Set - 12 Pcs/Plastic Clip



**6M/12C**



12

1 6M/12C

6M-6-7, 6M-8-9, 6M-10-11, 6M-12-13, 6M-14-15, 6M-16-17, 6M-18-19, 6M-20-22, 6M-21-23, 6M-24-27, 6M-25-28, 6M-30-32



Metric Double Open End Wrench Set - 8 Pcs/Plastic Clip



**6M/8C**



8

1 6M/8C

6M-6-7, 6M-8-9, 6M-10-11, 6M-12-13, 6M-14-15, 6M-16-17, 6M-18-19, 6M-20-22



Imperial Double Open End Wrench Set



**6Z/**



8

1 6Z/8C

6Z-1/4-5/16, 6Z-3/8-7/16, 6Z-5/16-11/32, 6Z-1/2-9/16, 6Z-19/32-11/16, 6Z-5/8-3/4, 6Z-13/16-7/8, 6Z-15/16-1



Metric Double Open End Wrench Set - 10 Pcs/Plastic Clip



**6M/10C**



10

1 6M/10C

6M-6-7, 6M-8-9, 6M-10-11, 6M-12-13, 6M-14-15, 6M-16-17, 6M-18-19, 6M-20-22, 6M-24-27, 6M-30-32



Metric Lilliput Double Open End Wrench Set



**1931M/**



10

1 1931M/10T

1931M-4, 1931M-4.5, 1931M-5, 1931M-5.5, 1931M-6, 1931M-7, 1931M-8, 1931M-9, 1931M-10, 1931M-11



Imperial Lilliput Double Open End Wrench Set



**1931Z/**



12

1 1931Z/12T

1931Z-5/32, 1931Z-9/32, 1931Z-5/16, 1931Z-11/32, 1931Z-3/8, 1931Z-3/16, 1931Z-7/32, 1931Z-1/4, 1931Z-7/16, 1931Z-1/2, 1931Z-5/8, 1931Z-9/16



Metric Electronic Double Open End Wrench Set



**1933M/**



6

1 1933M/6T

4x4, 4.5x4.5, 5x5, 5.5x5.5, 6x6, 7x7

Metric Double Open End Magneto Wrench Set on Ring



**3280M/**



8

1 3280M

4, 4.5, 5, 5.5, 6, 6.5, 7, 7.5 mm

### 1/4" Square Drive Crowfoot Open End Wrenches



#### 677-

| Icon 1 | Icon 2 | Icon 3 | Icon 4  |
|--------|--------|--------|---------|
| 7 mm   | 1/4 in | 1      | 677-7   |
| 8 mm   | 1/4 in | 1      | 677-8   |
| 9 mm   | 1/4 in | 1      | 677-9   |
| 10 mm  | 1/4 in | 1      | 677-10  |
| 13 mm  | 1/4 in | 1      | 677-13  |
| 3/8 in | 1/4 in | 1      | 677-3/8 |

### 3/8" Square Drive Crowfoot Open End Wrenches



#### 747-

| Icon 1 | Icon 2 | Icon 3 | Icon 4 |
|--------|--------|--------|--------|
| 10 mm  | 3/8 in | 1      | 747-10 |
| 11 mm  | 3/8 in | 1      | 747-11 |
| 12 mm  | 3/8 in | 1      | 747-12 |
| 13 mm  | 3/8 in | 1      | 747-13 |
| 14 mm  | 3/8 in | 1      | 747-14 |
| 15 mm  | 3/8 in | 1      | 747-15 |
| 16 mm  | 3/8 in | 1      | 747-16 |
| 17 mm  | 3/8 in | 1      | 747-17 |
| 18 mm  | 3/8 in | 1      | 747-18 |
| 19 mm  | 3/8 in | 1      | 747-19 |
| 20 mm  | 3/8 in | 1      | 747-20 |
| 21 mm  | 3/8 in | 1      | 747-21 |
| 22 mm  | 3/8 in | 1      | 747-22 |
| 23 mm  | 3/8 in | 1      | 747-23 |
| 24 mm  | 3/8 in | 1      | 747-24 |
| 25 mm  | 3/8 in | 1      | 747-25 |
| 26 mm  | 3/8 in | 1      | 747-26 |
| 27 mm  | 3/8 in | 1      | 747-27 |
| 28 mm  | 3/8 in | 1      | 747-28 |
| 30 mm  | 3/8 in | 1      | 747-30 |
| 32 mm  | 3/8 in | 1      | 747-32 |
| 34 mm  | 3/8 in | 1      | 747-34 |
| 36 mm  | 3/8 in | 1      | 747-36 |
| 40 mm  | 3/8 in | 1      | 747-40 |
| 41 mm  | 3/8 in | 1      | 747-41 |
| 42 mm  | 3/8 in | 1      | 747-42 |
| 46 mm  | 3/8 in | 1      | 747-46 |

| Icon 1     | Icon 2 | Icon 3 | Icon 4      |
|------------|--------|--------|-------------|
| 50 mm      | 3/8 in | 1      | 747-50      |
| 3/8 in     | 3/8 in | 1      | 747-3/8     |
| 7/16 in    | 3/8 in | 1      | 747-7/16    |
| 1/2 in     | 3/8 in | 1      | 747-1/2     |
| 9/16 in    | 3/8 in | 1      | 747-9/16    |
| 5/8 in     | 3/8 in | 1      | 747-5/8     |
| 11/16 in   | 3/8 in | 1      | 747-11/16   |
| 3/4 in     | 3/8 in | 1      | 747-3/4     |
| 13/16 in   | 3/8 in | 1      | 747-13/16   |
| 7/8 in     | 3/8 in | 1      | 747-7/8     |
| 15/16 in   | 3/8 in | 1      | 747-15/16   |
| 1 in       | 3/8 in | 1      | 747-1       |
| 1.1/16 in  | 3/8 in | 1      | 747-1.1/16  |
| 1.1/8 in   | 3/8 in | 1      | 747-1.1/8   |
| 1.3/16 in  | 3/8 in | 1      | 747-1.3/16  |
| 1.1/4 in   | 3/8 in | 1      | 747-1.1/4   |
| 1.5/16 in  | 3/8 in | 1      | 747-1.5/16  |
| 1.3/8 in   | 3/8 in | 1      | 747-1.3/8   |
| 1.7/16 in  | 3/8 in | 1      | 747-1.7/16  |
| 1.1/2 in   | 3/8 in | 1      | 747-1.1/2   |
| 1.9/16 in  | 3/8 in | 1      | 747-1.9/16  |
| 1.5/8 in   | 3/8 in | 1      | 747-1.5/8   |
| 1.11/16 in | 3/8 in | 1      | 747-1.11/16 |
| 1.3/4 in   | 3/8 in | 1      | 747-1.3/4   |
| 1.13/16 in | 3/8 in | 1      | 747-1.13/16 |
| 1.7/8 in   | 3/8 in | 1      | 747-1.7/8   |
| 1.15/16 in | 3/8 in | 1      | 747-1.15/16 |
| 2 in       | 3/8 in | 1      | 747-2       |
| 2.1/16 in  | 3/8 in | 1      | 747-2.1/16  |
| 2.1/8 in   | 3/8 in | 1      | 747-2.1/8   |
| 2.3/16 in  | 3/8 in | 1      | 747-2.3/16  |
| 2.1/4 in   | 3/8 in | 1      | 747-2.1/4   |
| 2.5/16 in  | 3/8 in | 1      | 747-2.5/16  |
| 2.3/8 in   | 3/8 in | 1      | 747-2.3/8   |
| 2.7/16 in  | 3/8 in | 1      | 747-2.7/16  |
| 2.1/2 in   | 3/8 in | 1      | 747-2.1/2   |
| 2.9/16 in  | 3/8 in | 1      | 747-2.9/16  |
| 2.5/8 in   | 3/8 in | 1      | 747-2.5/8   |
| 2.3/4 in   | 3/8 in | 1      | 747-2.3/4   |
| 2.7/8 in   | 3/8 in | 1      | 747-2.7/8   |

### 1/2" Square Drive Crowfoot Open End Wrenches



#### 787-

| Icon 1     | Icon 2 | Icon 3 | Icon 4      |
|------------|--------|--------|-------------|
| 1.1/16 in  | 1/2 in | 1      | 787-1.1/16  |
| 1.1/8 in   | 1/2 in | 1      | 787-1.1/8   |
| 1.3/16 in  | 1/2 in | 1      | 787-1.3/16  |
| 1.1/4 in   | 1/2 in | 1      | 787-1.1/4   |
| 1.5/16 in  | 1/2 in | 1      | 787-1.5/16  |
| 1.3/8 in   | 1/2 in | 1      | 787-1.3/8   |
| 1.7/16 in  | 1/2 in | 1      | 787-1.7/16  |
| 1.1/2 in   | 1/2 in | 1      | 787-1.1/2   |
| 1.5/8 in   | 1/2 in | 1      | 787-1.5/8   |
| 1.11/16 in | 1/2 in | 1      | 787-1.11/16 |
| 1.3/4 in   | 1/2 in | 1      | 787-1.3/4   |

| Icon 1     | Icon 2 | Icon 3 | Icon 4      |
|------------|--------|--------|-------------|
| 1.13/16 in | 1/2 in | 1      | 787-1.13/16 |
| 1.7/8 in   | 1/2 in | 1      | 787-1.7/8   |
| 2 in       | 1/2 in | 1      | 787-2       |
| 2.1/8 in   | 1/2 in | 1      | 787-2.1/8   |
| 2.3/16 in  | 1/2 in | 1      | 787-2.3/16  |
| 2.1/4 in   | 1/2 in | 1      | 787-2.1/4   |
| 2.3/8 in   | 1/2 in | 1      | 787-2.3/8   |

### Metric Single Open End Wrenches with Phosphate Finish



#### 894M

| Icon 1 | Icon 2  | Icon 3 | Icon 4   |
|--------|---------|--------|----------|
| 7 mm   | 78 mm   | 10     | 894M-7   |
| 8 mm   | 94 mm   | 10     | 894M-8   |
| 9 mm   | 100 mm  | 10     | 894M-9   |
| 10 mm  | 106 mm  | 10     | 894M-10  |
| 11 mm  | 112 mm  | 10     | 894M-11  |
| 12 mm  | 125 mm  | 10     | 894M-12  |
| 13 mm  | 125 mm  | 10     | 894M-13  |
| 14 mm  | 140 mm  | 10     | 894M-14  |
| 15 mm  | 140 mm  | 10     | 894M-15  |
| 16 mm  | 140 mm  | 10     | 894M-16  |
| 17 mm  | 158 mm  | 10     | 894M-17  |
| 19 mm  | 171 mm  | 10     | 894M-19  |
| 21 mm  | 195 mm  | 5      | 894M-21  |
| 22 mm  | 195 mm  | 5      | 894M-22  |
| 24 mm  | 216 mm  | 5      | 894M-24  |
| 27 mm  | 240 mm  | 5      | 894M-27  |
| 30 mm  | 262 mm  | 5      | 894M-30  |
| 32 mm  | 274 mm  | 5      | 894M-32  |
| 34 mm  | 274 mm  | 1      | 894M-34  |
| 36 mm  | 303 mm  | 5      | 894M-36  |
| 38 mm  | 305 mm  | 1      | 894M-38  |
| 41 mm  | 343 mm  | 1      | 894M-41  |
| 46 mm  | 378 mm  | 1      | 894M-46  |
| 50 mm  | 413 mm  | 1      | 894M-50  |
| 55 mm  | 457 mm  | 1      | 894M-55  |
| 60 mm  | 492 mm  | 1      | 894M-60  |
| 65 mm  | 528 mm  | 1      | 894M-65  |
| 70 mm  | 573 mm  | 1      | 894M-70  |
| 75 mm  | 608 mm  | 1      | 894M-75  |
| 80 mm  | 644 mm  | 1      | 894M-80  |
| 85 mm  | 690 mm  | 1      | 894M-85  |
| 90 mm  | 690 mm  | 1      | 894M-90  |
| 95 mm  | 850 mm  | 1      | 894M-95  |
| 100 mm | 1000 mm | 1      | 894M-100 |
| 105 mm | 1000 mm | 1      | 894M-105 |
| 110 mm | 1000 mm | 1      | 894M-110 |
| 115 mm | 1000 mm | 1      | 894M-115 |
| 120 mm | 1000 mm | 1      | 894M-120 |
| 125 mm | 1000 mm | 1      | 894M-125 |
| 130 mm | 1000 mm | 1      | 894M-130 |
| 135 mm | 1000 mm | 1      | 894M-135 |





Metric Scaffolding Open End Wrench with Phosphate finish



| Size     | Length (mm) | Quantity | Part No. |
|----------|-------------|----------|----------|
| 30x32 mm | 362 mm      | 5        | 2M-30-32 |
| 32x36 mm | 402 mm      | 1        | 2M-32-36 |
| 36x41 mm | 438 mm      | 1        | 2M-36-41 |
| 41x46 mm | 485 mm      | 1        | 2M-41-46 |
| 46x50 mm | 535 mm      | 1        | 2M-46-50 |

SC335M

| Size  | Length (mm) | Quantity | Part No.  |
|-------|-------------|----------|-----------|
| 17 mm | 320 mm      | 1        | SC335M-17 |
| 19 mm | 350 mm      | 1        | SC335M-19 |
| 22 mm | 350 mm      | 1        | SC335M-22 |
| 24 mm | 370 mm      | 1        | SC335M-24 |
| 27 mm | 370 mm      | 1        | SC335M-27 |
| 30 mm | 400 mm      | 1        | SC335M-30 |
| 32 mm | 400 mm      | 1        | SC335M-32 |
| 36 mm | 430 mm      | 1        | SC335M-36 |
| 41 mm | 470 mm      | 1        | SC335M-41 |
| 46 mm | 500 mm      | 1        | SC335M-46 |

RING END WRENCHES

Metric Deep Offset Double Ring End Wrenches with Chrome Finish



2M

| Size     | Length (mm) | Quantity | Part No. |
|----------|-------------|----------|----------|
| 6x7 mm   | 165 mm      | 5        | 2M-6-7   |
| 8x9 mm   | 180 mm      | 5        | 2M-8-9   |
| 8x10 mm  | 180 mm      | 5        | 2M-8-10  |
| 10x11 mm | 190 mm      | 5        | 2M-10-11 |
| 10x13 mm | 190 mm      | 5        | 2M-10-13 |
| 12x13 mm | 210 mm      | 5        | 2M-12-13 |
| 13x17 mm | 243 mm      | 5        | 2M-13-17 |
| 14x15 mm | 226 mm      | 5        | 2M-14-15 |
| 16x17 mm | 246 mm      | 5        | 2M-16-17 |
| 16x18 mm | 246 mm      | 5        | 2M-16-18 |
| 17x19 mm | 266 mm      | 5        | 2M-17-19 |
| 18x19 mm | 266 mm      | 5        | 2M-18-19 |
| 19x22 mm | 291 mm      | 5        | 2M-19-22 |
| 20x22 mm | 291 mm      | 5        | 2M-20-22 |
| 21x23 mm | 306 mm      | 5        | 2M-21-23 |
| 22x24 mm | 306 mm      | 5        | 2M-22-24 |
| 24x26 mm | 326 mm      | 5        | 2M-24-26 |
| 24x27 mm | 326 mm      | 5        | 2M-24-27 |
| 25x28 mm | 336 mm      | 5        | 2M-25-28 |
| 27x29 mm | 351 mm      | 5        | 2M-27-29 |
| 27x30 mm | 351 mm      | 5        | 2M-27-30 |
| 27x32 mm | 353 mm      | 5        | 2M-27-32 |

Imperial Deep Offset Double Ring End Wrenches with Chrome Finish



ZZ

| Size            | Length (mm) | Quantity | Part No.        |
|-----------------|-------------|----------|-----------------|
| 1/4x5/16 in     | 165 mm      | 1        | ZZ-1/4-5/16     |
| 5/16x3/8 in     | 180 mm      | 1        | ZZ-5/16-3/8     |
| 3/8x7/16 in     | 190 mm      | 1        | ZZ-3/8-7/16     |
| 1/2x9/16 in     | 210 mm      | 1        | ZZ-1/2-9/16     |
| 9/16x5/8 in     | 225.8 mm    | 1        | ZZ-9/16-5/8     |
| 5/8x11/16 in    | 245.5 mm    | 1        | ZZ-5/8-11/16    |
| 3/4x7/8 in      | 290.5 mm    | 1        | ZZ-3/4-7/8      |
| 13/16x7/8 in    | 290.5 mm    | 1        | ZZ-13/16-7/8    |
| 15/16x1 in      | 325.8 mm    | 1        | ZZ-15/16-1      |
| 1x1 1/8 in      | 335.9 mm    | 1        | ZZ-1-1.1/8      |
| 1 1/16x1 1/4 in | 353 mm      | 1        | ZZ-1.1/16-1.1/4 |

Imperial Offset Double Ring End Wrenches with Chrome Finish



1300Z

| Size           | Length (mm) | Quantity | Part No.          |
|----------------|-------------|----------|-------------------|
| 1/4x5/16 in    | 156 mm      | 1        | 1300Z-1/4-5/16    |
| 3/8x7/16 in    | 193 mm      | 1        | 1300Z-3/8-7/16    |
| 1/2x9/16 in    | 220 mm      | 1        | 1300Z-1/2-9/16    |
| 19/32x11/16 in | 258 mm      | 1        | 1300Z-19/32-11/16 |
| 5/8x3/4 in     | 278 mm      | 1        | 1300Z-5/8-3/4     |
| 25/32x13/16 in | 300 mm      | 1        | 1300Z-25/32-13/16 |
| 7/8x15/16 in   | 334 mm      | 1        | 1300Z-7/8-15/16   |
| 15/16x1 in     | 352 mm      | 1        | 1300Z-15/16-1     |
| 1x1 1/8 in     | 380 mm      | 1        | 1300Z-1-1.1/8     |

Metric Deep Offset Double Ring End Wrench Set - 8 Pcs/Box



2M/S

| Quantity | Part No. |
|----------|----------|
| 8        | 1 2M/S8  |

2M-6-7, 2M-8-9, 2M-10-11, 2M-12-13, 2M-14-15, 2M-16-17, 2M-18-19, 2M-20-22

Metric Deep Offset Double Ring End Wrench Set - 8 Pcs/Pouch



2M/T

| Quantity | Part No. |
|----------|----------|
| 8        | 1 2M/T8  |

2M-6-7, 2M-8-9, 2M-10-11, 2M-12-13, 2M-14-15, 2M-16-17, 2M-18-19, 2M-20-22

Metric Deep Offset Double Ring End Wrench Set - 10 Pcs/Pouch



2M/10T

| Quantity | Part No. |
|----------|----------|
| 10       | 1 2M/10T |

2M-6-7, 2M-8-9, 2M-10-11, 2M-12-13, 2M-14-15, 2M-16-17, 2M-18-19, 2M-20-22, 2M-21-23, 2M-24-27

Metric Deep Offset Double Ring End Wrench Set - 12 Pcs/Pouch



**2M/12T**

|    |   |        |
|----|---|--------|
|    |   |        |
| 12 | 1 | 2M/12T |

2M-6-7, 2M-8-9, 2M-10-11, 2M-12-13, 2M-14-15, 2M-16-17, 2M-18-19, 2M-20-22, 2M-21-23, 2M-24-27, 2M-25-28, 2M-30-32

Imperial Deep Offset Double Ring End Wrench Set Black Plastic Pouch



**2Z/T**

|   |   |      |
|---|---|------|
|   |   |      |
| 7 | 1 | 2Z/T |

2Z-1/4-5/16, 2Z-5/16-3/8, 2Z-3/8-7/16, 2Z-1/2-9/16, 2Z-9/16-5/8, 2Z-5/8-11/16, 2Z-3/4-7/8

Flat Double Ring End Wrenches with Chrome Finish



**4M**

|          |        |    |          |
|----------|--------|----|----------|
|          |        |    |          |
| 6x7 mm   | 95 mm  | 10 | 4M-6-7   |
| 8x 9 mm  | 110 mm | 10 | 4M-8-9   |
| 10x11 mm | 125 mm | 10 | 4M-10-11 |

|          |        |    |          |
|----------|--------|----|----------|
|          |        |    |          |
| 12x13 mm | 140 mm | 10 | 4M-12-13 |
| 14x15 mm | 155 mm | 10 | 4M-14-15 |
| 16x17 mm | 170 mm | 10 | 4M-16-17 |
| 17x19 mm | 170 mm | 10 | 4M-17-19 |
| 18x19 mm | 185 mm | 10 | 4M-18-19 |
| 20x22 mm | 205 mm | 10 | 4M-20-22 |
| 21x23 mm | 225 mm | 5  | 4M-21-23 |
| 24x26 mm | 250 mm | 1  | 4M-24-26 |
| 24x27 mm | 255 mm | 1  | 4M-24-27 |
| 25x28 mm | 275 mm | 1  | 4M-25-28 |
| 27x29 mm | 275 mm | 1  | 4M-27-29 |
| 30x32 mm | 300 mm | 1  | 4M-30-32 |

Imperial Long Type Double Ring End Wrenches



**44Z**

|                |        |    |                 |
|----------------|--------|----|-----------------|
|                |        |    |                 |
| 1/4x5/16 in    | 197 mm | 10 | 44Z-1/4-5/16    |
| 5/16x3/8 in    | 238 mm | 10 | 44Z-5/16-3/8    |
| 3/8x7/16 in    | 284 mm | 10 | 44Z-3/8-7/16    |
| 7/16x1/2 in    | 326 mm | 10 | 44Z-7/16-1/2    |
| 1/2x9/16 in    | 358 mm | 10 | 44Z-1/2-9/16    |
| 5/8x3/4 in     | 401 mm | 5  | 44Z-5/8-3/4     |
| 11/16x3/4 in   | 401 mm | 5  | 44Z-11/16-3/4   |
| 11/16x13/16 in | 410 mm | 5  | 44Z-11/16-13/16 |

Metric Starter and Manifold Flat Half Moon Box Wrenches with Double Ring End



**1943M**

|          |        |   |             |
|----------|--------|---|-------------|
|          |        |   |             |
| 11x13 mm | 150 mm | 1 | 1943M-11-13 |
| 13x15 mm | 185 mm | 1 | 1943M-13-15 |
| 13x17 mm | 185 mm | 1 | 1943M-13-17 |
| 14x17 mm | 185 mm | 1 | 1943M-14-17 |
| 15x17 mm | 185 mm | 1 | 1943M-15-17 |
| 19x22 mm | 235 mm | 1 | 1943M-19-22 |

Imperial Starter and Manifold Flat Half Moon Box Wrenches with Double Ring End



**1943Z**

|                |        |   |                   |
|----------------|--------|---|-------------------|
|                |        |   |                   |
| 5/16x3/8 in    | 153 mm | 1 | 1943Z-5/16-3/8    |
| 7/16x1/2 in    | 153 mm | 1 | 1943Z-7/16-1/2    |
| 9/16x5/8 in    | 186 mm | 1 | 1943Z-9/16-5/8    |
| 5/8x3/4 in     | 233 mm | 1 | 1943Z-5/8-3/4     |
| 11/16x13/16 in | 233 mm | 1 | 1943Z-11/16-13/16 |

Metric Flat Double Ring End Wrench Set Black Plastic Pouch



**4M/T**

|    |   |        |
|----|---|--------|
|    |   |        |
| 10 | 1 | 4M/10T |

4M-6-7, 4M-8-9, 4M-10-11, 4M-12-13, 4M-14-15, 4M-16-17, 4M-18-19, 4M-20-22, 4M-24-27, 4M-30-32

Metric Flat Double Ring End Wrench Set Grey Plastic Clip Pack



**4M/C**

|    |   |        |
|----|---|--------|
|    |   |        |
| 10 | 1 | 4M/10C |

4M-6-7, 4M-8-9, 4M-10-11, 4M-12-13, 4M-14-15, 4M-16-17, 4M-18-19, 4M-20-22, 4M-21-23, 4M-24-27





Metric Flat Double Ring End Wrench Set



4M/12C

|    |   |        |
|----|---|--------|
|    |   |        |
| 12 | 1 | 4M/12C |

4M-6-7, 4M-8-9, 4M-10-11, 4M-12-13, 4M-14-15, 4M-16-17, 4M-18-19, 4M-20-22, 4M-21-23, 4M-24-27, 4M-25-28, 4M-30-32

Metric Flat Double Ring End Wrench Set Standard Cardboard Box



4M/

|   |   |      |
|---|---|------|
|   |   |      |
| 8 | 1 | 4M/8 |

4M-6-7, 4M-8-9, 4M-10-11, 4M-12-13, 4M-14-15, 4M-16-17, 4M-18-19, 4M-20-22

FLARE NUT WRENCHES

Metric Double End Offset Flare Nut Wrenches with Chrome Finish



1949M

|          |        |   |             |
|----------|--------|---|-------------|
|          |        |   |             |
| 8x 9 mm  | 140 mm | 1 | 1949M-8-9   |
| 10x11 mm | 150 mm | 1 | 1949M-10-11 |
| 10x12 mm | 150 mm | 1 | 1949M-10-12 |

|          |        |   |             |
|----------|--------|---|-------------|
|          |        |   |             |
| 12x13 mm | 170 mm | 1 | 1949M-12-13 |
| 12x14 mm | 170 mm | 1 | 1949M-12-14 |
| 14x15 mm | 170 mm | 1 | 1949M-14-15 |
| 14x17 mm | 200 mm | 1 | 1949M-14-17 |
| 17x19 mm | 210 mm | 1 | 1949M-17-19 |
| 19x22 mm | 220 mm | 1 | 1949M-19-22 |
| 22x24 mm | 235 mm | 1 | 1949M-22-24 |
| 24x27 mm | 255 mm | 1 | 1949M-24-27 |
| 30x32 mm | 280 mm | 1 | 1949M-30-32 |

Imperial Double End Offset Flare Nut Wrenches with Chrome Finish



1949Z

|             |        |   |                |
|-------------|--------|---|----------------|
|             |        |   |                |
| 3/8x7/16 in | 150 mm | 1 | 1949Z-3/8-7/16 |
| 1/2x9/16 in | 170 mm | 1 | 1949Z-1/2-9/16 |
| 5/8x3/4 in  | 210 mm | 1 | 1949Z-5/8-3/4  |
| 3/4x7/8 in  | 220 mm | 1 | 1949Z-3/4-7/8  |
| 1x1 1/8 in  | 255 mm | 1 | 1949Z-1-1.1/8  |

1/4" Square Drive Flare Nut Crowfoot Wrenches



679-

|         |        |   |          |
|---------|--------|---|----------|
|         |        |   |          |
| 7 mm    | 1/4 in | 1 | 679-7    |
| 8 mm    | 1/4 in | 1 | 679-8    |
| 9 mm    | 1/4 in | 1 | 679-9    |
| 10 mm   | 1/4 in | 1 | 679-10   |
| 11 mm   | 1/4 in | 1 | 679-11   |
| 12 mm   | 1/4 in | 1 | 679-12   |
| 13 mm   | 1/4 in | 1 | 679-13   |
| 14 mm   | 1/4 in | 1 | 679-14   |
| 3/8 in  | 1/4 in | 1 | 679-3/8  |
| 7/16 in | 1/4 in | 1 | 679-7/16 |
| 1/2 in  | 1/4 in | 1 | 679-1/2  |
| 9/16 in | 1/4 in | 1 | 679-9/16 |

3/8" Square Drive Flare Nut Crowfoot Wrenches



749-

|            |        |    |             |
|------------|--------|----|-------------|
|            |        |    |             |
| 10 mm      | 3/8 in | 10 | 749-10      |
| 11 mm      | 3/8 in | 10 | 749-11      |
| 13 mm      | 3/8 in | 10 | 749-13      |
| 14 mm      | 3/8 in | 10 | 749-14      |
| 15 mm      | 3/8 in | 1  | 749-15      |
| 16 mm      | 3/8 in | 1  | 749-16      |
| 17 mm      | 3/8 in | 1  | 749-17      |
| 18 mm      | 3/8 in | 1  | 749-18      |
| 19 mm      | 3/8 in | 1  | 749-19      |
| 20 mm      | 3/8 in | 1  | 749-20      |
| 21 mm      | 3/8 in | 1  | 749-21      |
| 22 mm      | 3/8 in | 1  | 749-22      |
| 23 mm      | 3/8 in | 1  | 749-23      |
| 24 mm      | 3/8 in | 1  | 749-24      |
| 25 mm      | 3/8 in | 1  | 749-25      |
| 26 mm      | 3/8 in | 1  | 749-26      |
| 27 mm      | 3/8 in | 1  | 749-27      |
| 3/8 in     | 3/8 in | 1  | 749-3/8     |
| 7/16 in    | 3/8 in | 1  | 749-7/16    |
| 1/2 in     | 3/8 in | 1  | 749-1/2     |
| 9/16 in    | 3/8 in | 1  | 749-9/16    |
| 5/8 in     | 3/8 in | 1  | 749-5/8     |
| 11/16 in   | 3/8 in | 1  | 749-11/16   |
| 3/4 in     | 3/8 in | 1  | 749-3/4     |
| 13/16 in   | 3/8 in | 1  | 749-13/16   |
| 7/8 in     | 3/8 in | 1  | 749-7/8     |
| 15/16 in   | 3/8 in | 1  | 749-15/16   |
| 1 in       | 3/8 in | 1  | 749-1       |
| 1.1/16 in  | 3/8 in | 1  | 749-1.1/16  |
| 1.1/8 in   | 3/8 in | 1  | 749-1.1/8   |
| 1.3/16 in  | 3/8 in | 1  | 749-1.3/16  |
| 1.1/4 in   | 3/8 in | 1  | 749-1.1/4   |
| 1.5/16 in  | 3/8 in | 1  | 749-1.5/16  |
| 1.3/8 in   | 3/8 in | 1  | 749-1.3/8   |
| 1.7/16 in  | 3/8 in | 1  | 749-1.7/16  |
| 1.1/2 in   | 3/8 in | 1  | 749-1.1/2   |
| 1.9/16 in  | 3/8 in | 1  | 749-1.9/16  |
| 1.5/8 in   | 3/8 in | 1  | 749-1.5/8   |
| 1.11/16 in | 3/8 in | 1  | 749-1.11/16 |
| 1.3/4 in   | 3/8 in | 1  | 749-1.3/4   |
| 1.13/16 in | 3/8 in | 1  | 749-1.13/16 |
| 1.7/8 in   | 3/8 in | 1  | 749-1.7/8   |
| 1.15/16 in | 3/8 in | 1  | 749-1.15/16 |
| 2 in       | 3/8 in | 1  | 749-2       |
| 2.1/8 in   | 3/8 in | 1  | 749-2.1/8   |
| 2.3/16 in  | 3/8 in | 1  | 749-2.3/16  |
| 2.1/4 in   | 3/8 in | 1  | 749-2.1/4   |
| 2.3/8 in   | 3/8 in | 1  | 749-2.3/8   |
| 2.5/8 in   | 3/8 in | 1  | 749-2.5/8   |
| 2.3/4 in   | 3/8 in | 1  | 749-2.3/4   |
| 3.1/8 in   | 3/8 in | 1  | 749-3.1/8   |

### 1/2" Square Drive Flare Nut Crowfoot Wrenches



#### 789-

| Size       | Size   | Quantity | Part Number |
|------------|--------|----------|-------------|
| 28 mm      | 1/2 in | 1        | 789-28      |
| 30 mm      | 1/2 in | 1        | 789-30      |
| 32 mm      | 1/2 in | 1        | 789-32      |
| 34 mm      | 1/2 in | 1        | 789-34      |
| 36 mm      | 1/2 in | 1        | 789-36      |
| 38 mm      | 1/2 in | 1        | 789-38      |
| 40 mm      | 1/2 in | 1        | 789-40      |
| 41 mm      | 1/2 in | 1        | 789-41      |
| 42 mm      | 1/2 in | 1        | 789-42      |
| 46 mm      | 1/2 in | 1        | 789-46      |
| 50 mm      | 1/2 in | 1        | 789-50      |
| 1.1/8 in   | 1/2 in | 1        | 789-1.1/8   |
| 1.1/4 in   | 1/2 in | 1        | 789-1.1/4   |
| 1.5/16 in  | 1/2 in | 1        | 789-1.5/16  |
| 1.3/8 in   | 1/2 in | 1        | 789-1.3/8   |
| 1.7/16 in  | 1/2 in | 1        | 789-1.7/16  |
| 1.1/2 in   | 1/2 in | 1        | 789-1.1/2   |
| 1.9/16 in  | 1/2 in | 1        | 789-1.9/16  |
| 1.5/8 in   | 1/2 in | 1        | 789-1.5/8   |
| 1.3/4 in   | 1/2 in | 1        | 789-1.3/4   |
| 1.13/16 in | 1/2 in | 1        | 789-1.13/16 |
| 2 in       | 1/2 in | 1        | 789-2       |
| 2.1/4 in   | 1/2 in | 1        | 789-2.1/4   |
| 2.5/16 in  | 1/2 in | 1        | 789-2.5/16  |
| 2.3/8 in   | 1/2 in | 1        | 789-2.3/8   |

### 3/8" Square Drive Crowfoot Adjustable Wrenches



#### 1950MZ

| Size            | Quantity | Part Number |
|-----------------|----------|-------------|
| 0-29/0-1.1/8 in | 1        | 1950MZ-3/8  |

## SLOGGING WRENCHES

### Metric Ring End Slogging Wrenches



#### 7444SG-M

| Size   | Quantity | Part Number  |
|--------|----------|--------------|
| 24 mm  | 1        | 7444SG-M-24  |
| 27 mm  | 1        | 7444SG-M-27  |
| 30 mm  | 1        | 7444SG-M-30  |
| 32 mm  | 1        | 7444SG-M-32  |
| 34 mm  | 1        | 7444SG-M-34  |
| 36 mm  | 1        | 7444SG-M-36  |
| 38 mm  | 1        | 7444SG-M-38  |
| 41 mm  | 1        | 7444SG-M-41  |
| 42 mm  | 1        | 7444SG-M-42  |
| 46 mm  | 1        | 7444SG-M-46  |
| 50 mm  | 1        | 7444SG-M-50  |
| 55 mm  | 1        | 7444SG-M-55  |
| 60 mm  | 1        | 7444SG-M-60  |
| 65 mm  | 1        | 7444SG-M-65  |
| 70 mm  | 1        | 7444SG-M-70  |
| 75 mm  | 1        | 7444SG-M-75  |
| 80 mm  | 1        | 7444SG-M-80  |
| 85 mm  | 1        | 7444SG-M-85  |
| 90 mm  | 1        | 7444SG-M-90  |
| 95 mm  | 1        | 7444SG-M-95  |
| 100 mm | 1        | 7444SG-M-100 |
| 105 mm | 1        | 7444SG-M-105 |
| 110 mm | 1        | 7444SG-M-110 |
| 115 mm | 1        | 7444SG-M-115 |
| 120 mm | 1        | 7444SG-M-120 |
| 125 mm | 1        | 7444SG-M-125 |
| 130 mm | 1        | 7444SG-M-130 |
| 135 mm | 1        | 7444SG-M-135 |
| 140 mm | 1        | 7444SG-M-140 |
| 145 mm | 1        | 7444SG-M-145 |
| 150 mm | 1        | 7444SG-M-150 |
| 155 mm | 1        | 7444SG-M-155 |
| 160 mm | 1        | 7444SG-M-160 |
| 165 mm | 1        | 7444SG-M-165 |
| 170 mm | 1        | 7444SG-M-170 |
| 175 mm | 1        | 7444SG-M-175 |

### Imperial Ring End Slogging Wrenches



#### 7444SG-Z

| Size      | Quantity | Part Number     |
|-----------|----------|-----------------|
| 1 1/16 in | 1        | 7444SG-Z-1.1/16 |
| 1 1/8 in  | 1        | 7444SG-Z-1.1/8  |
| 1 3/16 in | 1        | 7444SG-Z-1.3/16 |

| Size       | Quantity | Part Number      |
|------------|----------|------------------|
| 1 1/4 in   | 1        | 7444SG-Z-1.1/4   |
| 1 5/16 in  | 1        | 7444SG-Z-1.5/16  |
| 1 3/8 in   | 1        | 7444SG-Z-1.3/8   |
| 1 7/16 in  | 1        | 7444SG-Z-1.7/16  |
| 1 1/2 in   | 1        | 7444SG-Z-1.1/2   |
| 1 5/8 in   | 1        | 7444SG-Z-1.5/8   |
| 1 11/16 in | 1        | 7444SG-Z-1.11/16 |
| 1 3/4 in   | 1        | 7444SG-Z-1.3/4   |
| 1 13/16 in | 1        | 7444SG-Z-1.13/16 |
| 1 7/8 in   | 1        | 7444SG-Z-1.7/8   |
| 2 in       | 1        | 7444SG-Z-2       |
| 2 1/16 in  | 1        | 7444SG-Z-2.1/16  |
| 2 1/8 in   | 1        | 7444SG-Z-2.1/8   |
| 2 3/16 in  | 1        | 7444SG-Z-2.3/16  |
| 2 1/4 in   | 1        | 7444SG-Z-2.1/4   |
| 2 3/8 in   | 1        | 7444SG-Z-2.3/8   |
| 2 9/16 in  | 1        | 7444SG-Z-2.9/16  |
| 2 5/8 in   | 1        | 7444SG-Z-2.5/8   |
| 2 3/4 in   | 1        | 7444SG-Z-2.3/4   |
| 3 in       | 1        | 7444SG-Z-3       |
| 3 1/8 in   | 1        | 7444SG-Z-3.1/8   |
| 3 3/8 in   | 1        | 7444SG-Z-3.3/8   |
| 3 1/2 in   | 1        | 7444SG-Z-3.1/2   |
| 3 3/4 in   | 1        | 7444SG-Z-3.3/4   |
| 3 7/8 in   | 1        | 7444SG-Z-3.7/8   |
| 4 in       | 1        | 7444SG-Z-4       |
| 4 1/8 in   | 1        | 7444SG-Z-4.1/8   |
| 4 1/2 in   | 1        | 7444SG-Z-4.1/2   |

### Metric Open End Slogging Wrenches



#### 133SGM

| Size   | Quantity | Part Number |
|--------|----------|-------------|
| 27 mm  | 1        | 133SGM-27   |
| 30 mm  | 1        | 133SGM-30   |
| 32 mm  | 1        | 133SGM-32   |
| 36 mm  | 1        | 133SGM-36   |
| 41 mm  | 1        | 133SGM-41   |
| 46 mm  | 1        | 133SGM-46   |
| 50 mm  | 1        | 133SGM-50   |
| 55 mm  | 1        | 133SGM-55   |
| 60 mm  | 1        | 133SGM-60   |
| 65 mm  | 1        | 133SGM-65   |
| 70 mm  | 1        | 133SGM-70   |
| 75 mm  | 1        | 133SGM-75   |
| 80 mm  | 1        | 133SGM-80   |
| 85 mm  | 1        | 133SGM-85   |
| 90 mm  | 1        | 133SGM-90   |
| 95 mm  | 1        | 133SGM-95   |
| 100 mm | 1        | 133SGM-100  |
| 105 mm | 1        | 133SGM-105  |
| 110 mm | 1        | 133SGM-110  |
| 115 mm | 1        | 133SGM-115  |
| 120 mm | 1        | 133SGM-120  |



### Metric Deep Offset Ring End Slogging Wrenches



#### 315M

| Size  | Quantity | Part Number |
|-------|----------|-------------|
| 27 mm | 1        | 315M-27     |
| 30 mm | 1        | 315M-30     |
| 32 mm | 1        | 315M-32     |
| 36 mm | 1        | 315M-36     |
| 41 mm | 1        | 315M-41     |
| 46 mm | 1        | 315M-46     |
| 50 mm | 1        | 315M-50     |
| 55 mm | 1        | 315M-55     |
| 60 mm | 1        | 315M-60     |
| 65 mm | 1        | 315M-65     |
| 70 mm | 1        | 315M-70     |
| 75 mm | 1        | 315M-75     |
| 80 mm | 1        | 315M-80     |

### Imperial Deep Offset Ring End Slogging Wrenches



#### 315Z

| Size       | Quantity | Part Number  |
|------------|----------|--------------|
| 1.1/16 in  | 1        | 315Z-1.1/16  |
| 1.1/8 in   | 1        | 315Z-1.1/8   |
| 1.3/16 in  | 1        | 315Z-1.3/16  |
| 1.1/4 in   | 1        | 315Z-1.1/4   |
| 1.5/16 in  | 1        | 315Z-1.5/16  |
| 1.3/8 in   | 1        | 315Z-1.3/8   |
| 1.7/16 in  | 1        | 315Z-1.7/16  |
| 1.1/2 in   | 1        | 315Z-1.1/2   |
| 1.5/8 in   | 1        | 315Z-1.5/8   |
| 1.11/16 in | 1        | 315Z-1.11/16 |
| 1.3/4 in   | 1        | 315Z-1.3/4   |
| 1.13/16 in | 1        | 315Z-1.13/16 |
| 1.7/8 in   | 1        | 315Z-1.7/8   |
| 1.15/16 in | 1        | 315Z-1.15/16 |
| 2 mm       | 1        | 315Z-2       |
| 2.1/16 in  | 1        | 315Z-2.1/16  |
| 2.1/8 in   | 1        | 315Z-2.1/8   |
| 2.3/16 in  | 1        | 315Z-2.3/16  |
| 2.1/4 in   | 1        | 315Z-2.1/4   |
| 2.5/16 in  | 1        | 315Z-2.5/16  |
| 2.3/8 in   | 1        | 315Z-2.3/8   |
| 2.1/2 in   | 1        | 315Z-2.1/2   |
| 2.9/16 in  | 1        | 315Z-2.9/16  |
| 2.5/8 in   | 1        | 315Z-2.5/8   |

| Size       | Quantity | Part Number  |
|------------|----------|--------------|
| 2.3/4 in   | 1        | 315Z-2.3/4   |
| 2.7/8 in   | 1        | 315Z-2.7/8   |
| 2.15/16 in | 1        | 315Z-2.15/16 |
| 3 mm       | 1        | 315Z-3       |
| 3.1/8 in   | 1        | 315Z-3.1/8   |

### Metric Deep Offset Heavy Duty Ring End Wrenches



#### 310M

| Size  | Quantity | Part Number |
|-------|----------|-------------|
| 24 mm | 1        | 310M-24     |
| 27 mm | 1        | 310M-27     |
| 30 mm | 1        | 310M-30     |
| 32 mm | 1        | 310M-32     |
| 36 mm | 1        | 310M-36     |
| 38 mm | 1        | 310M-38     |
| 41 mm | 1        | 310M-41     |
| 46 mm | 1        | 310M-46     |
| 50 mm | 1        | 310M-50     |
| 55 mm | 1        | 310M-55     |
| 60 mm | 1        | 310M-60     |
| 65 mm | 1        | 310M-65     |
| 70 mm | 1        | 310M-70     |
| 75 mm | 1        | 310M-75     |
| 80 mm | 1        | 310M-80     |
| 85 mm | 1        | 310M-85     |
| 90 mm | 1        | 310M-90     |
| 95 mm | 1        | 310M-95     |

### Extension Tubular Handles for 310M Ring Wrench



#### R310

| Size     | Quantity | Part Number |
|----------|----------|-------------|
| 24-30 mm | 1        | R310-0      |
| 32-41 mm | 1        | R310-1      |
| 46-55 mm | 1        | R310-2      |
| 60-95 mm | 1        | R310-3      |

## SOCKET WRENCHES

### Metric Double Head Offset Socket Wrenches with 12 x 6-Point Dynamic-Drive™



#### 28M

| Size  | Quantity | Part Number |
|-------|----------|-------------|
| 6 mm  | 5        | 28M-6       |
| 7 mm  | 5        | 28M-7       |
| 8 mm  | 5        | 28M-8       |
| 9 mm  | 5        | 28M-9       |
| 10 mm | 5        | 28M-10      |
| 11 mm | 5        | 28M-11      |
| 12 mm | 5        | 28M-12      |
| 13 mm | 5        | 28M-13      |
| 14 mm | 5        | 28M-14      |
| 15 mm | 5        | 28M-15      |
| 16 mm | 5        | 28M-16      |
| 17 mm | 5        | 28M-17      |
| 18 mm | 3        | 28M-18      |
| 19 mm | 3        | 28M-19      |
| 20 mm | 3        | 28M-20      |
| 21 mm | 3        | 28M-21      |
| 22 mm | 3        | 28M-22      |
| 23 mm | 3        | 28M-23      |
| 24 mm | 3        | 28M-24      |
| 25 mm | 3        | 28M-25      |
| 26 mm | 3        | 28M-26      |
| 27 mm | 3        | 28M-27      |
| 28 mm | 1        | 28M-28      |
| 29 mm | 1        | 28M-29      |
| 30 mm | 1        | 28M-30      |
| 32 mm | 1        | 28M-32      |
| 6 mm  | 10       | SB28M-6     |
| 7 mm  | 10       | SB28M-7     |
| 8 mm  | 10       | SB28M-8     |
| 9 mm  | 10       | SB28M-9     |
| 10 mm | 10       | SB28M-10    |
| 11 mm | 10       | SB28M-11    |
| 12 mm | 10       | SB28M-12    |
| 13 mm | 10       | SB28M-13    |
| 14 mm | 10       | SB28M-14    |
| 15 mm | 10       | SB28M-15    |
| 16 mm | 5        | SB28M-16    |
| 17 mm | 5        | SB28M-17    |
| 18 mm | 5        | SB28M-18    |
| 19 mm | 5        | SB28M-19    |
| 20 mm | 4        | SB28M-20    |
| 21 mm | 4        | SB28M-21    |
| 22 mm | 4        | SB28M-22    |
| 23 mm | 4        | SB28M-23    |
| 24 mm | 4        | SB28M-24    |

Metric Double Head Offset Socket Wrenches with 6 x 6-Point Dynamic-Drive™



**29M**



|       |   |        |
|-------|---|--------|
| 6 mm  | 5 | 29M-6  |
| 7 mm  | 5 | 29M-7  |
| 8 mm  | 5 | 29M-8  |
| 9 mm  | 5 | 29M-9  |
| 10 mm | 5 | 29M-10 |
| 11 mm | 5 | 29M-11 |
| 12 mm | 5 | 29M-12 |
| 13 mm | 5 | 29M-13 |
| 14 mm | 5 | 29M-14 |
| 15 mm | 5 | 29M-15 |
| 16 mm | 5 | 29M-16 |
| 17 mm | 5 | 29M-17 |
| 18 mm | 3 | 29M-18 |
| 19 mm | 3 | 29M-19 |
| 20 mm | 3 | 29M-20 |
| 21 mm | 3 | 29M-21 |
| 22 mm | 3 | 29M-22 |
| 23 mm | 3 | 29M-23 |
| 24 mm | 3 | 29M-24 |
| 25 mm | 3 | 29M-25 |
| 26 mm | 3 | 29M-26 |
| 27 mm | 3 | 29M-27 |
| 28 mm | 1 | 29M-28 |
| 29 mm | 1 | 29M-29 |
| 30 mm | 1 | 29M-30 |
| 32 mm | 1 | 29M-32 |

Metric Double Head Offset Socket Wrench Set with 12 x 6-Point Dynamic-Drive™ - 11 Pcs



**28M/11**



|    |   |        |
|----|---|--------|
| 11 | 1 | 28M/11 |
|----|---|--------|

28M-8, 28M-9, 28M-10, 28M-11, 28M-13, 28M-12, 28M-14, 28M-15, 28M-17, 28M-19, 28M-22

Metric Double Head Offset Socket Wrench Set with 6 x 6-Point Dynamic-Drive™ - 8 Pcs



**29M/**



|   |   |       |
|---|---|-------|
| 8 | 1 | 29M/8 |
|---|---|-------|

29M-8, 29M-10, 29M-12, 29M-13, 29M-14, 29M-17, 29M-19, 29M-22

Metric Double Head Offset Socket Wrench Set with 12 x 6-Point Dynamic-Drive™ - 12 Pcs



**28M/12**



|    |   |        |
|----|---|--------|
| 12 | 1 | 28M/12 |
|----|---|--------|

28M-8, 28M-9, 28M-10, 28M-11, 28M-12, 28M-13, 28M-14, 28M-15, 28M-16, 28M-17, 28M-18, 28M-19

Metric Double Head Offset Socket Wrench Set with 6 x 6-Point Dynamic-Drive™ - 10 Pcs



**29M/10**



|    |   |        |
|----|---|--------|
| 10 | 1 | 29M/10 |
|----|---|--------|

29M-8, 29M-10, 29M-11, 29M-12, 29M-13, 29M-14, 29M-16, 29M-17, 29M-18, 29M-19

Metric Double Head Offset Socket Wrench Set with 12 x 6-Point Dynamic-Drive™ - 8 Pcs



**28M/**



|   |   |       |
|---|---|-------|
| 8 | 1 | 28M/8 |
|---|---|-------|

28M-8, 28M-10, 28M-11, 28M-13, 28M-16, 28M-17, 28M-18, 28M-19

Metric Double Head Offset Socket Wrench Set with 12 x 6-Point Dynamic-Drive™ - 15 Pcs



**28M/15**



|    |   |        |
|----|---|--------|
| 15 | 1 | 28M/15 |
|----|---|--------|

28M-8, 28M-9, 28M-10, 28M-11, 28M-12, 28M-13, 28M-14, 28M-15, 28M-16, 28M-17, 28M-18, 28M-19, 28M-21, 28M-22, 28M-24

Metric Double Head Offset Socket Wrench Set with 6 x 6-Point Dynamic-Drive™ - 14 Pcs



**29M/14**



|    |   |        |
|----|---|--------|
| 14 | 1 | 29M/14 |
|----|---|--------|

29M-11, 29M-12, 29M-13, 29M-14, 29M-8, 29M-9, 29M-10, 29M-16, 29M-17, 29M-21, 29M-22, 29M-19, 29M-24, 29M-23





Metric Tubular Double Head Socket Wrench



1936M

| Size     | Quantity | Part Number |
|----------|----------|-------------|
| 6x7 mm   | 50       | 1936M-6-7   |
| 8x9 mm   | 5        | 1936M-8-9   |
| 8x10 mm  | 30       | 1936M-8-10  |
| 10x11 mm | 25       | 1936M-10-11 |
| 10x13 mm | 25       | 1936M-10-13 |
| 12x13 mm | 25       | 1936M-12-13 |
| 13x17 mm | 20       | 1936M-13-17 |
| 14x15 mm | 20       | 1936M-14-15 |
| 14x17 mm | 15       | 1936M-14-17 |
| 16x17 mm | 15       | 1936M-16-17 |
| 17x19 mm | 10       | 1936M-17-19 |
| 18x19 mm | 10       | 1936M-18-19 |
| 19x22 mm | 8        | 1936M-19-22 |
| 20x22 mm | 8        | 1936M-20-22 |
| 21x23 mm | 8        | 1936M-21-23 |
| 22x24 mm | 5        | 1936M-22-24 |
| 24x26 mm | 5        | 1936M-24-26 |
| 24x27 mm | 5        | 1936M-24-27 |
| 25x28 mm | 5        | 1936M-25-28 |
| 30x32 mm | 1        | 1936M-30-32 |
| 30x34 mm | 4        | 1936M-30-34 |
| 36x41 mm | 4        | 1936M-36-41 |
| 46x50 mm | 2        | 1936M-46-50 |

Metric Double Head Socket Wrenches with Chrome Finish



27M

| Size      | Quantity | Part Number |
|-----------|----------|-------------|
| 6x7 mm    | 10       | 27M-6-7     |
| 8x9 mm    | 10       | 27M-8-9     |
| 10x11 mm  | 10       | 27M-10-11   |
| 12x13 mm  | 10       | 27M-12-13   |
| 13x17* mm | 10       | 27M-13-17   |
| 14x15 mm  | 10       | 27M-14-15   |
| 16x17* mm | 10       | 27M-16-17   |
| 16x18* mm | 10       | 27M-16-18   |
| 18x19* mm | 10       | 27M-18-19   |
| 20x22* mm | 10       | 27M-20-22   |
| 21x23* mm | 5        | 27M-21-23   |
| 21x24* mm | 5        | 27M-21-24   |
| 24x26* mm | 5        | 27M-24-26   |

| Size      | Quantity | Part Number |
|-----------|----------|-------------|
| 24x27* mm | 5        | 27M-24-27   |
| 25x28* mm | 5        | 27M-25-28   |
| 27x29* mm | 5        | 27M-27-29   |
| 30x32* mm | 5        | 27M-30-32   |
| 6x7 mm    | 10       | SB27M-6-7   |
| 8x9 mm    | 10       | SB27M-8-9   |
| 10x11 mm  | 10       | SB27M-10-11 |
| 12x13 mm  | 10       | SB27M-12-13 |
| 14x15 mm  | 10       | SB27M-14-15 |
| 16x17* mm | 10       | SB27M-16-17 |
| 18x19* mm | 10       | SB27M-18-19 |
| 20x22* mm | 10       | SB27M-20-22 |
| 21x23* mm | 5        | SB27M-21-23 |
| 24x26* mm | 5        | SB27M-24-26 |

Sizes marked with \* in the table have a hole along the shank

Metric Tubular Double Head Socket Wrench Set with Chrome Finish - 7 Pcs



1936M/

| Size | Quantity | Part Number |
|------|----------|-------------|
| 7    | 1        | 1936M/7     |

| Size  | Quantity | Part Number |
|---|----------|-------------|
| 1936M-8-9, 1936M-10-11, 1936M-12-13, 1936M-14-15, 1936M-16-17, 1936M-18-19, 1936M-20-22 |          |             |
| 26S-610   |          |             |

Metric Tubular Double Head Socket Wrench Set with Chrome Finish - 12 Pcs



1936M/12

| Size | Quantity | Part Number |
|------|----------|-------------|
| 12   | 1        | 1936M/12    |

| Size   | Quantity | Part Number |
|--|----------|-------------|
| 1936M-6-7, 1936M-8-9, 1936M-10-11, 1936M-12-13, 1936M-14-15, 1936M-16-17, 1936M-18-19, 1936M-20-22, 1936M-21-23, 1936M-24-27, 1936M-25-28, 1936M-30-32 |          |             |
| 26S-610, 26S-1216, 26S-16  |          |             |

Metric Double Head Socket Wrench Set - 8 Pcs/Plastic Pouch



27M/T

| Size | Quantity | Part Number |
|------|----------|-------------|
| 8    | 1        | 27M/8T      |

| Size   | Quantity | Part Number |
|--|----------|-------------|
| 27M-6-7, 27M-8-9, 27M-10-11, 27M-12-13, 27M-14-15, 27M-16-17, 27M-18-19, 27M-20-22 |          |             |

Metric Double Head Socket Wrench Set - 12 Pcs/Plastic Pouch



27M/12T

| Size | Quantity | Part Number |
|------|----------|-------------|
| 12   | 1        | 27M/12T     |

| Size   | Quantity | Part Number |
|--|----------|-------------|
| 27M-6-7, 27M-8-9, 27M-10-11, 27M-12-13, 27M-14-15, 27M-16-17, 27M-18-19, 27M-20-22, 27M-21-23, 27M-24-26, 27M-25-28, 27M-30-32 |          |             |

Metric Double Head Socket Wrench Set - 6 Pcs/Cardboard Box



27M/

| Size | Quantity | Part Number |
|------|----------|-------------|
| 6    | 1        | 27M/6       |

| Size   | Quantity | Part Number |
|--|----------|-------------|
| 27M-6-7, 27M-8-9, 27M-10-11, 27M-12-13, 27M-14-15, 27M-16-17 |          |             |

Metric Double Head Socket Wrench Set - 8 Pcs/Cardboard Box



**27M/8**

|   |   |       |
|---|---|-------|
|   |   |       |
| 8 | 1 | 27M/8 |

27M-6-7, 27M-8-9, 27M-10-11, 27M-12-13, 27M-14-15, 27M-16-17, 27M-18-19, 27M-20-22



Metric Double Head Socket Wrench Set - 10 Pcs/Cardboard Box



**27M/10**

|    |   |        |
|----|---|--------|
|    |   |        |
| 10 | 1 | 27M/10 |

27M-6-7, 27M-8-9, 27M-10-11, 27M-12-13, 27M-14-15, 27M-16-17, 27M-18-19, 27M-20-22, 27M-21-23, 27M-24-26



Metric Double Head Socket Wrench Set - 12 Pcs/Cardboard Box



**27M/12**

|    |   |        |
|----|---|--------|
|    |   |        |
| 12 | 1 | 27M/12 |

27M-6-7, 27M-8-9, 27M-10-11, 27M-12-13, 27M-14-15, 27M-16-17, 27M-18-19, 27M-20-22, 27M-21-23, 27M-24-26, 27M-25-28, 27M-30-32



Stepped Tommy Bars with Chrome Finish



**26S**

|           |    |          |
|-----------|----|----------|
|           |    |          |
| 6 8 10 mm | 10 | 26S-610  |
| 12 14 mm  | 8  | 26S-1216 |
| 16 mm     | 5  | 26S-16   |

Metric Swivel Head Double End Wrenches with Bi-Hex Socket



**4040M**

|          |   |             |
|----------|---|-------------|
|          |   |             |
| 6x7 mm   | 1 | 4040M-6-7   |
| 8x9 mm   | 1 | 4040M-8-9   |
| 10x11 mm | 1 | 4040M-10-11 |
| 10x13 mm | 1 | 4040M-10-13 |
| 12x13 mm | 1 | 4040M-12-13 |
| 13x17 mm | 1 | 4040M-13-17 |
| 14x15 mm | 1 | 4040M-14-15 |
| 16x17 mm | 1 | 4040M-16-17 |
| 16x18 mm | 1 | 4040M-16-18 |
| 18x19 mm | 1 | 4040M-18-19 |
| 20x22 mm | 1 | 4040M-20-22 |
| 21x23 mm | 1 | 4040M-21-23 |

Imperial Swivel Head Double End Wrenches with Bi-Hex Socket



**4040Z**

|              |   |                 |
|--------------|---|-----------------|
|              |   |                 |
| 3/8x7/16 in  | 1 | 4040Z-3/8-7/16  |
| 1/2x9/16 in  | 1 | 4040Z-1/2-9/16  |
| 5/8x11/16 in | 1 | 4040Z-5/8-11/16 |
| 5/8x3/4 in   | 1 | 4040Z-5/8-3/4   |
| 13/16x7/8 in | 1 | 4040Z-13/16-7/8 |

Metric Double Ended Swivel Head Wrench Set with Bi-Hex Socket



**4040M/S6**

|   |   |          |
|---|---|----------|
|   |   |          |
| 6 | 1 | 4040M/S6 |

4040M-8-9, 4040M-10-11, 4040M-12-13, 4040M-14-15, 4040M-16-17, 4040M-18-19



Metric Double Ended Swivel Head Wrench Set with Bi-Hex Socket Plastic Wallet



**4040M/6T**

|   |   |          |
|---|---|----------|
|   |   |          |
| 6 | 1 | 4040M/6T |

4040M-8-9, 4040M-10-11, 4040M-12-13, 4040M-14-15, 4040M-16-17, 4040M-18-19



**MULTIFITTING KEYS**

5-in-1 Switch Cabinet Wrenches



**MK5**

|          |   |     |
|----------|---|-----|
|          |   |     |
| 97x25 mm | 1 | MK5 |

Square: 5,6,7-8 mm, Triangular: 9 mm Two-way-key: 3-5 mm





### 9-in-1 Switch Cabinet Wrenches



#### MK9



95x95 mm



1 MK9

Square: 5,6,7-8,9-10 mm, Triangular:7,8-9,10-11 mm Two-way-key: 3-5 mm  
Half-moon: 6 mm

## HOOK WRENCHES

### Flexible Head Adjustable Hook Wrenches with Chrome Finish



#### 4106



19-50 mm

32-75 mm

50-120 mm

115-165 mm

150-230 mm



10 4106-19-50

25 4106-32-75

25 4106-50-120

25 4106-115-165

10 4106-150-230

### Adjustable Pin Hook Wrenches with Chrome Finish



#### 40B



19-50 mm

32-75 mm

50-120 mm

115-165 mm

150-230 mm



25 40B-19-50

25 40B-32-75

20 40B-50-120

25 40B-115-165

10 40B-150-230

### Adjustable Pin Wrenches with Chrome Finish



#### 4307/4310



10-50 mm

22-100 mm



1 4307

1 4310

### Spare Pin for Adjustable Pin Hook Wrenches



#### 40B-SP



40B-19-50

40B-32-75

40B-50-120

40B-115-165



1 40B-19-50-SP

1 40B-32-75-SP

1 40B-50-120-SP

1 40B-115-165-SP



## Sockets & Ratchets



## SOCKET SETS

1/4" and 1/2" Square Drive Socket and Deep Socket Set with Metric Hex Profile and Combination Spanner Set



**S910**



110 x 320 x 375 mm

2 S910

Socket Set with Combination Wrenches, Hex L-Keys and Bits - 96 Pcs



**S95**



110 x 320 x 375 mm

2 S95

1/4" and 1/2" Square Drive Combination Spanner and Socket Set



**S87+7**



110 x 430 x 375 mm

2 S87+7

1 pce removable three section plastic box with lid

1/4" and 1/2" Square Drive Socket Set with Combination Spanner Set/L-Keys



**S106**



110 x 430 x 375 mm

2 S106

1/4" and 1/2" Square Drive Socket Set with Metric Hex Profile and Combination Wrench/Bit Set/Pliers



**S81MIX**



110 x 430 x 375 mm

2 S81MIX

1/4" and 1/2" Square Drive Socket Set with Combination Spanner Set



**S103**



110 x 375 x 430 mm

2 S103

1/4" and 1/2" Square Drive Socket Set with Metric Hex Profile and Combination Spanner Set



**S410**



110 x 320 x 375 mm

2 S410

1/4" and 1/2" Square Drive Socket Set with Combination Spanner Set/Socket Drivers



**S108**



110 x 430 x 375 mm

2 S108

1/4" and 1/2" Square Drive Spanner and Socket Set



**S800**



110 x 375 x 430 mm

2 S800

1/4" and 1/2" Square Drive Socket Set with Metric Hex Profile and Swivel Head Ratchet - 79 Pcs



**SW79**



100 x 215 x 370 mm

4 SW79

1/4" 3/8" and 1/2" Square Drive Socket Set with Combination Wrenches/Screwdriver Bits



**S138**



110 x 375 x 430 mm

2 S138

1/4" Square Drive Deep Socket Set with Metric Hex Profile



**S0810L**



35 x 85 x 160 mm

20 S0810L

1/4" and 1/2" Square Drive Socket Set with Metric Bi-Hex Profile and Slim Head Ratchet



**S560**



100 x 215 x 375 mm

4 S560

1/4" - 3/8" - 1/2" Square Drive Socket Set with Metric Hex Profile with Gear Wrenches Set - 137 Pcs



**S137**



105 x 370 x 430 mm

2 S137

1/4" Square Drive Socket Set with Metric Hex Profile and Screwdriver Bits/Bit Holder



**SL25**



35 x 85 x 160 mm

20 SL25

1/4" and 3/8" Square Drive Socket Set with Metric Hex Profile and Swivel Head Ratchet - 91 Pcs



**SW91**



100 x 215 x 370 mm

4 SW91

1/4" and 1/2" Square Drive Socket and Deep Socket Set with Metric Hex Profile and Combination Spanner Set - 92 Pcs



**S910AF**



110 x 320 x 370 mm

2 S910AF

1/4" Square Drive Socket Set with Metric Hex Profile and Screwdriver Bits/Bit Holder, 25 Pcs/Case Retail Pack



**SBSL25**



55 x 80 x 165 mm

5 SBSL25

SBS81



SBS61





1/4" Square Drive Socket Set with Metric Hex Profile and Screwdriver Bits



**SL24**



35 x 85 x 160 mm

1 SL24

1/4" Square Drive Socket Set with Metric Hex Profile and Ratchet/Socket Drivers



**S290**



70 x 160 x 280 mm

6 S290

1/4" Square Drive Socket Set with Metric Hex Profile and Swivel Head Ratchet - 65 Pcs



**SW65**



70 x 160 x 280 mm

6 SW65

1/4" Square Drive Socket and Deep Socket Set with Metric Hex Profile and Screwdriver Bits



**SL25L**



46 x 130 x 195 mm

10 SL25L

1/4" Square Drive Socket Set with Metric Hex Profile and Socket Drivers



**S460**



100 x 215 x 375 mm

6 S460

1/4" Square Drive Socket Set with Imperial Hex Profile and Screwdriver Bits/Bit Holder



**SL25AF**



35 x 85 x 165 mm

20 SL25AF

1/4" Square Drive Socket Set with Metric Hex Profile and Ratchet



**S160**



70 x 160 x 280 mm

6 S160

1/4" Square Drive Socket Set with Metric Hex Profile and Slim Head Ratchet - 65 Pcs



**SL65**



70 x 160 x 280 mm

6 SL65

1/4" Square Drive Socket Set with Imperial Hex Profile and Ratchet



**S160AF**



70 x 160 x 280 mm

6 S160AF

1/4" Square Drive Socket Set with Metric Hex Profile and Pear Head Ratchet



**6712R**

|                   |         |
|-------------------|---------|
|                   |         |
| 31 x 110 x 178 mm | 1 6712R |

|   |  |
|---|--|
| 6700SM-4, 6700SM-5, 6700SM-5.5, 6700SM-6, 6700SM-7, 6700SM-8, 6700SM-10, 6700SM-11, 6700SM-13 |  |
| 6950  |  |
| 6960, 6962  |  |

1/4" Square Drive Socket Set with Metric Hex Profile and Round Head Ratchet



**6712RN**

|                   |          |
|-------------------|----------|
|                   |          |
| 31 x 108 x 178 mm | 1 6712RN |

|   |  |
|---|--|
| 6700SM-4, 6700SM-5, 6700SM-5.5, 6700SM-6, 6700SM-7, 6700SM-8, 6700SM-10, 6700SM-11, 6700SM-13 |  |
| 6960, 6962  |  |
| 6950RN  |  |

1/4" Square Drive Socket Set with Metric Bi-Hex Profile and Pear Head Ratchet



**A6716DM**

|                   |           |
|-------------------|-----------|
|                   |           |
| 35 x 111 x 223 mm | 1 A6716DM |

|   |  |
|---|--|
| A6700DM-5.5, A6700DM-6, A6700DM-7, A6700DM-8, A6700DM-9, A6700DM-10, A6700DM-11, A6700DM-12, A6700DM-13, A6700DM-14 |  |
| 6956  |  |
| 6962  |  |
| 6966  |  |
| 6954  |  |
| 6950  |  |

1/4" Square Drive Socket Set with Metric Hex Profile and Round Head Ratchet/ Extension Bars



**6715MGS**

|                   |           |
|-------------------|-----------|
|                   |           |
| 34 x 113 x 223 mm | 1 6715MGS |

|   |  |
|---|--|
| SB6700SM-4, 6700SM-4.5, 6700SM-5, 6700SM-5.5, 6700SM-6, 6700SM-7, 6700SM-8, 6700SM-9, 6700SM-10, 6700SM-11, 6700SM-13 |  |
| 6954  |  |
| 6950RN  |  |
| 6956  |  |
| 6966  |  |
| 6962  |  |

1/4" Square Drive Socket Set with Metric Hex Profile and Round Head Ratchet/T-Handle



**6719MHR**

|                   |           |
|-------------------|-----------|
|                   |           |
| 50 x 110 x 220 mm | 1 6719MHR |

|   |  |
|---|--|
| 6700SM-4, 6700SM-4.5, 6700SM-5.5, 6700SM-5, 6700SM-6, 6700SM-7, 6700SM-8, 6700SM-9, 6700SM-10, 6700SM-11, 6700SM-12, 6700SM-13, 6700SM-14 |  |
| 6950RN  |  |
| 6960, 6962  |  |
| 6954  |  |
| 6956  |  |
| 6966  |  |

1/4" Square Drive Socket Set with Metric Hex Profile and Round Head Ratchet/ Screwdriver Bits/Adaptor



**6729MHR**

|                   |           |
|-------------------|-----------|
|                   |           |
| 50 x 110 x 220 mm | 1 6729MHR |

|  |  |
|--|--|
| 6700SM-4, 6700SM-5, 6700SM-6, 6700SM-7, 6700SM-8, 6700SM-9, 6700SM-10, 6700SM-11, 6700SM-13, 6700SM-14 |  |
| 6950RN   |  |
| 6960, 6962   |  |
| 6966   |  |
| 6956   |  |
| 6973A  |  |
| 59S/PH1, 59S/PH2, 59S/PH3  |  |
| 59S/PZ1, 59S/PZ2, 59S/PZ3  |  |
| 59S/0.6-4.5, 59S/0.8-5.5, 59S/1.2-6.5  |  |
| 59S/H3, 59S/H4, 59S/H5, 59S/H6   |  |





1/4" Square Drive Socket Set with Metric Hex Profile and Pear Head Ratchet/ Screwdriver Bits/Adaptor



**6729MHP**

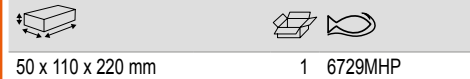

50 x 110 x 220 mm 1 6729MHP

|  |  |  |
|--|--|--|
| 6700SM-4, 6700SM-5, 6700SM-6, 6700SM-7, 6700SM-8, 6700SM-9, 6700SM-10, 6700SM-11, 6700SM-13, 6700SM-14 |  |  |
| 6950   |  |  |
| 6960, 6962   |  |  |
| 6966   |  |  |
| 6956   |  |  |
| 6973A  |  |  |
| 59S/0.6-4.5, 59S/0.8-5.5, 59S/1.2-6.5  |  |  |
| 59S/PZ1, 59S/PZ2, 59S/PZ3  |  |  |
| 59S/PH1, 59S/PH2, 59S/PH3  |  |  |
| 59S/H3, 59S/H4, 59S/H5, 59S/H6   |  |  |

1/4" Square Drive Socket Set with Metric Bi-Hex Profile and Pear Head Ratchet/ Extension Bars



**6717MBP**

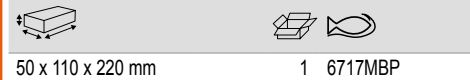

50 x 110 x 220 mm 1 6717MBP

|  |  |  |
|--|--|--|
| A6700DM-5, A6700DM-5.5, A6700DM-6, A6700DM-7, A6700DM-8, A6700DM-9, A6700DM-10, A6700DM-11, A6700DM-12, A6700DM-13, A6700DM-14 |  |  |
| 6950   |  |  |
| 6960, 6962   |  |  |
| 6954   |  |  |
| 6966   |  |  |
| 6956   |  |  |

1/4" Square Drive Socket Set with Metric Bi-Hex Profile and Pear Head Ratchet/ Screwdriver Bits



**6730MBP**

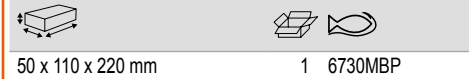

50 x 110 x 220 mm 1 6730MBP

|  |  |  |
|--|--|--|
| A6700DM-5, A6700DM-5.5, A6700DM-6, A6700DM-7, A6700DM-8, A6700DM-9, A6700DM-10, A6700DM-11, A6700DM-12, A6700DM-13, A6700DM-14 |  |  |
| 6950   |  |  |
| 6960, 6962   |  |  |
| 6954   |  |  |
| 6966   |  |  |
| 6956   |  |  |
| 6973A  |  |  |
| 59S/0.6-4.5, 59S/1.2-6.5, 59S/0.8-5.5  |  |  |
| 59S/PH1, 59S/PH2, 59S/PH3  |  |  |
| 59S/PZ1, 59S/PZ2, 59S/PZ3  |  |  |
| 59S/H3, 59S/H4, 59S/H5, 59S/H6   |  |  |

1/4" Square Drive Socket Set with Metric Hex Profile and Pear Head Ratchet/ Universal Joint



**6719SM**



41 x 113 x 223 mm 1 6719SM

|  |  |  |
|--|--|--|
| 6700SM-4, 6700SM-4.5, 6700SM-5, 6700SM-5.5, 6700SM-6, 6700SM-7, 6700SM-8, 6700SM-9, 6700SM-10, 6700SM-11, 6700SM-12, 6700SM-13 |  |  |
| 6954   |  |  |
| 6950   |  |  |
| 6956   |  |  |
| 6966   |  |  |
| 6962   |  |  |

1/4" Square Drive Socket Set with Metric Hex Profile and Round Head Ratchet/ Breaker Bar



**6715MG**



35 x 111 x 223 mm 1 6715MG

|   |  |  |
|---|--|--|
| 6700SM-4, 6700SM-4.5, 6700SM-5, 6700SM-5.5, 6700SM-6, 6700SM-7, 6700SM-8, 6700SM-9, 6700SM-10, 6700SM-11, 6700SM-12, 6700SM-13, 6700SM-14 |  |  |
| 6954  |  |  |
| 6958  |  |  |
| 6956  |  |  |
| 6962, 6960  |  |  |
| 6966  |  |  |
| 6950RN  |  |  |

1/4" Square Drive Socket Set with Metric Hex Profile and Pear Head Ratchet/ Adaptor



**6721NM**



41 x 113 x 223 mm 1 6721NM

|   |  |  |
|---|--|--|
| 6700SM-4, 6700SM-4.5, 6700SM-5, 6700SM-5.5, 6700SM-6, 6700SM-7, 6700SM-8, 6700SM-9, 6700SM-10, 6700SM-11, 6700SM-12, 6700SM-13, 6700SM-14 |  |  |
| 6954  |  |  |
| 6951  |  |  |
| 6956  |  |  |
| 6950  |  |  |
| 6962, 6960  |  |  |
| 6966  |  |  |
| 6958  |  |  |

1/4" Square Drive Socket Set with Metric Hex Profile and Pear Head Ratchet/Extension Bars



**6722M**

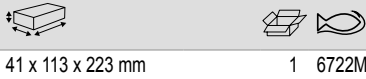

41 x 113 x 223 mm 1 6722M

|  |  |  |
|--|--|--|
| 6700SM-4, 6700SM-5, 6700SM-6, 6700SM-7, 6700SM-8, 6700SM-9, 6700SM-10, 6700SM-11, 6700SM-13, 6700SM-14 |  |  |
| 6954   |  |  |
| 6956   |  |  |
| 6950   |  |  |
| 6966   |  |  |
| 6960, 6962   |  |  |
| 6972H  |  |  |
| 59S/H3, 59S/H4, 59S/H5, 59S/H6   |  |  |
| 59S/PH1, 59S/PH2, 59S/PH3  |  |  |

1/4" Square Drive Socket Set with Metric Hex Profile and Round Head Ratchet/Spinner Handle



**6715GE**



31 x 113 x 223 mm 1 6715GE

|  |  |  |
|--|--|--|
| 6700SM-4, 6700SM-5, 6700SM-6, 6700SM-7, 6700SM-8, 6700SM-9, 6700SM-10, 6700SM-11, 6700SM-13, 6700SM-14 |  |  |
| 6956   |  |  |
| 6950RN   |  |  |
| 6954   |  |  |
| 6966   |  |  |
| 6960, 6962   |  |  |
| 6972H  |  |  |
| 59S/H3, 59S/H4, 59S/H5, 59S/H6   |  |  |
| 59S/PH1, 59S/PH2, 59S/PH3  |  |  |

1/4" Square Drive Socket Set with Metric Hex Profile and Pear Head Ratchet/Socket Drivers



**6715PZ**



41 x 113 x 223 mm 1 6715PZ

|  |  |  |
|--|--|--|
| 6700SM-4, 6700SM-4.5, 6700SM-5, 6700SM-5.5, 6700SM-6, 6700SM-7, 6700SM-8, 6700SM-9, 6700SM-10, 6700SM-11, 6700SM-12, 6700SM-13 |  |  |
| 6956   |  |  |
| 6950   |  |  |
| 6954   |  |  |
| 6962, 6960   |  |  |
| 6966   |  |  |
| 6709F-4.5, 6709F-5.5, 6709F-8  |  |  |
| 6709M-3, 6709M-4, 6709M-5, 6709M-6, 6709M-8  |  |  |
| 6709PZ-1, 6709PZ-3, 6709PZ-2   |  |  |

1/4" Square Drive Socket Set with Metric Hex Profile and Pear Head Ratchet/Screwdriver Bits



**6715GJ**

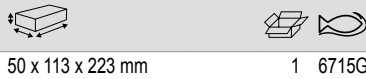

50 x 113 x 223 mm 1 6715GJ

|  |  |  |
|--|--|--|
| 6700SM-4, 6700SM-4.5, 6700SM-5, 6700SM-5.5, 6700SM-6, 6700SM-7, 6700SM-8, 6700SM-9, 6700SM-10, 6700SM-11, 6700SM-12, 6700SM-13 |  |  |
| 6956   |  |  |
| 6962, 6960   |  |  |
| 6709F-4.5, 6709F-5.5, 6709F-8  |  |  |
| 6709M-5, 6709M-6, 6709M-8, 6709M-4, 6709M-3  |  |  |
| 6954   |  |  |
| 6950   |  |  |
| 6966   |  |  |
| 6709PH-1, 6709PH-2, 6709PH-3   |  |  |

1/4" Square Drive Socket Set with Metric Hex Profile and Pear Head Ratchet/Spanner Set



**6720NM**



43 x 114 x 351 mm 1 6720NM

|   |  |  |
|---|--|--|
| 6700SM-4, 6700SM-4.5, 6700SM-5, 6700SM-5.5, 6700SM-6, 6700SM-7, 6700SM-8, 6700SM-9, 6700SM-10, 6700SM-11, 6700SM-12, 6700SM-13, 6700SM-14 |  |  |
| 1931M-4, 1931M-4.5, 1931M-9, 1931M-10, 1931M-11, 1931M-14, 1931M-13, 1931M-12, 1931M-7, 1931M-8, 1931M-6, 1931M-5.5, 1931M-5              |  |  |
| 6954  |  |  |
| 6950  |  |  |
| 6956  |  |  |
| 221 D   |  |  |
| 73721-3-80  |  |  |
| 6966  |  |  |
| 6962  |  |  |

1/4" Square Drive Socket Set with Imperial Bi-Hex Profile and Pear Head Ratchet



**A6716DZ**



41 x 113 x 223 mm 1 A6716DZ

|  |  |  |
|--|--|--|
| A6700DZ-3/16, A6700DZ-7/32, A6700DZ-1/4, A6700DZ-9/32, A6700DZ-5/16, A6700DZ-11/32, A6700DZ-3/8, A6700DZ-7/16, A6700DZ-1/2, A6700DZ-9/16 |  |  |
| 6956   |  |  |
| 6962   |  |  |
| 6966   |  |  |
| 6954   |  |  |
| 6950   |  |  |



1/4" Socket Set with Imperial Bi-Hex Profile - 18 Pcs



**A6718DZ**

41 x 113 x 223 mm 1185 g 1 A6718DZ

|  |  |
|--|--|
| 6950   |  |
| 6951   |  |
| 6956   |  |
| 6954   |  |
| 6958   |  |
| 6960, 6962   |  |
| 6966   |  |
| A6700DZ-3/16, A6700DZ-7/32, A6700DZ-1/4, A6700DZ-9/32, A6700DZ-5/16, A6700DZ-11/32, A6700DZ-3/8, A6700DZ-7/16, A6700DZ-1/2, A6700DZ-9/16 |  |

1/4" Square Drive Socket Set with Imperial Hex Profile and Pear Head Ratchet/Breaker Bars



**A6718DZ**

50 x 113 x 223 mm 1 6821NZ

|   |  |
|---|--|
| 6700SZ-1/4, 6700SZ-11/32, 6700SZ-1/2, 6700SZ-3/16, 6700SZ-5/32, 6700SZ-7/32, 6700SZ-9/32, 6700SZ-5/16, 6700SZ-3/8, 6700SZ-7/16, 6700SZ-9/16 |  |
| 6954  |  |
| 6958  |  |
| 6950  |  |
| 6956  |  |
| 6960, 6962  |  |
| 6966  |  |
| 6951  |  |

1/4" Square Drive Socket Set with Metric/Imperial Hex Profile and Pear Head Ratchet



**6715MZ**

40 x 126 x 230 mm 1 6715MZ

|   |  |
|---|--|
| 6700SM-4, 6700SM-4.5, 6700SM-5, 6700SM-5.5, 6700SM-6, 6700SM-8, 6700SM-9, 6700SM-10, 6700SM-11, 6700SM-13         |  |
| 6700SZ-7/32, 6700SZ-3/16, 6700SZ-1/4, 6700SZ-9/32, 6700SZ-5/16, 6700SZ-11/32, 6700SZ-3/8, 6700SZ-7/16, 6700SZ-1/2 |  |
| 6954  |  |
| 6950  |  |
| 6956  |  |
| 6966  |  |
| 6962  |  |

1/4" Square Drive Deep Socket 9-piece set for Metric and imperial Hex Head Screw



**A6709MZ/9**

46 x 130 x 195 mm 1 A6709MZ/9

|  |  |
|--|--|
| A6709M-2.5, A6709M-3, A6709M-4, A6709M-5, A6709M-6 |  |
| A6709Z-1/8, A6709Z-9/64, A6709Z-5/32, A6709Z-3/16  |  |
| SPAR-CASE-A6                                       |  |

1/4" Square Drive Socket Set with Metric Hex Profile and Spinner Handle



**6729SM**

25 x 55 x 190 mm 1 6729SM

|   |  |
|---|--|
| 6700SM-4, 6700SM-4.5, 6700SM-5, 6700SM-5.5, 6700SM-6, 6700SM-7, 6700SM-8, 6700SM-9, 6700SM-10, 6700SM-11, 6700SM-12, 6700SM-13, 6700SM-14 |  |
| 6956  |  |

1/4" Square Drive Socket Set with Imperial Hex Profile and Spinner Handle



**6729SZ**

25 x 55 x 190 mm 1 6729SZ

|   |  |
|---|--|
| 6700SZ-1/4, 6700SZ-11/32, 6700SZ-1/2, 6700SZ-3/16, 6700SZ-7/32, 6700SZ-3/8, 6700SZ-7/16 |  |
| 6956  |  |

1/4" Square Drive Socket Set with Metric Hex Profile



**6713MH**

13 1 6713MH

|   |  |
|---|--|
| 6700SM-4, 6700SM-4.5, 6700SM-5, 6700SM-5.5, 6700SM-6, 6700SM-7, 6700SM-8, 6700SM-9, 6700SM-10, 6700SM-11, 6700SM-12, 6700SM-13, 6700SM-14 |  |
|---|--|

1/4" Square Drive Deep Socket Set on Rail with Metric Bi-Hex Profile



**6708DMB**



8 1 6708DMB

A6800DM-6, A6800DM-7, A6800DM-8, A6800DM-9, A6800DM-10, A6800DM-11, A6800DM-12, A6800DM-13



1/4" Square Drive Socket Set with Metric Bi-Hex Profile



**6711MB**



11 1 6711MB

A6700DM-5, A6700DM-5.5, A6700DM-6, A6700DM-7, A6700DM-8, A6700DM-9, A6700DM-10, A6700DM-11, A6700DM-12, A6700DM-13, A6700DM-14



1/4" Square Drive Socket Set with TORX® Head Screw



**6706TE**



6 1 6706TE

6700TORX-E4, 6700TORX-E5, 6700TORX-E6, 6700TORX-E7, 6700TORX-E8, 6700TORX-E10



1/4" Square Drive Socket Set with Metric Hex Profile and Refrigeration Ratchet



**R6725MK**



26 x 105 x 175 mm 1 R6725MK

6700SM-7, 6700SM-8, 6700SM-10



6954



R6967



R6810M-3,4, R6810M-4, R6810M-4,5, R6810M-5, R6810M-6, R6810M-7, R6810M-8, R6810M-9, R6810M-10



6966



R6950



6962



R6964A



1/4" Square Drive Socket Set with Imperial Hex Profile and Refrigeration Ratchet



**R6725ZK**



48 x 115 x 225 mm 1 R6725ZK

6700SZ-1/4, 6700SZ-5/16, 6700SZ-11/32, 6700SZ-3/8, 6700SZ-7/16, 6700SZ-1/2



6954



R6967



R6950



6962



R6810M-6



R6964A



6966



R6810Z-3/16, R6810Z-7/32, R6810Z-1/4, R6810Z-5/16, R6810Z-3/8



R6822Z



3/8" Square Drive Deep Socket Set



**S1214L**



49 x 152 x 280 mm 10 S1214L

1/4" and 3/8" Square Drive Socket Set with Metric Hex Profile and Ratchet



**S330**



70 x 160 x 280 mm 6 S330

1/4" and 3/8" Square Drive Deep Socket Set with Metric Hex Profile and Ratchet



**S330L**



100 x 215 x 375 mm 4 S330L





3/8" Square Drive Socket Set with Metric/Imperial Hex Profile



**S380**



100 x 215 x 375 mm

4 S380

3/8" Socket Set - 34 Pcs



**SL34**



70 x 160 x 280 mm

6 SL34

Pass-Through Socket Set with Flexi Head Ratchet/Extension Bars



**S140T**



65 x 160 x 280 mm

1 S140T

1 pc pass-through extension bar, 75 mm

**SBS19-THR**

**SBS19-TH75**

SBS19-TH10, SBS19-TH11, SBS19-TH12, SBS19-TH13, SBS19-TH14, SBS19-TH15, SBS19-TH16, SBS19-TH17, SBS19-TH18, SBS19-TH19, SBS19-TH21, SBS19-TH22, SBS19-TH24

**SBS19-TH20**

Pass-Through Ratchet Set with Hex to Square Drive Adaptors



**S140T-R**



121 x 280 x 220 mm

10 S140T-R

**SBS19-THR**

**1RMA-19-3/8-SQ**

**1RMA-19-1/2-SQ**



Pass-Through Socket Set with Flexi Head Ratchet/Adaptors



**S530T**



90 x 205 x 370 mm

4 S530T

1/4" and 3/8" Square Drive Socket Set with Imperial Hex Profile and Ratchet



**S330AF**



70 x 160 x 280 mm

6 S330AF

3/8" Square Drive Socket Set with Metric Bi-Hex Profile and Round Head Ratchet/Extension Bars



**A7435DME**



40 x 150 x 500 mm

1 A7435DME

A7400DM-9, A7400DM-10, A7400DM-11, A7400DM-12, A7400DM-13, A7400DM-14, A7400DM-15, A7400DM-16, A7400DM-17, A7400DM-18, A7400DM-19, A7400DM-20, A7400DM-21, A7400DM-22



7755-3/8



7754



7760, 7762, 7761



7758



7752



7766



3/8" Square Drive Socket Set with Metric Bi-Hex Profile and Round Head Ratchet/Breaker Bar



**A7440DME**



50 x 115 x 312 mm

1 A7440DME

7755-3/8



7758



7761



A7400DM-9, A7400DM-12, A7400DM-13, A7400DM-14, A7400DM-15, A7400DM-16, A7400DM-17, A7400DM-10, A7400DM-11, A7400DM-22, A7400DM-20, A7400DM-21, A7400DM-18, A7400DM-19





3/8" Square Drive Socket Set with Metric Bi-Hex Profile and Round Head Ratchet



**7422MBR**

60 x 220 x 280 mm 1 7422MBR

A7400DM-6, A7400DM-7, A7400DM-8, A7400DM-9, A7400DM-10, A7400DM-11, A7400DM-12, A7400DM-13, A7400DM-14, A7400DM-15, A7400DM-16, A7400DM-17, A7400DM-18, A7400DM-19, A7400DM-20, A7400DM-21, A7400DM-22

7750RN  
7760, 7762  
7754  
7766

3/8" Square Drive Socket Set with Metric Hex Profile and Round Head Ratchet/T-Handle



**7422MHR**

50 x 160 x 350 mm 1 7422MHR

7400SM-6, 7400SM-7, 7400SM-8, 7400SM-9, 7400SM-10, 7400SM-11, 7400SM-12, 7400SM-13, 7400SM-14, 7400SM-15, 7400SM-16, 7400SM-17, 7400SM-18, 7400SM-19, 7400SM-20, 7400SM-21, 7400SM-22

7750RN  
7760, 7762  
7754  
7766

3/8" Square Drive Socket Set with Imperial Bi-Hex Profile and Round Head Ratchet/Breaker Bar



**A7535DZE**

165 x 500 x 45 mm 1 A7535DZE

A7400DZ-1/2, A7400DZ-17/32, A7400DZ-1/4, A7400DZ-3/4, A7400DZ-13/16, A7400DZ-19/32, A7400DZ-11/16, A7400DZ-3/8, A7400DZ-7/16, A7400DZ-5/16, A7400DZ-7/8, A7400DZ-9/16, A7400DZ-5/8

7755-3/8  
7754  
7760, 7762  
7766  
7758  
7752

3/8" Square Drive Socket Set on Rail with Metric Hex Profile



**7400SR/**

12 35 x 220 x 25 mm 1 7400SR/S12

7400SM-11, 7400SM-10, 7400SM-15, 7400SM-14, 7400SM-13, 7400SM-12, 7400SM-16, 7400SM-9, 7400SM-8, 7400SM-17, 7400SM-19, 7400SM-18

3/8" Square Drive Socket Set on Rail with Metric Bi-Hex Profile



**7409MB**

9 1 7409MB

A7400DM-7, A7400DM-8, A7400DM-10, A7400DM-11, A7400DM-13, A7400DM-15, A7400DM-17, A7400DM-19, A7400DM-22

3/8" Square Drive Deep Socket Set on Rail with Metric Bi-Hex Profile



**7408MD**

8 1 7408MD

A7402DM-10, A7402DM-11, A7402DM-12, A7402DM-13, A7402DM-14, A7402DM-16, A7402DM-17, A7402DM-19

3/8" Square Drive Socket Set for TORX® Head Screw



**7400TORX-ER/**

7 25 x 55 x 190 mm 1 7400TORX-ER/S7

7400TORX-E14, 7400TORX-E12, 7400TORX-E11, 7400TORX-E10, 7400TORX-E18, 7400TORX-E16, 7400TORX-E8



1/2" Square Drive Deep Socket Set with Metric Hex Profile



**S1612L**

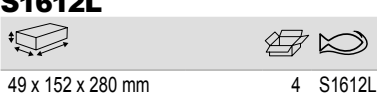

49 x 152 x 280 mm

4 S1612L

1/2" socket set with Hex bits - 9 Pcs



**S9HEX**

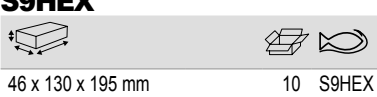

46 x 130 x 195 mm

10 S9HEX

1/2" socket set with TORX® bits - 9 Pcs



**S9TORX**

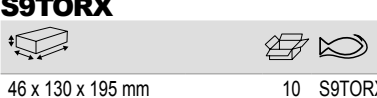

46 x 130 x 195 mm

10 S9TORX

1/2" Socket Set with Hex Bits - 18 Pcs



**S18HEX**



100 x 210 x 370 mm

4 S18HEX

1/2" Socket Set with TORX® Bits - 18 Pcs



**S18TORX**



100 x 210 x 370 mm

4 S18TORX

1/2" Square Drive Socket Set with Metric Hex Profile and Ratchet



**S240**

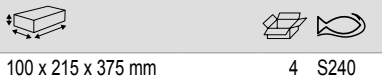

100 x 215 x 375 mm

4 S240

- SBS81
- 8166
- 8160-5, 8160-10
- 7772H
- 8158-10

7800SM-10, 7800SM-11, 7800SM-12, 7800SM-13, 7800SM-14, 7800SM-15, 7800SM-16, 7800SM-17, 7800SM-18, 7800SM-19, 7800SM-20, 7800SM-21, 7800SM-22, 7800SM-23, 7800SM-24, 7800SM-27, 7800SM-30, 7800SM-32



S240-BOX

1/2" Square Drive Socket Set with Metric Hex Profile and Combination Spanner Set



**S400**

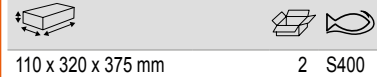

110 x 320 x 375 mm

2 S400

7800SM-10, 7800SM-11, 7800SM-12, 7800SM-13, 7800SM-14, 7800SM-15, 7800SM-16, 7800SM-17, 7800SM-18, 7800SM-19, 7800SM-20, 7800SM-21, 7800SM-22, 7800SM-23, 7800SM-24, 7800SM-25, 7800SM-26, 7800SM-27, 7800SM-28, 7800SM-30, 7800SM-32

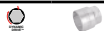

SBS81

8160-5, 8160-10

8166

7772H

8158-10

111M-7, 111M-8, 111M-9, 111M-10, 111M-11, 111M-12, 111M-13, 111M-14, 111M-15, 111M-16, 111M-17, 111M-18, 111M-19



1/2" Square Drive Socket Set with Imperial Hex Profile and Ratchet



**S240AF**

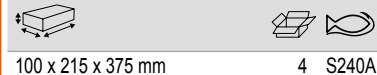

100 x 215 x 375 mm

4 S240AF

1/2" Sockets inches and Combination Spanners inches set - 35 Pcs



**S350AF**

110 x 371 x 313 mm 2 S350AF

S 3/8, S 9/16, S 1.1/4, S 1.1/16, S 1.3/16, S 15/16, S 1.1/8, S 1/2, S 1", S 5/8, S 7/8, S 3/4, S 7/16

- 815
- 703/A MP
- 763, 753
- 773

1/2" Square Drive Socket Driver Set for Metric Hex Head Screw



**7809M/10**

45 x 110 x 255 mm 1 7809M/10

7809M-5, 7809M-6, 7809M-7, 7809M-8, 7809M-9, 7809M-10, 7809M-12, 7809M-14, 7809M-17, 7809M-19

1/2" Square Drive Socket Driver Set for Imperial Hex Head Screw



**7809Z/10**

45 x 110 x 255 mm 1 7809Z/10

7809Z-3/8, 7809Z-5/16, 7809Z-7/16, 7809Z-1/4, 7809Z-19/32, 7809Z-5/8, 7809Z-17/32, 7809Z-9/16, 7809Z-1/2, 7809Z-3/16

1/2" Square Drive Socket Driver Set for TORX®/Phillips Head Screw



**7809TORX/10**

45 x 110 x 255 mm 1 7809TORX/10

7809TORX-T20, 7809TORX-T27, 7809TORX-T25, 7809TORX-T40, 7809TORX-T30, 7809TORX-T45, 7809TORX-T50, 7809TORX-T55

7809M-6, 7809M-8

1/2" Square Drive Socket Set with Metric Bi-Hex Profile and Slim Head Ratchet Metal Case



**7814DS**

60 x 185 x 445 mm 1 7814DS

7800DM-10, 7800DM-11, 7800DM-12, 7800DM-13, 7800DM-14, 7800DM-15, 7800DM-16, 7800DM-17, 7800DM-18, 7800DM-19

- 8150SL
- 8160-5, 8160-10
- 8166

1/2" Square Drive Socket Set with Metric Bi-Hex Profile and Sliding T-Handle Metal Case



**7818DS**

60 x 185 x 445 mm 1 7818DS

7800DM-8, 7800DM-10, 7800DM-11, 7800DM-12, 7800DM-13, 7800DM-14, 7800DM-15, 7800DM-16, 7800DM-17, 7800DM-18, 7800DM-19, 7800DM-21, 7800DM-22

- 8150SL
- 8160-5, 8160-10
- 8154-11
- 8166

1/2" Square Drive Socket Set with Metric Hex Profile and Round Head Ratchet



**7818MHR**

50 x 185 x 445 mm 1 7818MHR

7800SM-10, 7800SM-11, 7800SM-12, 7800SM-13, 7800SM-14, 7800SM-15, 7800SM-17, 7800SM-19, 7800SM-22, 7800SM-24, 7800SM-27, 7800SM-30, 7800SM-32

- 8150RN-1/2
- 8160-5, 8160-10
- 8154-11
- 8166





1/2" Square Drive Socket Set with Metric Hex Profile and Reversible Ratchet/Sliding T-Handle



**7825MHP**

60 x 185 x 445 mm 1 7825MHP

- 7800SM-10, 7800SM-11, 7800SM-12, 7800SM-13, 7800SM-14, 7800SM-15, 7800SM-16, 7800SM-17, 7800SM-18, 7800SM-19, 7800SM-20, 7800SM-21, 7800SM-22, 7800SM-23, 7800SM-24, 7800SM-26, 7800SM-27, 7800SM-28, 7800SM-30, 7800SM-32
- 8150-1/2
- 8160-5, 8160-10
- 8154-11
- 8166

1/2" Square Drive Socket Set with Metric Bi-Hex Profile and Reversible Ratchet/Universal Joint



**7825MBP**

60 x 185 x 445 mm 1 7825MBP

- 7800DM-10, 7800DM-11, 7800DM-12, 7800DM-13, 7800DM-14, 7800DM-15, 7800DM-16, 7800DM-17, 7800DM-18, 7800DM-19, 7800DM-20, 7800DM-21, 7800DM-22, 7800DM-23, 7800DM-24, 7800DM-26, 7800DM-27, 7800DM-28, 7800DM-30, 7800DM-32
- 8150-1/2
- 8160-5, 8160-10
- 8154-11
- 8166

1/2" Square Drive Socket Set with Metric Bi-Hex Profile and Round Head Ratchet



**7819DRN**

51 x 225 x 445 mm 1 7819DRN

- 7800DM-19, 7800DM-18, 7800DM-17, 7800DM-16, 7800DM-23, 7800DM-22, 7800DM-21, 7800DM-11, 7800DM-10, 7800DM-15, 7800DM-13, 7800DM-14, 7800DM-12, 7800DM-24, 7800DM-26, 7800DM-27, 7800DM-28, 7800DM-30, 7800DM-32
- 8150RN-1/2
- 8152-1/2
- 8166-1/2
- 8160-5, 8160-10
- 8154-11
- 8166

1/2" Square Drive Socket Set with Metric Bi-Hex Profile and Pear Head Ratchet/Extension Bars



**7888DM**

73 x 340 x 445 mm 1 7888DM

- 7800DM-10, 7800DM-11, 7800DM-12, 7800DM-13, 7800DM-14, 7800DM-15, 7800DM-16, 7800DM-17, 7800DM-18, 7800DM-19, 7800DM-20, 7800DM-21, 7800DM-22, 7800DM-23, 7800DM-24, 7800DM-26, 7800DM-27, 7800DM-28, 7800DM-30, 7800DM-32
- 8150-1/2
- 8154-11
- 8160-3, 8160-5, 8160-10
- 8166
- 8157-15

1/4" and 1/2" Square Drive Socket Set with Metric Hex Profile



**7847SS**

60 x 225 x 445 mm 1 7847SS





- 6700SM-5, 6700SM-6, 6700SM-7, 6700SM-8, 6700SM-9, 6700SM-10, 6700SM-11, 6700SM-12, 6700SM-13
- 6950SL
- 6960, 6962
- 6954
- 6966
- 6956
- 59S/PH1, 59S/PH2, 59S/PH3
- 59S/PZ1, 59S/PZ2, 59S/PZ3
- 59S/0.6-4.5, 59S/0.8-5.5, 59S/1.2-8.0
- 59S/H3, 59S/H4, 59S/H5, 59S/H6
- 7800SM-10, 7800SM-11, 7800SM-12, 7800SM-13, 7800SM-14, 7800SM-15, 7800SM-17, 7800SM-19, 7800SM-22, 7800SM-24, 7800SM-27, 7800SM-30, 7800SM-32
- 8150SL
- 6973A
- 8160-5, 8160-10
- 8154-11
- 8166

1/2" Square Drive Socket Set with Imperial Bi-Hex Profile and Slim Head Ratchet





**7817DZS**





60 x 185 x 445 mm 1 7817DZS

|  |   |   |
|--|---|---|
| 7800DZ-3/8, 7800DZ-7/16, 7800DZ-1/2, 7800DZ-9/16, 7800DZ-5/8, 7800DZ-11/16, 7800DZ-3/4, 7800DZ-13/16, 7800DZ-7/8, 7800DZ-15/16, 7800DZ-1, 7800DZ-1.1/8, 7800DZ-1.1/4 |  |  |
| 8150SL   |  |   |
| 8160-5, 8160-10  |  |   |
| 8166   |  |   |

1/2" Square Drive Socket Set with Imperial Bi-Hex Profile and Slim Head Ratchet - 13 Pcs 









|                   |   |  |  |
|-------------------|---|--|--|
| <b>7817DZS1</b>   |  |  |  |
| 60 x 185 x 445 mm | 4500 g  | 1  | 7817DZS1   |

|   |   |   |
|---|---|---|
| 7800DZ-3/8, 7800DZ-7/16, 7800DZ-1/2, 7800DZ-9/16, 7800DZ-5/8, 7800DZ-11/16, 7800DZ-3/4, 7800DZ-13/16, 7800DZ-7/8, 7800DZ-15/16, 7800DZ-1, 7800DZ-1.1/8, 7800DZ-1.1/16 |  |  |
| 8150SL  |  |   |
| 8160-5, 8160-10   |  |   |
| 8166  |  |   |

1/2" Square Drive Socket Set with Imperial Bi-Hex Profile and Slim Head Ratchet/ Sliding T-Handle 











|                   |  |   |
|-------------------|--|---|
| <b>7823DZS</b>    |  |  |
| 60 x 185 x 445 mm | 1  | 7823DZS   |

|  |  |   |
|--|--|---|
| 7800DZ-3/8, 7800DZ-7/16, 7800DZ-1/2, 7800DZ-9/16, 7800DZ-5/8, 7800DZ-11/16, 7800DZ-3/4, 7800DZ-13/16, 7800DZ-7/8, 7800DZ-15/16, 7800DZ-1, 7800DZ-1.1/8, 7800DZ-1.3/16, 7800DZ-1.1/4, 7800DZ-1.5/16 |   |  |
| 8150SL   |  |   |
| 8160-5, 8160-10  |  |   |
| 8154-11  |  |   |
| 8166   |  |   |

1/2" Square Drive Socket Set with Metric Bi-Hex Profile and Sliding T-Handle Polyester Textile Case 







|                   |   |   |
|-------------------|---|---|
| <b>7818DST</b>    |  |  |
| 60 x 220 x 480 mm | 1   | 7818DST   |

|  |  |   |
|--|--|---|
| 7800DM-8, 7800DM-10, 7800DM-11, 7800DM-12, 7800DM-13, 7800DM-14, 7800DM-15, 7800DM-16, 7800DM-17, 7800DM-18, 7800DM-19, 7800DM-21, 7800DM-22 |   |  |
| 8150SL   |  |   |
| 8160-5, 8160-10  |  |   |
| 8166   |  |   |
| 8154-11  |  |   |

1/2" Square Drive Socket Set with Metric Hex Profile and Slim Head Ratchet 



|                   |   |   |
|-------------------|---|---|
| <b>7818SST</b>    |  |  |
| 60 x 220 x 480 mm | 1   | 7818SST   |





|   |  |   |
|---|--|---|
| 7800SM-10, 7800SM-11, 7800SM-12, 7800SM-13, 7800SM-14, 7800SM-15, 7800SM-16, 7800SM-17, 7800SM-18, 7800SM-19, 7800SM-20, 7800SM-21, 7800SM-22, 7800SM-23, 7800SM-24, 7800SM-26, 7800SM-27, 7800SM-30, 7800SM-32 |   |  |
| 8150SL  |  |   |
| 8160-1/2, 8162-1/2, 8166-1/2, 8154-1/2  |  |   |

|  |  |  |
|--|--|--|
| 8160-1/2, 8162-1/2, 8166-1/2, 8154-1/2 |  |  |
|--|--|--|

1/2" Square Drive Socket Set with Metric Hex Profile and Slim Head Ratchet/ Universal Joint 









|                   |   |   |
|-------------------|---|---|
| <b>7825SST</b>    |  |  |
| 65 x 250 x 480 mm | 1   | 7825SST   |

|  |   |   |
|--|---|---|
| 7800SM-10, 7800SM-11, 7800SM-12, 7800SM-13, 7800SM-14, 7800SM-15, 7800SM-16, 7800SM-17, 7800SM-18, 7800SM-19, 7800SM-20, 7800SM-21, 7800SM-22, 7800SM-23, 7800SM-24, 7800SM-26, 7800SM-27, 7800SM-28, 7800SM-30, 7800SM-32 |    |  |
| 8150SL   |  |   |
| 8160-1/2, 8162-1/2, 8166-1/2, 8154-1/2   |  |   |

1/2" Square Drive Socket Set with Metric Bi-Hex Profile and Slim Head Ratchet 



|                   |   |   |
|-------------------|---|---|
| <b>7825DST</b>    |  |  |
| 65 x 250 x 480 mm | 1   | 7825DST   |

|  |   |   |
|--|---|---|
| 7800DM-10, 7800DM-11, 7800DM-12, 7800DM-13, 7800DM-14, 7800DM-15, 7800DM-16, 7800DM-17, 7800DM-18, 7800DM-19, 7800DM-20, 7800DM-21, 7800DM-22, 7800DM-23, 7800DM-24, 7800DM-26, 7800DM-27, 7800DM-28 |  |  |
| 8150SL   |  |   |
| 8160-1/2, 8162-1/2, 8166-1/2, 8154-1/2   |  |   |

|  |   |  |
|--|---|--|
| 8160-1/2, 8162-1/2, 8166-1/2, 8154-1/2 |  |  |
|--|---|--|





1/2" Square Drive Socket Set with Metric Bi-Hex Profile and Slim Head Ratchet/Breaker Bar



**7827DST**



65 x 250 x 480 mm

1 7827DST

7800DM-10, 7800DM-11, 7800DM-12, 7800DM-13, 7800DM-14, 7800DM-15, 7800DM-16, 7800DM-17, 7800DM-18, 7800DM-19, 7800DM-20, 7800DM-21, 7800DM-22, 7800DM-23, 7800DM-24, 7800DM-26, 7800DM-27, 7800DM-28, 7800DM-30, 7800DM-32

8150SL

8159-1/2, 8160-1/2, 8162-1/2, 8154-1/2, 8166-1/2, 8158-1/2

1/2" Square Drive Socket Set on Rail with Metric Hex Profile



**7810MH**



10

1 7810MH

7800SM-10, 7800SM-11, 7800SM-13, 7800SM-14, 7800SM-15, 7800SM-16, 7800SM-19, 7800SM-17, 7800SM-21, 7800SM-22

1/2" Square Drive Socket Set with Metric Bi-Hex Profile - 10 Pcs/Rail



**7810MB**



10

1 7810MB

7800DM-11, 7800DM-10, 7800DM-14, 7800DM-13, 7800DM-16, 7800DM-17, 7800DM-19, 7800DM-22, 7800DM-21, 7800DM-15

1/2" Square Drive Socket Set with Metric Bi-Hex Profile - 6 Pcs/Rail



**7806MD**



6

1 7806MD

7805DM-10, 7805DM-14, 7805DM-13, 7805DM-17, 7805DM-19, 7805DM-22

1/2" Square Drive Socket Set on Rail with TORX® Profile



**7807TE**



7

1 7807TE

7800TORX-E10, 7800TORX-E12, 7800TORX-E14, 7800TORX-E16, 7800TORX-E18, 7800TORX-E20, 7800TORX-E24

3/4" Square Drive Socket Set with Metric Hex Profile and Ratchet Head



**SLX 17**



375 x 430 x 110 mm

1 SLX 17

3/4" Square Drive Socket Set with Imperial Hex Profile and Ratchet Head - 17 Pcs



**SLX17AF**



70 x 375 x 430 mm

1 SLX 17AF

3/4" Square Drive Socket Set with Metric Hex Profile and Round Ratchet Head/ Sliding T-Head



**8845NM**

|  |   |        |  |
|--|---|--------|--|
|  |   |        |  |
| 94 x 206 x 591 mm  | 1 | 8845NM |  |
| 8900SM-24, 8900SM-22, 8900SM-27, 8900SM-30, 8900SM-32, 8900SM-36, 8900SM-38, 8900SM-41, 8900SM-46, 8900SM-50 |   |        |  |
| 8953   |   |        |  |
| 8954A  |   |        |  |
| 8962, 8961   |   |        |  |
| 8950N/A  |   |        |  |

3/4" Square Drive Socket Set with Metric Bi-Hex Profile and Round Ratchet Head/ Sliding T-Head



**8845DM**

|  |   |        |  |
|--|---|--------|--|
|  |   |        |  |
| 94 x 206 x 591 mm  | 1 | 8845DM |  |
| 8900DM-19, 8900DM-22, 8900DM-24, 8900DM-25, 8900DM-27, 8900DM-28, 8900DM-30, 8900DM-32, 8900DM-36, 8900DM-41, 8900DM-46, 8900DM-50, 8900DM-55, 8900DM-60 |   |        |  |
| 8953   |   |        |  |
| 8954A  |   |        |  |
| 8958A  |   |        |  |
| 8962, 8961   |   |        |  |
| 8966   |   |        |  |
| 8965   |   |        |  |
| 8961, 8962   |   |        |  |

3/4" Square Drive Socket Set with Metric Bi-Hex Profile and Round Ratchet Head



**8821MB**

|   |   |        |  |
|---|---|--------|--|
|   |   |        |  |
| 95 x 220 x 600 mm   | 1 | 8821MB |  |
| 8950N/A   |   |        |  |
| 8954  |   |        |  |
| 8965  |   |        |  |
| 8966  |   |        |  |
| 8961, 8962  |   |        |  |
| 8900DM-26, 8900DM-23, 8900DM-22, 8900DM-24, 8900DM-27, 8900DM-29, 8900DM-28, 8900DM-32, 8900DM-30, 8900DM-34, 8900DM-38, 8900DM-35, 8900DM-36, 8900DM-46, 8900DM-41, 8900DM-42, 8900DM-50 |   |        |  |

3/4" Square Drive Socket Set with Metric Bi-Hex Profile - 24 Pcs



**8840M**

|  |   |       |  |
|--|---|-------|--|
|  |   |       |  |
| 100 x 210 x 595 mm   | 1 | 8840M |  |
| 8900DM-19, 8900DM-22, 8900DM-24, 8900DM-25, 8900DM-27, 8900DM-28, 8900DM-30, 8900DM-32, 8900DM-36, 8900DM-41, 8900DM-46, 8900DM-50, 8900DM-55, 8900DM-60 |   |       |  |
| 8953   |   |       |  |
| 8950N/A  |   |       |  |
| 8951   |   |       |  |
| 8954A  |   |       |  |
| 8958A  |   |       |  |
| 8962, 8961   |   |       |  |
| 8966   |   |       |  |
| 8965   |   |       |  |
| 8172   |   |       |  |

1" Square Drive Socket Set with Metric Hex Profile and Round Head Ratchet



**9540MB**

|  |   |        |  |
|--|---|--------|--|
|  |   |        |  |
| 210 x 560 x 120 mm   | 1 | 9540MB |  |
| 9500SM-80, 9500SM-75, 9500SM-70, 9500SM-65, 9500SM-60, 9500SM-55, 9500SM-50, 9500SM-46 |   |        |  |
| 9550AB   |   |        |  |
| 9555   |   |        |  |
| 9560AB, 9563AB   |   |        |  |

1" Square Drive Socket Set with Metric Hex Profile and Round Head Ratchet/ Adaptor



**9540MBL**

|  |   |         |  |
|--|---|---------|--|
|  |   |         |  |
| 225 x 605 x 120 mm   | 1 | 9540MBL |  |
| 9500SM-80, 9500SM-77, 9500SM-71, 9500SM-70, 9500SM-67, 9500SM-65, 9500SM-63, 9500SM-60, 9500SM-75, 9500SM-46, 9500SM-50, 9500SM-54, 9500SM-55, 9500SM-58 |   |         |  |
| 9550AB   |   |         |  |
| 9560AB, 9563AB   |   |         |  |
| 9555   |   |         |  |



1" Socket Set with Imperial Bi-Hex Profile  
- 11 Pcs



**9540DZ**

|                    |          |
|--------------------|----------|
|                    |          |
| 150 x 260 x 670 mm | 1 9540DZ |

|  |  |
|--|--|
| <b>9550AB</b>  |  |
| <b>9555</b>  |  |
| <b>9563AB, 9560AB</b>  |  |
| <b>9500DZ-2.3/4, 9500DZ-2.3/8, 9500DZ-2.3/16, 9500DZ-3, 9500DZ-1.13/16, 9500DZ-3.1/8, 9500DZ-2.5/8, 9500DZ-2</b> |  |

1" Socket Set bihexagonal in inches. Metal case



**9540DZL**

|                    |           |
|--------------------|-----------|
|                    |           |
| 140 x 285 x 630 mm | 1 9540DZL |

|   |  |
|---|--|
| <b>9500DZ-2.1/4, 9500DZ-2.3/4, 9500DZ-2.3/8, 9500DZ-2.1/2, 9500DZ-2.15/16, 9500DZ-2.1/8, 9500DZ-1.7/8, 9500DZ-2.3/16, 9500DZ-3, 9500DZ-1.13/16, 9500DZ-3.1/8, 9500DZ-2.5/8, 9500DZ-2, 9500DZ-2.9/16</b> |  |
| <b>9550AB</b>   |  |
| <b>9555</b>   |  |
| <b>9563AB, 9560AB</b>   |  |
| <b>9565AB</b>   |  |

1/4"

1/4" Square Drive Sockets with Metric Hex Profile and High Polished Finish



**6700SM**

|        |                |
|--------|----------------|
|        |                |
| 4 mm   | 5 6700SM-4     |
| 4.5 mm | 5 6700SM-4.5   |
| 5 mm   | 5 6700SM-5     |
| 5.5 mm | 5 6700SM-5.5   |
| 6 mm   | 5 6700SM-6     |
| 7 mm   | 5 6700SM-7     |
| 8 mm   | 5 6700SM-8     |
| 9 mm   | 5 6700SM-9     |
| 10 mm  | 5 6700SM-10    |
| 11 mm  | 5 6700SM-11    |
| 12 mm  | 5 6700SM-12    |
| 13 mm  | 5 6700SM-13    |
| 14 mm  | 5 6700SM-14    |
| 4 mm   | 1 SB6700SM-4   |
| 4.5 mm | 1 SB6700SM-4.5 |
| 5 mm   | 1 SB6700SM-5   |
| 5.5 mm | 1 SB6700SM-5.5 |
| 6 mm   | 1 SB6700SM-6   |
| 7 mm   | 1 SB6700SM-7   |
| 8 mm   | 1 SB6700SM-8   |
| 9 mm   | 1 SB6700SM-9   |
| 10 mm  | 1 SB6700SM-10  |
| 11 mm  | 1 SB6700SM-11  |
| 12 mm  | 1 SB6700SM-12  |
| 13 mm  | 1 SB6700SM-13  |
| 14 mm  | 1 SB6700SM-14  |

SB: Retail pack on a plastic info card

1/4" Square Drive Sockets with Imperial Hex Profile



**6700SZ**

|          |                |
|----------|----------------|
|          |                |
| 1/8 in   | 5 6700SZ-1/8   |
| 5/32 in  | 5 6700SZ-5/32  |
| 3/16 in  | 5 6700SZ-3/16  |
| 7/32 in  | 5 6700SZ-7/32  |
| 1/4 in   | 5 6700SZ-1/4   |
| 9/32 in  | 5 6700SZ-9/32  |
| 5/16 in  | 5 6700SZ-5/16  |
| 11/32 in | 5 6700SZ-11/32 |
| 3/8 in   | 5 6700SZ-3/8   |
| 7/16 in  | 5 6700SZ-7/16  |
| 1/2 in   | 5 6700SZ-1/2   |

|          |                  |
|----------|------------------|
|          |                  |
| 9/16 in  | 5 6700SZ-9/16    |
| 1/8 in   | 5 SB6700SZ-1/8   |
| 5/32 in  | 1 SB6700SZ-5/32  |
| 3/16 in  | 1 SB6700SZ-3/16  |
| 7/32 in  | 1 SB6700SZ-7/32  |
| 1/4 in   | 1 SB6700SZ-1/4   |
| 9/32 in  | 1 SB6700SZ-9/32  |
| 5/16 in  | 1 SB6700SZ-5/16  |
| 11/32 in | 1 SB6700SZ-11/32 |
| 3/8 in   | 1 SB6700SZ-3/8   |
| 7/16 in  | 1 SB6700SZ-7/16  |
| 1/2 in   | 1 SB6700SZ-1/2   |
| 9/16 in  | 1 SB6700SZ-9/16  |

SB: Retail pack on a plastic info card

1/4" Square Drive Sockets with TORX® Profile



**6700TORX-E**

|     |                  |
|-----|------------------|
|     |                  |
| E4  | 5 6700TORX-E4    |
| E5  | 5 6700TORX-E5    |
| E6  | 5 6700TORX-E6    |
| E7  | 5 6700TORX-E7    |
| E8  | 5 6700TORX-E8    |
| E10 | 5 6700TORX-E10   |
| E4  | 1 SB6700TORX-E4  |
| E5  | 1 SB6700TORX-E5  |
| E6  | 1 SB6700TORX-E6  |
| E7  | 1 SB6700TORX-E7  |
| E8  | 1 SB6700TORX-E8  |
| E10 | 1 SB6700TORX-E10 |

SB: Retail pack on a plastic info card

1/4" Square Drive Sockets with Metric Square Profile for Refrigeration Ratchet



**R6810M**

|        |              |
|--------|--------------|
|        |              |
| 3.4 mm | 5 R6810M-3,4 |
| 4 mm   | 5 R6810M-4   |
| 4.5 mm | 5 R6810M-4,5 |
| 5 mm   | 5 R6810M-5   |
| 6 mm   | 5 R6810M-6   |
| 7 mm   | 1 R6810M-7   |
| 8 mm   | 5 R6810M-8   |
| 9 mm   | 5 R6810M-9   |
| 10 mm  | 5 R6810M-10  |

1/4" Square Drive Sockets with Imperial Square Profile for Refrigeration Ratchet



**R6810Z**



|         |   |             |
|---------|---|-------------|
| 3/16 in | 1 | R6810Z-3/16 |
| 7/32 in | 1 | R6810Z-7/32 |
| 1/4 in  | 1 | R6810Z-1/4  |
| 5/16 in | 1 | R6810Z-5/16 |
| 3/8 in  | 1 | R6810Z-3/8  |

1/4" Square Drive Plumbing Adaptor for Refrigeration Ratchet



**R6822Z**



5 R6822Z

1/4" Square Drive Female to Female Adaptor



**R6967**



1/4 5 R6967

1/4" Square Drive Male to Male Adaptor



**R6964A**



1 R6964A

1/4" Square Drive Sockets with Metric Bi-Hex Profile



**A6700DM**



|        |   |               |
|--------|---|---------------|
| 5 mm   | 5 | A6700DM-5     |
| 5.5 mm | 5 | A6700DM-5.5   |
| 6 mm   | 5 | A6700DM-6     |
| 7 mm   | 5 | A6700DM-7     |
| 8 mm   | 5 | A6700DM-8     |
| 9 mm   | 5 | A6700DM-9     |
| 10 mm  | 5 | A6700DM-10    |
| 11 mm  | 5 | A6700DM-11    |
| 12 mm  | 5 | A6700DM-12    |
| 13 mm  | 5 | A6700DM-13    |
| 14 mm  | 5 | A6700DM-14    |
| 5 mm   | 1 | SBA6700DM-5   |
| 5.5 mm | 1 | SBA6700DM-5.5 |
| 6 mm   | 1 | SBA6700DM-6   |
| 7 mm   | 1 | SBA6700DM-7   |
| 8 mm   | 1 | SBA6700DM-8   |
| 9 mm   | 1 | SBA6700DM-9   |
| 10 mm  | 1 | SBA6700DM-10  |
| 11 mm  | 1 | SBA6700DM-11  |
| 12 mm  | 1 | SBA6700DM-12  |
| 13 mm  | 1 | SBA6700DM-13  |
| 14 mm  | 1 | SBA6700DM-14  |

SB: Retail pack on a plastic info card

1/4" Square Drive Sockets with Imperial Bi-Hex Profile



**A6700DZ**



|         |   |              |
|---------|---|--------------|
| 3/16 in | 5 | A6700DZ-3/16 |
| 7/32 in | 5 | A6700DZ-7/32 |
| 1/4 in  | 5 | A6700DZ-1/4  |



|          |   |                 |
|----------|---|-----------------|
| 9/32 in  | 5 | A6700DZ-9/32    |
| 5/16 in  | 5 | A6700DZ-5/16    |
| 11/32 in | 5 | A6700DZ-11/32   |
| 3/8 in   | 5 | A6700DZ-3/8     |
| 7/16 in  | 5 | A6700DZ-7/16    |
| 1/2 in   | 5 | A6700DZ-1/2     |
| 9/16 in  | 5 | A6700DZ-9/16    |
| 3/16 in  | 1 | SBA6700DZ-3/16  |
| 7/32 in  | 1 | SBA6700DZ-7/32  |
| 1/4 in   | 1 | SBA6700DZ-1/4   |
| 9/32 in  | 1 | SBA6700DZ-9/32  |
| 5/16 in  | 1 | SBA6700DZ-5/16  |
| 11/32 in | 1 | SBA6700DZ-11/32 |
| 3/8 in   | 1 | SBA6700DZ-3/8   |
| 7/16 in  | 1 | SBA6700DZ-7/16  |
| 1/2 in   | 1 | SBA6700DZ-1/2   |
| 9/16 in  | 1 | SBA6700DZ-9/16  |

SB: Retail pack on a plastic info card

1/4" Square Drive Deep Sockets with Metric Bi-Hex Profile



**A6800DM**



|        |   |               |
|--------|---|---------------|
| 4 mm   | 1 | A6800DM-4     |
| 5 mm   | 1 | A6800DM-5     |
| 5.5 mm | 1 | A6800DM-5.5   |
| 6 mm   | 1 | A6800DM-6     |
| 7 mm   | 1 | A6800DM-7     |
| 8 mm   | 1 | A6800DM-8     |
| 9 mm   | 1 | A6800DM-9     |
| 10 mm  | 1 | A6800DM-10    |
| 11 mm  | 1 | A6800DM-11    |
| 12 mm  | 1 | A6800DM-12    |
| 13 mm  | 1 | A6800DM-13    |
| 14 mm  | 1 | A6800DM-14    |
| 4 mm   | 1 | SBA6800DM-4   |
| 5 mm   | 1 | SBA6800DM-5   |
| 5.5 mm | 1 | SBA6800DM-5.5 |
| 6 mm   | 1 | SBA6800DM-6   |
| 7 mm   | 1 | SBA6800DM-7   |
| 8 mm   | 1 | SBA6800DM-8   |
| 9 mm   | 1 | SBA6800DM-9   |
| 10 mm  | 1 | SBA6800DM-10  |
| 11 mm  | 1 | SBA6800DM-11  |
| 12 mm  | 1 | SBA6800DM-12  |
| 13 mm  | 1 | SBA6800DM-13  |
| 14 mm  | 1 | SBA6800DM-14  |

SB: Retail pack on a plastic info card





1/4" Square Drive Deep Sockets with Metric Hex Profile



**A6800SM**

| Size   | Quantity | Part Number |
|--------|----------|-------------|
| 4 mm   | 1        | A6800SM-4   |
| 4.5 mm | 1        | A6800SM-4.5 |
| 5 mm   | 1        | A6800SM-5   |
| 6 mm   | 1        | A6800SM-6   |
| 7 mm   | 1        | A6800SM-7   |
| 8 mm   | 1        | A6800SM-8   |
| 9 mm   | 1        | A6800SM-9   |
| 10 mm  | 1        | A6800SM-10  |
| 11 mm  | 1        | A6800SM-11  |
| 12 mm  | 1        | A6800SM-12  |
| 13 mm  | 1        | A6800SM-13  |
| 14 mm  | 1        | A6800SM-14  |
| 15 mm  | 1        | A6800SM-15  |

SB: Retail pack on a plastic info card

1/4" Square Drive Deep Sockets with Imperial Hex Profile



**A6800SZ**

| Size     | Quantity | Part Number  |
|----------|----------|--------------|
| 1/8 in   | 1        | A6800SZ-1/8  |
| 5/32" in | 1        | A6800SZ-5/32 |

1/4" Square Drive Deep Sockets with Imperial Bi-Hex Profile



**A6800DZ**

| Size     | Quantity | Part Number   |
|----------|----------|---------------|
| 3/16 in  | 1        | A6800DZ-3/16  |
| 7/32 in  | 1        | A6800DZ-7/32  |
| 1/4 in   | 1        | A6800DZ-1/4   |
| 9/32 in  | 1        | A6800DZ-9/32  |
| 5/16 in  | 1        | A6800DZ-5/16  |
| 11/32 in | 1        | A6800DZ-11/32 |
| 3/8 in   | 1        | A6800DZ-3/8   |
| 7/16 in  | 1        | A6800DZ-7/16  |

| Size     | Quantity | Part Number     |
|----------|----------|-----------------|
| 1/2 in   | 1        | A6800DZ-1/2     |
| 9/16 in  | 1        | A6800DZ-9/16    |
| 3/16 in  | 1        | SBA6800DZ-3/16  |
| 7/32 in  | 1        | SBA6800DZ-7/32  |
| 1/4 in   | 1        | SBA6800DZ-1/4   |
| 9/32 in  | 1        | SBA6800DZ-9/32  |
| 5/16 in  | 1        | SBA6800DZ-5/16  |
| 11/32 in | 1        | SBA6800DZ-11/32 |
| 3/8 in   | 1        | SBA6800DZ-3/8   |
| 7/16 in  | 1        | SBA6800DZ-7/16  |
| 1/2 in   | 1        | SBA6800DZ-1/2   |
| 9/16 in  | 1        | SBA6800DZ-9/16  |

SB: Retail pack on a plastic info card

1/4" Square Drive Swivel Sockets with Metric Bi-Hex Profile



**A6710DM**

| Size   | Quantity | Part Number |
|--------|----------|-------------|
| 5.5 mm | 1        | A6710DM-5.5 |
| 6 mm   | 1        | A6710DM-6   |
| 7 mm   | 1        | A6710DM-7   |
| 8 mm   | 1        | A6710DM-8   |
| 9 mm   | 1        | A6710DM-9   |
| 10 mm  | 1        | A6710DM-10  |
| 11 mm  | 1        | A6710DM-11  |
| 12 mm  | 1        | A6710DM-12  |
| 13 mm  | 1        | A6710DM-13  |
| 14 mm  | 1        | A6710DM-14  |

1/4" Square Drive Swivel Sockets with Imperial Bi-Hex Profile



**A6710DZ**

| Size     | Quantity | Part Number   |
|----------|----------|---------------|
| 3/16 in  | 1        | A6710DZ-3/16  |
| 7/32 in  | 1        | A6710DZ-7/32  |
| 1/4 in   | 1        | A6710DZ-1/4   |
| 9/32 in  | 1        | A6710DZ-9/32  |
| 5/16 in  | 1        | A6710DZ-5/16  |
| 11/32 in | 1        | A6710DZ-11/32 |
| 3/8 in   | 1        | A6710DZ-3/8   |
| 7/16 in  | 1        | A6710DZ-7/16  |
| 1/2 in   | 1        | A6710DZ-1/2   |
| 9/16 in  | 1        | A6710DZ-9/16  |

1/4" Square Drive Breaker Bars with Swivel Head



**6958**

| Length | Quantity | Part Number |
|--------|----------|-------------|
| 153 mm | 1        | 6958-6      |
| 153 mm | 1        | SB6958-6    |

SB: Retail pack on a plastic info card

1/4" Square Drive Sliding T-Handles



**6954**

| Length | Quantity | Part Number |
|--------|----------|-------------|
| 125 mm | 1        | 6954        |
| 125 mm | 10       | SB6954-5    |

SB: Retail pack on a plastic info card

1/4" Square Drive Spinner Handles



**6956**

| Length | Quantity | Part Number |
|--------|----------|-------------|
| 150 mm | 10       | 6956        |
| 150 mm | 1        | SB6956      |

SB: Retail pack on a plastic info card



1/4" Square Drive Extension Bars



**6960 - 6962L**

| Length | Quantity | Part Number |
|--------|----------|-------------|
| 26 mm  | 1        | 696EX-01    |
| 50 mm  | 1        | 6960        |
| 75 mm  | 10       | 6960-3      |
| 101 mm | 1        | 6961        |
| 152 mm | 1        | 6962        |
| 152 mm | 1        | 696EX-06    |
| 200 mm | 1        | 696EX-08    |
| 276 mm | 1        | 696EX-11    |
| 355 mm | 1        | 6962L       |
| 53 mm  | 1        | SB6960      |
| 75 mm  | 1        | SB6960-3    |
| 101 mm | 1        | SB6961      |
| 152 mm | 1        | SB6962      |
| 355 mm | 1        | SB6962L     |

1/4" Square Drive Universal Joints



**6966**

| Length | Quantity | Part Number |
|--------|----------|-------------|
| 35 mm  | 10       | 6966        |
| 35 mm  | 1        | SB6966      |

SB: Retail pack on a plastic info card

1/4" Square Drive to 1/4" Hex Bit Adaptors



**6709HL**

| Length | Quantity | Part Number |
|--------|----------|-------------|
| 1/4 in | 1        | 6709HL      |

1/4" Square Drive Wobbler Extension Bars



**6960-W - 6962-W**

| Length | Quantity | Part Number |
|--------|----------|-------------|
| 50 mm  | 10       | 6960W-2     |
| 100 mm | 1        | 6960W-4     |
| 150 mm | 10       | 6960W-6     |

1/4" Square Drive Universal Joints for Smooth Operations



**6968**

| Length | Quantity | Part Number |
|--------|----------|-------------|
| 35 mm  | 1        | 6968        |

1/4" Square Drive Adaptors for Hex Screwdriver Bit



**6972H**

| Length  | Quantity | Part Number |
|---------|----------|-------------|
| 1/4" in | 1        | 6972H       |
| 1/4"    | 5        | 6972H       |

1/4" Square Drive Flexible Extension Bars



**6963**

| Length | Quantity | Part Number |
|--------|----------|-------------|
| 148 mm | 1        | SB6963      |
| 150 mm | 20       | 6960F-6     |

1/4" Square Drive to 3/8" Socket Increasing Adaptors



**7765**

| Input Size | Output Size | Quantity | Part Number |
|------------|-------------|----------|-------------|
| 1/4"       | 3/8"        | 1        | 7765        |
| 1/4"       | 3/8"        | 1        | SB7765      |

1/4" Square Drive Magnetic Adaptors for 1/4" Hex Screwdriver Bit



**6973M**

| Length | Quantity | Part Number |
|--------|----------|-------------|
| 1/4"   | 1        | 6973M       |



1/4" Square Drive Adaptors for 1/4" Hex Screwdriver Bit



**6973A**

|        |    |         |
|--------|----|---------|
|        |    |         |
| 1/4 in | 10 | 6973A   |
| 1/4 in | 1  | SB6973A |

SB: retail packed on a plastic info card

1/4" Square Drive to 1/4" Socket Flat Adaptors



**6969**

|     |   |      |
|-----|---|------|
|     |   |      |
| 1/4 | 1 | 6969 |

1/4" Square Drive to 3/8" Socket Increasing Flat Adaptors



**7767**

|     |   |        |
|-----|---|--------|
|     |   |        |
| 1/4 | 1 | 7767   |
| 1/4 | 1 | SB7767 |

SB: Retail pack on a plastic info card

1/4" Square Drive Increasing Flat Adaptor Set



**8967/S3**

|                   |   |         |
|-------------------|---|---------|
|                   |   |         |
| 110 x 194 x 30 mm | 1 | 8967/S3 |

|             |  |
|-------------|--|
| <b>7767</b> |  |
| <b>8167</b> |  |
| <b>8967</b> |  |

Socket Rails for 1/4" 3/8" and 1/2" Clips



**RAIL-187/264/340**

|        |    |          |
|--------|----|----------|
|        |    |          |
| 203 mm | 10 | RAIL-8   |
| 250 mm | 10 | RAIL-10  |
| 340 mm | 3  | RAIL-340 |

Rail-Clips for 1/4" Sockets/Socket Drivers



**C1/4**

|       |    |           |
|-------|----|-----------|
|       |    |           |
| 17 mm | 25 | CLIPS-1/4 |

1/4" Square Drive Socket Drivers for Slotted Head Screw



**6709F**

|        |        |   |             |
|--------|--------|---|-------------|
|        |        |   |             |
| 0.6 mm | 4.5 mm | 5 | 6709F-4.5   |
| 0.8 mm | 5.5 mm | 5 | 6709F-5.5   |
| 0.9 mm | 6.5 mm | 5 | 6709F-6.5   |
| 1.2 mm | 8 mm   | 5 | 6709F-8     |
| 0.6 mm | 4.5 mm | 1 | SB6709F-4.5 |
| 0.8 mm | 5.5 mm | 1 | SB6709F-5.5 |
| 0.9 mm | 6.5 mm | 1 | SB6709F-6.5 |
| 1.2 mm | 8 mm   | 1 | SB6709F-8   |

SB: Retail pack on a plastic info card

1/4" Square Drive Socket Drivers for Philips Head Screw



**6709PH**

|   |   |            |
|---|---|------------|
|   |   |            |
| 1 | 5 | 6709PH-1   |
| 2 | 5 | 6709PH-2   |
| 3 | 5 | 6709PH-3   |
| 1 | 1 | SB6709PH-1 |
| 2 | 1 | SB6709PH-2 |
| 3 | 1 | SB6709PH-3 |

SB: Retail pack on a plastic info card

1/4" Square Drive Socket Drivers for Pozidriv Head Screw



**6709PZ**

|   |   |          |
|---|---|----------|
|   |   |          |
| 1 | 5 | 6709PZ-1 |
| 2 | 5 | 6709PZ-2 |
| 3 | 5 | 6709PZ-3 |

|   |   |            |
|---|---|------------|
|   |   |            |
| 1 | 1 | SB6709PZ-1 |
| 2 | 1 | SB6709PZ-2 |
| 3 | 1 | SB6709PZ-3 |

SB: Retail pack on a plastic info card

1/4" Square Drive Socket Drivers for TORX® Head Screw



|                 |   |                |
|-----------------|---|----------------|
| <b>6709TORX</b> |   |                |
|                 |   |                |
| T6              | 5 | 6709TORX-T6    |
| T7              | 5 | 6709TORX-T7    |
| T8              | 5 | 6709TORX-T8    |
| T9              | 5 | 6709TORX-T9    |
| T10             | 5 | 6709TORX-T10   |
| T15             | 5 | 6709TORX-T15   |
| T20             | 5 | 6709TORX-T20   |
| T25             | 5 | 6709TORX-T25   |
| T27             | 5 | 6709TORX-T27   |
| T30             | 5 | 6709TORX-T30   |
| T40             | 5 | 6709TORX-T40   |
| T8              | 1 | SB6709TORX-T8  |
| T9              | 1 | SB6709TORX-T9  |
| T10             | 1 | SB6709TORX-T10 |
| T15             | 1 | SB6709TORX-T15 |
| T20             | 1 | SB6709TORX-T20 |
| T25             | 1 | SB6709TORX-T25 |
| T27             | 1 | SB6709TORX-T27 |
| T30             | 1 | SB6709TORX-T30 |
| T40             | 1 | SB6709TORX-T40 |

SB: Retail pack on a plastic info card

1/4" Square Drive Socket Drivers for TORX® Tamper-Resistant Head Screw



|                   |   |                  |
|-------------------|---|------------------|
| <b>6709TORX-R</b> |   |                  |
|                   |   |                  |
| TR 8              | 1 | 6709TORX-R-T8    |
| TR 10             | 1 | 6709TORX-R-T10   |
| TR 15             | 1 | 6709TORX-R-T15   |
| TR 20             | 1 | 6709TORX-R-T20   |
| TR 25             | 1 | 6709TORX-R-T25   |
| TR 8              | 1 | SB6709TORX-R-T8  |
| TR 10             | 1 | SB6709TORX-R-T10 |

|       |   |                  |
|-------|---|------------------|
|       |   |                  |
| TR 15 | 1 | SB6709TORX-R-T15 |
| TR 20 | 1 | SB6709TORX-R-T20 |
| TR 25 | 1 | SB6709TORX-R-T25 |

SB: Retail pack on a plastic info card

1/4" Square Drive Socket Drivers for TORX® PLUS® Head Screw



|                |    |             |
|----------------|----|-------------|
| <b>6709-IP</b> |    |             |
|                |    |             |
| IP6            |    | 1 6709-IP6  |
| IP7            |    | 1 6709-IP7  |
| IP8            |    | 1 6709-IP8  |
| IP9            |    | 1 6709-IP9  |
| IP10           | M3 | 1 6709-IP10 |
| IP15           | -  | 1 6709-IP15 |
| IP20           | M4 | 1 6709-IP20 |
| IP25           | M5 | 1 6709-IP25 |
| IP27           | -  | 1 6709-IP27 |
| IP30           | M6 | 1 6709-IP30 |
| IP40           | M8 | 1 6709-IP40 |
| IP45           | -  | 1 6709-IP45 |

SB: Retail pack

1/4" Square Drive Socket Drivers for Hex Head Screw



|              |   |           |
|--------------|---|-----------|
| <b>6709M</b> |   |           |
|              |   |           |
| 3 mm         | 5 | 6709M-3   |
| 4 mm         | 5 | 6709M-4   |
| 5 mm         | 5 | 6709M-5   |
| 6 mm         | 5 | 6709M-6   |
| 8 mm         | 5 | 6709M-8   |
| 10 mm        | 5 | 6709M-10  |
| 3 mm         | 1 | SBS67M-3  |
| 4 mm         | 1 | SB6709M-4 |
| 5 mm         | 1 | SB6709M-5 |
| 6 mm         | 1 | SB6709M-6 |
| 8 mm         | 1 | SB6709M-8 |

SB: Retail pack on a plastic info card

1/4" Square Drive Deep Socket Drivers for Metric Hex Head Screw



|               |   |              |
|---------------|---|--------------|
| <b>A6709M</b> |   |              |
|               |   |              |
| 2.5 mm        | 1 | A6709M-2.5   |
| 3 mm          | 1 | A6709M-3     |
| 4 mm          | 1 | A6709M-4     |
| 5 mm          | 1 | A6709M-5     |
| 6 mm          | 1 | A6709M-6     |
| 2.5 mm        | 1 | SBA6709M-2.5 |
| 3 mm          | 1 | SBA6709M-3   |
| 4 mm          | 1 | SBA6709M-4   |
| 5 mm          | 1 | SBA6709M-5   |
| 6 mm          | 1 | SBA6709M-6   |

SB: Retail pack on a plastic info card

1/4" Square Drive Deep Socket Drivers for Imperial Hex Head Screw



|               |   |               |
|---------------|---|---------------|
| <b>A6709Z</b> |   |               |
|               |   |               |
| 1/8 in        | 1 | A6709Z-1/8    |
| 9/64 in       | 1 | A6709Z-9/64   |
| 5/32 in       | 1 | A6709Z-5/32   |
| 3/16 in       | 1 | A6709Z-3/16   |
| 1/8 in        | 1 | SBA6709Z-1/8  |
| 9/64 in       | 1 | SBA6709Z-9/64 |
| 5/32 in       | 1 | SBA6709Z-5/32 |
| 3/16 in       | 1 | SBA6709Z-3/16 |

SB: Retail pack on a plastic info card



1/4" Slim Head Reversible Ratchets with 72 Teeth and 5° Action Angle



**6950SL**

|        |    |   |        |
|--------|----|---|--------|
|        |    |   |        |
| 119 mm | 72 | 1 | 6950SL |

1/4" Refrigeration Reversible Ratchets with 32 Teeth and 11.5° Action Angle



**R6950**



|        |    |   |       |
|--------|----|---|-------|
|        |    |   |       |
| 160 mm | 32 | 1 | R6950 |

1/4" Swivel Head Ratchets with 72 Teeth and 5° Action Angle



**8120-1/4**

|        |    |    |          |
|--------|----|----|----------|
|        |    |    |          |
| 149 mm | 72 | 20 | 8120-1/4 |

1/4" Pear Head Reversible Ratchets with 72 Teeth and 5° Action Angle



**6950**

|        |    |   |        |
|--------|----|---|--------|
|        |    |   |        |
| 121 mm | 72 | 1 | 6950   |
| 121 mm | 72 | 1 | SB6950 |

1/4" Pear Head Reversible Ratchets with 60 Teeth and 6° Action Angle



**SBS61**

|        |    |   |       |
|--------|----|---|-------|
|        |    |   |       |
| 145 mm | 60 | 1 | SBS61 |

SB: Retail pack

Combination Ratcheting Wrenches for Screwdriver Bits



**2058-BR**

|    |   |         |
|----|---|---------|
|    |   |         |
| 52 | 1 | 2058-BR |

1/4" Round Head Reversible Ratchets with 72 Teeth and 5° Action Angle



**6950RN**

|        |    |   |          |
|--------|----|---|----------|
|        |    |   |          |
| 121 mm | 72 | 1 | 6950RN   |
| 121 mm | 72 | 1 | SB6950RN |

1/4" Pear Head Short Reversible Ratchets with 60 Teeth and 6° Action Angle



**SBS61S**

|        |    |   |        |
|--------|----|---|--------|
|        |    |   |        |
| 120 mm | 60 | 1 | SBS61S |

SB: Retail pack

Ratcheting Adaptors with 52 Teeth for 1/4" Ratchet



**6951**

|       |   |      |
|-------|---|------|
|       |   |      |
| 40 mm | 1 | 6951 |

Spare Part Kit for 6950SL 1/4" Ratchet



**6950SL-SPARE**

|    |        |                |
|----|--------|----------------|
|    |        |                |
| 10 | 6950SL | 1 6950SL-SPARE |

1/4" Spare Part Kit for 6950 Ratchet



**6950-SPARE**

|    |      |              |
|----|------|--------------|
|    |      |              |
| 12 | 6950 | 1 6950-SPARE |

Spare Part Kit for 6950RN 1/4" Ratchet



**6950RN-SPARE**

|   |        |                |
|---|--------|----------------|
|   |        |                |
| 6 | 6950RN | 1 6950RN-SPARE |

**3/8"**

3/8" Square Drive Sockets with Metric Hex Profile and High Polished Finish



**7400SM**

|       |             |
|-------|-------------|
|       |             |
| 6 mm  | 5 7400SM-6  |
| 7 mm  | 5 7400SM-7  |
| 8 mm  | 5 7400SM-8  |
| 9 mm  | 5 7400SM-9  |
| 10 mm | 5 7400SM-10 |
| 11 mm | 5 7400SM-11 |
| 12 mm | 5 7400SM-12 |
| 13 mm | 5 7400SM-13 |
| 14 mm | 5 7400SM-14 |
| 15 mm | 5 7400SM-15 |
| 16 mm | 5 7400SM-16 |
| 17 mm | 5 7400SM-17 |
| 18 mm | 5 7400SM-18 |
| 19 mm | 5 7400SM-19 |
| 20 mm | 5 7400SM-20 |
| 21 mm | 5 7400SM-21 |
| 22 mm | 5 7400SM-22 |

|       |               |
|-------|---------------|
| 6 mm  | 1 SB7400SM-6  |
| 7 mm  | 1 SB7400SM-7  |
| 8 mm  | 1 SB7400SM-8  |
| 9 mm  | 1 SB7400SM-9  |
| 10 mm | 1 SB7400SM-10 |
| 11 mm | 1 SB7400SM-11 |
| 12 mm | 1 SB7400SM-12 |
| 13 mm | 1 SB7400SM-13 |
| 14 mm | 1 SB7400SM-14 |
| 15 mm | 1 SB7400SM-15 |
| 16 mm | 1 SB7400SM-16 |
| 17 mm | 1 SB7400SM-17 |
| 18 mm | 1 SB7400SM-18 |
| 19 mm | 1 SB7400SM-19 |
| 20 mm | 1 SB7400SM-20 |
| 21 mm | 1 SB7400SM-21 |
| 22 mm | 1 SB7400SM-22 |

SB: Retail pack on a plastic info card

3/8" Square Drive Sockets with Metric Bi-Hex Profile



**A7400DM**

|      |             |
|------|-------------|
|      |             |
| 6 mm | 5 A7400DM-6 |
| 7 mm | 5 A7400DM-7 |
| 8 mm | 5 A7400DM-8 |

|       |              |
|-------|--------------|
|       |              |
| 9 mm  | 5 A7400DM-9  |
| 10 mm | 5 A7400DM-10 |
| 11 mm | 5 A7400DM-11 |
| 12 mm | 5 A7400DM-12 |
| 13 mm | 5 A7400DM-13 |
| 14 mm | 5 A7400DM-14 |
| 15 mm | 5 A7400DM-15 |
| 16 mm | 5 A7400DM-16 |
| 17 mm | 5 A7400DM-17 |
| 18 mm | 5 A7400DM-18 |
| 19 mm | 5 A7400DM-19 |
| 20 mm | 5 A7400DM-20 |
| 21 mm | 5 A7400DM-21 |
| 22 mm | 5 A7400DM-22 |
| 24 mm | 5 A7400DM-24 |

|       |                |
|-------|----------------|
| 6 mm  | 1 SBA7400DM-6  |
| 7 mm  | 1 SBA7400DM-7  |
| 8 mm  | 1 SBA7400DM-8  |
| 9 mm  | 1 SBA7400DM-9  |
| 10 mm | 1 SBA7400DM-10 |
| 11 mm | 1 SBA7400DM-11 |
| 12 mm | 1 SBA7400DM-12 |
| 13 mm | 1 SBA7400DM-13 |
| 14 mm | 1 SBA7400DM-14 |
| 15 mm | 1 SBA7400DM-15 |
| 16 mm | 1 SBA7400DM-16 |
| 17 mm | 1 SBA7400DM-17 |
| 18 mm | 1 SBA7400DM-18 |
| 19 mm | 1 SBA7400DM-19 |
| 20 mm | 1 SBA7400DM-20 |
| 21 mm | 1 SBA7400DM-21 |
| 22 mm | 1 SBA7400DM-22 |

SB: Retail pack on a plastic info card

3/8" Square Drive Sockets with Imperial Hex Profile



**7400SZ**

|           |                |
|-----------|----------------|
|           |                |
| 1/4" in   | 1 7400SZ-1/4   |
| 5/16" in  | 1 7400SZ-5/16  |
| 11/32" in | 1 7400SZ-11/32 |
| 3/8" in   | 1 7400SZ-3/8   |
| 7/16" in  | 1 7400SZ-7/16  |
| 1/2" in   | 1 7400SZ-1/2   |
| 9/16" in  | 1 7400SZ-9/16  |
| 5/8" in   | 1 7400SZ-5/8   |
| 11/16" in | 1 7400SZ-11/16 |
| 3/4" in   | 1 7400SZ-3/4   |
| 13/16" in | 1 7400SZ-13/16 |
| 7/8" in   | 1 7400SZ-7/8   |





### 3/8" Square Drive Sockets with Imperial Bi-Hex Profile



#### A7400DZ

| A7400DZ  |                   |
|----------|-------------------|
| 1/4 in   | 5 A7400DZ-1/4     |
| 5/16 in  | 5 A7400DZ-5/16    |
| 3/8 in   | 5 A7400DZ-3/8     |
| 7/16 in  | 5 A7400DZ-7/16    |
| 1/2 in   | 5 A7400DZ-1/2     |
| 17/32 in | 5 A7400DZ-17/32   |
| 9/16 in  | 5 A7400DZ-9/16    |
| 19/32 in | 5 A7400DZ-19/32   |
| 5/8 in   | 5 A7400DZ-5/8     |
| 11/16 in | 5 A7400DZ-11/16   |
| 3/4 in   | 5 A7400DZ-3/4     |
| 13/16 in | 5 A7400DZ-13/16   |
| 7/8 in   | 5 A7400DZ-7/8     |
| <hr/>    |                   |
| 1/4 in   | 1 SBA7400DZ-1/4   |
| 5/16 in  | 1 SBA7400DZ-5/16  |
| 3/8 in   | 1 SBA7400DZ-3/8   |
| 7/16 in  | 1 SBA7400DZ-7/16  |
| 1/2 in   | 1 SBA7400DZ-1/2   |
| 17/32 in | 1 SBA7400DZ-17/32 |
| 9/16 in  | 1 SBA7400DZ-9/16  |
| 19/32 in | 1 SBA7400DZ-19/32 |
| 5/8 in   | 1 SBA7400DZ-5/8   |
| 11/16 in | 1 SBA7400DZ-11/16 |
| 3/4 in   | 1 SBA7400DZ-3/4   |
| 13/16 in | 1 SBA7400DZ-13/16 |
| 7/8 in   | 1 SBA7400DZ-7/8   |

SB: Retail pack on a plastic info card

### 3/8" Square Drive Deep Sockets with Metric Bi-Hex Profile



#### A7402DM

| A7402DM |                |
|---------|----------------|
| 7 mm    | 1 A7402DM-7    |
| 8 mm    | 1 A7402DM-8    |
| 9 mm    | 1 A7402DM-9    |
| 10 mm   | 5 A7402DM-10   |
| 11 mm   | 1 A7402DM-11   |
| 12 mm   | 1 A7402DM-12   |
| 13 mm   | 1 A7402DM-13   |
| 14 mm   | 1 A7402DM-14   |
| 15 mm   | 1 A7402DM-15   |
| 16 mm   | 1 A7402DM-16   |
| 17 mm   | 1 A7402DM-17   |
| 18 mm   | 1 A7402DM-18   |
| 19 mm   | 1 A7402DM-19   |
| 21 mm   | 1 A7402DM-21   |
| <hr/>   |                |
| 7 mm    | 1 SBA7402DM-7  |
| 8 mm    | 1 SBA7402DM-8  |
| 9 mm    | 1 SBA7402DM-9  |
| 10 mm   | 1 SBA7402DM-10 |
| 11 mm   | 1 SBA7402DM-11 |
| 12 mm   | 1 SBA7402DM-12 |
| 13 mm   | 1 SBA7402DM-13 |
| 14 mm   | 1 SBA7402DM-14 |
| 15 mm   | 1 SBA7402DM-15 |
| 16 mm   | 1 SBA7402DM-16 |
| 17 mm   | 1 SBA7402DM-17 |
| 18 mm   | 1 SBA7402DM-18 |
| 19 mm   | 1 SBA7402DM-19 |

SB: Retail pack on a plastic info card

### 3/8" Square Drive Swivel Sockets with Imperial Bi-Hex Profile



#### A7410DZ

| A7410DZ  |                 |
|----------|-----------------|
| 5/16 in  | 1 A7410DZ-5/16  |
| 3/8 in   | 1 A7410DZ-3/8   |
| 7/16 in  | 1 A7410DZ-7/16  |
| 1/2 in   | 1 A7410DZ-1/2   |
| 9/16 in  | 1 A7410DZ-9/16  |
| 5/8 in   | 1 A7410DZ-5/8   |
| 11/16 in | 1 A7410DZ-11/16 |
| 3/4 in   | 1 A7410DZ-3/4   |

### 3/8" Square Drive Deep Sockets with Imperial Bi-Hex Profile



#### A7402DZ

| A7402DZ  |                 |
|----------|-----------------|
| 1/4 in   | 1 A7402DZ-1/4   |
| 5/16 in  | 1 A7402DZ-5/16  |
| 3/8 in   | 1 A7402DZ-3/8   |
| 7/16 in  | 1 A7402DZ-7/16  |
| 1/2 in   | 1 A7402DZ-1/2   |
| 9/16 in  | 1 A7402DZ-9/16  |
| 19/32 in | 1 A7402DZ-19/32 |
| 5/8 in   | 1 A7402DZ-5/8   |
| 11/16 in | 1 A7402DZ-11/16 |
| 3/4 in   | 1 A7402DZ-3/4   |
| 13/16 in | 1 A7402DZ-13/16 |

| A7402DZ  |                   |
|----------|-------------------|
| 7/8 in   | 1 A7402DZ-7/8     |
| 1/4 in   | 1 SBA7402DZ-1/4   |
| 5/16 in  | 1 SBA7402DZ-5/16  |
| 3/8 in   | 1 SBA7402DZ-3/8   |
| 7/16 in  | 1 SBA7402DZ-7/16  |
| 1/2 in   | 1 SBA7402DZ-1/2   |
| 9/16 in  | 1 SBA7402DZ-9/16  |
| 19/32 in | 1 SBA7402DZ-19/32 |
| 5/8 in   | 1 SBA7402DZ-5/8   |
| 11/16 in | 1 SBA7402DZ-11/16 |
| 3/4 in   | 1 SBA7402DZ-3/4   |
| 13/16 in | 1 SBA7402DZ-13/16 |
| 7/8 in   | 1 SBA7402DZ-7/8   |

SB: Retail pack on a plastic info card

### 3/8" Square Drive Sockets with TORX® Profile



#### 7400TORX-E

| 7400TORX-E |                  |
|------------|------------------|
| E8         | 5 7400TORX-E8    |
| E10        | 5 7400TORX-E10   |
| E11        | 5 7400TORX-E11   |
| E12        | 5 7400TORX-E12   |
| E14        | 5 7400TORX-E14   |
| E16        | 5 7400TORX-E16   |
| E18        | 5 7400TORX-E18   |
| <hr/>      |                  |
| E8         | 1 SB7400TORX-E8  |
| E10        | 1 SB7400TORX-E10 |
| E11        | 1 SB7400TORX-E11 |
| E12        | 1 SB7400TORX-E12 |
| E14        | 1 SB7400TORX-E14 |
| E16        | 1 SB7400TORX-E16 |
| E18        | 1 SB7400TORX-E18 |

SB: Retail pack on a plastic info card

### 3/8" Square Drive Speeders with Rotary Steel Handle



#### 7752

| 7752   |        |
|--------|--------|
| 435 mm | 1 7752 |

3/8" Square Drive Swivel Head Breaker Bars



**7758**

| Length (L) | Quantity | Part Number |
|------------|----------|-------------|
| 250 mm     | 1        | 7758-10     |
| 250 mm     | 1        | SB7758-10   |

SB: Retail pack on a plastic info card

3/8" Square Drive Extension Bars



**7760-7761-7762**

| Length (L) | Quantity | Part Number |
|------------|----------|-------------|
| 75 mm      | 1        | 7760        |
| 127 mm     | 1        | 7761        |
| 250 mm     | 1        | 7762        |
| 75 mm      | 1        | SB7760      |
| 127 mm     | 1        | SB7761      |
| 252 mm     | 1        | SB7762      |

3/8" Square Drive Flexible Extension Bars

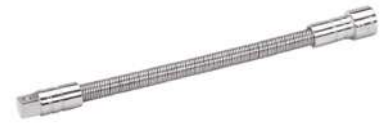

**7759**

| Length (L) | Quantity | Part Number |
|------------|----------|-------------|
| 200 mm     | 1        | 7759        |
| 200 mm     | 1        | SB7759      |

3/8" Square Drive Sliding T-Handles



**7754**

| Length (L) | Quantity | Part Number |
|------------|----------|-------------|
| 160 mm     | 1        | 7754        |
| 160 mm     | 1        | SB7754      |

SB: Retail pack on a plastic info card

3/8" Square Drive Wobbler Extension Bars



**7760-W - 7761-W**

| Length (L) | Quantity | Part Number |
|------------|----------|-------------|
| 75 mm      | 10       | 7760W-3     |
| 150 mm     | 10       | 7760W-6     |

3/8" Square Drive Universal Joints



**7766**

| Length (L) | Quantity | Part Number |
|------------|----------|-------------|
| 51.5 mm    | 1        | 7766        |
| 51.5 mm    | 1        | SB7766      |

SB: Retail pack on a plastic info card

3/8" Square Drive Spinner Handles



**7756**

| Length (L) | Quantity | Part Number |
|------------|----------|-------------|
| 150 mm     | 6        | 7756        |
| 150 mm     | 1        | SB7756      |

SB: With hanging clip

3/8" Square Drive Knurled Extension Bars



**776EX**

| Length (L) | Quantity | Part Number |
|------------|----------|-------------|
| 26 mm      | 1        | 776EX-01    |
| 76 mm      | 1        | 776EX-03    |
| 101 mm     | 1        | 776EX-04    |
| 150 mm     | 1        | 776EX-06    |
| 200 mm     | 1        | 776EX-08    |
| 275 mm     | 1        | 776EX-11    |

3/8" Square Drive Universal Joints for Smooth Operations



**7768**

| Length (L) | Quantity | Part Number |
|------------|----------|-------------|
| 45 mm      | 1        | 7768        |



3/8" Square Drive to 1/4" Socket  
Decreasing Adaptors



**7764**

|     |     |   |        |
|-----|-----|---|--------|
|     |     |   |        |
| 3/8 | 1/4 | 1 | 7764   |
| 3/8 | 1/4 | 1 | SB7764 |

3/8" Square Drive Adaptors for 1/4" Hex  
Screwdriver Bits



**SBS780**

|        |    |         |
|--------|----|---------|
|        |    |         |
| 1/4 in | 20 | 7773A   |
| 1/4 in | 1  | SB7773A |

3/8" Slim Head Reversible Ratchets with  
72 Teeth and 5° Action Angle



**7750SL**

|        |    |   |        |
|--------|----|---|--------|
|        |    |   |        |
| 204 mm | 72 | 1 | 7750SL |

3/8" Square Drive to 1/2" Socket  
Increasing Adaptors



**8164-1/2**

|      |      |   |          |
|------|------|---|----------|
|      |      |   |          |
| 3/8" | 1/2" | 1 | 8164-1/2 |

3/8" Square Drive Adaptors for 5/16" Hex  
Screwdriver Bit



**7106J**

|         |   |       |
|---------|---|-------|
|         |   |       |
| 5/16 in | 1 | 7106J |

3/8" Pear Head Reversible Ratchets with  
80 Teeth and 4.5° Action Angle



**7750**

|        |    |   |        |
|--------|----|---|--------|
|        |    |   |        |
| 207 mm | 80 | 1 | 7750   |
| 207 mm | 80 | 1 | SB7750 |

3/8" Square Drive to 1/2" Socket  
Increasing Flat Adaptors



**8167**

|     |     |   |      |
|-----|-----|---|------|
|     |     |   |      |
| 3/8 | 1/2 | 1 | 8167 |

Rail-Clips for 3/8" Sockets/Socket Drivers



**C3/8**

|       |    |           |
|-------|----|-----------|
|       |    |           |
| 19 mm | 25 | CLIPS-3/8 |

3/8" Round Head Reversible Ratchets with  
72 Teeth and 5° Action Angle



**7750RN**

|        |    |   |          |
|--------|----|---|----------|
|        |    |   |          |
| 206 mm | 72 | 1 | 7750RN   |
| 206 mm | 72 | 1 | SB7750RN |

3/8" Pear Head Reversible Ratchets with 60 Teeth and 6° Action Angle



**SBS750**

|        |    |    |        |
|--------|----|----|--------|
|        |    |    |        |
| 200 mm | 60 | 10 | SBS750 |

SB: Retail pack

3/8" Swivel Head Ratchets with 72 Teeth and 5° Action Angle



**8120-3/8**

|        |    |    |          |
|--------|----|----|----------|
|        |    |    |          |
| 223 mm | 72 | 10 | 8120-3/8 |

3/8" Flex Head Reversible Ratchets with 60 Teeth and 6° Action Angle



**7710**

|        |    |   |      |
|--------|----|---|------|
|        |    |   |      |
| 278 mm | 60 | 1 | 7710 |

3/8" Square Drive Socket Drivers for Slotted Head Screw



**7409F**

|        |   |             |
|--------|---|-------------|
|        |   |             |
| 6.4 mm | 5 | 7409F-6.5   |
| 7.9 mm | 5 | 7409F-8     |
| 9.5 mm | 5 | 7409F-10    |
| 6.4 mm | 1 | SB7409F-6.5 |
| 7.9 mm | 1 | SB7409F-8   |
| 9.5 mm | 1 | SB7409F-10  |

SB: Retail pack on a plastic info card

3/8" Square Drive Socket Drivers for Philips Head Screw



**7409PH**

|   |   |            |
|---|---|------------|
|   |   |            |
| 1 | 5 | 7409PH-1   |
| 2 | 5 | 7409PH-2   |
| 3 | 5 | 7409PH-3   |
| 1 | 1 | SB7409PH-1 |
| 2 | 1 | SB7409PH-2 |
| 3 | 1 | SB7409PH-3 |

SB: Retail pack on a plastic info card

3/8" Square Drive Socket Drivers for TORX® Head Screw



**7409TORX**

|     |   |              |
|-----|---|--------------|
|     |   |              |
| T20 | 5 | 7409TORX-T20 |
| T25 | 5 | 7409TORX-T25 |
| T27 | 5 | 7409TORX-T27 |

|     |   |                |
|-----|---|----------------|
|     |   |                |
| T30 | 5 | 7409TORX-T30   |
| T40 | 5 | 7409TORX-T40   |
| T45 | 5 | 7409TORX-T45   |
| T50 | 5 | 7409TORX-T50   |
| T20 | 1 | SB7409TORX-T20 |
| T25 | 1 | SB7409TORX-T25 |
| T27 | 1 | SB7409TORX-T27 |
| T30 | 1 | SB7409TORX-T30 |
| T40 | 1 | SB7409TORX-T40 |
| T45 | 1 | SB7409TORX-T45 |
| T50 | 1 | SB7409TORX-T50 |

SB: Retail pack on a plastic info card

3/8" Square Drive Socket Drivers for TORX® Tamper-Resistant Head Screw



**7409TORX-R**

|       |   |                  |
|-------|---|------------------|
|       |   |                  |
| TR 27 | 5 | 7409TORX-R-T27   |
| TR 30 | 5 | 7409TORX-R-T30   |
| TR 40 | 5 | 7409TORX-R-T40   |
| TR 45 | 5 | 7409TORX-R-T45   |
| TR 50 | 5 | 7409TORX-R-T50   |
| TR 27 | 1 | SB7409TORX-R-T27 |
| TR 30 | 1 | SB7409TORX-R-T30 |
| TR 40 | 1 | SB7409TORX-R-T40 |
| TR 45 | 1 | SB7409TORX-R-T45 |
| TR 50 | 1 | SB7409TORX-R-T50 |

SB: Retail pack on a plastic info card

3/8" Square Drive Socket Driver Set for TORX® Tamper-Resistant Head Screw



**7409TORX-TRR/**

|   |                  |   |                 |
|---|------------------|---|-----------------|
|   |                  |   |                 |
| 5 | 25 x 55 x 190 mm | 1 | 7409TORX-TRR/S5 |

7409TORX-R-T40, 7409TORX-R-T30, 7409TORX-R-T27, 7409TORX-R-T50, 7409TORX-R-T45



### 3/8" Square Drive Deep Socket Drivers for TORX® Head Screw



#### 7409TORX-L

|     |   |                  |
|-----|---|------------------|
| T25 | 5 | 7409TORX-T25-L   |
| T30 | 5 | 7409TORX-T30-L   |
| T40 | 5 | 7409TORX-T40-L   |
| T45 | 5 | 7409TORX-T45-L   |
| T50 | 5 | 7409TORX-T50-L   |
| T25 | 1 | SB7409TORX-T25-L |
| T30 | 1 | SB7409TORX-T30-L |
| T40 | 1 | SB7409TORX-T40-L |
| T45 | 1 | SB7409TORX-T45-L |
| T50 | 1 | SB7409TORX-T50-L |

SB: Retail pack on a plastic info card

### 3/8" Square Drive Socket Drivers for Hex Head Screw



#### 7409M

|       |   |            |
|-------|---|------------|
| 3 mm  | 5 | 7409M-3    |
| 4 mm  | 5 | 7409M-4    |
| 5 mm  | 5 | 7409M-5    |
| 6 mm  | 5 | 7409M-6    |
| 7 mm  | 5 | 7409M-7    |
| 8 mm  | 5 | 7409M-8    |
| 10 mm | 5 | 7409M-10   |
| 3 mm  | 1 | SB7409M-3  |
| 4 mm  | 1 | SB7409M-4  |
| 5 mm  | 1 | SB7409M-5  |
| 6 mm  | 1 | SB7409M-6  |
| 7 mm  | 1 | SB7409M-7  |
| 8 mm  | 1 | SB7409M-8  |
| 10 mm | 1 | SB7409M-10 |

SB: Retail pack on a plastic info card

### 3/8" Square Drive Ball Socket Drivers for Hex Head Screw



#### 7409BH

|      |   |          |
|------|---|----------|
| 4 mm | 5 | 7409BH-4 |
| 5 mm | 1 | 7409BH-5 |
| 6 mm | 5 | 7409BH-6 |

|       |   |             |
|-------|---|-------------|
| 8 mm  | 5 | 7409BH-8    |
| 10 mm | 5 | 7409BH-10   |
| 4 mm  | 1 | SB7409BH-4  |
| 5 mm  | 1 | SB7409BH-5  |
| 6 mm  | 1 | SB7409BH-6  |
| 8 mm  | 1 | SB7409BH-8  |
| 10 mm | 1 | SB7409BH-10 |

SB: Retail pack on a plastic info card

### 19 mm Pass Through Sockets with Metric Spline Profile



#### SBS19-TH

|       |   |            |
|-------|---|------------|
| 10 mm | 1 | SBS19-TH10 |
| 11 mm | 1 | SBS19-TH11 |
| 12 mm | 1 | SBS19-TH12 |
| 13 mm | 1 | SBS19-TH13 |
| 14 mm | 1 | SBS19-TH14 |
| 15 mm | 1 | SBS19-TH15 |
| 16 mm | 1 | SBS19-TH16 |
| 17 mm | 1 | SBS19-TH17 |
| 18 mm | 1 | SBS19-TH18 |
| 19 mm | 1 | SBS19-TH19 |
| 21 mm | 1 | SBS19-TH21 |
| 22 mm | 1 | SBS19-TH22 |
| 24 mm | 1 | SBS19-TH24 |

SB: Retail pack

### 3/8" Square Drive Socket Drivers for Hex Head Screws



#### 7409Z

|         |         |   |            |
|---------|---------|---|------------|
| 1/8 in  | 47 mm   | 1 | 7409Z-1/8  |
| 5/32 in | 47 mm   | 1 | 7409Z-5/32 |
| 3/16 in | 47 mm   | 1 | 7409Z-3/16 |
| 7/32 in | 47 mm   | 1 | 7409Z-7/32 |
| 1/4 in  | 47 mm   | 1 | 7409Z-1/4  |
| 3/8 in  | 50.5 mm | 1 | 7409Z-3/8  |

### 19 mm Pass Through 75 mm extension



#### SBS19-TH75

|       |   |            |
|-------|---|------------|
| 75 mm | 1 | SBS19-TH75 |
|-------|---|------------|

### 3/8" Square Drive Socket Driver Set on Rail for Hex Head Screw



#### 7409MR/

|   |                  |   |           |
|---|------------------|---|-----------|
| 7 | 25 x 55 x 190 mm | 1 | 7409MR/S7 |
|---|------------------|---|-----------|

7409M-3, 7409M-4, 7409M-10, 7409M-8, 7409M-7, 7409M-6, 7409M-5

### Ratcheting Adaptors with 52 Teeth for 3/8" Ratchet



#### 7751

|       |       |    |      |
|-------|-------|----|------|
| 55 mm | 175 g | 10 | 7751 |
|-------|-------|----|------|

### Spare Part Kit for 7750SL 3/8" Ratchet



#### 7750SL-SPARE

|    |        |   |              |
|----|--------|---|--------------|
| 12 | 7750SL | 1 | 7750SL-SPARE |
|----|--------|---|--------------|



Spare Part Kit for 7750 3/8" Ratchet



**7750-SPARE**

|    |      |              |
|----|------|--------------|
|    |      |              |
| 11 | 7750 | 1 7750-SPARE |

Spare Part Kit for 7750RN 3/8" Ratchet



**7750RN-SPARE**

|   |        |                |
|---|--------|----------------|
|   |        |                |
| 6 | 7750RN | 1 7750RN-SPARE |

1/2"

1/2" Square Drive Sockets with Metric Hex Profile and High Polished Finish



**7800SM**

| 8 mm  | 10 7800SM-8  |
|-------|--------------|
| 9 mm  | 10 7800SM-9  |
| 10 mm | 10 7800SM-10 |
| 11 mm | 10 7800SM-11 |
| 12 mm | 10 7800SM-12 |
| 13 mm | 10 7800SM-13 |
| 14 mm | 10 7800SM-14 |
| 15 mm | 10 7800SM-15 |

| 16 mm | 10 7800SM-16  |
|-------|---------------|
| 17 mm | 10 7800SM-17  |
| 18 mm | 10 7800SM-18  |
| 19 mm | 10 7800SM-19  |
| 20 mm | 10 7800SM-20  |
| 21 mm | 10 7800SM-21  |
| 22 mm | 10 7800SM-22  |
| 23 mm | 10 7800SM-23  |
| 24 mm | 10 7800SM-24  |
| 25 mm | 10 7800SM-25  |
| 26 mm | 10 7800SM-26  |
| 27 mm | 10 7800SM-27  |
| 28 mm | 10 7800SM-28  |
| 29 mm | 10 7800SM-29  |
| 30 mm | 10 7800SM-30  |
| 32 mm | 10 7800SM-32  |
| 33 mm | 10 7800SM-33  |
| 34 mm | 10 7800SM-34  |
| 36 mm | 10 7800SM-36  |
| 8 mm  | 1 SB7800SM-8  |
| 9 mm  | 1 SB7800SM-9  |
| 10 mm | 1 SB7800SM-10 |
| 11 mm | 1 SB7800SM-11 |
| 12 mm | 1 SB7800SM-12 |
| 13 mm | 1 SB7800SM-13 |
| 14 mm | 1 SB7800SM-14 |
| 15 mm | 1 SB7800SM-15 |
| 16 mm | 1 SB7800SM-16 |
| 17 mm | 1 SB7800SM-17 |
| 18 mm | 1 SB7800SM-18 |
| 19 mm | 1 SB7800SM-19 |
| 21 mm | 1 SB7800SM-20 |
| 21 mm | 1 SB7800SM-21 |
| 22 mm | 1 SB7800SM-22 |
| 23 mm | 1 SB7800SM-23 |
| 24 mm | 1 SB7800SM-24 |
| 25 mm | 1 SB7800SM-25 |
| 26 mm | 1 SB7800SM-26 |
| 27 mm | 1 SB7800SM-27 |
| 28 mm | 1 SB7800SM-28 |
| 29 mm | 1 SB7800SM-29 |
| 30 mm | 1 SB7800SM-30 |
| 32 mm | 1 SB7800SM-32 |
| 33 mm | 1 SB7800SM-33 |
| 34 mm | 1 SB7800SM-34 |
| 36 mm | 1 SB7800SM-36 |

SB: Retail pack on a plastic info card

1/2" Square Drive Deep Sockets with Metric Hex Profile



**7805SM**

| 10 mm | 10 7805SM-10 |
|-------|--------------|
| 11 mm | 10 7805SM-11 |
| 12 mm | 10 7805SM-12 |
| 13 mm | 10 7805SM-13 |
| 14 mm | 10 7805SM-14 |

| 15 mm | 10 7805SM-15  |
|-------|---------------|
| 16 mm | 10 7805SM-16  |
| 17 mm | 10 7805SM-17  |
| 18 mm | 10 7805SM-18  |
| 19 mm | 10 7805SM-19  |
| 20 mm | 10 7805SM-20  |
| 21 mm | 10 7805SM-21  |
| 22 mm | 10 7805SM-22  |
| 23 mm | 10 7805SM-23  |
| 24 mm | 10 7805SM-24  |
| 25 mm | 10 7805SM-25  |
| 26 mm | 10 7805SM-26  |
| 27 mm | 10 7805SM-27  |
| 28 mm | 10 7805SM-28  |
| 29 mm | 10 7805SM-29  |
| 30 mm | 10 7805SM-30  |
| 32 mm | 10 7805SM-32  |
| 34 mm | 10 7805SM-34  |
| 10 mm | 1 SB7805SM-10 |
| 11 mm | 1 SB7805SM-11 |
| 12 mm | 1 SB7805SM-12 |
| 13 mm | 1 SB7805SM-13 |
| 14 mm | 1 SB7805SM-14 |
| 15 mm | 1 SB7805SM-15 |
| 16 mm | 1 SB7805SM-16 |
| 17 mm | 1 SB7805SM-17 |
| 18 mm | 1 SB7805SM-18 |
| 19 mm | 1 SB7805SM-19 |
| 20 mm | 1 SB7805SM-20 |
| 21 mm | 1 SB7805SM-21 |
| 22 mm | 1 SB7805SM-22 |
| 23 mm | 1 SB7805SM-23 |
| 24 mm | 1 SB7805SM-24 |
| 25 mm | 1 SB7805SM-25 |
| 26 mm | 1 SB7805SM-26 |
| 27 mm | 1 SB7805SM-27 |
| 28 mm | 1 SB7805SM-28 |
| 29 mm | 1 SB7805SM-29 |
| 30 mm | 1 SB7805SM-30 |
| 32 mm | 1 SB7805SM-32 |
| 34 mm | 1 SB7805SM-34 |

SB: Retail pack on a plastic info card

1/2" Square Drive Deep Sockets with Imperial Hex Profile



**7805SZ**

| 1.3/16 in | 1 7805SZ-1.3/16 |
|-----------|-----------------|
| 1.1/4 in  | 1 7805SZ-1.1/4  |
| 1.5/16 in | 1 7805SZ-1.5/16 |
| 1.3/8 in  | 1 7805SZ-1.3/8  |
| 1.7/16 in | 1 7805SZ-1.7/16 |
| 1.1/2 in  | 1 7805SZ-1.1/2  |



1/2" Square Drive Sockets with Metric Bi-Hex Profile



**7800DM**

| 8 mm  | 10 | 7800DM-8    |  |
|-------|----|-------------|--|
| 9 mm  | 10 | 7800DM-9    |  |
| 10 mm | 10 | 7800DM-10   |  |
| 11 mm | 10 | 7800DM-11   |  |
| 12 mm | 10 | 7800DM-12   |  |
| 13 mm | 10 | 7800DM-13   |  |
| 14 mm | 10 | 7800DM-14   |  |
| 15 mm | 10 | 7800DM-15   |  |
| 16 mm | 10 | 7800DM-16   |  |
| 17 mm | 10 | 7800DM-17   |  |
| 18 mm | 10 | 7800DM-18   |  |
| 19 mm | 10 | 7800DM-19   |  |
| 20 mm | 10 | 7800DM-20   |  |
| 21 mm | 10 | 7800DM-21   |  |
| 22 mm | 10 | 7800DM-22   |  |
| 23 mm | 10 | 7800DM-23   |  |
| 24 mm | 10 | 7800DM-24   |  |
| 25 mm | 10 | 7800DM-25   |  |
| 26 mm | 10 | 7800DM-26   |  |
| 27 mm | 10 | 7800DM-27   |  |
| 28 mm | 10 | 7800DM-28   |  |
| 29 mm | 10 | 7800DM-29   |  |
| 30 mm | 10 | 7800DM-30   |  |
| 31 mm | 10 | 7800DM-31   |  |
| 32 mm | 10 | 7800DM-32   |  |
| 33 mm | 10 | 7800DM-33   |  |
| 34 mm | 10 | 7800DM-34   |  |
| 36 mm | 10 | 7800DM-36   |  |
| <hr/> |    |             |  |
| 8 mm  | 1  | SB7800DM-8  |  |
| 9 mm  | 1  | SB7800DM-9  |  |
| 10 mm | 1  | SB7800DM-10 |  |
| 11 mm | 1  | SB7800DM-11 |  |
| 12 mm | 1  | SB7800DM-12 |  |
| 13 mm | 1  | SB7800DM-13 |  |
| 14 mm | 1  | SB7800DM-14 |  |
| 15 mm | 1  | SB7800DM-15 |  |
| 16 mm | 1  | SB7800DM-16 |  |
| 17 mm | 1  | SB7800DM-17 |  |
| 18 mm | 1  | SB7800DM-18 |  |
| 19 mm | 1  | SB7800DM-19 |  |
| 21 mm | 1  | SB7800DM-20 |  |
| 21 mm | 1  | SB7800DM-21 |  |
| 22 mm | 1  | SB7800DM-22 |  |
| 23 mm | 1  | SB7800DM-23 |  |
| 24 mm | 1  | SB7800DM-24 |  |
| 25 mm | 1  | SB7800DM-25 |  |
| 26 mm | 1  | SB7800DM-26 |  |
| 27 mm | 1  | SB7800DM-27 |  |
| 28 mm | 1  | SB7800DM-28 |  |
| 29 mm | 1  | SB7800DM-29 |  |
| 30 mm | 1  | SB7800DM-30 |  |
| 31 mm | 1  | SB7800DM-31 |  |
| 32 mm | 1  | SB7800DM-32 |  |
| 33 mm | 1  | SB7800DM-33 |  |
| 34 mm | 1  | SB7800DM-34 |  |
| 36 mm | 1  | SB7800DM-36 |  |

SB: Retail pack on a plastic info card

1/2" Square Drive Sockets with Imperial Bi-Hex Profile



**7800DZ**

| 5/16 in   | 10 | 7800DZ-5/16     |  |
|-----------|----|-----------------|--|
| 11/32 in  | 10 | 7800DZ-11/32    |  |
| 3/8 in    | 10 | 7800DZ-3/8      |  |
| 13/32 in  | 10 | 7800DZ-13/32    |  |
| 7/16 in   | 10 | 7800DZ-7/16     |  |
| 1/2 in    | 10 | 7800DZ-1/2      |  |
| 9/16 in   | 10 | 7800DZ-9/16     |  |
| 19/32 in  | 10 | 7800DZ-19/32    |  |
| 5/8 in    | 10 | 7800DZ-5/8      |  |
| 11/16 in  | 10 | 7800DZ-11/16    |  |
| 3/4 in    | 10 | 7800DZ-3/4      |  |
| 25/32 in  | 10 | 7800DZ-25/32    |  |
| 13/16 in  | 10 | 7800DZ-13/16    |  |
| 7/8 in    | 10 | 7800DZ-7/8      |  |
| 15/16 in  | 10 | 7800DZ-15/16    |  |
| 1 in      | 10 | 7800DZ-1        |  |
| 1 1/16 in | 10 | 7800DZ-1.1/16   |  |
| 1 1/8 in  | 10 | 7800DZ-1.1/8    |  |
| 1 3/16 in | 10 | 7800DZ-1.3/16   |  |
| 1 1/4 in  | 10 | 7800DZ-1.1/4    |  |
| 1.5/16 in | 10 | 7800DZ-1.5/16   |  |
| 1.3/8 in  | 10 | 7800DZ-1.3/8    |  |
| 1.7/16 in | 1  | 7800DZ-1.7/16   |  |
| 1.1/2 in  | 10 | 7800DZ-1.1/2    |  |
| <hr/>     |    |                 |  |
| 3/8 in    | 1  | SB7800DZ-3/8    |  |
| 7/16 in   | 1  | SB7800DZ-7/16   |  |
| 1/2 in    | 1  | SB7800DZ-1/2    |  |
| 9/16 in   | 1  | SB7800DZ-9/16   |  |
| 19/32 in  | 1  | SB7800DZ-19/32  |  |
| 5/8 in    | 1  | SB7800DZ-5/8    |  |
| 11/16 in  | 1  | SB7800DZ-11/16  |  |
| 3/4 in    | 1  | SB7800DZ-3/4    |  |
| 25/32 in  | 1  | SB7800DZ-25/32  |  |
| 13/16 in  | 1  | SB7800DZ-13/16  |  |
| 7/8 in    | 1  | SB7800DZ-7/8    |  |
| 15/16 in  | 1  | SB7800DZ-15/16  |  |
| 1 in      | 1  | SB7800DZ-1      |  |
| 1.1/16 in | 1  | SB7800DZ-1.1/16 |  |
| 1.1/8 in  | 1  | SB7800DZ-1.1/8  |  |
| 1.3/16 in | 1  | SB7800DZ-1.3/16 |  |
| 1.1/4 in  | 1  | SB7800DZ-1.1/4  |  |
| 1.5/16 in | 1  | SB7800DZ-1.5/16 |  |

SB: Retail pack on a plastic info card

1/2" Square Drive Sockets with Imperial Hex Profile



**7800SZ**

| 3/8 in    | 10 | 7800SZ-3/8    |  |
|-----------|----|---------------|--|
| 7/16 in   | 10 | 7800SZ-7/16   |  |
| 1/2 in    | 10 | 7800SZ-1/2    |  |
| 9/16 in   | 10 | 7800SZ-9/16   |  |
| 11/16 in  | 10 | 7800SZ-11/16  |  |
| 3/4 in    | 10 | 7800SZ-3/4    |  |
| 13/16 in  | 10 | 7800SZ-13/16  |  |
| 7/8 in    | 10 | 7800SZ-7/8    |  |
| 1 3/16 in | 10 | 7800SZ-1.3/16 |  |

1/2" Square Drive Deep Sockets with Metric Bi-Hex Profile



**7805DM**

| 10 mm | 10 | 7805DM-10   |  |
|-------|----|-------------|--|
| 12 mm | 10 | 7805DM-12   |  |
| 13 mm | 10 | 7805DM-13   |  |
| 14 mm | 10 | 7805DM-14   |  |
| 15 mm | 10 | 7805DM-15   |  |
| 16 mm | 10 | 7805DM-16   |  |
| 17 mm | 10 | 7805DM-17   |  |
| 18 mm | 10 | 7805DM-18   |  |
| 19 mm | 10 | 7805DM-19   |  |
| 21 mm | 10 | 7805DM-21   |  |
| 22 mm | 10 | 7805DM-22   |  |
| 23 mm | 10 | 7805DM-23   |  |
| 24 mm | 10 | 7805DM-24   |  |
| 26 mm | 10 | 7805DM-26   |  |
| 27 mm | 10 | 7805DM-27   |  |
| 30 mm | 10 | 7805DM-30   |  |
| 32 mm | 10 | 7805DM-32   |  |
| 34 mm | 10 | 7805DM-34   |  |
| <hr/> |    |             |  |
| 10 mm | 1  | SB7805DM-10 |  |
| 12 mm | 1  | SB7805DM-12 |  |
| 13 mm | 1  | SB7805DM-13 |  |
| 14 mm | 1  | SB7805DM-14 |  |
| 15 mm | 1  | SB7805DM-15 |  |
| 16 mm | 1  | SB7805DM-16 |  |
| 17 mm | 1  | SB7805DM-17 |  |
| 18 mm | 1  | SB7805DM-18 |  |
| 19 mm | 1  | SB7805DM-19 |  |
| 21 mm | 1  | SB7805DM-21 |  |
| 22 mm | 1  | SB7805DM-22 |  |
| 23 mm | 1  | SB7805DM-23 |  |

|       |   |             |
|-------|---|-------------|
|       |   |             |
| 24 mm | 1 | SB7805DM-24 |
| 26 mm | 1 | SB7805DM-26 |
| 27 mm | 1 | SB7805DM-27 |
| 30 mm | 1 | SB7805DM-30 |
| 32 mm | 1 | SB7805DM-32 |
| 34 mm | 1 | SB7805DM-34 |

SB: Retail pack on a plastic info card

1/2" Square Drive Deep Sockets with Imperial Bi-Hex Profile



**7805DZ**

|            |    |               |
|------------|----|---------------|
|            |    |               |
| 5/8 in     | 10 | 7805DZ-5/8    |
| 11/16 in   | 10 | 7805DZ-11/16  |
| 3/4 in     | 10 | 7805DZ-3/4    |
| 13/16 in   | 10 | 7805DZ-13/16  |
| 7/8 in     | 10 | 7805DZ-7/8    |
| 15/16 in   | 10 | 7805DZ-15/16  |
| 1 in       | 10 | 7805DZ-1      |
| 1.1/16 in  | 10 | 7805DZ-1.1/16 |
| 1.1/8 in   | 10 | 7805DZ-1.1/8  |
| 1.13/16 in | 10 | 7805DZ-1.3/16 |
| 1.1/4 in   | 10 | 7805DZ-1.1/4  |
| 1.5/16 in  | 10 | 7805DZ-1.5/16 |
| 1.3/8 in   | 10 | 7805DZ-1.3/8  |
| 1.7/16 in  | 10 | 7805DZ-1.7/16 |
| 1.1/2 in   | 10 | 7805DZ-1.1/2  |

1/2" Square Drive Sockets with TORX® Profile



**7800TORX-E**

|     |   |                |
|-----|---|----------------|
|     |   |                |
| E8  | 1 | 7800TORX-E8    |
| E10 | 1 | 7800TORX-E10   |
| E11 | 1 | 7800TORX-E11   |
| E12 | 1 | 7800TORX-E12   |
| E14 | 1 | 7800TORX-E14   |
| E16 | 1 | 7800TORX-E16   |
| E18 | 1 | 7800TORX-E18   |
| E20 | 1 | 7800TORX-E20   |
| E24 | 1 | 7800TORX-E24   |
| E8  | 1 | SB7800TORX-E8  |
| E10 | 1 | SB7800TORX-E10 |
| E11 | 1 | SB7800TORX-E11 |
| E12 | 1 | SB7800TORX-E12 |

|     |   |                |
|-----|---|----------------|
|     |   |                |
| E14 | 1 | SB7800TORX-E14 |
| E16 | 1 | SB7800TORX-E16 |
| E18 | 1 | SB7800TORX-E18 |
| E20 | 1 | SB7800TORX-E20 |
| E24 | 1 | SB7800TORX-E24 |

SB: Retail pack on a plastic info card

1/2" Square Drive Speeders with Rotary Steel Handle



**8152-1/2**

|        |   |          |
|--------|---|----------|
|        |   |          |
| 425 mm | 1 | 8152-1/2 |

1/2" Square Drive Swivel Head Breaker Bars



**8157**

|        |    |           |
|--------|----|-----------|
|        |    |           |
| 257 mm | 1  | 8157-10   |
| 390 mm | 1  | 8157-15   |
| 600 mm | 1  | 8157-24   |
| 900 mm | 10 | 8157-36   |
| 257 mm | 1  | SB8157-10 |
| 390 mm | 1  | SB8157-15 |
| 600 mm | 1  | SB8157-24 |
| 900 mm | 1  | SB8157-36 |

1/2" Square Drive Swivel Head Breaker Bars with Matte Finish



**8158**

|        |   |           |
|--------|---|-----------|
|        |   |           |
| 270 mm | 1 | 8158-10   |
| 390 mm | 1 | 8158-15   |
| 270 mm | 1 | SB8158-10 |
| 390 mm | 1 | SB8158-15 |

1/2" Square Drive Offset Handles



**8167-1/2**

|        |    |      |
|--------|----|------|
|        |    |      |
| 180 mm | 10 | 8167 |

1/2" Square Drive Sliding T-Handles



**8154**

|        |    |           |
|--------|----|-----------|
|        |    |           |
| 280 mm | 1  | SB8154-11 |
| 280 mm | 10 | 8154-11   |

3/8" to 1/2" Adaptor Sliding Head



**7772H**

|      |      |    |       |
|------|------|----|-------|
|      |      |    |       |
| 3/8" | 1/2" | 10 | 7772H |

1/2" Square Drive Extension Bars



**8160**

|        |    |           |
|--------|----|-----------|
|        |    |           |
| 75 mm  | 10 | 8160-3    |
| 125 mm | 10 | 8160-5    |
| 250 mm | 10 | 8160-10   |
| 75 mm  | 1  | SB8160-3  |
| 125 mm | 1  | SB8160-5  |
| 250 mm | 1  | SB8160-10 |



1/2" Square Drive Wobbler Extension Bars



**8159-W - 8162-W**

| 75 mm  | 10 | 8160W-3  |
|--------|----|----------|
| 125 mm | 10 | 8160W-5  |
| 250 mm | 10 | 8160W-10 |

1/2" Square Drive Universal Joints for Smooth Operations



**8168**

| 62 mm | 1 | 8168 |
|-------|---|------|

1/2" Square Drive to 3/4" Socket Increasing Adaptors



**8172**

| 1/2" | 3/4" | 10 | 8172   |
|------|------|----|--------|
| 1/2" | 3/4" | 1  | SB8172 |

1/2" Square Drive Locking Extension Bars



**8160-B**

| 125 mm | 1 | 8160-B |
|--------|---|--------|

1/2" Square Drive to 3/8" Socket Decreasing Adaptors



**8171**

| 1/2" | 3/8" | 10 | 8171   |
|------|------|----|--------|
| 1/2" | 3/8" | 1  | SB8171 |

1/2" Square Drive to 3/4" Socket Increasing Flat Adaptors



**8967**

| 1/2" | 3/4" | 1 | 8967 |
|------|------|---|------|

1/2" Square Drive Universal Joints



**8166**

| 72 mm | 10 | 8166   |
|-------|----|--------|
| 72 mm | 1  | SB8166 |

Combination Stepped Hexagon Keys for Internal Lug Valve Sizes



**8195-key**

| 140 g | 50 | 8195-KEY |
|-------|----|----------|

For using with 8195-R

1/2" Square Drive Adaptors for 5/16" Hex Screwdriver Bit



**7106S**

| 5/16 in | 10 | 8174A |
|---------|----|-------|

1/2" Square Drive Bit Locking Adaptors for 5/16" Hex Screwdriver Bit



**7809HL**



5/16 in



1 7809HL

Spare Part Kit for 8169-1/2 Breaking Bar



**SP120**



75 g



1 SP120

Spare Part Kit for 8170-1/2 Breaking Bar



**SP120XL**



55 g



1 SP120XL

Rail-Clips for 1/2" Sockets/Socket Drivers



**C1/2**



19 mm



25 CLIPS-1/2

1/2" Square Drive Socket Drivers for Slotted Head Screw 60 mm



**7809F**



0.8 mm

1 mm



8 mm

10 mm



5 7809F-8

5 7809F-10

1/2" Square Drive Socket Drivers for Phillips Head Screw 23 mm



**7809PH**



2

3

4



1 7809PH-2

1 7809PH-3

1 7809PH-4

1/2" Square Drive Socket Drivers for Pozidriv Head Screw 60 mm



**7809PZ**



2

3



1 7809PZ-2

1 7809PZ-3

1/2" Square Drive Socket Drivers for TORX® Head Screw



**7809TORX**



T20 1 7809TORX-T20

T25 1 7809TORX-T25

T27 1 7809TORX-T27

T30 1 7809TORX-T30

T40 1 7809TORX-T40

T45 1 7809TORX-T45

T50 1 7809TORX-T50

T55 1 7809TORX-T55

T60 1 7809TORX-T60

T70 10 7809TORX-T70

T20 1 SB7809TORX-T20

T25 1 SB7809TORX-T25

T27 1 SB7809TORX-T27

T30 1 SB7809TORX-T30

T40 1 SB7809TORX-T40

T45 1 SB7809TORX-T45

T50 1 SB7809TORX-T50

T55 1 SB7809TORX-T55

T60 1 SB7809TORX-T60

SB: Retail pack on a plastic info card





1/2" Socket Drivers for TORX® Head Screws



**7809TORX L**

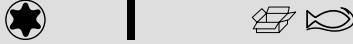

|     |        |   |                  |
|-----|--------|---|------------------|
| T20 | 80 mm  | 1 | 7809TORX-T20-120 |
| T25 | 80 mm  | 1 | 7809TORX-T25-120 |
| T27 | 80 mm  | 1 | 7809TORX-T27-120 |
| T30 | 80 mm  | 1 | 7809TORX-T30-120 |
| T40 | 82 mm  | 1 | 7809TORX-T40-120 |
| T45 | 80 mm  | 1 | 7809TORX-T45-120 |
| T50 | 62 mm  | 1 | 7809TORX-T50-100 |
| T55 | 80 mm  | 1 | 7809TORX-T55-120 |
| T60 | 80 mm  | 1 | 7809TORX-T60-120 |
| T70 | 102 mm | 5 | 7809TORX-T70-140 |

1/2" Square Drive Socket Driver Set for TORX® Head Screw



**7809TO**

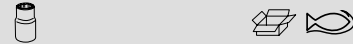

|   |   |        |
|---|---|--------|
| 9 | 1 | 7809TO |
|---|---|--------|

7809TORX-T27, 7809TORX-T20, 7809TORX-T25, 7809TORX-T30, 7809TORX-T50, 7809TORX-T40, 7809TORX-T45, 7809TORX-T60, 7809TORX-T55

1/2" Square Drive Socket Drive Set for Torx® Head Screws - 9 pcs



**7800TORX/9**



|       |   |            |
|-------|---|------------|
| 800 g | 1 | 7800TORX/9 |
|-------|---|------------|

7800TORX-E8, 7800TORX-E10, 7800TORX-E11, 7800TORX-E12, 7800TORX-E14, 7800TORX-E16, 7800TORX-E18, 7800TORX-E20, 7800TORX-E24

1/2" Square Drive Socket Drivers for Hex Head Screw



**7809M**

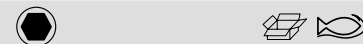

|       |    |            |
|-------|----|------------|
| 4 mm  | 10 | 7809M-4    |
| 5 mm  | 1  | 7809M-5    |
| 6 mm  | 1  | 7809M-6    |
| 7 mm  | 1  | 7809M-7    |
| 8 mm  | 1  | 7809M-8    |
| 9 mm  | 1  | 7809M-9    |
| 10 mm | 1  | 7809M-10   |
| 12 mm | 1  | 7809M-12   |
| 14 mm | 1  | 7809M-14   |
| 17 mm | 1  | 7809M-17   |
| 19 mm | 1  | 7809M-19   |
| 4 mm  | 1  | SB7809M-4  |
| 5 mm  | 1  | SB7809M-5  |
| 6 mm  | 1  | SB7809M-6  |
| 7 mm  | 1  | SB7809M-7  |
| 8 mm  | 1  | SB7809M-8  |
| 9 mm  | 1  | SB7809M-9  |
| 10 mm | 1  | SB7809M-10 |
| 12 mm | 1  | SB7809M-12 |
| 14 mm | 1  | SB7809M-14 |
| 17 mm | 1  | SB7809M-17 |
| 19 mm | 1  | SB7809M-19 |

SB: Retail pack on a plastic info card

1/2" Socket Drivers for Hex Head Screws



**7809M L**

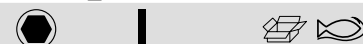

|      |        |   |             |
|------|--------|---|-------------|
| 4 mm | 80 mm  | 1 | 7809M-4-120 |
| 5 mm | 80 mm  | 1 | 7809M-5-120 |
| 5 mm | 143 mm | 1 | 7809M-5-180 |
| 6 mm | 80 mm  | 1 | 7809M-6-120 |

|       |        |    |               |
|-------|--------|----|---------------|
| 7 mm  | 63 mm  | 1  | 7809M-7-100   |
| 8 mm  | 83 mm  | 1  | 7809M-8-120   |
| 10 mm | 80 mm  | 1  | 7809M-10-120  |
| 12 mm | 80 mm  | 1  | 7809M-12-120  |
| 14 mm | 80 mm  | 10 | 7809M-14-120  |
| 17 mm | 80 mm  | 10 | 7809M-17-120  |
| 19 mm | 80 mm  | 8  | 7809M-19-120  |
| 5 mm  | 140 mm | 1  | SB7809M-5-180 |
| 7 mm  | 63 mm  | 1  | SB7809M-7-100 |
| 8 mm  | 81 mm  | 1  | SB7809M-8-120 |

1/2" Square Drive Socket Driver Set for Hex Head Screw



**7808HM**



|   |   |        |
|---|---|--------|
| 8 | 1 | 7808HM |
|---|---|--------|

7809M-4, 7809M-6, 7809M-8, 7809M-7, 7809M-5, 7809M-10, 7809M-12, 7809M-14

1/2" Square Drive Socket Drivers for Imperial Hex Head Screw



**7809Z**



|          |   |             |
|----------|---|-------------|
| 1/4 in   | 1 | 7809Z-3/16  |
| 5/16 in  | 1 | 7809Z-1/4   |
| 3/8 in   | 1 | 7809Z-5/16  |
| 7/16 in  | 1 | 7809Z-3/8   |
| 1/2 in   | 1 | 7809Z-7/16  |
| 17/32 in | 1 | 7809Z-1/2   |
| 9/16 in  | 1 | 7809Z-17/32 |
| 19/32 in | 1 | 7809Z-9/16  |
| 5/8 in   | 1 | 7809Z-19/32 |
| 5/8 in   | 1 | 7809Z-5/8   |

1/2" Square Drive Socket Drivers for Multipoint Head Screw



**7809XZN**

| Size | Quantity | Part Number    |
|------|----------|----------------|
| 6    | 1        | 7809XZN-6      |
| 8    | 1        | 7809XZN-8      |
| 8    | 1        | 7809XZN-8-100  |
| 10   | 1        | 7809XZN-10     |
| 10   | 1        | 7809XZN-10-100 |
| 12   | 1        | 7809XZN-12     |
| 12   | 1        | 7809XZN-12-100 |
| 14   | 1        | 7809XZN-14     |
| 14   | 1        | 7809XZN-14-100 |
| 16   | 1        | 7809XZN-16     |
| 18   | 1        | 7809XZN-18     |

1/2" Round Head Reversible Ratchets with 72 Teeth and 5° Action Angle



**8150RN-1/2**

| Length | Teeth | Quantity | Part Number  |
|--------|-------|----------|--------------|
| 267 mm | 72    | 1        | 8150RN-1/2   |
| 267 mm | 72    | 1        | SB8150RN-1/2 |

SB: With hanging clip

1/2" Reversible Ratchets with 60 Teeth and Dual Pawl



**8195-R**

| Length | Teeth | Quantity | Part Number |
|--------|-------|----------|-------------|
| 260 mm | 60    | 1        | 8195-R      |

1/2" Slim Head Reversible Ratchets with 72 Teeth and 5° Action Angle



**8150SL**

| Length | Teeth | Quantity | Part Number |
|--------|-------|----------|-------------|
| 264 mm | 72    | 1        | 8150SL      |

1/2" Pear Head Reversible Ratchets with 60 Teeth and 6° Action Angle



**SBS81**

| Length | Teeth | Quantity | Part Number |
|--------|-------|----------|-------------|
| 250 mm | 60    | 5        | SBS81       |

Radiator Valve Ratchet Set - 3 Pcs/Plastic Pouch



**8195-SET**

| Dimensions       | Quantity | Part Number |
|------------------|----------|-------------|
| 350 x 20 x 80 mm | 5        | 8195-SET    |

- 8195-R
- 8195-SQ
- 8195-KEY

1/2" Pear Head Reversible Ratchets with 80 Teeth and 4.5° Action Angle



**8150-1/2**

| Length | Teeth | Quantity | Part Number |
|--------|-------|----------|-------------|
| 269 mm | 80    | 1        | 8150-1/2    |
| 269 mm | 80    | 1        | SB8150-1/2  |

SB: With hanging clip

1/2" Swivel Head Ratchets with 72 Teeth and 5° Action Angle



**8120-1/2**

| Length | Teeth | Quantity | Part Number |
|--------|-------|----------|-------------|
| 266 mm | 72    | 12       | 8120-1/2    |

1/2" Flex Head Reversible Ratchets with 32 Teeth and 11.25° Action Angle



**8110H-1/2**

| Length | Teeth | Quantity | Part Number |
|--------|-------|----------|-------------|
| 440 mm | 32    | 1        | 8110H-1/2   |



Fitting Square Drives for 8193-1/2 1/2" Ratchet



**8194-1/2**

|       |   |          |
|-------|---|----------|
|       |   |          |
| 32 mm | 1 | 8194-1/2 |

Fitting Square Drives for 8195-R 1/2" Reversible Ratchet



**8195-SQ**

|         |      |    |         |
|---------|------|----|---------|
|         |      |    |         |
| 37.5 mm | 40 g | 25 | 8195-SQ |

Ratcheting Adaptors with 52 Teeth for 1/2" Ratchet



**8151-1/2**

|       |   |          |
|-------|---|----------|
|       |   |          |
| 71 mm | 1 | 8151-1/2 |

Spare Part Kit for 8150SL 1/2" Ratchet



**8150SL-SPARE**

|    |        |   |              |
|----|--------|---|--------------|
|    |        |   |              |
| 12 | 8150SL | 1 | 8150SL-SPARE |

Spare Part Kit for 8150-1/2 1/2" Ratchet



**8150-1/2-SPARE**

|    |          |   |                |
|----|----------|---|----------------|
|    |          |   |                |
| 11 | 8150-1/2 | 1 | 8150-1/2-SPARE |

Spare Part Kit for 8150RN-1/2 1/2" Ratchet



**8150RN-1/2-SPARE**

|   |            |   |                  |
|---|------------|---|------------------|
|   |            |   |                  |
| 6 | 8150RN-1/2 | 1 | 8150RN-1/2-SPARE |

**3/4"**

3/4" Square Drive Sockets with Metric Hex Profile



**8900SM**

|       |   |           |
|-------|---|-----------|
|       |   |           |
| 19 mm | 1 | 8900SM-19 |
| 22 mm | 1 | 8900SM-22 |
| 23 mm | 1 | 8900SM-23 |
| 24 mm | 5 | 8900SM-24 |
| 26 mm | 5 | 8900SM-26 |
| 27 mm | 5 | 8900SM-27 |
| 28 mm | 1 | 8900SM-28 |
| 29 mm | 1 | 8900SM-29 |
| 30 mm | 5 | 8900SM-30 |
| 32 mm | 5 | 8900SM-32 |
| 33 mm | 1 | 8900SM-33 |
| 34 mm | 1 | 8900SM-34 |
| 35 mm | 1 | 8900SM-35 |
| 36 mm | 5 | 8900SM-36 |
| 38 mm | 1 | 8900SM-38 |
| 41 mm | 5 | 8900SM-41 |
| 42 mm | 1 | 8900SM-42 |
| 46 mm | 1 | 8900SM-46 |
| 50 mm | 1 | 8900SM-50 |
| 55 mm | 1 | 8900SM-55 |
| 60 mm | 1 | 8900SM-60 |

3/4" Square Drive Sockets with Imperial Hex Profile



**8900SZ**

|           |   |               |
|-----------|---|---------------|
|           |   |               |
| 3/4 in    | 1 | 8900SZ-3/4    |
| 13/16 in  | 1 | 8900SZ-13/16  |
| 1 in      | 1 | 8900SZ-1      |
| 1.7/16 in | 1 | 8900SZ-1.7/16 |
| 1.9/16 in | 1 | 8900SZ-1.9/16 |
| 1.7/8 in  | 1 | 8900SZ-1.7/8  |
| 2 in      | 1 | 8900SZ-2      |

3/4" Square Drive Sockets with Metric Bi-Hex Profile



**8900DM**



|       |   |           |
|-------|---|-----------|
| 19 mm | 1 | 8900DM-19 |
| 21 mm | 5 | 8900DM-21 |
| 22 mm | 1 | 8900DM-22 |
| 23 mm | 1 | 8900DM-23 |
| 24 mm | 1 | 8900DM-24 |
| 25 mm | 1 | 8900DM-25 |
| 26 mm | 1 | 8900DM-26 |
| 27 mm | 1 | 8900DM-27 |
| 28 mm | 1 | 8900DM-28 |
| 29 mm | 1 | 8900DM-29 |
| 30 mm | 5 | 8900DM-30 |
| 32 mm | 1 | 8900DM-32 |
| 33 mm | 1 | 8900DM-33 |
| 34 mm | 1 | 8900DM-34 |
| 35 mm | 1 | 8900DM-35 |
| 36 mm | 1 | 8900DM-36 |
| 37 mm | 1 | 8900DM-37 |
| 38 mm | 1 | 8900DM-38 |
| 40 mm | 1 | 8900DM-40 |
| 41 mm | 5 | 8900DM-41 |
| 42 mm | 1 | 8900DM-42 |
| 46 mm | 1 | 8900DM-46 |
| 47 mm | 1 | 8900DM-47 |
| 50 mm | 5 | 8900DM-50 |
| 52 mm | 1 | 8900DM-52 |
| 40 mm | 3 | 8900DM-54 |
| 55 mm | 1 | 8900DM-55 |
| 56 mm | 1 | 8900DM-56 |
| 60 mm | 5 | 8900DM-60 |

|           |   |               |
|-----------|---|---------------|
| 1 7/8 in  | 1 | 8900DZ-1.7/8  |
| 2 in      | 1 | 8900DZ-2      |
| 2.1/16 in | 1 | 8900DZ-2.1/16 |
| 2.1/8 in  | 1 | 8900DZ-2.1/8  |
| 2.3/16 in | 1 | 8900DZ-2.3/16 |
| 2.1/4 in  | 1 | 8900DZ-2.1/4  |
| 2.3/8 in  | 1 | 8900DZ-2.3/8  |

3/4" Square Drive Telescopic Handle with Matte Finish



**8953E-32**



495 to 810 mm 1 8953E-32

3/4" Universal Handles with Nickel and Chrome Finish



**8952N/B**



450 mm 1 8952N/B

3/4" Square Drive Sliding T-Handles



**8954**



390 mm 1 8954-15

3/4" Square Drive Sliding T-Heads



**8954A**



62 mm 1 8954A

3/4" Square Drive Flex Head Breaker Bars



**8957-19**



480 mm 1 8957-19

3/4" Square Drive Flex Heads for 8958 Breaker Bar



**8958A**



125 mm 1 8958A

3/4" Square Drive Flex Heads for 8957 Breaker Bar



**8957A**



140 mm 1 8957A

3/4" Square Drive Sockets with Imperial Bi-Hex Profile



**8900DZ**



|            |   |                |
|------------|---|----------------|
| 3/4 in     | 1 | 8900DZ-3/4     |
| 13/16 in   | 1 | 8900DZ-13/16   |
| 7/8 in     | 1 | 8900DZ-7/8     |
| 15/16 in   | 1 | 8900DZ-15/16   |
| 31/32 in   | 1 | 8900DZ-31/32   |
| 1 in       | 1 | 8900DZ-1       |
| 1 1/16 in  | 1 | 8900DZ-1.1/16  |
| 1 1/8 in   | 1 | 8900DZ-1.1/8   |
| 1 1/4 in   | 1 | 8900DZ-1.1/4   |
| 1 5/16 in  | 5 | 8900DZ-1.5/16  |
| 1 3/8 in   | 1 | 8900DZ-1.3/8   |
| 1 1/2 in   | 1 | 8900DZ-1.1/2   |
| 1.9/16 in  | 1 | 8900DZ-1.9/16  |
| 1 5/8 in   | 1 | 8900DZ-1.5/8   |
| 1.11/16 in | 1 | 8900DZ-1.11/16 |
| 1 3/4 in   | 1 | 8900DZ-1.3/4   |
| 1 13/16 in | 1 | 8900DZ-1.13/16 |

3/4" Square Drive Offset Handles



**8963**



415 mm 1 8963



3/4" Square Drive Extension Bars



**8961/8962**



200 mm 1 8960-8  
400 mm 12 8960-16

3/4" Square Drive to 1" Socket Increasing Adaptors



**9564**



3/4" 1" 1 8972

Round Heads with 72 Teeth for 3/4" Reversible Ratchet



**8950N/A**



170 mm 72 1 8950RN/A

3/4" Square Drive Universal Joints



**8966**



120 mm 1 8966

3/4" Round Head Reversible Ratchets with 72 Teeth and 5° Action Angle



**8950N**



525 mm 72 1 8950RN

Pear Heads with 24 Teeth for 3/4" Reversible Ratchet



**8955N/A**



152 mm 24 1 8955N/A

3/4" Square Drive to 1/2" Socket Decreasing Adaptors



**8965**



3/4" 1/2" 1 8971

3/4" ratchets.



**8955N**



525 mm 24 1 8955N

3/4" Universal handle



**8955N/B**



1160 g 390 mm 5 8955N/B



Ratcheting Adaptors with 72 Teeth for 3/4" Ratchet



**8951**

95.5 mm 1 8951

Spare Part Kit for 8950 N and 8950N/A 3/4" Ratchet



**8950NA-SO/2**

8 8950N, 8950N/A 1 8950NA-SO/2

Spare Part Kit for 8955N and 8955N/A 3/4" Ratchet



**8955N-SPARE**

11 8955N, 8955N/A 1 8955N-SPARE

**1"**

1" Square Drive Sockets with Metric Hex Profile



**9500SM**

- |       |   |           |
|-------|---|-----------|
| 41 mm | 1 | 9500SM-41 |
| 46 mm | 1 | 9500SM-46 |
| 50 mm | 1 | 9500SM-50 |
| 54 mm | 1 | 9500SM-54 |
| 55 mm | 1 | 9500SM-55 |
| 58 mm | 1 | 9500SM-58 |
| 60 mm | 1 | 9500SM-60 |
| 63 mm | 1 | 9500SM-63 |
| 65 mm | 1 | 9500SM-65 |
| 67 mm | 1 | 9500SM-67 |
| 70 mm | 1 | 9500SM-70 |
| 71 mm | 1 | 9500SM-71 |
| 75 mm | 1 | 9500SM-75 |
| 77 mm | 1 | 9500SM-77 |
| 80 mm | 1 | 9500SM-80 |
| 82 mm | 1 | 9500SM-82 |

1" Square Drive Sockets with Imperial Bi-Hex Profile



**9500DZ**

- |            |   |                |
|------------|---|----------------|
| 1.5/8 in   | 1 | 9500DZ-1.5/8   |
| 1.13/16 in | 1 | 9500DZ-1.13/16 |
| 1.7/8 in   | 1 | 9500DZ-1.7/8   |
| 2 in       | 1 | 9500DZ-2       |
| 2.1/8 in   | 1 | 9500DZ-2.1/8   |
| 2.3/16 in  | 1 | 9500DZ-2.3/16  |
| 2.1/4 in   | 1 | 9500DZ-2.1/4   |
| 2.3/8 in   | 1 | 9500DZ-2.3/8   |
| 2.1/2 in   | 1 | 9500DZ-2.1/2   |
| 2.9/16 in  | 1 | 9500DZ-2.9/16  |
| 2.5/8 in   | 1 | 9500DZ-2.5/8   |
| 2.3/4 in   | 1 | 9500DZ-2.3/4   |
| 2.15/16 in | 1 | 9500DZ-2.15/16 |
| 3 in       | 1 | 9500DZ-3       |
| 3.1/8 in   | 1 | 9500DZ-3.1/8   |

1" Square Drive Flex Head Universal Joints with Matte Finish



**9566A**

167 mm 1 9566A

1" Square Drive Sliding T-Handles with Matte Finish



**9555**

508 mm 1 9555

1" Square Drive Sliding T-Heads



**9555AB**

78x78x78 mm 1 9555AB

1" Square Drive Extension Bars with Matte Finish



**9560AB/9563AB**

200 mm 1 9560AB  
440 mm 1 9563AB



1" Square Drive to 3/4" Socket Decreasing Adaptors with Matte Finish



**9565AB**

|      |   |        |
|------|---|--------|
|      |   |        |
| 3/4" | 1 | 9565AB |

1" Round Head Reversible Ratchets with 72 Teeth and 5° Action Angle



**9550N**

|        |    |   |       |
|--------|----|---|-------|
|        |    |   |       |
| 640 mm | 72 | 1 | 9550N |

1" Square Drive Interchangeable Handle Bar for Ratcheting Heads



**9550N/B**

|        |   |         |
|--------|---|---------|
|        |   |         |
| 1960 g | 1 | 9550N/B |

Round Heads with 72 Teeth for 1" Reversible Ratchet



**9550N/A**

|        |    |   |         |
|--------|----|---|---------|
|        |    |   |         |
| 195 mm | 72 | 1 | 9550N/A |

Spare Part Kit for 9550 N and 9550N/A 1" Ratchet



**9550N-SPARE**

|   |                |   |             |
|---|----------------|---|-------------|
|   |                |   |             |
| 2 | 9550N, 9550N/A | 1 | 9550N-SPARE |

**EMPTY SOCKET SET CASES**

Empty Cases with Divider for Socket Set



**-CASE**

|                    |        |   |             |
|--------------------|--------|---|-------------|
|                    |        |   |             |
| 110 x 375 x 430 mm | 2200 g | 1 | S103-CASE   |
| 100 x 215 x 370 mm | 1120 g | 1 | S240AF-CASE |
| 70 x 160 x 280 mm  | 500 g  | 1 | S330-CASE   |
| 110 x 320 x 375 mm | 1620 g | 1 | S400-CASE   |
| 110 x 320 x 375 mm | 1620 g | 1 | S410-CASE   |
| 100 x 215 x 375 mm | 1120 g | 1 | S460-CASE   |
| 100 x 215 x 375 mm | 1120 g | 1 | S560-CASE   |

|                    |        |   |             |
|--------------------|--------|---|-------------|
|                    |        |   |             |
| 110 x 375 x 430 mm | 2200 g | 1 | S81MIX-CASE |
| 110 x 375 x 430 mm | 2200 g | 1 | S108-CASE   |
| 110 x 375 x 430 mm | 2200 g | 1 | SLX17-CASE  |
| 100 x 215 x 375 mm | 1120 g | 1 | S330L-CASE  |

Injected Thin Walled Empty Spare Cases



**4750IB**

|                   |   |              |
|-------------------|---|--------------|
|                   |   |              |
| 35 x 80 x 100 mm  | 1 | SPAR-CASE-A7 |
| 35 x 85 x 160 mm  | 1 | SPAR-CASE-A6 |
| 49 x 152 x 280 mm | 1 | SPAR-CASE-A4 |

**SCAFFOLDING WRENCHES**

Double Metric Bi-Hex Scaffolding Wrench



**SC2RM**

|          |    |             |
|----------|----|-------------|
|          |    |             |
| 13-17 mm | 10 | SC2RM-13-17 |
| 15-17 mm | 10 | SC2RM-15-17 |
| 19-22 mm | 10 | SC2RM-19-22 |
| 27-30 mm | 1  | SC2RM-27-30 |



## Torque Tools



# DIGITAL TORQUE WRENCHES

Digital Torque and Angle Slim Bluetooth® Wrench with Memory and Rectangular Interchangeable Head



## TAWMB MICRO

| mm      | Nm          | Nm       |   |            |
|---------|-------------|----------|---|------------|
| 9x12 mm | 1.5-30 N·m  | 0.01 N·m | 1 | TAWMB930M  |
| 9x12 mm | 6.8-135 N·m | 0.1 N·m  | 1 | TAWMB9135M |

Accuracy: 20% to 100% of full scale

Digital Torque and Angle Bluetooth® Wrench with Memory and Rectangular Interchangeable Head



## TAWMB14\_24

| mm       | Nm           | Nm    |   |            |
|----------|--------------|-------|---|------------|
| 14x18 mm | 17-340 N·m   | 1 N·m | 1 | TAWMB14340 |
| 24x32 mm | 32.5-650 N·m | 1 N·m | 1 | TAWMB24650 |
| 24x32 mm | 40-800 N·m   | 1 N·m | 1 | TAWMB24800 |

Accuracy: 20% to 100% of full scale

Electronic Torque and Angle Slim Wrench with Memory/USB and Fixed Ratchet Head



## TAWM MICRO

| mm     | Nm          | Nm       |   |            |
|--------|-------------|----------|---|------------|
| 1/4 in | 0.6-12 N·m  | 0.01 N·m | 1 | TAWM1412M  |
| 1/4 in | 1.5-30 N·m  | 0.01 N·m | 1 | TAWM1430M  |
| 3/8 in | 6.8-135 N·m | 0.1 N·m  | 1 | TAWM38135M |

Accuracy: 20% to 100% of full scale

Electronic Torque and Angle Slim Wrench with Memory/USB and Rectangular Interchangeable Head



## TAWM9 MICRO

| mm      | Nm          | Nm       |   |           |
|---------|-------------|----------|---|-----------|
| 9x12 mm | 0.6-12 N·m  | 0.01 N·m | 1 | TAWM912M  |
| 9x12 mm | 1.5-30 N·m  | 0.01 N·m | 1 | TAWM930M  |
| 9x12 mm | 6.8-135 N·m | 0.1 N·m  | 1 | TAWM9135M |

Accuracy: 20% to 100% of full scale

Electronic Torque and Angle Wrench with Memory/USB and Fixed Ratchet Head. with memory and USB data download



## TAWM

|        | Nm         | Nm    |   |           |
|--------|------------|-------|---|-----------|
| 3/8 in | 7-135 N·m  | 1 N·m | 1 | TAWM38135 |
| 1/2 in | 17-340 N·m | 1 N·m | 1 | TAWM12340 |
| 3/4 in | 40-800 N·m | 1 N·m | 1 | TAWM34800 |

Accuracy: 20% to 100% of full scale

Electronic Torque and Angle Wrench with Memory/USB and Rectangular Interchangeable Head



## TAWM9\_14\_24

| mm       | Nm         | Nm    |   |           |
|----------|------------|-------|---|-----------|
| 9x12 mm  | 7-135 N·m  | 1 N·m | 1 | TAWM9135  |
| 14x18 mm | 17-340 N·m | 1 N·m | 1 | TAWM14340 |
| 24x32 mm | 40-800 N·m | 1 N·m | 1 | TAWM24800 |

Accuracy: 20% to 100% of full scale

Electronic Torque and Thin Angle Wrench with Fixed Ratchet Head



**TAW MICRO**

| mm     | Nm          | Nm       |   |           |
|--------|-------------|----------|---|-----------|
| 1/4 in | 0.6-12 N·m  | 0.01 N·m | 1 | TAW1412M  |
| 1/4 in | 1.5-30 N·m  | 0.01 N·m | 1 | TAW1430M  |
| 3/8 in | 6.8-135 N·m | 0.1 N·m  | 1 | TAW38135M |

Accuracy: 20% to 100% of full scale

Electronic Torque and Angle Slim Wrench with Rectangular Interchangeable Head



**TAW9 MICRO**

| mm      | Nm          | Nm       |   |          |
|---------|-------------|----------|---|----------|
| 9x12 mm | 0.6-12 N·m  | 0.01 N·m | 1 | TAW912M  |
| 9x12 mm | 1.5-30 N·m  | 0.01 N·m | 1 | TAW930M  |
| 9x12 mm | 6.8-135 N·m | 0.1 N·m  | 1 | TAW9135M |

Accuracy: 20% to 100% of full scale

Electronic Torque and Angle Wrench with Fixed Ratchet Head



**TAW**

| mm     | Nm         | Nm    |   |          |
|--------|------------|-------|---|----------|
| 3/8 in | 7-135 N·m  | 1 N·m | 1 | TAW38135 |
| 1/2 in | 17-340 N·m | 1 N·m | 1 | TAW12340 |
| 3/4 in | 40-800 N·m | 1 N·m | 1 | TAW34800 |

Accuracy: 20% to 100% of full scale

Electronic Torque and Angle Wrench with Rectangular Interchangeable Head



**TAW9 14 24**

| mm       | Nm         | Nm    |   |          |
|----------|------------|-------|---|----------|
| 9x12 mm  | 7-135 N·m  | 1 N·m | 1 | TAW9135  |
| 14x18 mm | 17-340 N·m | 1 N·m | 1 | TAW14340 |
| 24x32 mm | 40-800 N·m | 1 N·m | 1 | TAW24800 |

Accuracy: 20% to 100% of full scale

Electronic Torque Wrench with Rectangular Interchangeable Head



**IZO-D**

| mm     | Nm           | Nm      |   |           |
|--------|--------------|---------|---|-----------|
| 1/4 in | 3-30 N·m     | 0.1 N·m | 1 | IZO-D-30  |
| 3/8 in | 13.5-135 N·m | 1 N·m   | 1 | IZO-D-135 |
| 1/2 in | 20-200 N·m   | 1 N·m   | 1 | IZO-D-200 |
| 1/2 in | 34-340 N·m   | 1 N·m   | 1 | IZO-D-340 |

Electronic Torque Wrench with Fixed Ratchet Head. ring spanner



**IZO-DR**

| mm     | Nm         | Nm    |   |            |
|--------|------------|-------|---|------------|
| 3/4 in | 81-810 N·m | 1 N·m | 1 | IZO-DR-810 |





## MECHANICAL TORQUE WRENCHES

Mechanical Adjustable Torque Click Wrench with Window Scale and Fixed Ratchet Head

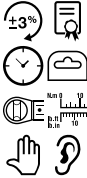

### 74WR-15/74WR-25

| mm     | Nm       | Nm      |   |         |
|--------|----------|---------|---|---------|
| 1/4 in | 3-15 N·m | 0.1 N·m | 1 | 74WR-15 |
| 1/4 in | 5-25 N·m | 0.2 N·m | 1 | 74WR-25 |

Mechanical Adjustable Torque Click Wrench with Window Scale and Fixed Push-Through Ratchet Head



### 74WR-50/74WR-400

| mm   | Nm         | Nm      |   |           |
|------|------------|---------|---|-----------|
| 3/8" | 10-50 N·m  | 0.5 N·m | 1 | 74WR-50   |
| 3/8" | 20-100 N·m | 1 N·m   | 1 | 74WR-100B |
| 1/2" | 20-100 N·m | 1 N·m   | 1 | 74WR-100  |
| 1/2" | 40-200 N·m | 2 N·m   | 1 | 74WR-200  |
| 1/2" | 60-300 N·m | 2 N·m   | 1 | 74WR-300  |
| 1/2" | 60-340 N·m | 5 N·m   | 1 | 74WR-340  |
| 3/4" | 80-400 N·m | 5 N·m   | 1 | 74WR-400  |

Mechanical Adjustable Torque Click Wrench with Window Scale and Rectangular Interchangeable Head



### 74W9/74W14

| mm      | Nm        | Nm      |   |         |
|---------|-----------|---------|---|---------|
| 9x12 mm | 3-15 N·m  | 0.2 N·m | 1 | 74W9-15 |
| 9x12 mm | 5-25 N·m  | 0.2 N·m | 1 | 74W9-25 |
| 9x12 mm | 10-50 N·m | 0.5 N·m | 1 | 74W9-50 |

| mm       | Nm         | Nm    |   |           |
|----------|------------|-------|---|-----------|
| 9x12 mm  | 20-100 N·m | 1 N·m | 1 | 74W9-100  |
| 9x12 mm  | 40-200 N·m | 1 N·m | 1 | 74W9-200  |
| 14x18 mm | 40-200 N·m | 2 N·m | 1 | 74W14-200 |
| 14x18 mm | 60-300 N·m | 2 N·m | 1 | 74W14-300 |
| 14x18 mm | 80-400 N·m | 5 N·m | 1 | 74W14-400 |

Mechanical Adjustable Torque Click Wrench with Window Scale and Spigot Interchangeable Head

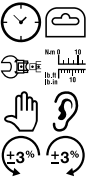

### 74WS-15/74WS-300

| mm    | Nm         | Nm      |   |          |
|-------|------------|---------|---|----------|
| 16 mm | 3-15 N·m   | 0.2 N·m | 1 | 74WS-15  |
| 16 mm | 5-25 N·m   | 0.2 N·m | 1 | 74WS-25  |
| 16 mm | 10-50 N·m  | 0.5 N·m | 1 | 74WS-50  |
| 16 mm | 20-100 N·m | 1 N·m   | 1 | 74WS-100 |
| 16 mm | 40-200 N·m | 2 N·m   | 1 | 74WS-200 |
| 16 mm | 60-300 N·m | 2 N·m   | 1 | 74WS-300 |

Mechanical Adjustable Torque Click Wrench with Marked Scale and Fixed Ratchet Head

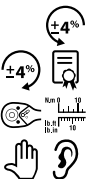

### 7455

| mm     | Nm           | Nm       |   |           |
|--------|--------------|----------|---|-----------|
| 1/4 in | 1-5 N·m      | 0.05 N·m | 1 | 7455-5    |
| 1/4 in | 3-15 N·m     | 0.1 N·m  | 1 | 7455-15   |
| 1/4 in | 4-20 N·m     | 0.1 N·m  | 1 | 7455-20   |
| 1/4 in | 5-25 N·m     | 0.1 N·m  | 1 | 7455-25   |
| 3/8 in | 12-60 N·m    | 0.5 N·m  | 1 | 7455-60   |
| 3/8 in | 20-100 N·m   | 0.5 N·m  | 1 | 7455-100  |
| 1/2 in | 20-100 N·m   | 0.5 N·m  | 1 | 7455-100A |
| 1/2 in | 40-200 N·m   | 2 N·m    | 1 | 7455-200  |
| 1/2 in | 60-300 N·m   | 2 N·m    | 1 | 7455-300  |
| 1/2 in | 68-340 N·m   | 2 N·m    | 1 | 7455-340  |
| 3/4 in | 100-500 N·m  | 5 N·m    | 1 | 7455-500  |
| 3/4 in | 160-800 N·m  | 5 N·m    | 1 | 7455-800  |
| 1 in   | 200-1000 N·m | 10 N·m   | 1 | 7455-1000 |

Mechanical Adjustable Torque Click Wrench with Marked Scale, Fixed Ratchet Head and 2 Section Handle

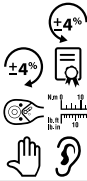

**7455-1500**

|      |              |        |   |           |
|------|--------------|--------|---|-----------|
|      |              |        |   |           |
| 1 in | 300-1500 N·m | 10 N·m | 1 | 7455-1500 |

Mechanical Adjustable Torque Click Wrench with Marked Scale, Interchangeable Head and 2 Sections Handle

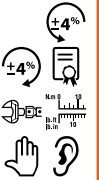

**7465-1500**

|          |              |        |   |           |
|----------|--------------|--------|---|-----------|
|          |              |        |   |           |
| 27x36 mm | 300-1500 N·m | 10 N·m | 1 | 7465-1500 |

Mechanical Adjustable Torque Click Wrench with Marked Scale and Fixed Square Drive Head



**7455-2500**

|      |              |        |   |           |
|------|--------------|--------|---|-----------|
|      |              |        |   |           |
| 1 in | 500-2500 N·m | 10 N·m | 1 | 7455-2500 |

Mechanical Adjustable Torque Click Wrench with Marked Scale and Flex Ratchet Head



**7456**

|        |              |            |   |           |
|--------|--------------|------------|---|-----------|
|        |              |            |   |           |
| 3/8 in | 10-80 lbf·ft | 0.5 lbf·ft | 1 | 7456-80LB |

Mechanical Adjustable Torque Click Wrench with Marked Scale and Interchangeable Head

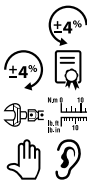

**7465**

|          |             |          |   |          |
|----------|-------------|----------|---|----------|
|          |             |          |   |          |
| 9x12 mm  | 1-5 N·m     | 0.05 N·m | 1 | 7465-5   |
| 9x12 mm  | 3-15 N·m    | 0.1 N·m  | 1 | 7465-15  |
| 9x12 mm  | 6-30 N·m    | 0.1 N·m  | 1 | 7465-30  |
| 9x12 mm  | 12-60 N·m   | 0.5 N·m  | 1 | 7465-60  |
| 9x12 mm  | 20-100 N·m  | 0.5 N·m  | 1 | 7465-100 |
| 14x18 mm | 40-200 N·m  | 2 N·m    | 1 | 7465-200 |
| 14x18 mm | 68-340 N·m  | 2 N·m    | 1 | 7465-340 |
| 24x32 mm | 160-800 N·m | 5 N·m    | 1 | 7465-800 |

Mechanical Adjustable Free Hand Point Torque Click Wrench with Fixed Ratchet Head



**75R3/75R1**

|         |              |        |   |           |
|---------|--------------|--------|---|-----------|
|         |              |        |   |           |
| 3/4" in | 130-650 N·m  | 5 N·m  | 1 | 75R3-650  |
| 3/4" in | 200-800 N·m  | 10 N·m | 1 | 75R3-800  |
| 3/4" in | 300-1000 N·m | 10 N·m | 1 | 75R3-1000 |
| 1" in   | 500-1500 N·m | 10 N·m | 1 | 75R1-1500 |



Mechanical Adjustable Free Hand Point Torque Click Wrench with Spigot Interchangeable Head



**75S-650**

|       |             |       |   |         |
|-------|-------------|-------|---|---------|
|       |             |       |   |         |
| 22 mm | 130-650 N·m | 5 N·m | 1 | 75S-650 |

Mechanical Adjustable Breaking Torque Wrench with Fixed Ratchet Head and Double Adjusting Bar



**76R1-2000**

|      |              |        |   |           |
|------|--------------|--------|---|-----------|
|      |              |        |   |           |
| 1 in | 900-2000 N·m | 50 N·m | 1 | 76R1-2000 |

Mechanical Adjustable Window Scale Breaking Torque Wrench with Fixed Ratchet Head

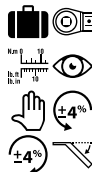

**76R3**

|          |              |        |   |           |
|----------|--------------|--------|---|-----------|
|          |              |        |   |           |
| 3/4-1 in | 120-600 N·m  | 10 N·m | 1 | 76R3-600  |
| 3/4-1 in | 200-800 N·m  | 10 N·m | 1 | 76R3-800  |
| 3/4-1 in | 300-1000 N·m | 20 N·m | 1 | 76R3-1000 |

Mechanical Adjustable Window Scale Breaking Torque Click Wrench with Spigot Interchangeable Head

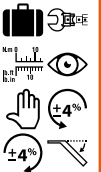

**76S-600**

|       |             |        |   |         |
|-------|-------------|--------|---|---------|
|       |             |        |   |         |
| 22 mm | 120-600 N·m | 10 N·m | 1 | 76S-600 |

Mechanical Adjustable Breaking Torque Wrench with Fixed Ratchet Head



**76R3-1500**

|        |              |        |   |           |
|--------|--------------|--------|---|-----------|
|        |              |        |   |           |
| 3/4 in | 700-1500 N·m | 25 N·m | 1 | 76R3-1500 |

Mechanical Torque Wrench with Dial Scale, Fixed Square Drive Head & Metal Handle

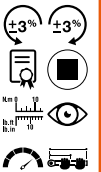

**7454 M**

|        |              |         |   |           |
|--------|--------------|---------|---|-----------|
|        |              |         |   |           |
| 1/4 in | 0.7-3.5 N·m  | 0.1 N·m | 1 | 7454-3.5  |
| 1/4 in | 1.68-8.4 N·m | 0.2 N·m | 1 | 7454-8.4  |
| 3/8 in | 3.4-17 N·m   | 0.5 N·m | 1 | 7454-17   |
| 3/8 in | 6.4-32 N·m   | 0.5 N·m | 1 | 7454-32   |
| 3/8 in | 14-70 N·m    | 1 N·m   | 1 | 7454-70A  |
| 1/2 in | 28-140 N·m   | 5 N·m   | 1 | 7454-140A |
| 1/2 in | 46-230 N·m   | 10 N·m  | 1 | 7454-230  |
|        | 160-800 N·m  | 20 N·m  | 1 | 7454-800A |

Mechanical Torque Wrench with Dial Scale, Fixed Square Drive Head and Metal Handle

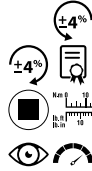

**7454-480/7454-800**

|        |             |        |  |   |          |
|--------|-------------|--------|--|---|----------|
|        |             |        |  |   |          |
| 3/4 in | 100-480 N·m | 10 N·m |  | 1 | 7454-480 |

Mechanical Torque Wrench with Dial Scale, Fixed Square Drive Head and 2 Sections Handle

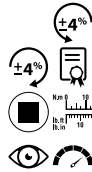

**7454-1400**

|      |              |        |  |   |           |
|------|--------------|--------|--|---|-----------|
|      |              |        |  |   |           |
| 1 in | 275-1400 N·m | 25 N·m |  | 1 | 7454-1400 |

Mechanical Torque Wrench with Dial Scale/LED and Fixed Square Drive Head



**7454-800E**

|        |             |        |  |   |           |
|--------|-------------|--------|--|---|-----------|
|        |             |        |  |   |           |
| 3/4 in | 160-800 N·m | 20 N·m |  | 1 | 7454-800E |

Mechanical Torque Wrench with Dial Scale/LED and Fixed Square Drive Head and 2 Sections Handle



**7454-1400E**

|      |              |        |  |   |            |
|------|--------------|--------|--|---|------------|
|      |              |        |  |   |            |
| 1 in | 275-1400 N·m | 25 N·m |  | 1 | 7454-1400E |

Mechanical Preset Torque Click Wrench with Fixed Ratchet Head



**74PR-20**

|        |          |        |   |         |
|--------|----------|--------|---|---------|
|        |          |        |   |         |
| 1/4 in | 4-20 N·m | 219 mm | 1 | 74PR-20 |

Mechanical Preset Torque Click Wrench with Fixed Push-Through Ratchet Head



**74PR-60/74PR-400**

|        |            |        |   |           |
|--------|------------|--------|---|-----------|
|        |            |        |   |           |
| 3/8 in | 12-60 N·m  | 295 mm | 1 | 74PR-60   |
| 1/2 in | 12-60 N·m  | 301 mm | 1 | 74PR-60A  |
| 3/8 in | 20-100 N·m | 335 mm | 1 | 74PR-100  |
| 1/2 in | 20-100 N·m | 342 mm | 1 | 74PR-100A |
| 1/2 in | 40-200 N·m | 425 mm | 1 | 74PR-200  |
| 1/2 in | 60-300 N·m | 668 mm | 1 | 74PR-300  |
| 3/4 in | 80-400 N·m | 675 mm | 1 | 74PR-400  |



Mechanical Preset Torque Click Wrench with Rectangular Interchangeable Head and Plastic Handle



**74P9-20**

| mm      | Nm       | L      |           |
|---------|----------|--------|-----------|
| 9x12 mm | 4-20 N·m | 205 mm | 1 74P9-20 |

Mechanical Preset Torque Click Wrench with Spigot Interchangeable Head and Rubber Handle

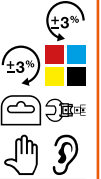

**74PS-60/74PS-300**

| mm    | Nm         | L      |            |
|-------|------------|--------|------------|
| 16 mm | 12-60 N·m  | 283 mm | 1 74PS-60  |
| 16 mm | 20-100 N·m | 324 mm | 1 74PS-100 |
| 16 mm | 40-200 N·m | 405 mm | 1 74PS-200 |
| 16 mm | 60-300 N·m | 643 mm | 1 74PS-300 |

Mechanical Preset Torque Click Wrench with Rectangular Interchangeable Head and Rubber Handle



**74P9-60/74P14-400**

| mm       | Nm         | L      |             |
|----------|------------|--------|-------------|
| 9x12 mm  | 12-60 N·m  | 286 mm | 1 74P9-60   |
| 9x12 mm  | 20-100 N·m | 326 mm | 1 74P9-100  |
| 14x18 mm | 40-200 N·m | 403 mm | 1 74P14-200 |
| 14x18 mm | 60-300 N·m | 534 mm | 1 74P14-300 |
| 14x18 mm | 80-400 N·m | 652 mm | 1 74P14-400 |

Mechanical Preset Free Hand Point Torque Click Wrench with Fixed Ratchet Head



**75P3/75P1**

| mm      | Nm           | L       |             |
|---------|--------------|---------|-------------|
| 3/4 in  | 130-650 N·m  | 848 mm  | 1 75P3-650  |
| 3/4" in | 200-800 N·m  | 1030 mm | 1 75P3-800  |
| 3/4" in | 300-1000 N·m | 1238 mm | 1 75P3-1000 |
| 1" in   | 500-1500 N·m | 1563 mm | 1 75P1-1500 |

Mechanical Preset Torque Click Wrench with Spigot Interchangeable Head and Plastic Handle

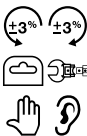

**74PS-20**

| mm    | Nm       | L      |           |
|-------|----------|--------|-----------|
| 16 mm | 4-20 N·m | 206 mm | 1 74PS-20 |

Mechanical Preset Free Hand Point Torque Click Wrench with Spigot Interchangeable Head



**75PS-650**

| mm    | Nm          | L      |            |
|-------|-------------|--------|------------|
| 22 mm | 130-650 N·m | 800 mm | 1 75PS-650 |



### Handle Extension for 75 Series Torque Click Wrench



#### 75EXT

|        |       |          |   |       |
|--------|-------|----------|---|-------|
|        |       |          |   |       |
| 700 mm | 60 mm | 1.600 kg | 1 | 75EXT |

## TORQUE SCREWDRIVERS

### Digital Torque and Angle Bluetooth® Screwdriver



#### TASMB14H

|        |              |          |   |             |
|--------|--------------|----------|---|-------------|
|        |              |          |   |             |
| 1/4 in | 0.04-0.7 N·m | 0.01 N·m | 1 | TASMB14H007 |
| 1/4 in | 0.45-9 N·m   | 0.01 N·m | 1 | TASMB14H09  |

Accuracy: 20% to 100% of full scale

### Digital Torque & Angle Screwdriver with Memory & USB



#### TASM14H

|        |                 |   |            |
|--------|-----------------|---|------------|
|        |                 |   |            |
| 1/4 in | 0.035-0.700 N·m | 1 | TASM14H007 |
| 1/4 in | 0.45-9 N·m      | 1 | TASM14H09  |

### Electronic Torque and Angle Screwdriver



#### TAS14

|         |         |              |   |           |
|---------|---------|--------------|---|-----------|
|         |         |              |   |           |
| 1/4" in |         | 0.04-0.7 N·m | 1 | TAS14H007 |
| - in    | 1/4" in | 0.04-0.7 N·m | 1 | TAS14S007 |
| 1/4" in |         | 0.45-9 N·m   | 1 | TAS14H09  |
|         | 1/4" in | 0.45-9 N·m   | 1 | TAS14S09  |

Accuracy: 20% to 100% of full scale

### Adjustable Torque Screwdriver with Window Scale



#### 6973N-6978N

|        |            |       |   |       |
|--------|------------|-------|---|-------|
|        |            |       |   |       |
| 1/4 in | 16-80 cNm  | 1 cNm | 1 | 6973N |
| 1/4 in | 40-200 cNm | 2 cNm | 1 | 6976N |
| 1/4 in | 90-450 cNm | 5 cNm | 1 | 6978N |

### Adjustable Torque Mini Wrench with Fixed Screwdriver Bit



#### 6852-5

|        |         |         |   |        |
|--------|---------|---------|---|--------|
|        |         |         |   |        |
| 1/4 in | 1-5 N·m | 0.1 N·m | 1 | 6852-5 |



Adjustable Torque Mini Wrench Set with Fixed Screwdriver Bit



**6852-5/S17**

|                  |         |   |            |
|------------------|---------|---|------------|
|                  |         |   |            |
| 32 x 70 x 200 mm | 0.29 kg | 1 | 6852-5/S17 |

Preset Torque Screwdriver with 1/4" Hex Bit Holder



**6873N-6880N**

|            |        |        |   |       |
|------------|--------|--------|---|-------|
|            |        |        |   |       |
| 7-70 cNm   | 1/4 in | 1/4 in | 1 | 6876N |
| 15-170 cNm | 1/4 in | 1/4 in | 1 | 6878N |
| 45-450 cNm | 1/4 in | 1/4 in | 1 | 6880N |

**KM653-QR-1P**

|                          |  |  |
|--------------------------|--|--|
| 6852-5                   |  |  |
| 6700SM-4                 |  |  |
| 59S/PH0, 59S/PH1         |  |  |
| 59S/PZ0, 59S/PZ1         |  |  |
| 59S/H1.5                 |  |  |
| 59S/0.8-5.5, 59S/0.6-4.5 |  |  |
| 59S/T6, 59S/T7, 59S/T8   |  |  |

Adjustable Torque Screwdriver with Marked Scale in cN·m



**TSS120**

|        |            |       |   |        |
|--------|------------|-------|---|--------|
|        |            |       |   |        |
| 1/4 in | 10-120 cNm | 1 cNm | 1 | TSS120 |

Adjustable Torque Screwdriver with Marked Scale in N·m



**TSS600**

|        |         |         |   |        |
|--------|---------|---------|---|--------|
|        |         |         |   |        |
| 1/4 in | 1-6 N·m | 0.1 N·m | 1 | TSS600 |

Preset Torque Mini Wrench with Fixed Screwdriver Bit



**6852P-5**

|         |         |        |   |         |
|---------|---------|--------|---|---------|
|         |         |        |   |         |
| 1/4" in | 1-5 N·m | 157 mm | 1 | 6852P-5 |

Fixed Preset ERGO™ Torque Screwdriver. With TORX® and TORX Plus® blades



**BE-6990**

|         |     |      |   |              |
|---------|-----|------|---|--------------|
|         |     |      |   |              |
| 0.6 N·m | T6  | IP6  | 1 | BE-6990-IP6  |
| 0.9 N·m | T7  | IP7  | 1 | BE-6990-IP7  |
| 1.2 N·m | T8  | IP8  | 1 | BE-6990-IP8  |
| 1.4 N·m | T9  | IP9  | 1 | BE-6990-IP9  |
| 2 N·m   | T10 | IP10 | 1 | BE-6990-IP10 |
| 3 N·m   | T15 | IP15 | 1 | BE-6990-IP15 |

Fixed Preset ERGO™ Torque Screwdriver Set



**BE-6990-IPSET**

|                   |          |   |               |
|-------------------|----------|---|---------------|
|                   |          |   |               |
| 40 x 170 x 215 mm | 0.755 kg | 1 | BE-6990-IPSET |

BE-6990-IP7, BE-6990-IP8, BE-6990-IP9, BE-6990-IP15

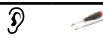

Torque Screwdriver Blades with TORX® Tip



**BE-6990TX-KL**



| T6  | 1.70 mm | 160 mm | 10 | BE-6990TX-T6-KL |
|-----|---------|--------|----|-----------------|
| T7  | 1.99 mm | 160 mm | 10 | BE-6990TX-T7-KL |
| T8  | 2.31 mm | 160 mm | 10 | BE-6990TX-T8-KL |
| T9  | 2.50 mm | 170 mm | 10 | BE-6990TX-T9-KL |
| T10 | 2.74 mm | 170 mm | 10 | BE-6990TX-T10KL |
| T15 | 3.27 mm | 170 mm | 10 | BE-6990TX-T15KL |

Torque Screwdriver Blades with TORX PLUS® Tip



**BE-6990-IP-KL**



| IP6  | 1.50 mm | 170 mm | 10 | BE-6990-IP6-KL  |
|------|---------|--------|----|-----------------|
| IP7  | 1.99 mm | 170 mm | 10 | BE-6990-IP7-KL  |
| IP8  | 2.31 mm | 170 mm | 10 | BE-6990-IP8-KL  |
| IP9  | 2.50 mm | 170 mm | 10 | BE-6990-IP9-KL  |
| IP10 | 2.74 mm | 170 mm | 10 | BE-6990-IP10-KL |
| IP15 | 3.27 mm | 170 mm | 10 | BE-6990-IP15-KL |

Spare blade for TORX® head screws



**BE-6990-IP20-KL**

| IP20 | 4.5 mm | 90 mm | 10 | BE-6990-IP20-KL |
|------|--------|-------|----|-----------------|

Spare blade for TORX® head screws



**BE-6990TX-T20KL**

| T20 | 4.5 mm | 92 mm | 10 | BE-6990TX-T20KL |
|-----|--------|-------|----|-----------------|

**MULTIPLIERS**

Hand Torque Multiplier with Offset and Straight Reaction Arms



**89049TM-1000**

| 1000 Nm - 3/4 in | 4.8:1/4.9:1* | 208/204 Nm - 1/2 in |  | 1 | 89049TM-1000 |
|------------------|--------------|---------------------|--|---|--------------|



### Hand Torque Multiplier with Offset and Straight Reaction Arms



#### 8905-TM/9505-TM

| in               | Ratio | in              | Icons     |
|------------------|-------|-----------------|-----------|
| 1300 Nm - 3/4 in | 5:1   | 260 Nm - 1/2 in | 1 8905-TM |
| 2700 Nm - 1 in   | 5:1   | 540 Nm - 3/4 in | 1 9505-TM |

### Hand Torque Multiplier with Reaction Plate



#### 9505

| in             | Ratio | in              | Icons       |
|----------------|-------|-----------------|-------------|
| 3400 Nm - 1 in | 5:1   | 680 Nm - 3/4 in | 1 9505-3400 |

### Hand Torque Multiplier with Reaction Plate and Ratcheting Locking System



#### 9525-9625

| in                 | Ratio | in              | Icons       |
|--------------------|-------|-----------------|-------------|
| 3400 Nm - 1 in     | 25:1  | 136 Nm - 1/2 in | 1 9525-3400 |
| 9500 Nm - 1.1/2 in | 25:1  | 380 Nm - 3/4 in | 1 9625-9500 |

### Hand Torque Multiplier with Straight Reaction Arm



#### 95155B/9526B

| in             | Ratio  | in              | Icons         |
|----------------|--------|-----------------|---------------|
| 3000 Nm - 1 in | 15.5:1 | 193 Nm - 1/2 in | 1 95155B-3000 |
| 4500 Nm - 1 in | 26:1   | 173 Nm - 1/2 in | 1 9526B-4500  |

### Compact Hand Torque Multiplier with Offset Reaction Arm



#### 89222CR/96255CR

| in                 | Ratio  | in              | Icons          |
|--------------------|--------|-----------------|----------------|
| 1000 Nm - 3/4 in   | 22.2:1 | 45 Nm - 1/2 in  | 1 89222CR-1000 |
| 2000 Nm - 1 in     | 27:1   | 74 Nm - 1/2 in  | 1 9527CR-2000  |
| 4000 Nm - 1 in     | 25:1   | 160 Nm - 1/2 in | 1 9525CR-4000  |
| 7000 Nm - 1.1/2 in | 25.5:1 | 274 Nm - 1/2 in | 1 96255CR-7000 |

## TORQUE TESTERS

### Multifunctional Testers for torque screwdrivers and wrenches



#### TEA003-TEA030

| Nm          | in     | Nm       | Icons     |
|-------------|--------|----------|-----------|
| 0.1-3.0 N·m | 1/4 in | 0.01 N·m | 1 TEA003  |
| 0.5-10 N·m  | 1/4 in | 0.01 N·m | 1 TEA010  |
| 1.5-30 N·m  | 10 mm  | 0.1 N·m  | 1 TEA030  |
| 1.5-30 N·m  | 10 mm  | 0.1 N·m  | 1 TEA030A |

### Joint Simulators for Torque Testing Equipment



#### TJS

| max    | in     | mm    | Icons    |
|--------|--------|-------|----------|
| 3 N·m  | 1/4 in | 31 mm | 1 TJS003 |
| 10 N·m | 1/4 in | 31 mm | 1 TJS010 |
| 30 N·m | 1/4 in | 31 mm | 1 TJS030 |

Multifunctional tester for torque wrenches



**TEA065-TEA2100**

| mm           |       | in     |  |   |         |
|--------------|-------|--------|--|---|---------|
| 3-65 N·m     | - mm  | 3/8 in |  | 1 | TEA065  |
| 10-350 N·m   | - mm  | 1/2 in |  | 1 | TEA350  |
| 50-1100 N·m  | 27 mm | 3/4 in |  | 1 | TEA1100 |
| 200-2100 N·m | 27 mm |        |  | 1 | TEA2100 |

**TORQUE ANGLE ADAPTORS**

Electronic Torque and Angle Meter



**TAM**

| mm     |             |   |          |  |  |
|--------|-------------|---|----------|--|--|
| 1/4 in | 1,5-30 N·m  | 1 | TAM1430  |  |  |
| 3/8 in | 6,8-135 N·m | 1 | TAM38135 |  |  |
| 1/2 in | 6,8-135 N·m | 1 | TAM12135 |  |  |
| 1/2 in | 10-200 N·m  | 1 | TAM12200 |  |  |
| 1/2 in | 17-340 N·m  | 1 | TAM12340 |  |  |

Electronic Angle Meter



**MAM**

| 0-360° | 56 mm | 1 | MAM50M |  |  |
|--------|-------|---|--------|--|--|

Angle Meter with Magnet



**7851-M/8951-M**

| 1/2 in | 0-360 | 490 mm | 1 | 7851-M |  |
|--------|-------|--------|---|--------|--|
| 3/4 in | 0-360 | 490 mm | 1 | 8951-M |  |

Angle Meter with Clamp



**7851-G**

| 1/2 in | 0-360 | 555 mm | 1 | 7851-G |  |
|--------|-------|--------|---|--------|--|

**INSERT TOOLS**

Round Ratchet Head with Rectangular Connector



**9/14/24/27R**





|        |          | mm       |   | max     |  |  |  |
|--------|----------|----------|---|---------|--|--|--|
| 1/4 in | 9x12 mm  | 30 N·m   | 1 | 9R-1/4  |  |  |  |
| 3/8 in | 9x12 mm  | 135 N·m  | 1 | 9R-3/8  |  |  |  |
| 1/2 in | 9x12 mm  | 160 N·m  | 1 | 9R-1/2  |  |  |  |
| 1/2 in | 14x18 mm | 340 N·m  | 1 | 14R-1/2 |  |  |  |
| 3/4 in | 14x18 mm | 420 N·m  | 1 | 14R-3/4 |  |  |  |
| 3/4 in | 24x32 mm | 1000 N·m | 1 | 24R-3/4 |  |  |  |
| 1 in   | 24x32 mm | 1200 N·m | 1 | 24R-1   |  |  |  |
| 1 in   | 27x36 mm | 2500 N·m | 1 | 27R-1   |  |  |  |









Push-Through Square Ratchet Head with Rectangular Connector



|        |  |  |  |  |  |
|--------|---|--|---|---|---|
| 1/2 in |   | 9x12 mm  | 160 N·m   | 1   | 9P-1/2  |
| 1/2 in |   | 14x18 mm   | 340 N·m   | 1   | 14P-1/2   |





9/14/24/27T

|        |  |  |  |  |  |
|--------|--|---|---|---|---|
| 1/4 in |  | 9x12 mm   | 30 N·m  | 1   | 9T-1/4  |
| 3/8 in |  | 9x12 mm   | 135 N·m   | 1   | 9T-3/8  |
| 1/2 in |  | 9x12 mm   | 160 N·m   | 1   | 9T-1/2  |
| 1/2 in |  | 14x18 mm  | 340 N·m   | 1   | 14T-1/2   |
| 3/4 in |  | 14x18 mm  | 420 N·m   | 1   | 14T-3/4   |
| 3/4 in |  | 24x32 mm  | 1000 N·m  | 1   | 24T-3/4   |
| 1 in   |  | 24x32 mm  | 1200 N·m  | 1   | 24T-1   |
| 1 in   |  | 27x36 mm  | 2500 N·m  | 1   | 27T-1   |

Fixed Square Head with Rectangular Connector



9/14/24/27F

|        |  |  |  |  |  |
|--------|--|---|---|---|---|
| 1/4 in |  | 9x12 mm   | 30 N·m  | 1   | 9F-1/4  |
| 3/8 in |  | 9x12 mm   | 135 N·m   | 1   | 9F-3/8  |
| 1/2 in |  | 9x12 mm   | 160 N·m   | 1   | 9F-1/2  |
| 1/2 in |  | 14x18 mm  | 340 N·m   | 1   | 14F-1/2   |
| 3/4 in |  | 14x18 mm  | 420 N·m   | 1   | 14F-3/4   |
| 3/4 in |  | 24x32 mm  | 1000 N·m  | 1   | 24F-3/4   |
| 1 in   |  | 24x32 mm  | 1200 N·m  | 1   | 24F-1   |
| 1 in   |  | 27x36 mm  | 2500 N·m  | 1   | 27F-1   |

Pear Ratchet Head with Rectangular Connector







9/14P

|        |  |  |  |  |  |
|--------|--|---|---|---|---|
| 1/4 in |  | 9x12 mm   | 30 N·m  | 1   | 9P-1/4  |
| 3/8 in |  | 9x12 mm   | 135 N·m   | 1   | 9P-3/8  |

Pear Ratchet Head with Quick-Release and Rectangular Connector







9/14Q

|        |  |  |  |  |  |
|--------|--|---|--|--|--|
| 1/4 in |  | 9x12 mm   | 30 N·m   | 1  | 9Q-1/4   |
| 3/8 in |  | 9x12 mm   | 135 N·m  | 1  | 9Q-3/8   |
| 1/2 in |  | 9x12 mm   | 160 N·m  | 1  | 9Q-1/2   |
| 1/2 in |  | 14x18 mm  | 340 N·m  | 1  | 14Q-1/2  |

Ratchet Head for Screwdriver Bits with Rectangular Connector







9B





|         |  |  |  |  |
|---------|---|---|---|---|
| 1/4 in  |   | 9x12 mm   | 1   | 9B-1/4  |
| 5/16 in |   | 9x12 mm   | 1   | 9B-5/16   |

## Open-End Metric Wrench with Rectangular Connector



### 9/14/24/277

|  |  |  |  |  |
|--|---|---|---|---|
| 7 mm   | 9x12 mm   | 9 N·m   | 1   | 97-7  |
| 8 mm   | 9x12 mm   | 13 N·m  | 1   | 97-8  |
| 9 mm   | 9x12 mm   | 18 N·m  | 1   | 97-9  |
| 10 mm  | 9x12 mm   | 24 N·m  | 1   | 97-10   |
| 11 mm  | 9x12 mm   | 32 N·m  | 1   | 97-11   |
| 12 mm  | 9x12 mm   | 41 N·m  | 1   | 97-12   |
| 13 mm  | 9x12 mm   | 51 N·m  | 1   | 97-13   |
| 14 mm  | 9x12 mm   | 63 N·m  | 1   | 97-14   |
| 15 mm  | 9x12 mm   | 77 N·m  | 1   | 97-15   |
| 16 mm  | 9x12 mm   | 92 N·m  | 1   | 97-16   |
| 17 mm  | 9x12 mm   | 109 N·m   | 1   | 97-17   |
| 18 mm  | 9x12 mm   | 125 N·m   | 1   | 97-18   |
| 19 mm  | 9x12 mm   | 145 N·m   | 1   | 97-19   |
| 21 mm  | 9x12 mm   | 160 N·m   | 1   | 97-21   |
| 22 mm  | 9x12 mm   | 160 N·m   | 1   | 97-22   |
| 24 mm  | 9x12 mm   | 160 N·m   | 1   | 97-24   |
| 27 mm  | 9x12 mm   | 160 N·m   | 1   | 97-27   |
| 30 mm  | 9x12 mm   | 160 N·m   | 1   | 97-30   |
| 32 mm  | 9x12 mm   | 160 N·m   | 1   | 97-32   |
| 13 mm  | 14x18 mm  | 51 N·m  | 1   | 147-13  |
| 14 mm  | 14x18 mm  | 63 N·m  | 1   | 147-14  |
| 15 mm  | 14x18 mm  | 77 N·m  | 1   | 147-15  |
| 16 mm  | 14x18 mm  | 92 N·m  | 1   | 147-16  |
| 17 mm  | 14x18 mm  | 109 N·m   | 1   | 147-17  |
| 18 mm  | 14x18 mm  | 125 N·m   | 1   | 147-18  |
| 19 mm  | 14x18 mm  | 145 N·m   | 1   | 147-19  |
| 21 mm  | 14x18 mm  | 190 N·m   | 1   | 147-21  |
| 22 mm  | 14x18 mm  | 220 N·m   | 1   | 147-22  |
| 24 mm  | 14x18 mm  | 280 N·m   | 1   | 147-24  |
| 25 mm  | 14x18 mm  | 320 N·m   | 1   | 147-25  |
| 27 mm  | 14x18 mm  | 360 N·m   | 1   | 147-27  |
| 30 mm  | 14x18 mm  | 360 N·m   | 1   | 147-30  |
| 32 mm  | 14x18 mm  | 360 N·m   | 1   | 147-32  |
| 33 mm  | 14x18 mm  | 360 N·m   | 1   | 147-33  |
| 34 mm  | 14x18 mm  | 360 N·m   | 1   | 147-34  |
| 35 mm  | 14x18 mm  | 360 N·m   | 1   | 147-35  |
| 36 mm  | 14x18 mm  | 360 N·m   | 1   | 147-36  |
| 37 mm  | 14x18 mm  | 360 N·m   | 1   | 147-37  |
| 38 mm  | 14x18 mm  | 360 N·m   | 1   | 147-38  |
| 39 mm  | 14x18 mm  | 360 N·m   | 1   | 147-39  |
| 41 mm  | 14x18 mm  | 360 N·m   | 1   | 147-41  |
| 45 mm  | 14x18 mm  | 360 N·m   | 1   | 147-45  |
| 46 mm  | 14x18 mm  | 360 N·m   | 1   | 147-46  |
| 50 mm  | 14x18 mm  | 360 N·m   | 1   | 147-50  |
| 55 mm  | 14x18 mm  | 360 N·m   | 1   | 147-55  |
| 60 mm  | 14x18 mm  | 360 N·m   | 1   | 147-60  |
| 65 mm  | 14x18 mm  | 360 N·m   | 1   | 147-65  |
| 68 mm  | 14x18 mm  | 360 N·m   | 1   | 147-68  |
| 70 mm  | 14x18 mm  | 360 N·m   | 1   | 147-70  |
| 75 mm  | 14x18 mm  | 360 N·m   | 1   | 147-75  |
| 90 mm  | 14x18 mm  | 360 N·m   | 1   | 147-90  |
| 24 mm  | 24x32 mm  | 1200 N·m  | 1   | 247-24  |
| 27 mm  | 24x32 mm  | 1200 N·m  | 1   | 247-27  |

|  |  |  |  |  |
|---|---|---|---|---|
| 30 mm   | 24x32 mm  | 1200 N·m  | 1   | 247-30  |
| 32 mm   | 24x32 mm  | 1200 N·m  | 1   | 247-32  |
| 34 mm   | 24x32 mm  | 1200 N·m  | 1   | 247-34  |
| 36 mm   | 24x32 mm  | 1200 N·m  | 1   | 247-36  |
| 41 mm   | 24x32 mm  | 1200 N·m  | 1   | 247-41  |
| 46 mm   | 24x32 mm  | 1200 N·m  | 1   | 247-46  |
| 50 mm   | 24x32 mm  | 1200 N·m  | 1   | 247-50  |
| 55 mm   | 24x32 mm  | 1200 N·m  | 1   | 247-55  |
| 60 mm   | 24x32 mm  | 1200 N·m  | 1   | 247-60  |
| 30 mm   | 27x36 mm  | 3000 N·m  | 1   | 277-30  |
| 32 mm   | 27x36 mm  | 3000 N·m  | 1   | 277-32  |
| 34 mm   | 27x36 mm  | 3000 N·m  | 1   | 277-34  |
| 36 mm   | 27x36 mm  | 3000 N·m  | 1   | 277-36  |
| 41 mm   | 27x36 mm  | 3000 N·m  | 1   | 277-41  |
| 46 mm   | 27x36 mm  | 3000 N·m  | 1   | 277-46  |
| 50 mm   | 27x36 mm  | 3000 N·m  | 1   | 277-50  |
| 55 mm   | 27x36 mm  | 3000 N·m  | 1   | 277-55  |
| 60 mm   | 27x36 mm  | 3000 N·m  | 1   | 277-60  |

## Open-End Imperial Wrench with Rectangular Connector



### 9/14/24/277"

|  |  |  |  |  |
|---|---|---|---|---|
| 1/4 in  | 9x12 mm   | 6 N·m   | 1   | 97-1/4  |
| 5/16 in   | 9x12 mm   | 13 N·m  | 1   | 97-5/16   |
| 3/8 in  | 9x12 mm   | 24 N·m  | 1   | 97-3/8  |
| 7/16 in   | 9x12 mm   | 32 N·m  | 1   | 97-7/16   |
| 1/2 in  | 9x12 mm   | 51 N·m  | 1   | 97-1/2  |
| 17/32 in  | 9x12 mm   | 63 N·m  | 1   | 97-17/32  |
| 9/16 in   | 9x12 mm   | 77 N·m  | 1   | 97-9/16   |
| 5/8 in  | 9x12 mm   | 92 N·m  | 1   | 97-5/8  |
| 11/16 in  | 9x12 mm   | 125 N·m   | 1   | 97-11/16  |
| 3/4 in  | 9x12 mm   | 145 N·m   | 1   | 97-3/4  |
| 13/16 in  | 9x12 mm   | 160 N·m   | 1   | 97-13/16  |
| 7/8 in  | 9x12 mm   | 160 N·m   | 1   | 97-7/8  |
| 15/16 in  | 9x12 mm   | 160 N·m   | 1   | 97-15/16  |
| 1 in  | 9x12 mm   | 160 N·m   | 1   | 97-1  |
| 7/16 in   | 14x18 mm  | 32 N·m  | 1   | 147-7/16  |
| 1/2 in  | 14x18 mm  | 51 N·m  | 1   | 147-1/2   |
| 9/16 in   | 14x18 mm  | 77 N·m  | 1   | 147-9/16  |
| 5/8 in  | 14x18 mm  | 92 N·m  | 1   | 147-5/8   |
| 11/16 in  | 14x18 mm  | 109 N·m   | 1   | 147-11/16   |
| 3/4 in  | 14x18 mm  | 145 N·m   | 1   | 147-3/4   |
| 13/16 in  | 14x18 mm  | 190 N·m   | 1   | 147-13/16   |
| 7/8 in  | 14x18 mm  | 220 N·m   | 1   | 147-7/8   |
| 15/16 in  | 14x18 mm  | 280 N·m   | 1   | 147-15/16   |
| 1 in  | 14x18 mm  | 360 N·m   | 1   | 147-1   |
| 1 1/8 in  | 14x18 mm  | 360 N·m   | 1   | 147-1.1/8   |
| 1 1/4 in  | 14x18 mm  | 360 N·m   | 1   | 147-1.1/4   |



## Ring End Metric Wrench with Rectangular Connector



### 9/14/24/278

| mm    | mm       | max      |   |        |
|-------|----------|----------|---|--------|
| 7 mm  | 9x12 mm  | 25 N·m   | 1 | 98-7   |
| 8 mm  | 9x12 mm  | 34 N·m   | 1 | 98-8   |
| 9 mm  | 9x12 mm  | 45 N·m   | 1 | 98-9   |
| 10 mm | 9x12 mm  | 58 N·m   | 1 | 98-10  |
| 11 mm | 9x12 mm  | 47 N·m   | 1 | 98-11  |
| 12 mm | 9x12 mm  | 89 N·m   | 1 | 98-12  |
| 13 mm | 9x12 mm  | 105 N·m  | 1 | 98-13  |
| 14 mm | 9x12 mm  | 125 N·m  | 1 | 98-14  |
| 15 mm | 9x12 mm  | 145 N·m  | 1 | 98-15  |
| 16 mm | 9x12 mm  | 160 N·m  | 1 | 98-16  |
| 17 mm | 9x12 mm  | 160 N·m  | 1 | 98-17  |
| 18 mm | 9x12 mm  | 160 N·m  | 1 | 98-18  |
| 19 mm | 9x12 mm  | 160 N·m  | 1 | 98-19  |
| 21 mm | 9x12 mm  | 160 N·m  | 1 | 98-21  |
| 22 mm | 9x12 mm  | 160 N·m  | 1 | 98-22  |
| 13 mm | 14x18 mm | 105 N·m  | 1 | 148-13 |
| 14 mm | 14x18 mm | 125 N·m  | 1 | 148-14 |
| 15 mm | 14x18 mm | 150 N·m  | 1 | 148-15 |
| 16 mm | 14x18 mm | 175 N·m  | 1 | 148-16 |
| 17 mm | 14x18 mm | 200 N·m  | 1 | 148-17 |
| 18 mm | 14x18 mm | 230 N·m  | 1 | 148-18 |
| 19 mm | 14x18 mm | 260 N·m  | 1 | 148-19 |
| 21 mm | 14x18 mm | 330 N·m  | 1 | 148-21 |
| 22 mm | 14x18 mm | 360 N·m  | 1 | 148-22 |
| 24 mm | 14x18 mm | 360 N·m  | 1 | 148-24 |
| 27 mm | 14x18 mm | 360 N·m  | 1 | 148-27 |
| 28 mm | 14x18 mm | 360 N·m  | 1 | 148-28 |
| 30 mm | 14x18 mm | 360 N·m  | 1 | 148-30 |
| 32 mm | 14x18 mm | 360 N·m  | 1 | 148-32 |
| 34 mm | 14x18 mm | 360 N·m  | 1 | 148-34 |
| 36 mm | 14x18 mm | 360 N·m  | 1 | 148-36 |
| 41 mm | 14x18 mm | 360 N·m  | 1 | 148-41 |
| 24 mm | 24x32 mm | 1200 N·m | 1 | 248-24 |
| 27 mm | 24x32 mm | 1200 N·m | 1 | 248-27 |
| 30 mm | 24x32 mm | 1200 N·m | 1 | 248-30 |
| 32 mm | 24x32 mm | 1200 N·m | 1 | 248-32 |
| 34 mm | 24x32 mm | 1200 N·m | 1 | 248-34 |
| 36 mm | 24x32 mm | 1200 N·m | 1 | 248-36 |
| 41 mm | 24x32 mm | 1200 N·m | 1 | 248-41 |
| 46 mm | 24x32 mm | 1200 N·m | 1 | 248-46 |
| 50 mm | 24x32 mm | 1200 N·m | 1 | 248-50 |
| 55 mm | 24x32 mm | 1200 N·m | 1 | 248-55 |
| 60 mm | 24x32 mm | 1200 N·m | 1 | 248-60 |
| 30 mm | 27x36 mm | 3000 N·m | 1 | 278-30 |
| 32 mm | 27x36 mm | 1240 N·m | 1 | 278-32 |
| 34 mm | 27x36 mm | 3000 N·m | 1 | 278-34 |
| 36 mm | 27x36 mm | 3000 N·m | 1 | 278-36 |
| 41 mm | 27x36 mm | 3000 N·m | 1 | 278-41 |

| mm    | mm       | max      |   |        |
|-------|----------|----------|---|--------|
| 46 mm | 27x36 mm | 3000 N·m | 1 | 278-46 |
| 50 mm | 27x36 mm | 3000 N·m | 1 | 278-50 |
| 55 mm | 27x36 mm | 3000 N·m | 1 | 278-55 |
| 60 mm | 27x36 mm | 3000 N·m | 1 | 278-60 |

## Ring End Imperial Wrench with Rectangular Connector



### 9/14/24/278"





| in       | mm       | max     |   |           |
|----------|----------|---------|---|-----------|
| 1/4 in   | 9x12 mm  | 25 N·m  | 1 | 98-1/4    |
| 5/16 in  | 9x12 mm  | 34 N·m  | 1 | 98-5/16   |
| 3/8 in   | 9x12 mm  | 58 N·m  | 1 | 98-3/8    |
| 7/16 in  | 9x12 mm  | 72 N·m  | 1 | 98-7/16   |
| 1/2 in   | 9x12 mm  | 105 N·m | 1 | 98-1/2    |
| 9/16 in  | 9x12 mm  | 125 N·m | 1 | 98-9/16   |
| 5/8 in   | 9x12 mm  | 160 N·m | 1 | 98-5/8    |
| 11/16 in | 9x12 mm  | 160 N·m | 1 | 98-11/16  |
| 3/4 in   | 9x12 mm  | 57 N·m  | 1 | 98-3/4    |
| 13/16 in | 14x18 mm | 330 N·m | 1 | 148-13/16 |
| 13/16 in | 9x12 mm  | 160 N·m | 1 | 98-13/16  |
| 7/8 in   | 9x12 mm  | 160 N·m | 1 | 98-7/8    |
| 1/2 in   | 14x18 mm | 105 N·m | 1 | 148-1/2   |
| 9/16 in  | 14x18 mm | 150 N·m | 1 | 148-9/16  |
| 5/8 in   | 14x18 mm | 175 N·m | 1 | 148-5/8   |
| 11/16 in | 14x18 mm | 230 N·m | 1 | 148-11/16 |
| 3/4 in   | 14x18 mm | 260 N·m | 1 | 148-3/4   |
| 15/16 in | 14x18 mm | 360 N·m | 1 | 148-15/16 |
| 7/8 in   | 14x18 mm | 360 N·m | 1 | 148-7/8   |
| 1 in     | 14x18 mm | 360 N·m | 1 | 148-1     |

## Flare Nut End Wrench with Rectangular Connector



### 99 in





| in      | mm      | max    |   |         |
|---------|---------|--------|---|---------|
| 3/8 in  | 9x12 mm | 9 N·m  | 1 | 99-3/8  |
| 7/16 in | 9x12 mm | 16 N·m | 1 | 99-7/16 |
| 1/2 in  | 9x12 mm | 28 N·m | 1 | 99-1/2  |

|  |  |  |  |  |
|--|---|---|---|---|
|  | mm  |   |   |   |
| 9/16 in  | 9x12 mm   | 31 N·m  | 1   | 99-9/16   |
| 5/8 in   | 9x12 mm   | 46 N·m  | 1   | 99-5/8  |
| 11/16 in   | 9x12 mm   | 65 N·m  | 1   | 99-11/16  |
| 3/4 in   | 9x12 mm   | 74 N·m  | 1   | 99-3/4  |

### Flare Nut End Wrench with Rectangular Connector







**99**

|  |  |  |  |  |
|--|---|---|---|---|
|  | mm  |   |   |   |
| 10 mm  | 9x12 mm   | 14 N·m  | 1   | 99-10   |
| 11 mm  | 9x12 mm   | 19 N·m  | 1   | 99-11   |
| 12 mm  | 9x12 mm   | 24 N·m  | 1   | 99-12   |
| 13 mm  | 9x12 mm   | 30 N·m  | 1   | 99-13   |
| 14 mm  | 9x12 mm   | 37 N·m  | 1   | 99-14   |
| 16 mm  | 9x12 mm   | 46 N·m  | 1   | 99-16   |
| 17 mm  | 9x12 mm   | 55 N·m  | 1   | 99-17   |
| 18 mm  | 9x12 mm   | 65 N·m  | 1   | 99-18   |
| 19 mm  | 9x12 mm   | 74 N·m  | 1   | 99-19   |
| 21 mm  | 9x12 mm   | 87 N·m  | 1   | 99-21   |
| 22 mm  | 9x12 mm   | 96 N·m  | 1   | 99-22   |
| 24 mm  | 9x12 mm   | 96 N·m  | 1   | 99-24   |

### Increasing and Reducing Rectangular Connector Adaptors







**9/14/24/27A**

|  |  |  |  |  |
|--|---|---|---|---|
| mm   | mm  |   |   |   |
| 9x12 mm  | 14x18 mm  | 160 N·m   | 1   | 9A-14   |
| 14x18 mm   | 9x12 mm   | 160 N·m   | 1   | 14A-9   |
| 14x18 mm   | 24x32 mm  | 360 N·m   | 1   | 14A-32  |
| 24x32 mm   | 14x18 mm  | 360 N·m   | 1   | 24A-14  |
| 24x32 mm   | 27x36 mm  | 1200 N·m  | 1   | 24A-27  |
| 27x36 mm   | 24x32 mm  | 1200 N·m  | 1   | 27A-24  |

### Weld-On Adaptor with Rectangular Connector







**9/14/24W**

|  |  |  |  |
|---|---|---|---|
| mm  | L   |   |   |
| 9x12 mm   | 23.8 mm   | 1   | 9W  |
| 14x18 mm  | 38 mm   | 1   | 14W   |
| 24x32 mm  | 65 mm   | 1   | 24W   |

### Round Ratchet Head with Spigot Connector







**16R/22R**

|  |  |  |  |  |
|---|--|---|---|---|
|   | mm   |   |   |   |
| 1/4" in   | 16 mm  | 20 N·m  | 1   | 16R-1/4   |
| 3/8" in   | 16 mm  | 160 N·m   | 1   | 16R-3/8   |
| 1/2" in   | 16 mm  | 420 N·m   | 1   | 16R-1/2   |
| 3/4" in   | 22 mm  | 1200 N·m  | 1   | 22R-3/4   |

### Fixed Square Head with Spigot Connector



**16F/22F**





|  |  |  |  |  |
|---|--|---|---|---|
|   | mm   |   |   |   |
| 1/4" in   | 16 mm  | 20 N·m  | 1   | 16F-1/4   |
| 3/8" in   | 16 mm  | 160 N·m   | 1   | 16F-3/8   |
| 1/2" in   | 16 mm  | 420 N·m   | 1   | 16F-1/2   |
| 3/4" in   | 22 mm  | 1200 N·m  | 1   | 22F-3/4   |



## Open End Metric Wrench with Spigot Connector







### 167/227

|  |  |  |  |  |
|--|---|---|---|---|
| mm   | mm  |   |   |   |
| 7 mm   | 16 mm   | 9 N·m   | 1   | 167-7   |
| 8 mm   | 16 mm   | 13 N·m  | 1   | 167-8   |
| 9 mm   | 16 mm   | 18 N·m  | 1   | 167-9   |
| 10 mm  | 16 mm   | 24 N·m  | 1   | 167-10  |
| 11 mm  | 16 mm   | 32 N·m  | 1   | 167-11  |
| 12 mm  | 16 mm   | 41 N·m  | 1   | 167-12  |
| 13 mm  | 16 mm   | 51 N·m  | 1   | 167-13  |
| 14 mm  | 16 mm   | 63 N·m  | 1   | 167-14  |
| 15 mm  | 16 mm   | 77 N·m  | 1   | 167-15  |
| 16 mm  | 16 mm   | 92 N·m  | 1   | 167-16  |
| 17 mm  | 16 mm   | 109 N·m   | 1   | 167-17  |
| 18 mm  | 16 mm   | 125 N·m   | 1   | 167-18  |
| 19 mm  | 16 mm   | 145 N·m   | 1   | 167-19  |
| 20 mm  | 16 mm   | 160 N·m   | 1   | 167-20  |
| 21 mm  | 16 mm   | 190 N·m   | 1   | 167-21  |
| 22 mm  | 16 mm   | 220 N·m   | 1   | 167-22  |
| 23 mm  | 16 mm   | 250 N·m   | 1   | 167-23  |
| 24 mm  | 16 mm   | 280 N·m   | 1   | 167-24  |
| 25 mm  | 16 mm   | 320 N·m   | 1   | 167-25  |
| 26 mm  | 16 mm   | 360 N·m   | 1   | 167-26  |
| 27 mm  | 16 mm   | 360 N·m   | 1   | 167-27  |
| 28 mm  | 16 mm   | 360 N·m   | 1   | 167-28  |
| 30 mm  | 16 mm   | 360 N·m   | 1   | 167-30  |
| 32 mm  | 16 mm   | 360 N·m   | 1   | 167-32  |
| 36 mm  | 16 mm   | 360 N·m   | 1   | 167-36  |
| 22 mm  | 22 mm   | 1200 N·m  | 1   | 227-22  |
| 24 mm  | 22 mm   | 1200 N·m  | 1   | 227-24  |
| 27 mm  | 22 mm   | 1200 N·m  | 1   | 227-27  |
| 30 mm  | 22 mm   | 1200 N·m  | 1   | 227-30  |
| 32 mm  | 22 mm   | 1200 N·m  | 1   | 227-32  |
| 34 mm  | 22 mm   | 1200 N·m  | 1   | 227-34  |
| 36 mm  | 22 mm   | 1200 N·m  | 1   | 227-36  |
| 41 mm  | 22 mm   | 1200 N·m  | 1   | 227-41  |
| 46 mm  | 22 mm   | 1200 N·m  | 1   | 227-46  |

## Open-End Imperial Wrench with Spigot Connector







### 167

|  |  |  |  |  |
|---|---|---|---|---|
|   | mm  |   |   |   |
| 5/16 in   | 16 mm   | 34 N·m  | 1   | 167-5/16  |
| 3/8 in  | 16 mm   | 45 N·m  | 1   | 167-3/8   |
| 7/16 in   | 16 mm   | 72 N·m  | 1   | 167-7/16  |
| 1/2 in  | 16 mm   | 51 N·m  | 1   | 167-1/2   |
| 9/16 in   | 16 mm   | 77 N·m  | 1   | 167-9/16  |
| 5/8 in  | 16 mm   | 92 N·m  | 1   | 167-5/8   |
| 11/16 in  | 16 mm   | 109 N·m   | 1   | 167-11/16   |
| 3/4 in  | 16 mm   | 145 N·m   | 1   | 167-3/4   |
| 13/16 in  | 16 mm   | 190 N·m   | 1   | 167-13/16   |
| 7/8 in  | 16 mm   | 220 N·m   | 1   | 167-7/8   |
| 15/16 in  | 16 mm   | 280 N·m   | 1   | 167-15/16   |
| 1 in  | 16 mm   | 360 N·m   | 1   | 167-1   |
| 1.1/16 in   | 16 mm   | 360 N·m   | 1   | 167-1.1/16  |
| 1.1/8 in  | 16 mm   | 360 N·m   | 1   | 167-1.1/8   |
| 1.3/16 in   | 16 mm   | 360 N·m   | 1   | 167-1.3/16  |
| 1.1/4 in  | 16 mm   | 360 N·m   | 1   | 167-1.1/4   |





## Ring End Metric Wrench with Spigot Connector



### 168/228

|  |  |  |  |  |
|---|---|---|---|---|
|   | mm  |   |   |   |
| 7 mm  | 16 mm   | 25 N·m  | 1   | 168-7   |
| 8 mm  | 16 mm   | 34 N·m  | 1   | 168-8   |
| 9 mm  | 16 mm   | 45 N·m  | 1   | 168-9   |
| 10 mm   | 16 mm   | 58 N·m  | 1   | 168-10  |
| 11 mm   | 16 mm   | 72 N·m  | 1   | 168-11  |
| 12 mm   | 16 mm   | 89 N·m  | 1   | 168-12  |







|  mm |  mm |  N·m |   |
|---|--|---|---|
| 13 mm   | 16 mm  | 105 N·m   | 1 168-13  |
| 14 mm   | 16 mm  | 125 N·m   | 1 168-14  |
| 15 mm   | 16 mm  | 150 N·m   | 1 168-15  |
| 16 mm   | 16 mm  | 175 N·m   | 1 168-16  |
| 17 mm   | 16 mm  | 200 N·m   | 1 168-17  |
| 18 mm   | 16 mm  | 230 N·m   | 1 168-18  |
| 19 mm   | 16 mm  | 260 N·m   | 1 168-19  |
| 20 mm   | 16 mm  | 290 N·m   | 1 168-20  |
| 21 mm   | 16 mm  | 330 N·m   | 1 168-21  |
| 22 mm   | 16 mm  | 360 N·m   | 1 168-22  |
| 23 mm   | 16 mm  | 360 N·m   | 1 168-23  |
| 24 mm   | 16 mm  | 360 N·m   | 1 168-24  |
| 26 mm   | 16 mm  | 360 N·m   | 1 168-26  |
| 27 mm   | 16 mm  | 360 N·m   | 1 168-27  |
| 22 mm   | 22 mm  | 1200 N·m  | 1 228-22  |
| 24 mm   | 22 mm  | 1200 N·m  | 1 228-24  |
| 27 mm   | 22 mm  | 1200 N·m  | 1 228-27  |
| 30 mm   | 22 mm  | 1200 N·m  | 1 228-30  |
| 32 mm   | 22 mm  | 1200 N·m  | 1 228-32  |
| 34 mm   | 22 mm  | 1200 N·m  | 1 228-34  |
| 36 mm   | 22 mm  | 1200 N·m  | 1 228-36  |
| 41 mm   | 22 mm  | 1200 N·m  | 1 228-41  |
| 46 mm   | 22 mm  | 1200 N·m  | 1 228-46  |

### Ring End Imperial Wrench with Spigot Connector







### 168

|  in |  mm |  N·m |   |
|---|--|---|---|
| 5/16 in   | 16 mm  | 34 N·m  | 1 168-5/16  |
| 3/8 in  | 16 mm  | 58 N·m  | 1 168-3/8   |
| 7/16 in   | 16 mm  | 89 N·m  | 1 168-7/16  |
| 1/2 in  | 16 mm  | 105 N·m   | 1 168-1/2   |
| 9/16 in   | 16 mm  | 125 N·m   | 1 168-9/16  |
| 5/8 in  | 16 mm  | 125 N·m   | 1 168-5/8   |
| 11/16 in  | 16 mm  | 125 N·m   | 1 168-11/16   |
| 3/4 in  | 16 mm  | 260 N·m   | 1 168-3/4   |
| 13/16 in  | 16 mm  | 290 N·m   | 1 168-13/16   |
| 7/8 in  | 16 mm  | 360 N·m   | 1 168-7/8   |
| 15/16 in  | 16 mm  | 360 N·m   | 1 168-15/16   |
| 1 in  | 16 mm  | 360 N·m   | 1 168-1   |
| 1.1/16 in   | 16 mm  | 360 N·m   | 1 168-1.1/16  |
| 1.3/16 in   | 16 mm  | 360 N·m   | 1 168-1.3/16  |

### Flare Nut End Metric Wrench with Spigot Connector



### 169

|  mm |  mm |  N·m |   |
|--|--|---|---|
| 7 mm   | 16 mm  | 6 N·m   | 1 169-7   |
| 8 mm   | 16 mm  | 8 N·m   | 1 169-8   |
| 9 mm   | 16 mm  | 10 N·m  | 1 169-9   |
| 10 mm  | 16 mm  | 12 N·m  | 1 169-10  |
| 11 mm  | 16 mm  | 16 N·m  | 1 169-11  |
| 12 mm  | 16 mm  | 16 N·m  | 1 169-12  |
| 13 mm  | 16 mm  | 28 N·m  | 1 169-13  |
| 14 mm  | 16 mm  | 31 N·m  | 1 169-14  |
| 15 mm  | 16 mm  | 38 N·m  | 1 169-15  |
| 16 mm  | 16 mm  | 46 N·m  | 1 169-16  |
| 17 mm  | 16 mm  | 53 N·m  | 1 169-17  |
| 18 mm  | 16 mm  | 65 N·m  | 1 169-18  |
| 19 mm  | 16 mm  | 74 N·m  | 1 169-19  |
| 20 mm  | 16 mm  | 86 N·m  | 1 169-20  |
| 21 mm  | 16 mm  | 100 N·m   | 1 169-21  |
| 22 mm  | 16 mm  | 115 N·m   | 1 169-22  |
| 23 mm  | 16 mm  | 125 N·m   | 1 169-23  |
| 24 mm  | 16 mm  | 145 N·m   | 1 169-24  |
| 27 mm  | 16 mm  | 160 N·m   | 1 169-27  |

## EMPTY SET CASES FOR TORQUE TOOLS

### Double Wall Shock Absorbing Empty Cases for Torque Tools



### 4750BMCT

|  kg |   |
|--|---|
| 0.95 kg  | 1 4750BMCT1   |





**BAHCO**



# Power Tool Accessories



# HOLESAWS

Sandflex® Bi-Metal Holesaws for Metal/  
Wood Boards 14 mm-210 mm



## 3830

| Icon | Icon |        |              |
|------|------|--------|--------------|
|      |      | 14 mm  | 1 3830-14-C  |
|      |      | 16 mm  | 1 3830-16-C  |
|      |      | 17 mm  | 1 3830-17-C  |
|      |      | 19 mm  | 1 3830-19-C  |
|      |      | 20 mm  | 1 3830-20-C  |
|      |      | 21 mm  | 1 3830-21-C  |
|      |      | 22 mm  | 1 3830-22-C  |
|      |      | 24 mm  | 1 3830-24-C  |
|      |      | 25 mm  | 1 3830-25-C  |
|      |      | 27 mm  | 1 3830-27-C  |
|      |      | 29 mm  | 1 3830-29-C  |
|      |      | 30 mm  | 1 3830-30-C  |
|      |      | 32 mm  | 1 3830-32-C  |
|      |      | 33 mm  | 1 3830-33-C  |
|      |      | 35 mm  | 1 3830-35-C  |
|      |      | 37 mm  | 1 3830-37-C  |
|      |      | 38 mm  | 1 3830-38-C  |
|      |      | 40 mm  | 1 3830-40-C  |
|      |      | 41 mm  | 1 3830-41-C  |
|      |      | 43 mm  | 1 3830-43-C  |
|      |      | 44 mm  | 1 3830-44-C  |
|      |      | 46 mm  | 1 3830-46-C  |
|      |      | 48 mm  | 1 3830-48-C  |
|      |      | 50 mm  | 1 3830-50-C  |
|      |      | 51 mm  | 1 3830-51-C  |
|      |      | 52 mm  | 1 3830-52-C  |
|      |      | 54 mm  | 1 3830-54-C  |
|      |      | 55 mm  | 1 3830-55-C  |
|      |      | 56 mm  | 1 3830-56-C  |
|      |      | 57 mm  | 1 3830-57-C  |
|      |      | 59 mm  | 1 3830-59-C  |
|      |      | 60 mm  | 1 3830-60-C  |
|      |      | 64 mm  | 1 3830-64-C  |
|      |      | 65 mm  | 1 3830-65-C  |
|      |      | 67 mm  | 1 3830-67-C  |
|      |      | 68 mm  | 1 3830-68-C  |
|      |      | 70 mm  | 1 3830-70-C  |
|      |      | 73 mm  | 1 3830-73-C  |
|      |      | 76 mm  | 1 3830-76-C  |
|      |      | 79 mm  | 1 3830-79-C  |
|      |      | 83 mm  | 1 3830-83-C  |
|      |      | 86 mm  | 1 3830-86-C  |
|      |      | 89 mm  | 1 3830-89-C  |
|      |      | 92 mm  | 1 3830-92-C  |
|      |      | 95 mm  | 1 3830-95-C  |
|      |      | 98 mm  | 1 3830-98-C  |
|      |      | 102 mm | 1 3830-102-C |
|      |      | 105 mm | 1 3830-105-C |
|      |      | 108 mm | 1 3830-108-C |

| Icon | Icon |        |                 |
|------|------|--------|-----------------|
|      |      | 111 mm | 1 3830-111-C    |
|      |      | 114 mm | 1 3830-114-C    |
|      |      | 121 mm | 1 3830-121-C    |
|      |      | 127 mm | 1 3830-127-C    |
|      |      | 133 mm | 1 3830-133-C    |
|      |      | 140 mm | 1 3830-140-C    |
|      |      | 146 mm | 1 3830-146-C    |
|      |      | 152 mm | 1 3830-152-C    |
|      |      | 14 mm  | 6 3830-14-VIP   |
|      |      | 16 mm  | 6 3830-16-VIP   |
|      |      | 17 mm  | 6 3830-17-VIP   |
|      |      | 19 mm  | 6 3830-19-VIP   |
|      |      | 20 mm  | 6 3830-20-VIP   |
|      |      | 21 mm  | 6 3830-21-VIP   |
|      |      | 22 mm  | 6 3830-22-VIP   |
|      |      | 24 mm  | 6 3830-24-VIP   |
|      |      | 25 mm  | 6 3830-25-VIP   |
|      |      | 27 mm  | 6 3830-27-VIP   |
|      |      | 29 mm  | 6 3830-29-VIP   |
|      |      | 30 mm  | 6 3830-30-VIP   |
|      |      | 32 mm  | 6 3830-32-VIP   |
|      |      | 33 mm  | 6 3830-33-VIP   |
|      |      | 35 mm  | 6 3830-35-VIP   |
|      |      | 37 mm  | 6 3830-37-VIP   |
|      |      | 38 mm  | 6 3830-38-VIP   |
|      |      | 40 mm  | 6 3830-40-VIP   |
|      |      | 41 mm  | 6 3830-41-VIP   |
|      |      | 43 mm  | 6 3830-43-VIP   |
|      |      | 44 mm  | 6 3830-44-VIP   |
|      |      | 46 mm  | 6 3830-46-VIP   |
|      |      | 48 mm  | 6 3830-48-VIP   |
|      |      | 50 mm  | 6 3830-50-VIP   |
|      |      | 51 mm  | 6 3830-51-VIP   |
|      |      | 52 mm  | 4 3830-52-VIP   |
|      |      | 54 mm  | 4 3830-54-VIP   |
|      |      | 55 mm  | 4 3830-55-VIP   |
|      |      | 56 mm  | 4 3830-56-VIP   |
|      |      | 57 mm  | 4 3830-57-VIP   |
|      |      | 59 mm  | 4 3830-59-VIP   |
|      |      | 60 mm  | 4 3830-60-VIP   |
|      |      | 62 mm  | 4 3830-62-VIP   |
|      |      | 64 mm  | 4 3830-64-VIP   |
|      |      | 65 mm  | 4 3830-65-VIP   |
|      |      | 67 mm  | 4 3830-67-VIP   |
|      |      | 68 mm  | 4 3830-68-VIP   |
|      |      | 70 mm  | 4 3830-70-VIP   |
|      |      | 73 mm  | 4 3830-73-VIP   |
|      |      | 76 mm  | 4 3830-76-VIP   |
|      |      | 79 mm  | 4 3830-79-VIP   |
|      |      | 83 mm  | 4 3830-83-VIP   |
|      |      | 86 mm  | 4 3830-86-VIP   |
|      |      | 89 mm  | 4 3830-89-VIP   |
|      |      | 92 mm  | 4 3830-92-VIP   |
|      |      | 95 mm  | 4 3830-95-VIP   |
|      |      | 98 mm  | 4 3830-98-VIP   |
|      |      | 102 mm | 4 3830-102-VIP  |
|      |      | 105 mm | 4 3830-105-VIP  |
|      |      | 108 mm | 4 3830-108-VIP  |
|      |      | 111 mm | 4 3830-111-VIP  |
|      |      | 114 mm | 4 3830-114-VIP  |
|      |      | 121 mm | 1 3830-121-VIP  |
|      |      | 127 mm | 1 3830-127-VIP  |
|      |      | 133 mm | 1 3830-133-VIP  |
|      |      | 140 mm | 1 3830-140-VIP  |
|      |      | 146 mm | 1 3830-146-VIP  |
|      |      | 152 mm | 1 3830-152-VIP  |
|      |      | 168 mm | 1 3830-168      |
|      |      | 177 mm | 1 3830-177-HIGH |
|      |      | 210 mm | 1 3830-210      |

## Sandflex® Bi-Metal Holesaws, 4 pack



## 3830-4P

| Icon | Icon | Icon | Icon |   |       |
|------|------|------|------|---|-------|
|      |      |      |      | 4 | 19 mm |
|      |      |      |      | 4 | 20 mm |
|      |      |      |      | 4 | 22 mm |
|      |      |      |      | 4 | 25 mm |
|      |      |      |      | 4 | 27 mm |
|      |      |      |      | 4 | 29 mm |
|      |      |      |      | 4 | 30 mm |
|      |      |      |      | 4 | 32 mm |
|      |      |      |      | 4 | 35 mm |

## Sandflex® Bi-Metal Holesaw Set 20x4 mm + 25x4 mm - 11 pcs



## 3834-CP-20/25

| Icon | Icon |       |                 |
|------|------|-------|-----------------|
|      |      | 600 g | 1 3834-CP-20/25 |

3830-20-Cx 4, 3830-25-Cx 4

3834-ARBR-930

3834-DRLx 2



Sandflex® Bi-Metal Holesaw Set 20–76 mm - 10 pcs



**3834-PROMO-82**

**g** 1 3834-PROMO-82

- 3830-20-C, 3830-25-C, 3830-30-C, 3830-35-C, 3830-44-C, 3830-51-C, 3830-64-C, 3830-76-C
- 3834-ARBR-930
- 3834-ARBR-11152QC

Sandflex® Bi-Metal Holesaw Set 16–44 mm - 14 pcs



**3834-PROMO-122**

**g** 1 3834-PROMO-122

- 3830-16-C, 3830-20-Cx 2, 3830-22-C, 3830-25-Cx 2, 3830-29-C, 3830-32-C, 3830-35-Cx 2, 3830-38-C, 3830-44-C
- 3834-ARBR-930
- 3834-ARBR-11152QC

Sandflex® Bi-Metal Holesaw Set 19–76 mm - 14 pcs



**3834-PROMO-122-76**

**g** 1 3834-PROMO-122-76

- 3830-19-C, 3830-20-C, 3830-22-C, 3830-25-C, 3830-27-C, 3830-32-C, 3830-35-C, 3830-38-C, 3830-40-C, 3830-51-C, 3830-64-C, 3830-76-C
- 3834-ARBR-930
- 3834-ARBR-9100

Sandflex® Bi-Metal Holesaw Set 35–83 mm - 9 pcs



**3834-SET-72-35/83**

**g** 1 3834-SET-72-35/83

- 3830-35-C, 3830-40-C, 3830-44-C, 3830-51-C, 3830-57-C, 3830-68-C, 3830-83-C
- 3834-ARBR-9100
- 3834-DRL

Sandflex® Bi-Metal Holesaw Set 51 mm-111 mm - 6 Pcs



**3834-42**

**g** 2025 g 1 3834-SET-42

- 3830-51-VIP, 3830-76-VIP, 3830-86-VIP, 3830-111-VIP
- 3834-ARBR-9100
- 3834-ES

Sandflex® Bi-Metal Holesaw Set 19 mm-79 mm - 13 Pcs



**3834-53**

**g** 2370 g 1 3834-SET-53

- 3830-19-VIP, 3830-22-VIP, 3830-25-VIP, 3830-29-VIP, 3830-30-VIP, 3830-35-VIP, 3830-37-VIP, 3830-41-VIP, 3830-52-VIP, 3830-60-VIP, 3830-79-VIP
- 3834-ARBR-930
- 3834-ARBR-9100





Sandflex® Bi-Metal Holesaw Set 51 mm-114 mm - 7 Pcs



**3834-61**

|        |   |             |
|--------|---|-------------|
|        |   |             |
| 3145 g | 1 | 3834-SET-61 |

|   |  |
|---|--|
| 3830-44-VIP, 3830-51-VIP, 3830-57-VIP, 3830-73-VIP, 3830-86-VIP, 3830-114-VIP |  |
| 3834-ARBR-9100  |  |

Sandflex® Bi-Metal Holesaw Set for Metal/Wood Boards 16 mm-50 mm - 8 Pcs



**3834-62-16/50**

|        |   |                   |
|--------|---|-------------------|
|        |   |                   |
| 1065 g | 1 | 3834-SET-62-16/50 |

|  |  |
|--|--|
| 3830-16-VIP, 3830-20-VIP, 3830-25-VIP, 3830-32-VIP, 3830-40-VIP, 3830-50-VIP |  |
| 3834-ARBR-9100   |  |
| 3834-ARBR-930  |  |

Sandflex® Bi-Metal Holesaw Set for Metal/Wood Boards 22 mm-64 mm - 9 Pcs



**3834-65-22/64**

|        |   |                   |
|--------|---|-------------------|
|        |   |                   |
| 1625 g | 1 | 3834-SET-65-22/64 |

|  |  |
|--|--|
| 3830-22-VIP, 3830-29-VIP, 3830-35-VIP, 3830-44-VIP, 3830-51-VIP, 3830-64-VIP |  |
| 3834-ARBR-1130   |  |
| 3834-ARBR-11152  |  |
| 3834-DRL   |  |

Sandflex® Bi-Metal Holesaw Set 19 mm-48 mm - 8 Pcs



**3834-62**

|        |   |             |
|--------|---|-------------|
|        |   |             |
| 1050 g | 1 | 3834-SET-62 |

|  |  |
|--|--|
| 3830-19-VIP, 3830-21-VIP, 3830-22-VIP, 3830-29-VIP, 3830-38-VIP, 3830-48-VIP |  |
| 3834-ARBR-930  |  |
| 3834-ARBR-9100   |  |

Sandflex® Bi-Metal Holesaw Set for Metal/Wood Boards 16 mm-51 mm - 9 Pcs



**3834-65-16/51**

|        |   |                   |
|--------|---|-------------------|
|        |   |                   |
| 1465 g | 1 | 3834-SET-65-16/51 |

|  |  |
|--|--|
| 3830-16-VIP, 3830-20-VIP, 3830-25-VIP, 3830-32-VIP, 3830-40-VIP, 3830-51-VIP |  |
| 3834-ARBR-1130   |  |
| 3834-ARBR-11152  |  |
| 3834-DRL   |  |

Sandflex® Bi-Metal Holesaw Set 19 mm-64 mm - 9 Pcs



**3834-72**

|        |   |             |
|--------|---|-------------|
|        |   |             |
| 1080 g | 1 | 3834-SET-72 |

|   |  |
|---|--|
| 3830-19-VIP, 3830-22-VIP, 3830-29-VIP, 3830-35-VIP, 3830-44-VIP, 3830-51-VIP, 3830-64-VIP |  |
| 3834-ARBR-930   |  |
| 3834-ARBR-9100  |  |

Sandflex® Bi-Metal Holesaw Set 16 mm-92 mm - 9 Pcs



**3834-73**

**g** 2080 g 1 3834-SET-73

- 3830-16-VIP, 3830-22-VIP, 3830-51-VIP, 3830-57-VIP, 3830-73-VIP, 3830-76-VIP, 3830-92-VIP
- 3834-ARBR-930
- 3834-ARBR-9100

Sandflex® Bi-Metal Holesaw Set 22 mm-68 mm - 10 Pcs



**3834-73-22/68**

**g** 2170 g 1 3834-SET-73-22/68

- 3830-22-VIP, 3830-29-VIP, 3830-35-VIP, 3830-44-VIP, 3830-51-VIP, 3830-64-VIP, 3830-68-VIP
- 3834-ARBR-1130
- 3834-ARBR-11152
- 3834-DRL

Sandflex® Bi-Metal Holesaw Set 16 mm-86 mm - 13 Pcs



**3834-SET-77**

**g** 3325 g 1 3834-SET-77

- 3830-16-VIP, 3830-20-VIP, 3830-25-VIP, 3830-32-VIP, 3830-41-VIP, 3830-51-VIP, 3830-73-VIP, 3830-76-VIP, 3830-83-VIP, 3830-86-VIP
- 3834-ARBR-930
- 3834-ARBR-9100
- 3834-DRL

Sandflex® Bi-Metal Holesaw Set 25-114 mm - 12 pcs



**3834-SET-84-ES**

**g** 3600 g 1 3834-SET-84-ES

- 3830-25-C, 3830-30-C, 3830-35-C, 3830-51-C, 3830-54-C, 3830-76-C, 3830-92-C, 3830-114-C
- 3834-ARBR-930ESM, 3834-ARBR-9100ESM
- 3834-DRL-HSS-ES
- 3834-UPSIZE

Sandflex® Bi-Metal Holesaw Set 25 mm-114 mm - 12 Pcs



**3834-86**

**g** 2540 g 1 3834-SET-86

- 3830-25-VIP, 3830-32-VIP, 3830-35-VIP, 3830-51-VIP, 3830-54-VIP, 3830-76-VIP, 3830-92-VIP, 3830-114-VIP
- 3834-ARBR-1130
- 3834-ARBR-11152
- 3834-DRLx 2
- 3834-ADP

Sandflex® Bi-Metal Holesaw Set 19 mm-65 mm - 12 Pcs



**3834-87**

**g** 1925 g 1 3834-SET-87

- 3830-19-VIP, 3830-22-VIP, 3830-29-VIP, 3830-38-VIP, 3830-43-VIP, 3830-48-VIP, 3830-52-VIP, 3830-65-VIP
- 3834-ARBR-930
- 3834-ARBR-9100
- 3834-DRL
- 3834-ES



Sandflex® Bi-Metal Holesaw Set for Metal/  
Wood Boards 16 mm-83 mm - 11 Pcs



**3834-92**



1440 g



1 3834-SET-92

3830-16-VIP, 3830-22-VIP, 3830-25-VIP, 3830-29-VIP, 3830-32-VIP, 3830-41-VIP, 3830-51-VIP, 3830-73-VIP, 3830-83-VIP



3834-ARBR-930



3834-ARBR-9100



Sandflex® Bi-Metal Holesaw Set for Metal/  
Wood Boards 16 mm-67 mm - 11 Pcs



**3834-94**



1815 g



1 3834-SET-94

3830-16-VIP, 3830-19-VIP, 3830-22-VIP, 3830-25-VIP, 3830-30-VIP, 3830-35-VIP, 3830-41-VIP, 3830-51-VIP, 3830-67-VIP



3834-ARBR-1130



3834-ARBR-11152



Sandflex® Bi-Metal Holesaw Set 16 mm-67  
mm - 11 Pcs



**3834-103**



2015 g



1 3834-SET-103

3830-16-VIP, 3830-19-VIP, 3830-24-VIP, 3830-29-VIP, 3830-38-VIP, 3830-44-VIP, 3830-57-VIP, 3830-67-VIP



3834-ARBR-1130



3834-ARBR-11152



3834-DRL



Sandflex® Bi-Metal Holesaw Set 16-83  
mm - 12 pcs



**3834-93**



2360 g



1 3834-SET-93

3830-16-VIP, 3830-20-VIP, 3830-25-VIP, 3830-32-VIP, 3830-40-VIP, 3830-51-VIP, 3830-67-VIP, 3830-76-VIP, 3830-83-VIP



3834-ARBR-930



3834-ARBR-9100QC



3834-DRL



Sandflex® Bi-Metal Holesaw Set for Metal/  
Wood Boards 16 mm-64 mm - 12 Pcs



**3834-95**



1350 g



1 3834-SET-95

3830-16-VIP, 3830-19-VIP, 3830-22-VIP, 3830-29-VIP, 3830-35-VIP, 3830-44-VIP, 3830-52-VIP, 3830-57-VIP, 3830-64-VIP



3834-ARBR-1130



3834-ARBR-11152



3834-DRL



Sandflex® Bi-Metal Holesaw Set 16 mm-83  
mm - 18 Pcs



**3834-SET-152**



3770 g



1 3834-SET-152

3830-16-VIP, 3830-19-VIP, 3830-22-VIP, 3830-25-VIP, 3830-32-VIP, 3830-35-VIP, 3830-44-VIP, 3830-51-VIP, 3830-57-VIP, 3830-60-VIP, 3830-65-VIP, 3830-68-VIP, 3830-73-VIP, 3830-76-VIP, 3830-83-VIP



3834-ARBR-930



3834-ARBR-9100



3834-DRLx 2



Superior™ Multi Construction Holesaws for Wood and Brick 19 mm-225 mm



**3833**

| 19 mm  | 1 | 3833-19-C  |  |
|--------|---|------------|--|
| 20 mm  | 1 | 3833-20-C  |  |
| 22 mm  | 1 | 3833-22-C  |  |
| 25 mm  | 1 | 3833-25-C  |  |
| 27 mm  | 1 | 3833-27-C  |  |
| 29 mm  | 1 | 3833-29-C  |  |
| 30 mm  | 1 | 3833-30-C  |  |
| 32 mm  | 1 | 3833-32-C  |  |
| 35 mm  | 1 | 3833-35-C  |  |
| 38 mm  | 1 | 3833-38-C  |  |
| 40 mm  | 1 | 3833-40-C  |  |
| 41 mm  | 1 | 3833-41-C  |  |
| 44 mm  | 1 | 3833-44-C  |  |
| 48 mm  | 1 | 3833-48-C  |  |
| 51 mm  | 1 | 3833-51-C  |  |
| 54 mm  | 1 | 3833-54-C  |  |
| 56 mm  | 1 | 3833-56-C  |  |
| 57 mm  | 1 | 3833-57-C  |  |
| 60 mm  | 1 | 3833-60-C  |  |
| 62 mm  | 1 | 3833-62-C  |  |
| 64 mm  | 1 | 3833-64-C  |  |
| 65 mm  | 1 | 3833-65-C  |  |
| 67 mm  | 1 | 3833-67-C  |  |
| 68 mm  | 1 | 3833-68-C  |  |
| 70 mm  | 1 | 3833-70-C  |  |
| 71 mm  | 1 | 3833-71-C  |  |
| 73 mm  | 1 | 3833-73-C  |  |
| 74 mm  | 1 | 3833-74-C  |  |
| 76 mm  | 1 | 3833-76-C  |  |
| 77 mm  | 1 | 3833-77-C  |  |
| 78 mm  | 1 | 3833-78-C  |  |
| 79 mm  | 1 | 3833-79-C  |  |
| 83 mm  | 1 | 3833-83-C  |  |
| 86 mm  | 1 | 3833-86-C  |  |
| 89 mm  | 1 | 3833-89-C  |  |
| 92 mm  | 1 | 3833-92-C  |  |
| 95 mm  | 1 | 3833-95-C  |  |
| 98 mm  | 1 | 3833-98-C  |  |
| 102 mm | 1 | 3833-102-C |  |
| 105 mm | 1 | 3833-105-C |  |
| 108 mm | 1 | 3833-108-C |  |
| 109 mm | 1 | 3833-109-C |  |
| 111 mm | 1 | 3833-111-C |  |
| 114 mm | 1 | 3833-114-C |  |
| 121 mm | 1 | 3833-121-C |  |
| 127 mm | 1 | 3833-127-C |  |
| 133 mm | 1 | 3833-133-C |  |
| 140 mm | 1 | 3833-140-C |  |
| 152 mm | 1 | 3833-152-C |  |
| 159 mm | 1 | 3833-159-C |  |
| 168 mm | 1 | 3833-168   |  |
| 177 mm | 1 | 3833-177   |  |
| 210 mm | 1 | 3833-210   |  |
| 225 mm | 1 | 3833-225   |  |

Superior™ Multi Construction Holesaw Set 32-83 mm - 6 pcs



**3833-PROMO-42**

| 1489 g | 1 | 3833-PROMO-42 |
|--------|---|---------------|

|  |  |
|--|--|
| 3833-32-C, 3833-51-C, 3833-76-C, 3833-83-C |  |
| 3834-ARBR-9100EL                           |  |
| 3834-UPSIZING                              |  |

Superior™ Multi Construction Holesaw Set 19 mm-64 mm - 10 Pcs



**3833-SET-101**

| 2.75 kg | 1 | 3833-SET-101 |
|---------|---|--------------|

|   |  |
|---|--|
| 3833-19-C, 3833-22-C, 3833-29-C, 3833-35-C, 3833-44-C, 3833-51-C, 3833-64-C |  |
| 3834-ARBR-930EL, 3834-ARBR-9100EL   |  |
| 3834-DRL-EL   |  |

Superior™ Multi Construction Holesaw Set 19 mm-86 mm - 14 Pcs



**3833-SET-201**

| 4.35 kg | 1 | 3833-SET-201 |
|---------|---|--------------|

|  |  |
|--|--|
| 3833-19-C, 3833-20-C, 3833-25-C, 3833-32-C, 3833-41-C, 3833-51-C, 3833-73-C, 3833-76-C, 3833-83-C, 3833-86-C |  |
| 3834-ARBR-930EL, 3834-ARBR-9100EL  |  |
| 3834-DRL-EL  |  |
| 3834-UPSIZING  |  |

Superior™ Multi Construction Holesaw Set 19 mm-83 mm - 14 Pcs



**3833-SET-202**

| 4.1 kg | 1 | 3833-SET-202 |
|--------|---|--------------|

|  |  |
|--|--|
| 3833-19-C, 3833-20-C, 3833-25-C, 3833-32-C, 3833-41-C, 3833-51-C, 3833-57-C, 3833-60-C, 3833-73-C, 3833-83-C |  |
| 3834-ARBR-930EL, 3834-ARBR-9100EL  |  |
| 3834-DRL-EL  |  |
| 3834-UPSIZING  |  |





Superior™ Multi Construction Holesaw Set  
19 mm-78 mm - 14 Pcs



**3833-SET-203**



4.65 kg



1 3833-SET-203

3833-19-C, 3833-22-C, 3833-54-C, 3833-56-C,  
3833-57-C, 3833-62-C, 3833-68-C, 3833-71-C,  
3833-74-C, 3833-78-C

3834-ARBR-930EL, 3834-ARBR-9100EL

3834-DRL-EL

3834-UPSIZE

Superior™ Multi Construction Holesaw Set  
22 mm-67 mm - 9 Pcs



**3833-SET-205**



2.81 kg



1 3833-SET-205

3833-22-C, 3833-35-C, 3833-44-C, 3833-51-C,  
3833-67-C

3834-ARBR-930EL, 3834-ARBR-9100EL

3834-DRL-EL

3834-UPSIZE

Superior™ Multi Construction Holesaw Set  
19 mm-76 mm - 15 Pcs



**3833-SET-208**



3.72 kg



1 3833-SET-208

3833-19-C, 3833-22-C, 3833-25-C, 3833-32-C,  
3833-35-C, 3833-38-C, 3833-44-C, 3833-51-C,  
3833-57-C, 3833-68-C, 3833-76-C

3834-ARBR-930EL, 3834-ARBR-9100EL

3834-DRL-EL

3834-UPSIZE

Superior™ Multi Construction Holesaw Set  
32 mm-86 mm - 10 Pcs



**3833-SET-204**



3.88 kg



1 3833-SET-204

3833-32-C, 3833-41-C, 3833-51-C, 3833-73-C,  
3833-76-C, 3833-83-C, 3833-86-C

3834-ARBR-9100EL

3834-DRL-EL

3834-UPSIZE

Superior™ Multi Construction Holesaw Set  
19 mm-83 mm - 14 Pcs



**3833-SET-207**



3.90 kg



1 3833-SET-207

3833-19-C, 3833-22-C, 3833-25-C, 3833-35-C,  
3833-44-C, 3833-51-C, 3833-64-C, 3833-67-C,  
3833-76-C, 3833-83-C

3834-ARBR-930EL, 3834-ARBR-9100EL

3834-DRL-EL

3834-UPSIZE

Superior™ Multi Construction Holesaw Set  
25 mm-114 mm - 12 Pcs



**3833-SET-301**



4.38 kg



1 3833-SET-301

3833-25-C, 3833-32-C, 3833-35-C, 3833-51-C,  
3833-54-C, 3833-76-C, 3833-92-C, 3833-114-C

3834-ARBR-930EL, 3834-ARBR-9100EL

3834-DRL-EL

3834-UPSIZE



Superior™ Multi Construction Holesaw Set  
51 mm-111 mm - 7 Pcs



**3833-SET-302**

|         |   |              |
|---------|---|--------------|
|         |   |              |
| 3.51 kg | 1 | 3833-SET-302 |

|   |  |
|---|--|
| 3833-51-C, 3833-76-C, 3833-86-C, 3833-111-C |  |
| 3834-ARBR-9100EL                            |  |
| 3834-DRL-EL                                 |  |
| 3834-UPSIZ                                  |  |

Superior™ Multi Construction Holesaw Set  
35 mm-114 mm - 11 Pcs



**3833-SET-303**

|         |   |              |
|---------|---|--------------|
|         |   |              |
| 4.17 kg | 1 | 3833-SET-303 |

|  |  |
|--|--|
| 3833-35-C, 3833-40-C, 3833-51-C, 3833-57-C,<br>3833-60-C, 3833-74-C, 3833-83-C, 3833-105-C |  |
| 3834-ARBR-9100EL   |  |
| 3834-DRL-EL  |  |
| 3834-UPSIZ   |  |

Superior™ Multi Construction Holesaw Set  
19 mm-114 mm - 13 Pcs



**3833-SET-304**

|         |   |              |
|---------|---|--------------|
|         |   |              |
| 4.20 kg | 1 | 3833-SET-304 |

|  |  |
|--|--|
| 3833-19-C, 3833-25-C, 3833-32-C, 3833-35-C,<br>3833-51-C, 3833-54-C, 3833-76-C, 3833-92-C,<br>3833-114-C |  |
| 3834-ARBR-930EL, 3834-ARBR-9100EL  |  |
| 3834-DRL-EL  |  |
| 3834-UPSIZ   |  |

Carbide Tipped Holesaws for Fibreglass/  
Masonry 14 mm-152 mm



**3832**

|       |   |         |
|-------|---|---------|
|       |   |         |
| 14 mm | 6 | 3832-14 |
| 16 mm | 6 | 3832-16 |
| 17 mm | 6 | 3832-17 |
| 19 mm | 6 | 3832-19 |

|        |   |          |
|--------|---|----------|
|        |   |          |
| 20 mm  | 6 | 3832-20  |
| 21 mm  | 6 | 3832-21  |
| 22 mm  | 6 | 3832-22  |
| 24 mm  | 6 | 3832-24  |
| 25 mm  | 6 | 3832-25  |
| 27 mm  | 6 | 3832-27  |
| 29 mm  | 6 | 3832-29  |
| 30 mm  | 6 | 3832-30  |
| 32 mm  | 6 | 3832-32  |
| 33 mm  | 6 | 3832-33  |
| 35 mm  | 6 | 3832-35  |
| 37 mm  | 6 | 3832-37  |
| 38 mm  | 6 | 3832-38  |
| 40 mm  | 6 | 3832-40  |
| 41 mm  | 6 | 3832-41  |
| 43 mm  | 6 | 3832-43  |
| 44 mm  | 6 | 3832-44  |
| 46 mm  | 6 | 3832-46  |
| 48 mm  | 6 | 3832-48  |
| 51 mm  | 6 | 3832-51  |
| 52 mm  | 4 | 3832-52  |
| 54 mm  | 4 | 3832-54  |
| 56 mm  | 4 | 3832-56  |
| 57 mm  | 4 | 3832-57  |
| 59 mm  | 4 | 3832-59  |
| 60 mm  | 4 | 3832-60  |
| 64 mm  | 4 | 3832-64  |
| 65 mm  | 4 | 3832-65  |
| 67 mm  | 4 | 3832-67  |
| 68 mm  | 4 | 3832-68  |
| 70 mm  | 4 | 3832-70  |
| 73 mm  | 4 | 3832-73  |
| 76 mm  | 4 | 3832-76  |
| 79 mm  | 4 | 3832-79  |
| 83 mm  | 4 | 3832-83  |
| 86 mm  | 4 | 3832-86  |
| 89 mm  | 4 | 3832-89  |
| 92 mm  | 4 | 3832-92  |
| 95 mm  | 4 | 3832-95  |
| 98 mm  | 4 | 3832-98  |
| 102 mm | 4 | 3832-102 |
| 105 mm | 4 | 3832-105 |
| 108 mm | 4 | 3832-108 |
| 111 mm | 4 | 3832-111 |
| 114 mm | 4 | 3832-114 |
| 121 mm | 1 | 3832-121 |
| 127 mm | 1 | 3832-127 |
| 133 mm | 1 | 3832-133 |
| 140 mm | 1 | 3832-140 |
| 146 mm | 1 | 3832-146 |
| 152 mm | 1 | 3832-152 |



Carbide Tipped Holesaws for Stainless Steel 16–127 mm



**3832-C**

| Size (mm) | Quantity | Part Number |
|-----------|----------|-------------|
| 16 mm     | 1        | 3832-16-C   |
| 19 mm     | 1        | 3832-19-C   |
| 20 mm     | 1        | 3832-20-C   |
| 22 mm     | 1        | 3832-22-C   |
| 24 mm     | 1        | 3832-24-C   |
| 25 mm     | 1        | 3832-25-C   |
| 29 mm     | 1        | 3832-29-C   |
| 30 mm     | 1        | 3832-30-C   |
| 32 mm     | 1        | 3832-32-C   |
| 35 mm     | 1        | 3832-35-C   |
| 38 mm     | 1        | 3832-38-C   |
| 41 mm     | 1        | 3832-41-C   |
| 44 mm     | 1        | 3832-44-C   |
| 46 mm     | 1        | 3832-46-C   |
| 48 mm     | 1        | 3832-48-C   |
| 51 mm     | 1        | 3832-51-C   |
| 54 mm     | 1        | 3832-54-C   |
| 57 mm     | 1        | 3832-57-C   |
| 60 mm     | 1        | 3832-60-C   |
| 64 mm     | 1        | 3832-64-C   |
| 73 mm     | 1        | 3832-73-C   |
| 76 mm     | 1        | 3832-76-C   |
| 83 mm     | 1        | 3832-83-C   |
| 86 mm     | 1        | 3832-86-C   |
| 92 mm     | 1        | 3832-92-C   |
| 102 mm    | 1        | 3832-102-C  |
| 114 mm    | 1        | 3832-114-C  |
| 127 mm    | 1        | 3832-127-C  |

Carbide Tipped Holesaw Sets for Stainless Steel 25 mm -114 mm - 12 Pcs



**3832-SET-84-ES**

|        |   |                |
|--------|---|----------------|
| 3600 g | 1 | 3832-SET-84-ES |
|--------|---|----------------|

|   |  |
|---|--|
| 3832-25-C, 3832-30-C, 3832-35-C, 3832-51-C, 3832-54-C, 3832-76-C, 3832-92-C, 3832-114-C |  |
| 3834-ARBR-9100ESM, 3834-ARBR-930ESM   |  |
| 3834-DRL-HSS-ES   |  |
| 3834-UPSIZING   |  |

Carbide Tipped Holesaw Sets for Stainless Steel 16 mm-114 mm - 20 Pcs



**3832-SET-164-ES**

|        |   |                 |
|--------|---|-----------------|
| 4800 g | 1 | 3832-SET-164-ES |
|--------|---|-----------------|

|   |  |
|---|--|
| 3832-16-C, 3832-20-C, 3832-25-C, 3832-32-C, 3832-35-C, 3832-41-C, 3832-44-C, 3832-46-C, 3832-51-C, 3832-54-C, 3832-73-C, 3832-76-C, 3832-83-C, 3832-86-C, 3832-92-C, 3832-114-C |  |
| 3834-ARBR-9100ESM, 3834-ARBR-930ESM   |  |
| 3834-DRL-HSS-ES   |  |
| 3834-UPSIZING   |  |

Holesaw Set, Mixed 35–114 mm - 10 pcs



**3835-SET-64**

|    |        |   |             |
|----|--------|---|-------------|
| 10 | 3870 g | 1 | 3835-SET-64 |
|----|--------|---|-------------|

|   |  |
|---|--|
| 3830-35-C, 3830-73-C                        |  |
| 3833-35-C, 3833-73-C, 3833-76-C, 3833-114-C |  |
| 3834-ARBR-9100QC-C                          |  |
| 3834-ARBR-9100EL                            |  |
| 3834-DRL-EL                                 |  |
| 3834-DRL                                    |  |

Holesaw Set, Mixed 12–86 mm - 18 pcs



**3835-SET-711**

|    |        |   |              |
|----|--------|---|--------------|
| 18 | 3680 g | 1 | 3835-SET-711 |
|----|--------|---|--------------|

|   |  |
|---|--|
| 3830-35-C, 3830-41-C, 3830-51-C, 3830-73-C, 3830-76-C, 3830-83-C, 3830-86-C     |  |
| 9629-12, 9629-14, 9629-16, 9629-18, 9629-20, 9629-22, 9629-25, 9629-28, 9629-32 |  |
| 3834-ARBR-9100ESM   |  |
| 3834-DRL-HSS-ES   |  |

Arbors with Quick-Eject Function - Saves time and energy



**3834-ARBR-EL/ES**

|           |        |   |                   |
|-----------|--------|---|-------------------|
| 19-30 mm  | 8.5 mm | 1 | 3834-ARBR-930EL   |
| 32-159 mm | 8.5 mm | 1 | 3834-ARBR-9100EL  |
| 16-30 mm  | 8.5 mm | 1 | 3834-ARBR-930ESM  |
| 32-152 mm | 8.5 mm | 1 | 3834-ARBR-9100ESM |

Pilot Drills for Long Quick-Eject Arbors



**3834-DRL-EL**

|         |        |   |             |
|---------|--------|---|-------------|
| 6.35 mm | 202 mm | 1 | 3834-DRL-EL |
|---------|--------|---|-------------|

### Pilot Drills for Short Quick-Eject Arbors



#### 3834-DRL-HSS-ES

| Ø       | L      | Icons | Part No.          |
|---------|--------|-------|-------------------|
| 6.35 mm | 138 mm |       | 1 3834-DRL-ES     |
| 6.35 mm | 138 mm |       | 1 3834-DRL-HSS-ES |

### Upsize Adaptors for Enlarging Existing Holes



#### 3834-upsize

| L       | Icons | Part No.      |
|---------|-------|---------------|
| 20.5 mm |       | 1 3834-UPSIZE |

### Arbors for small holesaws 14-30mm



#### 3834-ARBR

| Ø        | Drive   | Length | Icons | Part No.           |
|----------|---------|--------|-------|--------------------|
| 14-30 mm | 6.4 mm  |        |       | 1 3834-ARBR-630    |
| 14-30 mm | 6.4 mm  |        |       | 1 3834-ARBR-630-C  |
| 14-30 mm | 6.4 mm  |        |       | 1 3834-ARBR-730    |
| 14-30 mm | 6.4 mm  |        |       | 1 3834-ARBR-730-C  |
| 14-30 mm | 8.5 mm  |        |       | 1 3834-ARBR-930    |
| 14-30 mm | 8.5 mm  |        |       | 1 3834-ARBR-930-C  |
| 14-30 mm | 11.1 mm |        |       | 4 3834-ARBR-1130   |
| 14-30 mm | 11.1 mm |        |       | 1 3834-ARBR-1130-C |

### Arbors with Quick-Change function



#### 3834-ARBR-QC

| Ø         | Length  | Icons | Part No.              |
|-----------|---------|-------|-----------------------|
| 32-152 mm | 8.5 mm  |       | 1 3834-ARBR-9100      |
| 32-152 mm | 8.5 mm  |       | 1 3834-ARBR-9100-C    |
| 32-152 mm | 8.5 mm  |       | 1 3834-ARBR-9100QC-C  |
| 32-152 mm | 8.5 mm  |       | 1 3834-ARBR-9100QC-C  |
| 32-210 mm | 11.1 mm |       | 1 3834-ARBR-11152     |
| 32-210 mm | 11.1 mm |       | 1 3834-ARBR-11152-C   |
| 32-210 mm | 11.1 mm |       | 1 3834-ARBR-11152QC   |
| 32-210 mm | 11.1 mm |       | 1 3834-ARBR-11152QC-C |
| 32-210 mm | 15.4 mm |       | 1 3834-ARBR-16152     |
| 32-210 mm | 15.4 mm |       | 1 3834-ARBR-16152QC   |

### Arbors with SDS+ Drive



#### 3834-ARBR-SD

| Ø         | Drive   | Length | Icons | Part No.            |
|-----------|---------|--------|-------|---------------------|
| 14-30 mm  | SDS+ mm |        |       | 1 3834-ARBR-SD30    |
| 32-210 mm | SDS+ mm |        |       | 1 3834-ARBR-SD152QC |

### HSS Pilot Drills for Arbors



#### 3834-DRL

| Ø       | L     | Icons | Part No.   |
|---------|-------|-------|------------|
| 6.35 mm | 81 mm |       | 1 3834-DRL |

### Carbide Tipped Pilot Drills for Arbors



#### 3834-DRL-CT/L

| Ø       | L      | Icons | Part No.      |
|---------|--------|-------|---------------|
| 6.35 mm | 81 mm  |       | 1 3834-DRL-CT |
| 6.35 mm | 114 mm |       | 1 3834-DRL-L  |

### Arbor Extensions



#### 3834-EXT

| Ø       | L      | Icons | Part No.     |
|---------|--------|-------|--------------|
| 11.1 mm | 330 mm |       | 1 3834-EXT-1 |
| 8.5 mm  | 330 mm |       | 1 3834-EXT-2 |

### Ejector Spring for arbors



#### 3834-ES

| Weight | Icons | Part No.  |
|--------|-------|-----------|
| 10 g   |       | 1 3834-ES |



Arbor Adaptor for 3834-ARBR-630, 730, 930 and 1130



**3834-ADP**

|      |   |          |
|------|---|----------|
|      |   |          |
| 20 g | 1 | 3834-ADP |

Spare Screws for Arbors



**3834-SCREWS**

|     |   |                |
|-----|---|----------------|
|     |   |                |
| 9 g | 1 | 3834-M6X29-SET |
| 9 g | 1 | 3834-M8X5-SET  |
| 9 g | 1 | 3834-M8X6-SET  |
| 9 g | 1 | 3834-M8X10-SET |

**SABRE SAWBLADES**

Sandflex® Bi-Metal Sabre Sawblade Set for Metal



**3940-M**

|        |    |    |                    |
|--------|----|----|--------------------|
|        |    |    |                    |
| 100 mm | 14 | 10 | 3940-100-14-ST-2P  |
| 100 mm | 14 | 5  | 3940-100-14-ST-5P  |
| 100 mm | 14 | 1  | 3940-100-14-ST-10P |
| 100 mm | 18 | 10 | 3940-100-18-ST-2P  |
| 100 mm | 18 | 5  | 3940-100-18-ST-5P  |
| 100 mm | 18 | 1  | 3940-100-18-ST-10P |
| 150 mm | 14 | 5  | 3940-150-14-ST-2P  |
| 150 mm | 14 | 5  | 3940-150-14-ST-5P  |

|        |    |    |                     |
|--------|----|----|---------------------|
|        |    |    |                     |
| 150 mm | 14 | 1  | 3940-150-14-ST-10P  |
| 150 mm | 14 | 1  | 3940-150-14-ST-100P |
| 150 mm | 18 | 10 | 3940-150-18-ST-2P   |
| 150 mm | 18 | 5  | 3940-150-18-ST-5P   |
| 150 mm | 18 | 1  | 3940-150-18-ST-10P  |
| 150 mm | 18 | 1  | 3940-150-18-ST-100P |
| 228 mm | 14 | 5  | 3940-228-14-ST-2P   |
| 228 mm | 14 | 5  | 3940-228-14-ST-5P   |
| 228 mm | 14 | 1  | 3940-228-14-ST-10P  |
| 228 mm | 14 | 1  | 3940-228-14-ST-100P |
| 228 mm | 18 | 10 | 3940-228-18-ST-2P   |
| 228 mm | 18 | 5  | 3940-228-18-ST-5P   |
| 228 mm | 18 | 1  | 3940-228-18-ST-10P  |
| 228 mm | 18 | 1  | 3940-228-18-ST-100P |
| 300 mm | 14 | 5  | 3940-300-14-ST-2P   |
| 300 mm | 14 | 5  | 3940-300-14-ST-5P   |
| 300 mm | 14 | 1  | 3940-300-14-ST-10P  |
| 300 mm | 14 | 1  | 3940-300-14-ST-100P |
| 300 mm | 18 | 10 | 3940-300-18-ST-2P   |
| 300 mm | 18 | 5  | 3940-300-18-ST-5P   |
| 300 mm | 18 | 1  | 3940-300-18-ST-10P  |
| 300 mm | 18 | 1  | 3940-300-18-ST-100P |

Sandflex® Bi-Metal Sabre Sawblade Set for Heavy Metal



**3940-HM**

|        |      |    |                       |
|--------|------|----|-----------------------|
|        |      |    |                       |
| 150 mm | 8/12 | 10 | 3940-150-8/12-ST-2P   |
| 150 mm | 8/12 | 5  | 3940-150-8/12-ST-5P   |
| 150 mm | 8/12 | 1  | 3940-150-8/12-ST-10P  |
| 150 mm | 8/12 | 1  | 3940-150-8/12-ST-100P |
| 228 mm | 8/12 | 10 | 3940-228-8/12-ST-2P   |
| 228 mm | 8/12 | 5  | 3940-228-8/12-ST-5P   |
| 228 mm | 8/12 | 1  | 3940-228-8/12-ST-10P  |
| 228 mm | 8/12 | 1  | 3940-228-8/12-ST-100P |
| 150 mm | 10   | 10 | 3940-150-10-HST-2P    |
| 150 mm | 10   | 5  | 3940-150-10-HST-5P    |
| 150 mm | 10   | 1  | 3940-150-10-HST-10P   |
| 150 mm | 10   | 1  | 3940-150-10-ST-100P   |
| 150 mm | 10   | 10 | 3940-150-10-ST-2P     |
| 150 mm | 10   | 5  | 3940-150-10-ST-5P     |
| 150 mm | 10   | 1  | 3940-150-10-ST-10P    |
| 150 mm | 14   | 10 | 3940-150-14-HST-2P    |
| 150 mm | 14   | 5  | 3940-150-14-HST-5P    |
| 150 mm | 14   | 1  | 3940-150-14-HST-10P   |
| 150 mm | 18   | 10 | 3940-150-18-HST-2P    |
| 150 mm | 18   | 5  | 3940-150-18-HST-5P    |
| 150 mm | 18   | 1  | 3940-150-18-HST-10P   |
| 228 mm | 10   | 10 | 3940-228-10-HST-2P    |
| 228 mm | 10   | 5  | 3940-228-10-HST-5P    |
| 228 mm | 10   | 1  | 3940-228-10-HST-10P   |
| 228 mm | 10   | 1  | 3940-228-10-HST-100P  |
| 228 mm | 10   | 10 | 3940-228-10-ST-2P     |
| 228 mm | 10   | 5  | 3940-228-10-ST-5P     |
| 228 mm | 10   | 1  | 3940-228-10-ST-10P    |
| 228 mm | 10   | 1  | 3940-228-10-ST-100P   |

|        |    |    |                     |
|--------|----|----|---------------------|
|        |    |    |                     |
| 228 mm | 14 | 10 | 3940-228-14-HST-2P  |
| 228 mm | 14 | 5  | 3940-228-14-HST-5P  |
| 228 mm | 14 | 1  | 3940-228-14-HST-10P |
| 228 mm | 18 | 10 | 3940-228-18-HST-2P  |
| 228 mm | 18 | 5  | 3940-228-18-HST-5P  |
| 228 mm | 18 | 1  | 3940-228-18-HST-10P |
| 300 mm | 10 | 10 | 3940-300-10-HST-2P  |
| 300 mm | 10 | 5  | 3940-300-10-HST-5P  |
| 300 mm | 10 | 1  | 3940-300-10-HST-10P |
| 300 mm | 14 | 10 | 3940-300-14-HST-2P  |
| 300 mm | 14 | 5  | 3940-300-14-HST-5P  |
| 300 mm | 14 | 1  | 3940-300-14-HST-10P |
| 300 mm | 18 | 10 | 3940-300-18-HST-2P  |
| 300 mm | 18 | 5  | 3940-300-18-HST-5P  |
| 300 mm | 18 | 1  | 3940-300-18-HST-10P |

Sandflex® Bi-Metal Sabre Sawblade Set for Fine Metal



**3940-FM**

|        |    |    |                     |
|--------|----|----|---------------------|
|        |    |    |                     |
| 100 mm | 24 | 10 | 3940-100-24-ST-2P   |
| 100 mm | 24 | 5  | 3940-100-24-ST-5P   |
| 100 mm | 24 | 1  | 3940-100-24-ST-10P  |
| 150 mm | 24 | 5  | 3940-150-24-ST-2P   |
| 150 mm | 24 | 5  | 3940-150-24-ST-5P   |
| 150 mm | 24 | 1  | 3940-150-24-ST-10P  |
| 150 mm | 24 | 1  | 3940-150-24-ST-100P |

Sandflex® Bi-Metal Sabre Sawblade Set for Precision Metal



**3940-PM**

|        |    |    |                   |
|--------|----|----|-------------------|
|        |    |    |                   |
| 100 mm | 14 | 10 | 3940-100-14-SC-2P |
| 100 mm | 14 | 5  | 3940-100-14-SC-5P |
| 100 mm | 18 | 10 | 3940-100-18-SC-2P |
| 100 mm | 18 | 5  | 3940-100-18-SC-5P |
| 100 mm | 24 | 10 | 3940-100-24-SC-2P |
| 100 mm | 24 | 5  | 3940-100-24-SC-5P |

Sabre Saw Tungsten Carbide Tipped Blades for Heavy Duty Metal



**3946-C HM**

| Length | Teeth | Quantity | Part Number        |
|--------|-------|----------|--------------------|
| 300 mm | 8     | 1        | 3946-300-8-HST-10P |
| 150 mm | 8     | 10       | 3946-150-8-HST-1P  |
| 228 mm | 8     | 10       | 3946-228-8-HST-1P  |
| 300 mm | 8     | 10       | 3946-300-8-HST-1P  |

10P = 10 pieces

Sabre Saw Tungsten Carbide Tipped Blades for Stainless Steel



**3946-C SS**

| Length | Teeth | Quantity | Part Number        |
|--------|-------|----------|--------------------|
| 150 mm | 10    | 10       | 3946-150-10-HST-1P |
| 228 mm | 10    | 10       | 3946-228-10-HST-1P |
| 300 mm | 10    | 10       | 3946-300-10-HST-1P |

Sabre Saw Diamond Grit Blades For Cast Iron And Ceramics



**3946-D CI**

| Length | Teeth | Quantity | Part Number       |
|--------|-------|----------|-------------------|
| 100 mm | Grit  | 10       | 3946-100-DG-ST-2P |
| 150 mm | Grit  | 10       | 3946-150-DG-ST-2P |

Car Body Sandflex® Bi-Metal Reciprocating Sawblades



**3845**

| Length  | Teeth | Quantity | Part Number |
|---------|-------|----------|-------------|
| 91.5 mm | 18    | 1        | 3845-18-10P |
| 91.5 mm | 24    | 1        | 3845-24-10P |
| 90 mm   | 32    | 1        | 3845-32-10P |

Sandflex® Bi-Metal Sabre Sawblades for Wood and Metal



**3940-WM**

| Length | Teeth | Quantity | Part Number           |
|--------|-------|----------|-----------------------|
| 150 mm | 4/6   | 10       | 3940-150-4/6-SC-2P    |
| 150 mm | 4/6   | 5        | 3940-150-4/6-SC-5P    |
| 150 mm | 4/6   | 1        | 3940-150-4/6-SC-10P   |
| 150 mm | 5/8   | 10       | 3940-150-5/8-SL-2P    |
| 150 mm | 5/8   | 5        | 3940-150-5/8-SL-5P    |
| 150 mm | 5/8   | 1        | 3940-150-5/8-SL-10P   |
| 150 mm | 5/8   | 1        | 3940-150-5/8-SL-100P  |
| 150 mm | 6     | 10       | 3940-150-6-ST-2P      |
| 150 mm | 6     | 5        | 3940-150-6-ST-5P      |
| 150 mm | 6     | 1        | 3940-150-6-ST-10P     |
| 228 mm | 6     | 10       | 3940-228-6-SL-2P      |
| 228 mm | 6     | 5        | 3940-228-6-SL-5P      |
| 228 mm | 6     | 1        | 3940-228-6-SL-10P     |
| 300 mm | 6     | 10       | 3940-300-6-SL-2P      |
| 300 mm | 6     | 5        | 3940-300-6-SL-5P      |
| 300 mm | 6     | 1        | 3940-300-6-SL-10P     |
| 300 mm | 8/12  | 5        | 3940-300-8/12-SL-2P   |
| 300 mm | 8/12  | 5        | 3940-300-8/12-SL-5P   |
| 300 mm | 8/12  | 1        | 3940-300-8/12-SL-10P  |
| 300 mm | 8/12  | 1        | 3940-300-8/12-SL-100P |

Sandflex® Bi-Metal Sabre Sawblades for Fire Fighters and Rescuers



**3940-FR**

| Length | Teeth | Quantity | Part Number          |
|--------|-------|----------|----------------------|
| 228 mm | 10    | 10       | 3940-228-10-DSL-2P   |
| 228 mm | 10    | 5        | 3940-228-10-DSL-5P   |
| 228 mm | 10    | 1        | 3940-228-10-DSL-10P  |
| 228 mm | 10    | 1        | 3940-228-10-DSL-100P |

Sandflex® Bi-Metal Sabre Sawblades for Demolition



**3940-D**

| Length | Teeth | Quantity | Part Number          |
|--------|-------|----------|----------------------|
| 150 mm | 5/8   | 5        | 3940-150-5/8-DSL-2P  |
| 150 mm | 5/8   | 5        | 3940-150-5/8-DSL-5P  |
| 150 mm | 5/8   | 1        | 3940-150-5/8-DSL-10P |
| 228 mm | 5/8   | 10       | 3940-228-5/8-DSL-2P  |
| 228 mm | 5/8   | 5        | 3940-228-5/8-DSL-5P  |
| 228 mm | 5/8   | 1        | 3940-228-5/8-DSL-10P |
| 300 mm | 5/8   | 10       | 3940-300-5/8-DSL-2P  |
| 300 mm | 5/8   | 5        | 3940-300-5/8-DSL-5P  |
| 300 mm | 5/8   | 1        | 3940-300-5/8-DSL-10P |

Sandflex® Bi-Metal Sabre Sawblades for Pallet Repair



**3940-PR**

| Length | Teeth | Quantity | Part Number              |
|--------|-------|----------|--------------------------|
| 228 mm | 10/14 | 1        | 3940-228-10/14-PR13-10P  |
| 228 mm | 10/14 | 1        | 3940-228-10/14-PR09-10P  |
| 228 mm | 10/14 | 1        | 3940-228-10/14-PR09-100P |
| 228 mm | 10/14 | 1        | 3940-228-10/14-PR13-100P |
| 228 mm | 8/12  | 1        | 3940-228-8/12-PR13-100P  |
| 228 mm | 10    | 1        | 3940-228-10-PR09-100P    |





Sabre Saw Tungsten Carbide Tipped Blades for Wood & Nails



**3946-C\_WM**

| Length | Teeth | Quantity | Part Number       |
|--------|-------|----------|-------------------|
| 150 mm | 6     | 10       | 3946-150-6-DSL-1P |
| 228 mm | 6     | 10       | 3946-228-6-DSL-1P |
| 300 mm | 6     | 10       | 3946-300-6-DSL-1P |

Sabre Saw HCS Blades for Wood and Plastic



**3942-WP**

| Length | Teeth | Quantity | Part Number         |
|--------|-------|----------|---------------------|
| 228 mm | 11    | 10       | 3942-228-11-HSL-2P  |
| 228 mm | 11    | 5        | 3942-228-11-HSL-5P  |
| 228 mm | 11    | 1        | 3942-228-11-HSL-10P |

Reciprocating Curved Saw Blade for Medium Cut



**3943-C30-JT-M**

| Length | Teeth | Quantity | Part Number   |
|--------|-------|----------|---------------|
| 323 mm | 13 in | 10       | 3943-C30-JT-M |
| 373 mm | 15 in | 10       | 3943-C35-JT-M |

Sabre Saw HCS Blades for Wood



**3942-W**

| Length | Teeth | Quantity | Part Number        |
|--------|-------|----------|--------------------|
| 228 mm | 7     | 10       | 3942-228-7-HSL-2P  |
| 228 mm | 7     | 5        | 3942-228-7-HSL-5P  |
| 228 mm | 7     | 1        | 3942-228-7-HSL-10P |
| 300 mm | 7     | 10       | 3942-300-7-HSL-2P  |
| 300 mm | 7     | 5        | 3942-300-7-HSL-5P  |
| 300 mm | 7     | 1        | 3942-300-7-HSL-10P |

Sandflex® Bi-Metal Sabre Sawblades for Plaster and Boards



**3942-PB**

| Length | Teeth | Quantity | Part Number       |
|--------|-------|----------|-------------------|
| 150 mm | 7     | 10       | 3942-150-7-SL-2P  |
| 150 mm | 7     | 5        | 3942-150-7-SL-5P  |
| 150 mm | 7     | 1        | 3942-150-7-SL-10P |
| 228 mm | 7     | 10       | 3942-228-7-SL-2P  |
| 228 mm | 7     | 5        | 3942-228-7-SL-5P  |
| 228 mm | 7     | 1        | 3942-228-7-SL-10P |
| 300 mm | 7     | 10       | 3942-300-7-SL-2P  |
| 300 mm | 7     | 5        | 3942-300-7-SL-5P  |
| 300 mm | 7     | 1        | 3942-300-7-SL-10P |

Reciprocating Long Curved Saw Blade for Coarse Cut



**3943-C35-JT-C**

| Length | Teeth | Quantity | Part Number   |
|--------|-------|----------|---------------|
| 373 mm | 15 in | 10       | 3943-C35-JT-C |

Sabre Saw HCS Blades for Coarse Wood



**3942-CW**

| Length | Teeth | Quantity | Part Number        |
|--------|-------|----------|--------------------|
| 228 mm | 5     | 10       | 3942-228-5-HSL-2P  |
| 228 mm | 5     | 5        | 3942-228-5-HSL-5P  |
| 228 mm | 5     | 1        | 3942-228-5-HSL-10P |
| 300 mm | 5     | 10       | 3942-300-5-HSL-2P  |
| 300 mm | 5     | 5        | 3942-300-5-HSL-5P  |
| 300 mm | 5     | 1        | 3942-300-5-HSL-10P |

Reciprocating Curved Saw Blade for Fine Cut



**3943-C30-JT-F**

| Length | Teeth | Quantity | Part Number   |
|--------|-------|----------|---------------|
| 323 mm | 13 in | 10       | 3943-C30-JT-F |

Reciprocating Straight Saw Blade for Fine Cut



**3943-S20-JT-F**

| Length | Teeth | Quantity | Part Number   |
|--------|-------|----------|---------------|
| 228 mm | 9 in  | 10       | 3943-S20-JT-F |

Reciprocating Straight Saw Blade for Coarse Cut



**3943-R28-UT-C-2P**



300 mm 12 in 10 3943-R28-UT-C-2P

Sandflex® Bi-Metal Sabre Sawblades Set for Heavy Metal and Demolition - 5 Pcs



**3940-HDD-SET-5P**



5 222 g 5 3940-HDD-SET-5P

3940-150-5/8-DSL, 3940-228-5/8-DSL, 3940-228-10-DSL, 3940-150-14-HST, 3940-228-14-HST, 3940-150-5/8-DSL, 3940-228-5/8-DSL, 3940-228-10-DSL, 3940-150-14-HST, 3940-228-14-HST

Sabre Sawblades Set for Wood and Metal - 12 Pcs



**3940-MIX-SET-12P**



12 480 g 6 3940-MIX-SET-12P

Sandflex® Bi-Metal Sabre Sawblades Set for Metal - 5 Pcs



**3940-METAL-SET-5P**

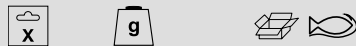

5 125 g 5 3940-METAL-SET-5P

3940-150-14-ST, 3940-150-18-ST, 3940-150-24-ST, 3940-228-18-ST, 3940-228-14-ST

Sabre Sawblades Set for Wood and Metal - 5 Pcs



**3940-MIX-SET-5P**



5 150 g 5 3940-MIX-SET-5P

3940-100-24-SC, 3940-150-18-ST, 3940-150-14-ST, 3940-228-6-SL, 3942-228-7-HSL, 3940-100-24-SC, 3940-150-18-ST, 3940-150-14-ST, 3940-228-6-SL, 3942-228-7-HSL

Sabre Sawblades Set for Wood - 5 Pcs



**3942-WOOD-SET-5P**



5 191 g 5 3942-WOOD-SET-5P

3940-228-6-SL, 3942-228-11-HSL, 2x 3942-228-7-HSL, 3942-150-7-SL, 3940-228-6-SL, 3942-228-11-HSL, 2x 3942-228-7-HSL, 3942-150-7-SL

Sandflex® Bi-Metal Sabre Sawblades Set for Metal - 12 Pcs



**3940-METAL-SET-12P**



12 460 g 6 3940-METAL-SET-12P

Sabre Sawblades Set for Plaster Wood and Metal - 10 Pcs



**3940-MIX-SET-10P**



10 245 g 4 3940-MIX-SET-10P

3940-100-24-SC, 3940-100-18-SC, 3940-150-24-ST, 3940-150-18-ST, 3940-150-14-ST, 3940-150-10-ST, 3940-228-6-SL, 3942-228-11-HSL, 3942-228-7-HSL, 3942-150-7-SL

Sabre Sawblades Set for Wood - 12 Pcs



**3942-WOOD-SET-12P**



12 525 g 6 3942-WOOD-SET-12P



Sabre Saw Stainless Steel Blades for Meat and Ice



**3944**

|        |   |    |                    |
|--------|---|----|--------------------|
|        |   |    |                    |
| 300 mm | 4 | 10 | 3944-300-3-MEAT-1P |

| L      |    |   |            |
|--------|----|---|------------|
| 77 mm  | 21 | 1 | 91-512-5P  |
| 77 mm  | 21 | 1 | 91-512-25P |
| 77 mm  | 21 | 1 | 91-517-5P  |
| 77 mm  | 13 | 1 | 91-522-5P  |
| 132 mm | 25 | 1 | 91-611-5P  |
| 77 mm  | 21 | 1 | 91-612-5P  |
| 77 mm  | 13 | 1 | 91-622-5P  |
| 132 mm | 14 | 1 | 91-7V1-5P  |

Sabre Saw Tungsten Carbide Tipped Blades for Stone Materials



**3946-CT**

|        |   |   |                  |
|--------|---|---|------------------|
|        |   |   |                  |
| 150 mm | 6 | 5 | 3946-150-6-SL-1P |
| 228 mm | 3 | 5 | 3946-228-3-ST-1P |

T-Shank Jigsaw Blades for Wood and Metal Cutting



**91-WM**

| L      |       |   |            |
|--------|-------|---|------------|
| 132 mm | 10/14 | 1 | 91-4PWM-5P |
| 100 mm | 10/14 | 1 | 91-623-5P  |

Sabre Saw Tungsten Carbide Tipped Blades for Bricks, LECA and Aerated Concrete



**3946-C\_B**

|        |   |    |                  |
|--------|---|----|------------------|
|        |   |    |                  |
| 300 mm | 2 | 10 | 3946-300-2-CB-1P |
| 457 mm | 2 | 10 | 3946-457-2-CB-1P |

T-Shank Jigsaw Blades for Wood Cutting



**91-W**

| L      |    |   |             |
|--------|----|---|-------------|
| 117 mm | 10 | 1 | 91-2PW-5P   |
| 132 mm | 8  | 1 | 91-434-5P   |
| 105 mm | 6  | 1 | 91-444-5P   |
| 100 mm | 8  | 1 | 91-023-5P   |
| 77 mm  | 12 | 1 | 91-027-5P   |
| 100 mm | 6  | 1 | 91-143-5P   |
| 100 mm | 6  | 1 | 91-143-25P  |
| 100 mm | 6  | 1 | 91-143-100P |
| 100 mm | 6  | 1 | 91-148-5P   |
| 100 mm | 10 | 1 | 91-223-5P   |
| 100 mm | 10 | 1 | 91-226-5P   |
| 132 mm | 6  | 1 | 91-233-5P   |
| 100 mm | 6  | 1 | 91-243-5P   |
| 77 mm  | 19 | 1 | 91-412-5P   |
| 100 mm | 6  | 1 | 91-443-5P   |

**JIGSAW BLADES**

T-Shank Jigsaw Blades for Metal Cutting



**91-M**

|        |       |   |           |
|--------|-------|---|-----------|
|        |       |   |           |
| 100 mm | 15/23 | 1 | 91-3PM-5P |
| 100 mm | 8     | 1 | 91-433-5P |
| 77 mm  | 36    | 1 | 91-502-5P |

Jigsaw Blade Set for Metal - 10 pcs



**91-METAL-10P**

|    |  |   |              |
|----|--|---|--------------|
|    |  |   |              |
| 10 |  | 1 | 91-METAL-10P |

x3 91-512 (T118A), x3 91-522 (T118B), x1 91-433 (T127DF), x1 91-502 (T118G), x2 91-4PWM (T111HF)

Jigsaw Blade Set for Wood and Plastic - 10 pcs



**91-WOOD-10P**

|    |  |   |             |
|----|--|---|-------------|
|    |  |   |             |
| 10 |  | 1 | 91-WOOD-10P |

x4 91-143 (T144D), x2 91-223 (T101B), x2 91-023 (T111C), x1 91-148 (T244D), x1 91-226 (T101BR)

Jigsaw Blade Set for Wood and Metal - 10 pcs



**91-MIXED-10P**

|    |  |   |              |
|----|--|---|--------------|
|    |  |   |              |
| 10 |  | 1 | 91-MIXED-10P |

x3 91-143 (T144D), x1 91-223 (T101B), x1 91-148 (T244D), x2 91-512 (T118A), x2 91-522 (T118B), x1 91-623 (T111HF)

## MULTI TOOL ACCESSORIES

Multi-Tool Standard Blade for Wood Cutting



### 92-S\_W

|   |                 |    |           |
|---|-----------------|----|-----------|
|   |                 |    |           |
| 1 | 35 x 50 x 97 mm | 70 | 92-133-1P |
| 3 | 35 x 50 x 97 mm | 46 | 92-133-3P |

Multi-Tool Standard Blade for Precision Wood Cutting



### 92-P\_W

|   |                 |    |           |
|---|-----------------|----|-----------|
|   |                 |    |           |
| 1 | 30 x 50 x 97 mm | 70 | 92-205-1P |
| 3 | 30 x 50 x 97 mm | 46 | 92-205-3P |
| 1 | 65 x 50 x 97 mm | 70 | 92-229-1P |

Multi-Tool Curved Standard Blade for Wood Cutting



### 92-C\_W

|   |                 |    |           |
|---|-----------------|----|-----------|
|   |                 |    |           |
| 1 | 65 x 50 x 97 mm | 70 | 92-225-1P |

Multi-Tool Standard Blade for Universal Cutting of Wood with Nails



### 92-U\_WN

|   |                 |    |           |
|---|-----------------|----|-----------|
|   |                 |    |           |
| 1 | 35 x 50 x 97 mm | 70 | 92-160-1P |
| 3 | 35 x 50 x 97 mm | 46 | 92-160-3P |

Multi-Tool Long-Life Standard Blade for Cutting Wood with Nails



### 92-LF\_WN

|   |                 |    |           |
|---|-----------------|----|-----------|
|   |                 |    |           |
| 1 | 50 x 50 x 97 mm | 70 | 92-221-1P |
| 1 | 65 x 50 x 97 mm | 70 | 92-228-1P |

Multi-Tool Standard Blade for Universal Cutting of Wood with Metal



### 92-U\_WM

|   |                  |    |           |
|---|------------------|----|-----------|
|   |                  |    |           |
| 1 | 28 x 55 x 100 mm | 70 | 92-222-1P |
| 3 | 28 x 55 x 100 mm | 46 | 92-222-3P |
| 1 | 44 x 55 x 100 mm | 70 | 92-223-1P |
| 3 | 44 x 55 x 100 mm | 46 | 92-223-3P |

Multi-Tool Carbide Tipped Blade with TiN Coating for Metal Cutting



### 92-C\_M

|   |                 |    |           |
|---|-----------------|----|-----------|
|   |                 |    |           |
| 1 | 35 x 42 x 82 mm | 70 | 92-236-1P |

Multi-Tool Standard Blade for Fine Cutting in Metal



### 92-FM

|   |                 |    |           |
|---|-----------------|----|-----------|
|   |                 |    |           |
| 1 | 30 x 50 x 97 mm | 70 | 92-157-1P |

Multi-Tool Segment Blade for Metal Cutting



### 92-M\_S

|   |       |    |           |
|---|-------|----|-----------|
|   |       |    |           |
| 1 | 85 mm | 90 | 92-106-1P |



Multi-Tool Segment Blade for Wood Cutting



**92-SP**



1 85 mm 90 92-113-1P

Multi-Tool Segment Blade for Slots and Reworking



**92-CG\_S**



1 75 mm 90 92-118-1P

Multi-Tool Standard Knife for Soft Materials



**92-MFK**



1 41 x 42 x 87 mm 70 92-251-1P

Multi-Tool Circular Blade for Metal Cutting



**92-M\_R**



115 85 mm 90 92-174-1P

Multi-Tool Segment Blade for Marble and Epoxy



**92-DG\_S**



1 90 mm 50 92-166-1P

Multi-Tool Standard Scraper Blades



**92-SC**



1 52 x 38 x 83 mm 90 92-165-1P  
1 50 x 38 x 83 mm 90 92-226-1P

Multi-Tool Standard Blade Set for Wood and Metal Cutting - 8 pcs



**92-Universal\_WM\_Set**



8 32 x 160 x 195 mm 34 92-WM-SET-8P

92-222-1Px 2, 92-223-1Px 2

92-228-1Px 2

92-160-1Px 2

Multi-Tool Triangular Blade for Rasping and Reworking



**92-CR\_T**



1 80 mm 90 92-001-1P

Multi-Tool Mushroom Shape Cutting Blade



**92-CM**



1 70 x 30 x 75 mm 90 92-245-1P



## Multi-Tool Triangular Sanding Pads



### 92-Sanding

| 1 | 80 mm | 20 | 92-136-1P      |
|---|-------|----|----------------|
| 5 | 82 mm | 10 | 92-136-G40-5P  |
| 5 | 82 mm | 10 | 92-136-G80-5P  |
| 5 | 82 mm | 10 | 92-136-G120-5P |
| 5 | 82 mm | 10 | 92-136-G240-5P |
| 1 | 93 mm | 50 | 92-137-1P      |
| 5 | 94 mm | 10 | 92-137-G40-5P  |
| 5 | 94 mm | 10 | 92-137-G80-5P  |
| 5 | 94 mm | 10 | 92-137-G120-5P |
| 5 | 94 mm | 10 | 92-137-G240-5P |

## CIRCULAR SAW BLADES

### Circular Saw blades for Cordless Saws in Wood



### 8501-C

| 136 mm | 24 | 1 | 8501-136-10-24C |
|--------|----|---|-----------------|
| 136 mm | 24 | 1 | 8501-136-20-24C |
| 150 mm | 24 | 1 | 8501-150-10-24C |
| 160 mm | 24 | 1 | 8501-160-20-24C |
| 165 mm | 24 | 1 | 8501-165-20-24C |
| 184 mm | 24 | 1 | 8501-184-20-24C |
| 190 mm | 24 | 1 | 8501-190-30-24C |

### Circular Saw blades for Portable-/Table Saws in Wood



### 8501-P/T

| 125 mm | 16 | 1 | 8501-2           |
|--------|----|---|------------------|
| 130 mm | 16 | 1 | 8501-3           |
| 140 mm | 16 | 1 | 8501-4           |
| 140 mm | 24 | 1 | 8501-4F          |
| 140 mm | 30 | 1 | 8501-4XF         |
| 150 mm | 18 | 1 | 8501-5           |
| 150 mm | 30 | 1 | 8501-5F          |
| 160 mm | 18 | 1 | 8501-7           |
| 160 mm | 30 | 1 | 8501-7F          |
| 170 mm | 18 | 1 | 8501-10          |
| 170 mm | 30 | 1 | 8501-10F         |
| 180 mm | 20 | 1 | 8501-12          |
| 180 mm | 40 | 1 | 8501-12F         |
| 184 mm | 24 | 1 | 8501-13          |
| 184 mm | 40 | 1 | 8501-13F         |
| 184 mm | 24 | 1 | 8501-184-16-24   |
| 184 mm | 40 | 1 | 8501-184-16-40   |
| 190 mm | 20 | 1 | 8501-15          |
| 190 mm | 40 | 1 | 8501-15F         |
| 190 mm | 60 | 1 | 8501-190-30-60XF |
| 200 mm | 20 | 1 | 8501-16          |
| 200 mm | 40 | 1 | 8501-16F         |
| 210 mm | 20 | 1 | 8501-17          |
| 210 mm | 40 | 1 | 8501-17F         |
| 210 mm | 60 | 1 | 8501-210-30-60XF |
| 230 mm | 20 | 1 | 8501-22          |
| 230 mm | 40 | 1 | 8501-22F         |
| 230 mm | 60 | 1 | 8501-230-30-60XF |
| 235 mm | 30 | 1 | 8501-23          |
| 235 mm | 40 | 1 | 8501-23F         |
| 235 mm | 60 | 1 | 8501-235-30-60XF |
| 250 mm | 24 | 1 | 8501-28          |
| 250 mm | 40 | 1 | 8501-28F         |
| 250 mm | 60 | 1 | 8501-28XF        |

### Circular Saw blades for Plunge Saws in Wood



### 8501-P

| 160 mm | 48 | 1 | 8501-160-20-48XF |
|--------|----|---|------------------|
| 165 mm | 48 | 1 | 8501-165-20-48XF |

### Circular Saw blades for Mitre Saws in Wood



### 8501-M

| 210 mm | 48 | 1 | 8501-210-30-48SW |
|--------|----|---|------------------|
| 216 mm | 24 | 1 | 8501-16SW        |
| 216 mm | 48 | 1 | 8501-18SW        |
| 216 mm | 60 | 1 | 8501-216-60SW    |
| 250 mm | 60 | 1 | 8501-28SW        |
| 260 mm | 24 | 1 | 8501-260-24SW    |
| 260 mm | 40 | 1 | 8501-260-40SW    |
| 260 mm | 60 | 1 | 8501-260-60SW    |
| 300 mm | 60 | 1 | 8501-30SW        |
| 305 mm | 40 | 1 | 8501-305-30-40SW |
| 305 mm | 60 | 1 | 8501-305-30-60SW |

### Circular Saw blades for Site Saws in Wood



### 8501-S

| 300 mm | 30 | 1 | 8501-30   |
|--------|----|---|-----------|
| 300 mm | 40 | 1 | 8501-30F  |
| 300 mm | 60 | 1 | 8501-30XF |
| 315 mm | 30 | 1 | 8501-31   |
| 315 mm | 40 | 1 | 8501-31F  |
| 400 mm | 40 | 1 | 8501-40   |



Circular Saw blades for Mitre Saws in Aluminium and Plastic



**8501-AP**

| Ø      | Length | Material | Model           |
|--------|--------|----------|-----------------|
| 210 mm | 48     | 1        | 8501-17S        |
| 216 mm | 48     | 1        | 8501-18S        |
| 250 mm | 80     | 1        | 8501-28S        |
| 260 mm | 80     | 1        | 8501-260-30-80S |
| 300 mm | 96     | 1        | 8501-30S        |
| 305 mm | 96     | 1        | 8501-305-30-96S |

**ABRASIVE CUTTING DISCS**

Abrasive High-Performance Cutting Discs for General Purpose Inox & Metal



**391-T41\_IM**

| Ø          | Material | Quantity        | Model |
|------------|----------|-----------------|-------|
| 115x1.6 mm | 50       | 3911-2301922XDT |       |
| 115x1.0 mm | 50       | 3911-2302522XDT |       |
| 125x1.6 mm | 10       | 3911-751010XTM  |       |
| 180x2.0 mm | 50       | 3911-115-T41-IM |       |
| 230x2.5 mm | 50       | 3911-115-T41-IM |       |
| 115x1.0 mm | 50       | 3911-125-T41-IM |       |
| 125x1.0 mm | 50       | 3911-180-T41-IM |       |
| 125x1.0 mm | 50       | 3911-230-T41-IM |       |
| 180x1.6 mm | 25       | 3912-115-T41-IM |       |
| 125x1.0 mm | 25       | 3912-125-T41-IM |       |
| 180x1.6 mm | 25       | 3911-1251T41-IM |       |
| 230x1.9 mm | 50       | 3911-1801T41-IM |       |
| 230x3.0 mm | 50       | 3911-2301T41-IM |       |
| 115x1 mm   | 50       | 3911-2303T41-IM |       |
| 125x1 mm   | 10       | 3911-115-IM-10P |       |
| 125x1 mm   | 10       | 3911-125-IM-10P |       |

Abrasive High-Performance Cutting Discs for Aluminium



**391-T41\_ALU**

| Ø      | Length   | Material | Model           |
|--------|----------|----------|-----------------|
| 115 mm | 22.23 mm | 25       | 3911-115-T41-AL |
| 125 mm | 22.23 mm | 25       | 3911-125-T41-AL |

Abrasive High-Performance Cutting Discs for Inox



**391-T41-I**

| Ø          | Length | Material       | Model |
|------------|--------|----------------|-------|
| 115x1.0 mm | 25     | 3911-115-T41-I |       |
| 125x1.0 mm | 25     | 3911-125-T41-I |       |
| 150x1.0 mm | 50     | 3911-150-T41-I |       |
| 180x1.6 mm | 50     | 3911-180-T41-I |       |
| 230x1.9 mm | 50     | 3911-230-T41-I |       |

Abrasive High-Performance Cutting Discs for Stainless Steel & Metal



**391-T41\_CS**

| Ø      | Length  | Material | Model         |
|--------|---------|----------|---------------|
| 356 mm | 25.4 mm | 35       | 3911-350-X2TM |
| 400 mm | 25.4 mm | 15       | 3911-400-F2TM |
| 400 mm | 25.4 mm | 15       | 3911-400-X2TM |

Abrasive High-Performance Cutting Discs for Metal



**391-T42\_M**

| Ø          | Length | Material       | Model |
|------------|--------|----------------|-------|
| 115x2.5 mm | 25     | 3911-115-T42-M |       |
| 125x2.5 mm | 25     | 3911-125-T42-M |       |
| 150x2.5 mm | 25     | 3911-150-T42-M |       |
| 180x3.2 mm | 25     | 3911-180-T42-M |       |
| 230x3.2 mm | 50     | 3911-230-T42-M |       |

Abrasive High-Performance Cutting Discs for Building & Stone



**391-T42\_ST**

| Ø          | Length | Material        | Model |
|------------|--------|-----------------|-------|
| 115x3.2 mm | 25     | 3912-115-T42-ST |       |
| 125x3.2 mm | 25     | 3912-125-T42-ST |       |
| 180x3.2 mm | 25     | 3912-180-T42-ST |       |
| 230x3.2 mm | 50     | 3912-230-T42-ST |       |

Abrasive High-Performance Grinding Discs for Inox & Metal



**392-T27\_IM**

| Ø          | Length | Material        | Model |
|------------|--------|-----------------|-------|
| 115x6.4 mm | 25     | 3921-115-T27-IM |       |
| 125x6.4 mm | 25     | 3921-125-T27-IM |       |
| 150x6.4 mm | 25     | 3921-150-T27-IM |       |
| 180x6.5 mm | 25     | 3921-180-T27-IM |       |
| 230x6.5 mm | 25     | 3921-230-T27-IM |       |

Abrasive Conical Flap Grinding Discs for  
Inox & Metal



**392-FLAP\_C**

| Ø      | Icons | Quantity | Product Code    |
|--------|-------|----------|-----------------|
| 115 mm |       | 20       | 3926-115IM-C40  |
| 115 mm |       | 20       | 3926-115IM-C60  |
| 115 mm |       | 20       | 3926-115IM-C80  |
| 115 mm |       | 20       | 3926-115IM-C120 |
| 125 mm |       | 20       | 3926-125IM-C40  |
| 125 mm |       | 20       | 3926-125IM-C60  |
| 125 mm |       | 20       | 3926-125IM-C80  |
| 125 mm |       | 20       | 3926-125IM-C120 |

Abrasive Diamond Cutting Discs for  
Ceramic & tiles



**391-DIAM\_C**

| Ø      | Icons | Quantity | Product Code    |
|--------|-------|----------|-----------------|
| 115 mm |       | 100      | 3916-115-10P-CE |
| 125 mm |       | 100      | 3916-125-10P-CE |
| 115 mm |       | 100      | 3917-115-7S-C   |
| 125 mm |       | 100      | 3917-125-7S-C   |

Abrasive Diamond Cutting Discs for  
Reinforced Concrete



**391-DIAM\_RC**

| Ø      | Quantity | Product Code    |
|--------|----------|-----------------|
| 230 mm | 25       | 3916-230-10L-RC |

Abrasive Flap Grinding Discs for Inox &  
Metal



**392-FLAP\_P**

| Ø      | Icons | Quantity | Product Code    |
|--------|-------|----------|-----------------|
| 115 mm |       | 20       | 3927-115IM-P40  |
| 115 mm |       | 20       | 3927-115IM-P60  |
| 115 mm |       | 20       | 3927-115IM-P80  |
| 115 mm |       | 20       | 3927-115IM-P120 |
| 125 mm |       | 20       | 3927-125IM-P40  |
| 125 mm |       | 20       | 3927-125IM-P60  |
| 125 mm |       | 20       | 3927-125IM-P80  |
| 125 mm |       | 20       | 3927-125IM-P120 |
| 125 mm |       | 12       | 3927-125-40-3P  |
| 125 mm |       | 12       | 3927-125-60-3P  |
| 125 mm |       | 12       | 3927-125-80-3P  |
| 125 mm |       | 12       | 3927-125-120-3P |

Abrasive Diamond Cutting Discs for  
General Purpose Stone



**391-DIAM\_U**

| Ø      | Icons | Quantity | Product Code    |
|--------|-------|----------|-----------------|
| 115 mm |       | 100      | 3916-115-10S-UE |
| 125 mm |       | 100      | 3916-125-10S-UE |
| 150 mm |       | 50       | 3916-150-10S-UE |
| 180 mm |       | 50       | 3916-180-10S-UE |
| 230 mm |       | 25       | 3916-230-10S-UE |
| 115 mm |       | 100      | 3917-115-7S-U   |
| 125 mm |       | 100      | 3917-125-7S-U   |
| 230 mm |       | 25       | 3917-230-7S-U   |

Easy-Cut Bandsaw Blades with Portaband



**3857 Easy-Cut Portaband**

| Icons | Icons | Quantity | Product Code            |
|-------|-------|----------|-------------------------|
| S     | EZ    | 1        | 3857-13-0.6-EZ-S-3P690  |
| S     | EZ    | 1        | 3857-13-0.6-EZ-S-3P730  |
| S     | EZ    | 1        | 3857-13-0.6-EZ-S-3P835  |
| S     | EZ    | 1        | 3857-13-0.6-EZ-S-3P900  |
| S     | EZ    | 1        | 3857-13-0.6-EZ-S-3P1140 |
| M     | EZ    | 1        | 3857-13-0.6-EZ-M-3P690  |
| M     | EZ    | 1        | 3857-13-0.6-EZ-M-3P730  |
| M     | EZ    | 1        | 3857-13-0.6-EZ-M-3P835  |
| M     | EZ    | 1        | 3857-13-0.6-EZ-M-3P900  |
| M     | EZ    | 1        | 3857-13-0.6-EZ-M-3P1140 |

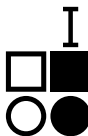



## CARBIDE ROTARY BURRS

### Tungsten Carbide Cylindrical Rotary Burrs for Metal



**A**

| Ø       | Texture | Profile | Item          |
|---------|---------|---------|---------------|
| 3 mm    | Medium  | 1       | A0313M03      |
| 3 mm    | Medium  | 1       | A0313M03E     |
| 3 mm    | Medium  | 1       | A0313M03X     |
| 3 mm    | Medium  | 1       | A0313M03XE    |
| 3 mm    | Medium  | 1       | A0313M03XE-60 |
| 3 mm    | Medium  | 1       | A0313M03XE-80 |
| 6.3 mm  | Medium  | 1       | A0613M03X     |
| 6 mm    | Medium  | 1       | A0616M06      |
| 6 mm    | Medium  | 1       | A0616M06E     |
| 6 mm    | Medium  | 1       | A0616M06X     |
| 6 mm    | Medium  | 1       | A0616M06XE    |
| 8 mm    | Medium  | 1       | A0820M06      |
| 8 mm    | Medium  | 1       | A0820M06E     |
| 8 mm    | Medium  | 1       | A0820M06X     |
| 8 mm    | Medium  | 1       | A0820M06XE    |
| 10 mm   | Medium  | 1       | A1020M06      |
| 10 mm   | Medium  | 1       | A1020M06E     |
| 9.6 mm  | Medium  | 1       | A1020M06X     |
| 9.6 mm  | Medium  | 1       | A1020M06XE    |
| 12 mm   | Medium  | 1       | A1225M06      |
| 12.7 mm | Medium  | 1       | A1225M06E     |
| 12 mm   | Medium  | 1       | A1225M06X     |
| 12.7 mm | Medium  | 1       | A1225M08      |
| 12.7 mm | Medium  | 1       | A1225M08E     |
| 12.7 mm | Medium  | 1       | A1225M08X     |
| 12.7 mm | Medium  | 1       | A1225M08XE    |
| 16 mm   | Medium  | 1       | A1625M06      |
| 16 mm   | Medium  | 1       | A1625M06X     |
| 16 mm   | Medium  | 1       | A1625M06XE    |
| 16 mm   | Medium  | 1       | A1625M08      |
| 16 mm   | Medium  | 1       | A1625M08E     |
| 16 mm   | Medium  | 1       | A1625M08X     |
| 16 mm   | Medium  | 1       | A1625M08XE    |

\* non stock standard

### Tungsten Carbide Cylindrical Round Nose Rotary Burrs for Metal



**C**

| Ø      | Texture | Profile | Item      |
|--------|---------|---------|-----------|
| 3 mm   | Medium  | 1       | C0313M03  |
| 3 mm   | Medium  | 1       | C0313M03X |
| 6.3 mm | Medium  | 1       | C0616M03X |
| 6 mm   | Medium  | 1       | C0616M06  |
| 6 mm   | Medium  | 1       | C0616M06X |
| 8 mm   | Medium  | 1       | C0820M06  |
| 8 mm   | Medium  | 1       | C0820M06X |

| Ø       | Texture | Profile | Item      |
|---------|---------|---------|-----------|
| 9.6 mm  | Medium  | 1       | C1020M06  |
| 10 mm   | Medium  | 1       | C1020M06X |
| 12 mm   | Medium  | 1       | C1225M06  |
| 12 mm   | Medium  | 1       | C1225M06X |
| 12.7 mm | Medium  | 1       | C1225M08X |
| 16 mm   | Medium  | 1       | C1625M06  |
| 16 mm   | Medium  | 1       | C1625M06X |
| 16 mm   | Medium  | 1       | C1625M08  |
| 16 mm   | Medium  | 1       | C1625M08X |

\* non stock standard

### Tungsten Carbide Spherical Rotary Burrs for Metal



**D**

| Ø       | Texture | Profile | Item      |
|---------|---------|---------|-----------|
| 3 mm    | Medium  | 1       | D0303M03  |
| 3 mm    | Medium  | 1       | D0303M03X |
| 6.3 mm  | Medium  | 1       | D0605M03X |
| 6 mm    | Medium  | 1       | D0606M06  |
| 6 mm    | Medium  | 1       | D0606M06X |
| 8 mm    | Medium  | 1       | D0807M06  |
| 8 mm    | Medium  | 1       | D0807M06X |
| 9.6 mm  | Medium  | 1       | D1009M06  |
| 9.6 mm  | Medium  | 1       | D1009M06X |
| 12.7 mm | Medium  | 1       | D1211M06  |
| 12.7 mm | Medium  | 1       | D1211M06X |
| 16 mm   | Medium  | 1       | D1614M06  |
| 16 mm   | Medium  | 1       | D1614M06X |
| 16 mm   | Medium  | 1       | D1614M08  |
| 16 mm   | Medium  | 1       | D1614M08X |

\* non stock standard

### Tungsten Carbide Oval Rotary Burrs for Metal



**E**

| Ø       | Texture | Profile | Item      |
|---------|---------|---------|-----------|
| 3 mm    | Medium  | 1       | E0308M03  |
| 3 mm    | Medium  | 1       | E0308M03X |
| 6 mm    | Medium  | 1       | E0614M06  |
| 8 mm    | Medium  | 1       | E0816M06  |
| 8 mm    | Medium  | 1       | E0816M06X |
| 9.6 mm  | Medium  | 1       | E1018M06  |
| 9.6 mm  | Medium  | 1       | E1018M06X |
| 12.7 mm | Medium  | 1       | E1222M06  |
| 12.7 mm | Medium  | 1       | E1222M06X |
| 12.7 mm | Medium  | 1       | E1222M08  |
| 12.7 mm | Medium  | 1       | E1222M08X |
| 16 mm   | Medium  | 1       | E1625M06  |

| Ø     | Texture | Profile | Item      |
|-------|---------|---------|-----------|
| 16 mm | Medium  | 1       | E1625M06X |
| 16 mm | Medium  | 1       | E1625M08  |
| 16 mm | Medium  | 1       | E1625M08X |

\* non stock standard

### Tungsten Carbide Arch Round Nose Rotary Burrs for Metal



**F**

| Ø       | Texture | Profile | Item      |
|---------|---------|---------|-----------|
| 3 mm    | Medium  | 1       | F0313M03  |
| 3 mm    | Medium  | 1       | F0313M03X |
| 6.3 mm  | Medium  | 1       | F0613M03X |
| 6 mm    | Medium  | 1       | F0618M06  |
| 6 mm    | Medium  | 1       | F0618M06X |
| 8 mm    | Medium  | 1       | F0820M06  |
| 8 mm    | Medium  | 1       | F0820M06X |
| 9.6 mm  | Medium  | 1       | F1020M06  |
| 9.6 mm  | Medium  | 1       | F1020M06X |
| 12.7 mm | Medium  | 1       | F1225M06  |
| 12.7 mm | Medium  | 1       | F1225M06X |
| 12.7 mm | Medium  | 1       | F1225M08  |
| 12.7 mm | Medium  | 1       | F1225M08X |
| 16 mm   | Medium  | 1       | F1625M06  |
| 16 mm   | Medium  | 1       | F1625M06X |
| 16 mm   | Medium  | 1       | F1625M08  |

\* non stock standard

### Tungsten Carbide Arch Pointed Nose Rotary Burrs for Metal



**G**

| Ø       | Texture | Profile | Item      |
|---------|---------|---------|-----------|
| 3 mm    | Medium  | 1       | G0313M03  |
| 3 mm    | Medium  | 1       | G0313M03X |
| 6.3 mm  | Medium  | 1       | G0613M03X |
| 6 mm    | Medium  | 1       | G0618M06  |
| 6 mm    | Medium  | 1       | G0618M06X |
| 8 mm    | Medium  | 1       | G0820M06  |
| 8 mm    | Medium  | 1       | G0820M06X |
| 9.6 mm  | Medium  | 1       | G1020M06  |
| 9.6 mm  | Medium  | 1       | G1020M06X |
| 12.7 mm | Medium  | 1       | G1225M06  |
| 12.7 mm | Medium  | 1       | G1225M06X |
| 12 mm   | Medium  | 1       | G1225M08  |
| 12 mm   | Medium  | 1       | G1225M08X |
| 16 mm   | Medium  | 1       | G1625M06  |
| 16 mm   | Medium  | 1       | G1625M06X |
| 16 mm   | Medium  | 1       | G1625M08  |
| 16 mm   | Medium  | 1       | G1625M08X |

\* non stock standard

Tungsten Carbide Flame Rotary Burrs for Metal



**H**

| 6 mm    | Medium | 1 | H0613M03X |  |
|---------|--------|---|-----------|--|
| 10 mm   | Medium | 1 | H1025M06  |  |
| 10 mm   | Medium | 1 | H1025M06X |  |
| 12.7 mm | Medium | 1 | H1232M06  |  |
| 12.7 mm | Medium | 1 | H1232M06X |  |
| 16 mm   | Medium | 1 | H1635M06X |  |
| 16 mm   | Medium | 1 | H1635M06  |  |
| 16 mm   | Medium | 1 | H1635M08  |  |
| 16 mm   | Medium | 1 | H1635M08X |  |

\* non stock standard

Tungsten Carbide 60° Cone Rotary Burrs for Metal



**J**

| 6 mm    | Medium | 1 | J0604M06 |  |
|---------|--------|---|----------|--|
| 9.6 mm  | Medium | 1 | J1010M06 |  |
| 12.7 mm | Medium | 1 | J1212M06 |  |
| 16 mm   | Medium | 1 | J1616M06 |  |
| 16 mm   | Medium | 1 | J1616M08 |  |

\* non stock standard

Tungsten Carbide 90° Cone Rotary Burrs for Metal



**K**

| 6 mm    | Medium | 1 | K0602M06 |  |
|---------|--------|---|----------|--|
| 9.6 mm  | Medium | 1 | K1008M06 |  |
| 12.7 mm | Medium | 1 | K1210M06 |  |
| 16 mm   | Medium | 1 | K1612M06 |  |
| 16 mm   | Medium | 1 | K1612M08 |  |

\* non stock standard

Tungsten Carbide Conical Round Nose Rotary Burrs for Metal



**L**

| 10 mm   | Medium | 1 | L1020M06  |  |
|---------|--------|---|-----------|--|
| 10 mm   | Medium | 1 | L1020M06X |  |
| 12.7 mm | Medium | 1 | L1225M06  |  |
| 12.7 mm | Medium | 1 | L1225M06X |  |
| 12.7 mm | Medium | 1 | L1230M06  |  |
| 12.7 mm | Medium | 1 | L1230M06X |  |
| 16 mm   | Medium | 1 | L1630M06  |  |
| 16 mm   | Medium | 1 | L1630M06X |  |
| 16 mm   | Medium | 1 | L1630M08  |  |
| 16 mm   | Medium | 1 | L1630M08X |  |

\* non stock standard

Tungsten Carbide Conical Pointed Nose Rotary Burrs for Metal



**M**

| 3 mm    | Medium | 1 | M0310M03  |  |
|---------|--------|---|-----------|--|
| 3 mm    | Medium | 1 | M0310M03X |  |
| 6.3 mm  | Medium | 1 | M0613M03X |  |
| 6 mm    | Medium | 1 | M0618M06  |  |
| 6 mm    | Medium | 1 | M0618M06X |  |
| 9.5 mm  | Medium | 1 | M1022M06  |  |
| 9.5 mm  | Medium | 1 | M1022M06X |  |
| 12.7 mm | Medium | 1 | M1227M06  |  |
| 12.7 mm | Medium | 1 | M1227M06X |  |
| 12.7 mm | Medium | 1 | M1227M08  |  |
| 16 mm   | Medium | 1 | M1630M06  |  |
| 16 mm   | Medium | 1 | M1630M06X |  |
| 16 mm   | Medium | 1 | M1630M08  |  |
| 16 mm   | Medium | 1 | M1630M08X |  |

\* non stock standard

Tungsten Carbide Inverted Cone Nose Rotary Burrs for Metal



**N**

| 3 mm    | Medium | 1 | N0306M03  |  |
|---------|--------|---|-----------|--|
| 3 mm    | Medium | 1 | N0306M03E |  |
| 6 mm    | Medium | 1 | N0607M06  |  |
| 12.7 mm | Medium | 1 | N1213M06  |  |
| 12.7 mm | Medium | 1 | N1213M06X |  |
| 16 mm   | Medium | 1 | N1613M06  |  |
| 16 mm   | Medium | 1 | N1613M06X |  |
| 16 mm   | Medium | 1 | N1613M08  |  |

\* non stock standard

Tungsten Carbide Cylindrical Nose Rotary Burrs for Aluminium



**A-AL**

| 6 mm    | AL | 1 | A0616AL06E  |  |
|---------|----|---|-------------|--|
| 12.7 mm | AL | 1 | A1225AL06E  |  |
| 12.7 mm | AL | 1 | A1225AL08E  |  |
| 16 mm   | AL | 1 | A1625AL08XE |  |

Tungsten Carbide Cylindrical Round Nose Rotary Burrs for Aluminium



**C-AL**

| 6 mm    | AL | 1 | C0616AL06 |  |
|---------|----|---|-----------|--|
| 12.7 mm | AL | 1 | C1225AL06 |  |





Tungsten Carbide Spherical Nose Rotary Burrs for Aluminium



**D-AL**

| Ø       | Material | Qty | Part No.  |
|---------|----------|-----|-----------|
| 12.7 mm | AL       | 1   | D1211AL06 |
| 12.7 mm | AL       | 1   | D1211AL08 |

\* non stock standard

Tungsten Carbide Cylindrical Rotary Special Burrs for Repairing Tyre



**A/G**

| Ø    | Material | Qty | Part No.  |
|------|----------|-----|-----------|
| 6 mm | TR       | 1   | A0625M06X |

\* non stock standard

Tungsten Carbide Spherical Rotary Burrs for High Alloy Steel



**D-S**

| Ø       | Material | Qty | Part No. |
|---------|----------|-----|----------|
| 6 mm    | Steel    | 5   | D0606S06 |
| 9.6 mm  | Steel    | 5   | D1010S06 |
| 12.7 mm | Steel    | 5   | D1212S06 |

Tungsten Carbide Arch Round Nose Rotary Burrs for Aluminium



**F-AL**

| Ø       | Material | Qty | Part No.  |
|---------|----------|-----|-----------|
| 6 mm    | AL       | 1   | F0618AL06 |
| 12.7 mm | AL       | 1   | F1225AL06 |
| 12.7 mm | AL       | 1   | F1225AL08 |

Tungsten Carbide Cylindrical Rotary Burrs for High Alloy Steel



**A-S**

| Ø       | Material | Qty | Part No.  |
|---------|----------|-----|-----------|
| 6 mm    | Steel    | 5   | A0618S06E |
| 9.6 mm  | Steel    | 5   | A1020S06  |
| 9.6 mm  | Steel    | 5   | A1020S06E |
| 12.7 mm | Steel    | 5   | A1225S06  |
| 12.7 mm | Steel    | 5   | A1225S06E |

Tungsten Carbide Arch Round Nose Rotary Burrs for High Alloy Steel



**F-S**

| Ø       | Material | Qty | Part No. |
|---------|----------|-----|----------|
| 6 mm    | Steel    | 5   | F0618S06 |
| 9.6 mm  | Steel    | 5   | F1020S06 |
| 12.7 mm | Steel    | 5   | F1225S06 |

Tungsten Carbide Conical Round Nose Rotary Burrs for Aluminium



**L-AL**

| Ø       | Material | Qty | Part No.  |
|---------|----------|-----|-----------|
| 12.7 mm | AL       | 1   | L1230AL06 |
| 12.7 mm | AL       | 1   | L1230AL08 |

\* non stock standard

Tungsten Carbide Cylindrical Round Nose Rotary Burrs for High Alloy Steel



**C-S**

| Ø       | Material | Qty | Part No. |
|---------|----------|-----|----------|
| 6 mm    | Steel    | 5   | C0618S06 |
| 9.6 mm  | Steel    | 5   | C1020S06 |
| 12.7 mm | Steel    | 5   | C1225S06 |

Tungsten Carbide Arch Pointed Nose Rotary Burrs for High Alloy Steel



**G-S**

| Ø       | Material | Qty | Part No. |
|---------|----------|-----|----------|
| 9.6 mm  | Steel    | 5   | G1020S06 |
| 12.7 mm | Steel    | 5   | G1225S06 |

Tungsten Carbide Conical Round Nose Rotary Burrs for High Alloy Steel



**L-S**

| Ø       | Material | Qty | Part No. |
|---------|----------|-----|----------|
| 9.6 mm  | Steel    | 5   | L1020S06 |
| 12.7 mm | Steel    | 5   | L1228S06 |

Tungsten Carbide Spherical Rotary Burrs for Stainless Steel



**D-I**

| Ø       | Material | Qty | Part No. |
|---------|----------|-----|----------|
| 3 mm    | Inox     | 5   | D0303I03 |
| 6 mm    | Inox     | 5   | D0606I06 |
| 9.6 mm  | Inox     | 5   | D1010I06 |
| 12.7 mm | Inox     | 5   | D1212I06 |

Tungsten Carbide Arch Pointed Nose Rotary Burrs for Stainless Steel



**G-I**

| Ø       | Material | Qty | Part No. |
|---------|----------|-----|----------|
| 9.6 mm  | Inox     | 5   | G1020I06 |
| 12.7 mm | Inox     | 5   | G1225I06 |

Tungsten Carbide Cylindrical Rotary Burrs for Stainless Steel



**A-I**

| Ø       | Material | Qty | Part No. |
|---------|----------|-----|----------|
| 3 mm    | Inox     | 5   | A0314I03 |
| 6 mm    | Inox     | 5   | A0618I06 |
| 9.6 mm  | Inox     | 5   | A1020I06 |
| 12.7 mm | Inox     | 5   | A1225I06 |

Tungsten Carbide Oval Rotary Burrs for Stainless Steel



**E-I**

| Ø       | Material | Qty | Part No. |
|---------|----------|-----|----------|
| 9.6 mm  | Inox     | 5   | E1015I06 |
| 12.7 mm | Inox     | 5   | E1220I06 |

Tungsten Carbide Flame Rotary Burrs for Stainless Steel



**H-I**

| Ø       | Material | Qty | Part No. |
|---------|----------|-----|----------|
| 9.6 mm  | Inox     | 5   | H1020I06 |
| 12.7 mm | Inox     | 5   | H1232I06 |

Tungsten Carbide Cylindrical Round Nose Rotary Burrs for Stainless Steel



**C-I**

| Ø       | Material | Qty | Part No. |
|---------|----------|-----|----------|
| 3 mm    | Inox     | 5   | C0312I03 |
| 6 mm    | Inox     | 5   | C0618I06 |
| 9.6 mm  | Inox     | 5   | C1020I06 |
| 12.7 mm | Inox     | 5   | C1225I06 |

Tungsten Carbide Arch Round Nose Rotary Burrs for Stainless Steel



**F-I**

| Ø       | Material | Qty | Part No. |
|---------|----------|-----|----------|
| 3 mm    | Inox     | 5   | F0312I03 |
| 6 mm    | Inox     | 5   | F0618I06 |
| 9.6 mm  | Inox     | 5   | F1020I06 |
| 12.7 mm | Inox     | 5   | F1225I06 |

Tungsten Carbide Conical Round Nose Rotary Burrs for Stainless Steel



**L-I**

| Ø       | Material | Qty | Part No. |
|---------|----------|-----|----------|
| 9.6 mm  | Inox     | 5   | L1020I06 |
| 12.7 mm | Inox     | 5   | L1228I06 |



Tungsten Carbide Arch Pointed Nose Rotary Burrs for Tire Repair



TR

| Size   | Application | Qty | Part No.       |
|--------|-------------|-----|----------------|
| 3 mm   | Tire Repair | 5   | TR0325M03X-50  |
| 4.5 mm | Tire Repair | 5   | TR0636M06X-65  |
| 6 mm   | Tire Repair | 5   | TR0650M06X-80  |
| 8 mm   | Tire Repair | 5   | TR0860M08X-110 |
| 8 mm   | Tire Repair | 5   | TR4.530M06X-90 |

Tungsten Carbide Rotary Burrs Set for Metal 10 and 12 mm - 5 Pcs



ST-1-5P

| Qty | Weight (g) | Part No.          |
|-----|------------|-------------------|
| 5   | 376 g      | 1 RB-SET1-M06X-5P |

|            |  |
|------------|--|
| A1020M06XE |  |
| C1225M06X  |  |
| F1225M06X  |  |
| G1020M06X  |  |
| L1230M06X  |  |

Tungsten Carbide Rotary Burrs Set for Metal 10 mm - 5 Pcs



ST-2-5P

| Qty | Weight (g) | Part No.          |
|-----|------------|-------------------|
| 5   | 313 g      | 1 RB-SET2-M06X-5P |

**BAHCO**

|            |  |
|------------|--|
| A1020M06XE |  |
| C1020M06X  |  |
| D1009M06X  |  |
| F1020M06X  |  |
| L1020M06X  |  |

Tungsten Carbide Rotary Burrs Set for Metal - 10 Pcs



ST-10P

| Qty | Weight (g) | Part No.          |
|-----|------------|-------------------|
| 10  | 542 g      | 1 RB-SET-M06X-10P |

|                       |  |
|-----------------------|--|
| A1020M06XE, A1225M06X |  |
| C1020M06X, C1225M06X  |  |
| D1211M06X             |  |
| E1018M06X             |  |
| F1225M06X             |  |
| G1020M06X, G1225M06X  |  |
| L1230M06X             |  |

Tungsten Carbide Rotary Burrs Set for Aluminium - 5 pcs



ALU-5P

| Qty | Weight (g) | Part No.         |
|-----|------------|------------------|
| 5   | 380 g      | 1 RB-SET-AL06-5P |

|            |  |
|------------|--|
| A1225AL06E |  |
| C1225AL06  |  |
| D1211AL06  |  |
| F1225AL06  |  |
| L1230AL06  |  |

DRILL BITS

SDS Max Drill Bits 4-cutter for Reinforced Concrete



4656

| Size    | Length (mm) | Qty | Part No.     |
|---------|-------------|-----|--------------|
| 12.0 mm | 340 mm      | 1   | 4656-12-340  |
| 12.0 mm | 540 mm      | 1   | 4656-12-540  |
| 14.0 mm | 340 mm      | 1   | 4656-14-340  |
| 14.0 mm | 540 mm      | 1   | 4656-14-540  |
| 15.0 mm | 340 mm      | 1   | 4656-15-340  |
| 16.0 mm | 340 mm      | 1   | 4656-16-340  |
| 16.0 mm | 540 mm      | 1   | 4656-16-540  |
| 16.0 mm | 940 mm      | 1   | 4656-16-940  |
| 16.0 mm | 1320 mm     | 1   | 4656-16-1320 |
| 18.0 mm | 340 mm      | 1   | 4656-18-340  |
| 18.0 mm | 540 mm      | 1   | 4656-18-540  |
| 18.0 mm | 940 mm      | 1   | 4656-18-940  |
| 18.0 mm | 1320 mm     | 1   | 4656-18-1320 |
| 20.0 mm | 320 mm      | 1   | 4656-20-320  |
| 20.0 mm | 520 mm      | 1   | 4656-20-520  |
| 20.0 mm | 920 mm      | 1   | 4656-20-920  |
| 20.0 mm | 1320 mm     | 1   | 4656-20-1320 |
| 22.0 mm | 320 mm      | 1   | 4656-22-320  |
| 22.0 mm | 520 mm      | 1   | 4656-22-520  |
| 22.0 mm | 920 mm      | 1   | 4656-22-920  |
| 22.0 mm | 1320 mm     | 1   | 4656-22-1320 |
| 24.0 mm | 320 mm      | 1   | 4656-24-320  |
| 24.0 mm | 520 mm      | 1   | 4656-24-520  |
| 25.0 mm | 320 mm      | 1   | 4656-25-320  |
| 25.0 mm | 520 mm      | 1   | 4656-25-520  |
| 25.0 mm | 920 mm      | 1   | 4656-25-920  |
| 25.0 mm | 1320 mm     | 1   | 4656-25-1320 |
| 26.0 mm | 520 mm      | 1   | 4656-26-520  |
| 28.0 mm | 370 mm      | 1   | 4656-28-370  |
| 28.0 mm | 570 mm      | 1   | 4656-28-570  |
| 28.0 mm | 670 mm      | 1   | 4656-28-670  |
| 28.0 mm | 920 mm      | 1   | 4656-28-920  |
| 30.0 mm | 370 mm      | 1   | 4656-30-370  |
| 30.0 mm | 570 mm      | 1   | 4656-30-570  |
| 32.0 mm | 370 mm      | 1   | 4656-32-370  |
| 32.0 mm | 570 mm      | 1   | 4656-32-570  |
| 32.0 mm | 920 mm      | 1   | 4656-32-920  |
| 32.0 mm | 1320 mm     | 1   | 4656-32-1320 |
| 35.0 mm | 370 mm      | 1   | 4656-35-370  |
| 35.0 mm | 570 mm      | 1   | 4656-35-570  |
| 35.0 mm | 670 mm      | 1   | 4656-35-670  |
| 37.0 mm | 370 mm      | 1   | 4656-37-370  |
| 37.0 mm | 570 mm      | 1   | 4656-37-570  |
| 37.0 mm | 920 mm      | 1   | 4656-37-920  |
| 38.0 mm | 370 mm      | 1   | 4656-38-370  |
| 38.0 mm | 570 mm      | 1   | 4656-38-570  |
| 40.0 mm | 370 mm      | 1   | 4656-40-370  |
| 40.0 mm | 570 mm      | 1   | 4656-40-570  |
| 40.0 mm | 920 mm      | 1   | 4656-40-920  |
| 40.0 mm | 1320 mm     | 1   | 4656-40-1320 |
| 45.0 mm | 570 mm      | 1   | 4656-45-570  |
| 45.0 mm | 920 mm      | 1   | 4656-45-920  |
| 50.0 mm | 570 mm      | 1   | 4656-50-570  |
| 52.0 mm | 570 mm      | 1   | 4656-52-570  |

SDS+ Drill Bits 4-cutter for Reinforced Concrete



4651



| Ø       | L       |    |                  |
|---------|---------|----|------------------|
| 5.0 mm  | 115 mm  | 1  | 4651-5-110       |
| 5.0 mm  | 110 mm  | 1  | 4651-5-110-10P   |
| 5.0 mm  | 165 mm  | 1  | 4651-5-160       |
| 5.0 mm  | 160 mm  | 1  | 4651-5-160-10P   |
| 5.0 mm  | 265 mm  | 1  | 4651-5-260       |
| 5.5 mm  | 110 mm  | 10 | 4651-5,5-110-10P |
| 5.5 mm  | 160 mm  | 1  | 4651-5,5-160-10P |
| 5.5 mm  | 115 mm  | 1  | 4651-5,5-110     |
| 5.5 mm  | 165 mm  | 1  | 4651-5,5-160     |
| 6.0 mm  | 115 mm  | 1  | 4651-6-110       |
| 6.0 mm  | 110 mm  | 1  | 4651-6-110-10P   |
| 6.0 mm  | 165 mm  | 1  | 4651-6-160       |
| 6.0 mm  | 160 mm  | 1  | 4651-6-160-10P   |
| 6.0 mm  | 215 mm  | 1  | 4651-6-210       |
| 6.0 mm  | 265 mm  | 1  | 4651-6-260       |
| 6.0 mm  | 315 mm  | 1  | 4651-6-310       |
| 6.5 mm  | 110 mm  | 50 | 4651-6,5-110     |
| 6.5 mm  | 165 mm  | 1  | 4651-6,5-160     |
| 6.5 mm  | 160 mm  | 1  | 4651-6,5-160-10P |
| 6.5 mm  | 215 mm  | 1  | 4651-6,5-210     |
| 6.5 mm  | 265 mm  | 1  | 4651-6,5-260     |
| 6.5 mm  | 315 mm  | 1  | 4651-6,5-310     |
| 7.0 mm  | 115 mm  | 1  | 4651-7-110       |
| 7.0 mm  | 165 mm  | 1  | 4651-7-160       |
| 8.0 mm  | 115 mm  | 1  | 4651-8-110       |
| 8.0 mm  | 165 mm  | 1  | 4651-8-160       |
| 8.0 mm  | 160 mm  | 1  | 4651-8-160-10P   |
| 8.0 mm  | 215 mm  | 1  | 4651-8-210       |
| 8.0 mm  | 210 mm  | 1  | 4651-8-210-10P   |
| 8.0 mm  | 265 mm  | 1  | 4651-8-260       |
| 8.0 mm  | 315 mm  | 1  | 4651-8-310       |
| 8.0 mm  | 465 mm  | 1  | 4651-8-460       |
| 10.0 mm | 115 mm  | 1  | 4651-10-110      |
| 10.0 mm | 165 mm  | 1  | 4651-10-160      |
| 10.0 mm | 160 mm  | 1  | 4651-10-160-10P  |
| 10.0 mm | 215 mm  | 1  | 4651-10-210      |
| 10.0 mm | 210 mm  | 1  | 4651-10-210-10P  |
| 10.0 mm | 265 mm  | 1  | 4651-10-260      |
| 10.0 mm | 315 mm  | 1  | 4651-10-310      |
| 10.0 mm | 455 mm  | 1  | 4651-10-450      |
| 10.0 mm | 600 mm  | 1  | 4651-10-600      |
| 10.0 mm | 1000 mm | 1  | 4651-10-1000     |
| 12.0 mm | 160 mm  | 1  | 4651-12-160      |
| 12.0 mm | 160 mm  | 1  | 4651-12-160-10P  |
| 12.0 mm | 210 mm  | 1  | 4651-12-210      |
| 12.0 mm | 210 mm  | 1  | 4651-12-210-10P  |
| 12.0 mm | 260 mm  | 1  | 4651-12-260      |
| 12.0 mm | 310 mm  | 1  | 4651-12-310      |
| 12.0 mm | 450 mm  | 1  | 4651-12-450      |
| 12.0 mm | 600 mm  | 1  | 4651-12-600      |
| 12.0 mm | 1000 mm | 1  | 4651-12-1000     |
| 14.0 mm | 160 mm  | 1  | 4651-14-160      |
| 14.0 mm | 210 mm  | 1  | 4651-14-210      |
| 14.0 mm | 260 mm  | 1  | 4651-14-260      |
| 14.0 mm | 310 mm  | 1  | 4651-14-310      |
| 14.0 mm | 450 mm  | 1  | 4651-14-450      |
| 14.0 mm | 600 mm  | 1  | 4651-14-600      |
| 14.0 mm | 1000 mm | 1  | 4651-14-1000     |
| 15.0 mm | 160 mm  | 1  | 4651-15-160      |
| 15.0 mm | 260 mm  | 1  | 4651-15-260      |
| 15.0 mm | 450 mm  | 1  | 4651-15-450      |
| 16.0 mm | 160 mm  | 1  | 4651-16-160      |
| 16.0 mm | 210 mm  | 1  | 4651-16-210      |
| 16.0 mm | 260 mm  | 1  | 4651-16-260      |
| 16.0 mm | 310 mm  | 1  | 4651-16-310      |
| 16.0 mm | 450 mm  | 1  | 4651-16-450      |
| 16.0 mm | 600 mm  | 1  | 4651-16-600      |

| Ø       | L       |   |              |
|---------|---------|---|--------------|
| 16.0 mm | 1000 mm | 1 | 4651-16-1000 |
| 18.0 mm | 250 mm  | 1 | 4651-18-250  |
| 18.0 mm | 450 mm  | 1 | 4651-18-450  |
| 20.0 mm | 250 mm  | 1 | 4651-20-250  |
| 20.0 mm | 450 mm  | 1 | 4651-20-450  |
| 22.0 mm | 250 mm  | 1 | 4651-22-250  |
| 22.0 mm | 450 mm  | 1 | 4651-22-450  |
| 24.0 mm | 250 mm  | 1 | 4651-24-250  |
| 24.0 mm | 450 mm  | 1 | 4651-24-450  |
| 25.0 mm | 250 mm  | 1 | 4651-25-250  |
| 25.0 mm | 450 mm  | 1 | 4651-25-450  |
| 28.0 mm | 250 mm  | 1 | 4651-28-250  |
| 28.0 mm | 450 mm  | 1 | 4651-28-450  |
| 30.0 mm | 250 mm  | 1 | 4651-30-250  |
| 30.0 mm | 450 mm  | 1 | 4651-30-450  |
| 32.0 mm | 450 mm  | 1 | 4651-32-450  |

Drill Set for Reinforced Concrete SDS + 4C - 5 pcs



4651-SET-5

| X |   |            |
|---|---|------------|
| 5 | 1 | 4651-SET-5 |

4651-5-110, 4651-6-110, 4651-6-160, 4651-8-160, 4651-10-160

Drill Set for Reinforced Concrete SDS + 4C - 7 pcs



4651-SET-7

| X |   |            |
|---|---|------------|
| 7 | 1 | 4651-SET-7 |

4651-5-110, 4651-6-110, 4651-8-110, 4651-6-160, 4651-8-160, 4651-10-160, 4651-12-160

SDS+ Drill Bits 2-cutter for Concrete



4652



| Ø       | L      |    |                  |
|---------|--------|----|------------------|
| 3.0 mm  | 110 mm | 50 | 4652-3-110       |
| 3.5 mm  | 110 mm | 50 | 4652-3,5-110     |
| 4.0 mm  | 110 mm | 1  | 4652-4-110       |
| 4.0 mm  | 160 mm | 1  | 4652-4-160       |
| 5.0 mm  | 110 mm | 1  | 4652-5-110       |
| 5.0 mm  | 160 mm | 1  | 4652-5-160       |
| 5.0 mm  | 110 mm | 1  | 4652-5-110-10P   |
| 5.0 mm  | 160 mm | 1  | 4652-5-160-10P   |
| 5.0 mm  | 210 mm | 1  | 4652-5-210       |
| 5.5 mm  | 110 mm | 1  | 4652-5,5-110     |
| 5.5 mm  | 110 mm | 10 | 4652-5,5-110-10P |
| 5.5 mm  | 160 mm | 1  | 4652-5,5-160     |
| 5.5 mm  | 160 mm | 1  | 4652-5,5-160-10P |
| 5.5 mm  | 210 mm | 50 | 4652-5,5-210     |
| 6.0 mm  | 110 mm | 1  | 4652-6-110       |
| 6.0 mm  | 110 mm | 1  | 4652-6-110-10P   |
| 6.0 mm  | 160 mm | 50 | 4652-6-160       |
| 6.0 mm  | 160 mm | 1  | 4652-6-160-10P   |
| 6.0 mm  | 210 mm | 1  | 4652-6-210       |
| 6.0 mm  | 260 mm | 1  | 4652-6-260       |
| 6.5 mm  | 110 mm | 1  | 4652-6,5-110     |
| 6.5 mm  | 160 mm | 1  | 4652-6,5-160     |
| 6.5 mm  | 160 mm | 1  | 4652-6,5-160-10P |
| 7.0 mm  | 110 mm | 1  | 4652-7-110       |
| 7.0 mm  | 160 mm | 1  | 4652-7-160       |
| 8.0 mm  | 110 mm | 1  | 4652-8-110       |
| 8.0 mm  | 160 mm | 1  | 4652-8-160       |
| 8.0 mm  | 160 mm | 1  | 4652-8-160-10P   |
| 8.0 mm  | 210 mm | 1  | 4652-8-210       |
| 8.0 mm  | 210 mm | 1  | 4652-8-210-10P   |
| 8.0 mm  | 260 mm | 1  | 4652-8-260       |
| 8.0 mm  | 460 mm | 1  | 4652-8-460       |
| 9.0 mm  | 160 mm | 1  | 4652-9-160       |
| 9.0 mm  | 210 mm | 1  | 4652-9-210       |
| 10.0 mm | 110 mm | 1  | 4652-10-110      |
| 10.0 mm | 160 mm | 1  | 4652-10-160      |
| 10.0 mm | 160 mm | 1  | 4652-10-160-10P  |
| 10.0 mm | 210 mm | 1  | 4652-10-210      |
| 10.0 mm | 210 mm | 1  | 4652-10-210-10P  |
| 10.0 mm | 260 mm | 1  | 4652-10-260      |
| 10.0 mm | 310 mm | 1  | 4652-10-310      |
| 10.0 mm | 450 mm | 1  | 4652-10-450      |
| 10.0 mm | 600 mm | 1  | 4652-10-600      |
| 11.0 mm | 160 mm | 1  | 4652-11-160      |
| 11.0 mm | 260 mm | 1  | 4652-11-260      |
| 12.0 mm | 160 mm | 1  | 4652-12-160      |
| 12.0 mm | 160 mm | 1  | 4652-12-160-10P  |
| 12.0 mm | 210 mm | 1  | 4652-12-210      |
| 12.0 mm | 210 mm | 1  | 4652-12-210-10P  |
| 12.0 mm | 260 mm | 1  | 4652-12-260      |
| 12.0 mm | 310 mm | 1  | 4652-12-310      |



| Ø       | L       |   |              |
|---------|---------|---|--------------|
| 12.0 mm | 450 mm  | 1 | 4652-12-450  |
| 12.0 mm | 600 mm  | 1 | 4652-12-600  |
| 12.0 mm | 1000 mm | 1 | 4652-12-1000 |
| 13.0 mm | 310 mm  | 1 | 4652-13-310  |
| 14.0 mm | 160 mm  | 1 | 4652-14-160  |
| 14.0 mm | 210 mm  | 1 | 4652-14-210  |
| 14.0 mm | 260 mm  | 1 | 4652-14-260  |
| 14.0 mm | 310 mm  | 1 | 4652-14-310  |
| 14.0 mm | 450 mm  | 1 | 4652-14-450  |
| 14.0 mm | 600 mm  | 1 | 4652-14-600  |
| 14.0 mm | 1000 mm | 1 | 4652-14-1000 |
| 15.0 mm | 260 mm  | 1 | 4652-15-260  |
| 16.0 mm | 210 mm  | 1 | 4652-16-210  |
| 16.0 mm | 260 mm  | 1 | 4652-16-260  |
| 16.0 mm | 310 mm  | 1 | 4652-16-310  |
| 16.0 mm | 450 mm  | 1 | 4652-16-450  |
| 16.0 mm | 600 mm  | 1 | 4652-16-600  |
| 16.0 mm | 1000 mm | 1 | 4652-16-1000 |
| 18.0 mm | 200 mm  | 1 | 4652-18-200  |
| 18.0 mm | 300 mm  | 1 | 4652-18-300  |
| 18.0 mm | 450 mm  | 1 | 4652-18-450  |
| 18.0 mm | 1000 mm | 1 | 4652-18-1000 |
| 20.0 mm | 200 mm  | 1 | 4652-20-200  |
| 20.0 mm | 300 mm  | 1 | 4652-20-300  |
| 20.0 mm | 450 mm  | 1 | 4652-20-450  |
| 20.0 mm | 600 mm  | 1 | 4652-20-600  |
| 20.0 mm | 1000 mm | 1 | 4652-20-1000 |
| 22.0 mm | 250 mm  | 1 | 4652-22-250  |
| 22.0 mm | 450 mm  | 1 | 4652-22-450  |
| 22.0 mm | 600 mm  | 1 | 4652-22-600  |
| 22.0 mm | 1000 mm | 1 | 4652-22-1000 |
| 24.0 mm | 250 mm  | 1 | 4652-24-250  |
| 24.0 mm | 450 mm  | 1 | 4652-24-450  |
| 25.0 mm | 250 mm  | 1 | 4652-25-250  |
| 25.0 mm | 450 mm  | 1 | 4652-25-450  |
| 25.0 mm | 1000 mm | 1 | 4652-25-1000 |
| 26.0 mm | 250 mm  | 1 | 4652-26-250  |
| 26.0 mm | 450 mm  | 1 | 4652-26-450  |

### Drill Set for Reinforced Concrete SDS + 2C - 7 pcs



#### 4652-SET-7



7

1 4652-SET-7

4652-5-110, 4652-6-110, 4652-8-110,  
4652-6-160, 4652-8-160, 4652-10-160,  
4652-12-160



### Drill Bits for Concrete with Carbide Tip



#### 4641

| Ø       | L      |   |              |
|---------|--------|---|--------------|
| 3.0 mm  | 60 mm  | 1 | 4641-3-60    |
| 4.0 mm  | 75 mm  | 1 | 4641-4-75    |
| 5.0 mm  | 85 mm  | 1 | 4641-5-85    |
| 5.0 mm  | 150 mm | 1 | 4641-5-150   |
| 5.5 mm  | 85 mm  | 1 | 4641-5.5-85  |
| 6.0 mm  | 100 mm | 1 | 4641-6-100   |
| 6.0 mm  | 150 mm | 1 | 4641-6-150   |
| 6.0 mm  | 400 mm | 1 | 4641-6-400   |
| 6.5 mm  | 100 mm | 1 | 4641-6.5-100 |
| 7.0 mm  | 100 mm | 1 | 4641-7-100   |
| 8.0 mm  | 120 mm | 1 | 4641-8-120   |
| 8.0 mm  | 200 mm | 1 | 4641-8-200   |
| 8.0 mm  | 400 mm | 1 | 4641-8-400   |
| 9.0 mm  | 120 mm | 1 | 4641-9-120   |
| 10.0 mm | 120 mm | 1 | 4641-10-120  |
| 10.0 mm | 200 mm | 1 | 4641-10-200  |
| 10.0 mm | 400 mm | 1 | 4641-10-400  |
| 10.0 mm | 600 mm | 1 | 4641-10-600  |
| 11.0 mm | 150 mm | 1 | 4641-11-150  |
| 12.0 mm | 150 mm | 1 | 4641-12-150  |
| 12.0 mm | 200 mm | 1 | 4641-12-200  |
| 12.0 mm | 400 mm | 1 | 4641-12-400  |
| 12.0 mm | 600 mm | 1 | 4641-12-600  |
| 13.0 mm | 150 mm | 1 | 4641-13-150  |
| 14.0 mm | 150 mm | 1 | 4641-14-150  |
| 14.0 mm | 400 mm | 1 | 4641-14-400  |
| 14.0 mm | 600 mm | 1 | 4641-14-600  |
| 16.0 mm | 150 mm | 1 | 4641-16-150  |
| 16.0 mm | 400 mm | 1 | 4641-16-400  |

### Drill Set for Reinforced Concrete SDS + 2C - 5 pcs



#### 4652-SET-5



5

1 4652-SET-5

4652-5-110, 4652-6-110, 4652-6-160,  
4652-8-160, 4652-10-160



| Ø       | L      |   |             |
|---------|--------|---|-------------|
| 16.0 mm | 600 mm | 1 | 4641-16-600 |
| 18.0 mm | 400 mm | 1 | 4641-18-400 |
| 18.0 mm | 600 mm | 1 | 4641-18-600 |
| 20.0 mm | 400 mm | 1 | 4641-20-400 |
| 20.0 mm | 600 mm | 1 | 4641-20-600 |
| 22.0 mm | 400 mm | 1 | 4641-22-400 |
| 24.0 mm | 400 mm | 1 | 4641-24-400 |
| 25.0 mm | 400 mm | 1 | 4641-25-400 |

### Drill Set for Concrete with Carbide Tip - 5 Pcs



#### 4641-PB



5

185 g

1 4641-PB

4641-4-75, 4641-5-85, 4641-6-100, 4641-8-120,  
4641-10-120

### Drill Set for Masonry with Carbide Tip - 5 pcs



#### 4643-PB



5

150 g

1 4643-PB

4mm, 5mm, 6mm, 8mm and 10mm



SDS Max Chisel Drill Bits for Reinforced Concrete



4659



| Ø       | L      |   |                |
|---------|--------|---|----------------|
| - mm    | 280 mm | 1 | 4659-POINT-28  |
| - mm    | 400 mm | 1 | 4659-POINT-40  |
| - mm    | 600 mm | 1 | 4659-POINT-60  |
| 24.0 mm | 280 mm | 1 | 4659-FLAT-28   |
| 24.0 mm | 400 mm | 1 | 4659-FLAT-40   |
| 24.0 mm | 600 mm | 1 | 4659-FLAT-60   |
| 80.0 mm | 300 mm | 1 | 4659-WIDE-30-8 |
| 50.0 mm | 360 mm | 1 | 4659-WIDE-36-5 |
| 50.0 mm | 300 mm | 1 | 4659-TILE-30-5 |
| 80.0 mm | 300 mm | 1 | 4659-TILE-30-8 |

SDS+ Chisel Drill Bits for Reinforced Concrete



4655



| Ø       | L      |   |                 |
|---------|--------|---|-----------------|
| 20.0 mm | 250 mm | 1 | 4655-FLAT-250   |
| 22.0 mm | 240 mm | 1 | 4655-HOLLOW-240 |
| - mm    | 250 mm | 1 | 4655-POINT-250  |
| 32.0 mm | 200 mm | 1 | 4655-SLOT-25032 |
| 38.0 mm | 200 mm | 1 | 4655-TILE-20040 |
| 38.0 mm | 200 mm | 1 | 4655-WIDE-20040 |
| 22.0 mm | 250 mm | 1 | 4655-WING-C-250 |

Cobalt HSS-E Drill Bits for Metal



4411



| Ø       | L      |   |           |
|---------|--------|---|-----------|
| 1.00 mm | 34 mm  | 1 | 4411-1.00 |
| 1.50 mm | 40 mm  | 1 | 4411-1.50 |
| 2.00 mm | 49 mm  | 1 | 4411-2.00 |
| 2.50 mm | 57 mm  | 1 | 4411-2.50 |
| 3.00 mm | 61 mm  | 1 | 4411-3.00 |
| 3.25 mm | 65 mm  | 1 | 4411-3.25 |
| 3.30 mm | 65 mm  | 1 | 4411-3.30 |
| 3.50 mm | 70 mm  | 1 | 4411-3.50 |
| 4.00 mm | 75 mm  | 1 | 4411-4.00 |
| 4.20 mm | 75 mm  | 1 | 4411-4.20 |
| 4.25 mm | 75 mm  | 1 | 4411-4.25 |
| 4.50 mm | 80 mm  | 1 | 4411-4.50 |
| 5.00 mm | 86 mm  | 1 | 4411-5.00 |
| 5.50 mm | 93 mm  | 1 | 4411-5.50 |
| 6.00 mm | 93 mm  | 1 | 4411-6.00 |
| 6.50 mm | 101 mm | 1 | 4411-6.50 |
| 6.80 mm | 109 mm | 1 | 4411-6.80 |

| Ø        | L      |   |            |
|----------|--------|---|------------|
| 7.00 mm  | 109 mm | 1 | 4411-7.00  |
| 7.50 mm  | 109 mm | 1 | 4411-7.50  |
| 8.00 mm  | 117 mm | 1 | 4411-8.00  |
| 8.50 mm  | 117 mm | 1 | 4411-8.50  |
| 9.00 mm  | 125 mm | 1 | 4411-9.00  |
| 9.50 mm  | 125 mm | 1 | 4411-9.50  |
| 10.00 mm | 125 mm | 1 | 4411-10.00 |
| 10.20 mm | 133 mm | 1 | 4411-10.20 |
| 10.50 mm | 133 mm | 1 | 4411-10.50 |
| 11.00 mm | 142 mm | 1 | 4411-11.00 |
| 11.50 mm | 142 mm | 1 | 4411-11.50 |
| 12.00 mm | 151 mm | 1 | 4411-12.00 |
| 12.50 mm | 151 mm | 1 | 4411-12.50 |
| 13.00 mm | 151 mm | 1 | 4411-13.00 |

Size 1 mm up to 4 mm, two drills in each tube

Cobalt HSS-E Drill Bits for Metal with Industrial Pack



4511

| Ø        | L      |   |               |
|----------|--------|---|---------------|
| 0.50 mm  | 22 mm  | 1 | 4511-0.50-10P |
| 0.75 mm  | 28 mm  | 1 | 4511-0.75-10P |
| 1.00 mm  | 34 mm  | 1 | 4511-1.00-10P |
| 1.50 mm  | 40 mm  | 1 | 4511-1.50-10P |
| 1.75 mm  | 46 mm  | 1 | 4511-1.75-10P |
| 2.00 mm  | 49 mm  | 1 | 4511-2.00-10P |
| 2.50 mm  | 57 mm  | 1 | 4511-2.50-10P |
| 2.70 mm  | 61 mm  | 1 | 4511-2.70-10P |
| 2.90 mm  | 61 mm  | 1 | 4511-2.90-10P |
| 3.00 mm  | 61 mm  | 1 | 4511-3.00-10P |
| 3.10 mm  | 65 mm  | 1 | 4511-3.10-10P |
| 3.25 mm  | 65 mm  | 1 | 4511-3.25-10P |
| 3.30 mm  | 65 mm  | 1 | 4511-3.30-10P |
| 3.50 mm  | 70 mm  | 1 | 4511-3.50-10P |
| 3.80 mm  | 75 mm  | 1 | 4511-3.80-10P |
| 4.00 mm  | 75 mm  | 1 | 4511-4.00-10P |
| 4.20 mm  | 75 mm  | 1 | 4511-4.20-10P |
| 4.50 mm  | 80 mm  | 1 | 4511-4.50-10P |
| 4.80 mm  | 86 mm  | 1 | 4511-4.80-10P |
| 5.00 mm  | 86 mm  | 1 | 4511-5.00-10P |
| 5.20 mm  | 86 mm  | 1 | 4511-5.20-10P |
| 5.50 mm  | 93 mm  | 1 | 4511-5.50-10P |
| 6.00 mm  | 93 mm  | 1 | 4511-6.00-10P |
| 6.20 mm  | 101 mm | 1 | 4511-6.20-10P |
| 6.50 mm  | 101 mm | 1 | 4511-6.50-10P |
| 6.80 mm  | 109 mm | 1 | 4511-6.80-10P |
| 7.00 mm  | 109 mm | 1 | 4511-7.00-10P |
| 7.20 mm  | 109 mm | 1 | 4511-7.20-10P |
| 7.50 mm  | 109 mm | 1 | 4511-7.50-10P |
| 7.80 mm  | 117 mm | 1 | 4511-7.80-10P |
| 8.00 mm  | 117 mm | 1 | 4511-8.00-10P |
| 8.50 mm  | 117 mm | 1 | 4511-8.50-10P |
| 8.60 mm  | 125 mm | 1 | 4511-8.60-10P |
| 8.80 mm  | 125 mm | 1 | 4511-8.80-10P |
| 9.00 mm  | 125 mm | 1 | 4511-9.00-10P |
| 9.20 mm  | 125 mm | 1 | 4511-9.20-10P |
| 9.50 mm  | 125 mm | 1 | 4511-9.50-10P |
| 9.60 mm  | 133 mm | 1 | 4511-9.60-10P |
| 10.00 mm | 133 mm | 1 | 4511-10.00-5P |
| 10.20 mm | 133 mm | 1 | 4511-10.20-5P |
| 10.30 mm | 133 mm | 1 | 4511-10.30-5P |
| 10.50 mm | 133 mm | 1 | 4511-10.50-5P |
| 10.80 mm | 142 mm | 1 | 4511-10.80-5P |
| 11.00 mm | 142 mm | 1 | 4511-11.00-5P |
| 11.50 mm | 142 mm | 1 | 4511-11.50-5P |
| 12.00 mm | 151 mm | 1 | 4511-12.00-5P |
| 12.50 mm | 151 mm | 1 | 4511-12.50-5P |
| 12.80 mm | 151 mm | 1 | 4511-12.80-5P |
| 13.00 mm | 151 mm | 1 | 4511-13.00-5P |

| Ø        | L      |   |               |
|----------|--------|---|---------------|
| 13.50 mm | 160 mm | 1 | 4511-13.50-1P |
| 14.00 mm | 160 mm | 1 | 4511-14.00-1P |
| 14.50 mm | 169 mm | 1 | 4511-14.50-1P |
| 15.00 mm | 169 mm | 1 | 4511-15.00-1P |
| 15.50 mm | 169 mm | 1 | 4511-15.50-1P |
| 16.00 mm | 178 mm | 1 | 4511-16.00-1P |
| 16.50 mm | 184 mm | 1 | 4511-16.50-1P |
| 17.00 mm | 184 mm | 1 | 4511-17.00-1P |
| 17.50 mm | 191 mm | 1 | 4511-17.50-1P |
| 18.00 mm | 191 mm | 1 | 4511-18.00-1P |
| 18.50 mm | 198 mm | 1 | 4511-18.50-1P |
| 19.00 mm | 198 mm | 1 | 4511-19.00-1P |
| 19.50 mm | 205 mm | 1 | 4511-19.50-1P |
| 20.00 mm | 205 mm | 1 | 4511-20.00-1P |

Cobalt HSS-E Drill Bit Set for Metal - 6 Pcs



4511-SET-6

|   |       |   |            |
|---|-------|---|------------|
| X | g     |   |            |
| 6 | 150 g | 1 | 4511-SET-6 |

4411-2.00, 4411-3.00, 4411-4.00, 4411-5.00, 4411-6.00, 4411-8.00

Cobalt HSS-E Drill Bit Set for Metal - 19 Pcs



4511-SET-19

|    |       |   |             |
|----|-------|---|-------------|
| X  | g     |   |             |
| 19 | 600 g | 1 | 4511-SET-19 |

1.0 to 10.0 mm x 0.5 mm

4411-1.00, 4411-1.50, 4411-2.00, 4411-2.50, 4411-3.00, 4411-3.50, 4411-4.00, 4411-4.50, 4411-5.00, 4411-5.50, 4411-6.00, 4411-6.50, 4411-7.00, 4411-7.50, 4411-8.00, 4411-8.50, 4411-9.00, 4411-9.50, 4411-10.00



Cobalt HSS-E Drill Bit Set for Metal - 25 Pcs



**4511-SET-25**



25 1200 g 1 4511-SET-25

1x 1.0, 1.5; 2.0; 2.5; 3.0; 3.5; 4.0; 4.5; 5.0; 5.5; 6.0; 6.5; 7.0; 7.5; 8.0; 8.5; 9.0; 9.5; 10.0; 10.5; 11.0; 11.5; 12; 12.5; 13.0mm



HSS-G Drill Bits for Metal



**4413**



| Ø        | L      |    |            |
|----------|--------|----|------------|
| 1.00 mm  | 34 mm  | 1  | 4413-1.00  |
| 1.50 mm  | 40 mm  | 1  | 4413-1.50  |
| 2.00 mm  | 49 mm  | 1  | 4413-2.00  |
| 2.50 mm  | 57 mm  | 1  | 4413-2.50  |
| 3.00 mm  | 61 mm  | 1  | 4413-3.00  |
| 3.25 mm  | 65 mm  | 1  | 4413-3.25  |
| 3.30 mm  | 65 mm  | 1  | 4413-3.30  |
| 3.50 mm  | 70 mm  | 1  | 4413-3.50  |
| 4.00 mm  | 75 mm  | 1  | 4413-4.00  |
| 4.20 mm  | 75 mm  | 1  | 4413-4.20  |
| 4.25 mm  | 75 mm  | 1  | 4413-4.25  |
| 4.50 mm  | 80 mm  | 1  | 4413-4.50  |
| 5.00 mm  | 86 mm  | 1  | 4413-5.00  |
| 5.50 mm  | 93 mm  | 1  | 4413-5.50  |
| 6.00 mm  | 93 mm  | 1  | 4413-6.00  |
| 6.50 mm  | 101 mm | 1  | 4413-6.50  |
| 6.80 mm  | 109 mm | 1  | 4413-6.80  |
| 7.00 mm  | 109 mm | 1  | 4413-7.00  |
| 7.50 mm  | 109 mm | 1  | 4413-7.50  |
| 8.00 mm  | 117 mm | 1  | 4413-8.00  |
| 8.50 mm  | 117 mm | 1  | 4413-8.50  |
| 9.00 mm  | 125 mm | 1  | 4413-9.00  |
| 9.50 mm  | 125 mm | 1  | 4413-9.50  |
| 10.00 mm | 133 mm | 1  | 4413-10.00 |
| 10.20 mm | 133 mm | 1  | 4413-10.20 |
| 10.50 mm | 133 mm | 25 | 4413-10.50 |
| 11.00 mm | 142 mm | 1  | 4413-11.00 |
| 11.50 mm | 142 mm | 25 | 4413-11.50 |
| 12.00 mm | 151 mm | 1  | 4413-12.00 |
| 12.50 mm | 151 mm | 25 | 4413-12.50 |
| 13.00 mm | 151 mm | 1  | 4413-13.00 |

Size 1 mm up to 4 mm, two drills in each tube



HSS-G Drill Bits for Metal with Industrial Pack



**4513**

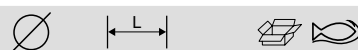

| Ø        | L      |   |               |
|----------|--------|---|---------------|
| 1.00 mm  | 34 mm  | 1 | 4513-1.00-10P |
| 1.50 mm  | 40 mm  | 1 | 4513-1.50-10P |
| 1.75 mm  | 46 mm  | 1 | 4513-1.75-10P |
| 2.00 mm  | 49 mm  | 1 | 4513-2.00-10P |
| 2.50 mm  | 57 mm  | 1 | 4513-2.50-10P |
| 2.70 mm  | 61 mm  | 1 | 4513-2.70-10P |
| 2.90 mm  | 61 mm  | 1 | 4513-2.90-10P |
| 3.00 mm  | 61 mm  | 1 | 4513-3.00-10P |
| 3.10 mm  | 65 mm  | 1 | 4513-3.10-10P |
| 3.25 mm  | 65 mm  | 1 | 4513-3.25-10P |
| 3.30 mm  | 65 mm  | 1 | 4513-3.30-10P |
| 3.50 mm  | 70 mm  | 1 | 4513-3.50-10P |
| 3.80 mm  | 75 mm  | 1 | 4513-3.80-10P |
| 4.00 mm  | 75 mm  | 1 | 4513-4.00-10P |
| 4.20 mm  | 75 mm  | 1 | 4513-4.20-10P |
| 4.50 mm  | 80 mm  | 1 | 4513-4.50-10P |
| 4.80 mm  | 86 mm  | 1 | 4513-4.80-10P |
| 5.00 mm  | 86 mm  | 1 | 4513-5.00-10P |
| 5.20 mm  | 86 mm  | 1 | 4513-5.20-10P |
| 5.50 mm  | 93 mm  | 1 | 4513-5.50-10P |
| 6.00 mm  | 93 mm  | 1 | 4513-6.00-10P |
| 6.20 mm  | 101 mm | 1 | 4513-6.20-10P |
| 6.50 mm  | 101 mm | 1 | 4513-6.50-10P |
| 6.80 mm  | 109 mm | 1 | 4513-6.80-10P |
| 7.00 mm  | 109 mm | 1 | 4513-7.00-10P |
| 7.20 mm  | 109 mm | 1 | 4513-7.20-10P |
| 7.50 mm  | 109 mm | 1 | 4513-7.50-10P |
| 7.80 mm  | 117 mm | 1 | 4513-7.80-10P |
| 8.00 mm  | 117 mm | 1 | 4513-8.00-10P |
| 8.50 mm  | 117 mm | 1 | 4513-8.50-10P |
| 8.60 mm  | 125 mm | 1 | 4513-8.60-10P |
| 8.80 mm  | 125 mm | 1 | 4513-8.80-10P |
| 9.00 mm  | 125 mm | 1 | 4513-9.00-10P |
| 9.20 mm  | 125 mm | 1 | 4513-9.20-10P |
| 9.50 mm  | 125 mm | 1 | 4513-9.50-10P |
| 9.60 mm  | 133 mm | 1 | 4513-9.60-10P |
| 10.00 mm | 133 mm | 1 | 4513-10.00-5P |
| 10.20 mm | 133 mm | 1 | 4513-10.20-5P |
| 10.30 mm | 133 mm | 1 | 4513-10.30-5P |
| 10.50 mm | 133 mm | 1 | 4513-10.50-5P |
| 10.80 mm | 142 mm | 1 | 4513-10.80-5P |
| 11.00 mm | 142 mm | 1 | 4513-11.00-5P |
| 11.50 mm | 142 mm | 1 | 4513-11.50-5P |
| 12.00 mm | 151 mm | 1 | 4513-12.00-5P |
| 12.50 mm | 151 mm | 1 | 4513-12.50-5P |
| 12.80 mm | 151 mm | 1 | 4513-12.80-5P |
| 13.00 mm | 151 mm | 1 | 4513-13.00-5P |
| 13.50 mm | 160 mm | 1 | 4513-13.50-1P |
| 14.00 mm | 160 mm | 1 | 4513-14.00-1P |
| 14.50 mm | 169 mm | 1 | 4513-14.50-1P |
| 15.00 mm | 169 mm | 1 | 4513-15.00-1P |
| 15.50 mm | 178 mm | 1 | 4513-15.50-1P |
| 16.00 mm | 178 mm | 1 | 4513-16.00-1P |
| 16.50 mm | 184 mm | 1 | 4513-16.50-1P |
| 17.00 mm | 184 mm | 1 | 4513-17.00-1P |
| 17.50 mm | 191 mm | 1 | 4513-17.50-1P |
| 18.00 mm | 191 mm | 1 | 4513-18.00-1P |

| Ø        | L      |   |               |
|----------|--------|---|---------------|
| 18.50 mm | 198 mm | 1 | 4513-18.50-1P |
| 19.00 mm | 198 mm | 1 | 4513-19.00-1P |
| 19.50 mm | 205 mm | 1 | 4513-19.50-1P |
| 20.00 mm | 205 mm | 1 | 4513-20.00-1P |

HSS-G Drill Bit Set for Metal - 6 Pcs



**4513-SET-6**



6 150 g 1 4513-SET-6

2.0 to 8.0 mm x 1.0 mm (excl. 7.0 mm)

4413-2.00, 4413-3.00, 4413-4.00, 4413-5.00, 4413-6.00, 4413-8.00



HSS-G Drill Bit Set for Metal - 19 Pcs



**4513-SET-19**



19 600 g 1 4513-SET-19

4413-1.00, 4413-1.50, 4413-2.00, 4413-2.50, 4413-3.00, 4413-3.50, 4413-4.00, 4413-4.50, 4413-5.00, 4413-5.50, 4413-6.00, 4413-6.50, 4413-7.00, 4413-7.50, 4413-8.00, 4413-8.50, 4413-9.00, 4413-9.50, 4413-10.00



### HSS-G Drill Bit Set for Metal - 25 Pcs



| Ø        | L      | Icons | Part No.     |
|----------|--------|-------|--------------|
| 12.50 mm | 151 mm |       | 1 4415-12.50 |
| 13.00 mm | 151 mm |       | 1 4415-13.00 |
| 13.50 mm | 160 mm |       | 1 4415-13.50 |
| 14.00 mm | 160 mm |       | 1 4415-14.00 |
| 14.50 mm | 169 mm |       | 1 4415-14.50 |
| 15.00 mm | 169 mm |       | 1 4415-15.00 |
| 15.50 mm | 178 mm |       | 1 4415-15.50 |
| 16.00 mm | 178 mm |       | 1 4415-16.00 |
| 16.50 mm | 184 mm |       | 1 4415-16.50 |
| 17.00 mm | 184 mm |       | 1 4415-17.00 |
| 17.50 mm | 191 mm |       | 1 4415-17.50 |
| 18.00 mm | 191 mm |       | 1 4415-18.00 |
| 18.50 mm | 198 mm |       | 1 4415-18.50 |
| 19.00 mm | 198 mm |       | 1 4415-19.00 |
| 19.50 mm | 205 mm |       | 1 4415-19.50 |
| 20.00 mm | 205 mm |       | 1 4415-20.00 |

Size 1 mm up to 4 mm, two drills in each tube

### 4513-SET-25



|    |        |       |               |
|----|--------|-------|---------------|
| X  | g      | Icons | Part No.      |
| 25 | 1200 g |       | 1 4513-SET-25 |

1x 1.0; 1.5; 2.0; 2.5; 3.0; 3.5; 4.0; 4.5; 5.0; 5.5; 6.0; 6.5; 7.0; 7.5; 8.0; 8.5; 9.0; 9.5; 10.0; 10.5; 11.0; 11.5; 12; 12.5; 13.0 mm

### HSS-R Drill Bits for Metal



### HSS-R Drill Bits for Metal with Industrial Pack



### 4515

| Ø        | L      | Icons | Part No.         |
|----------|--------|-------|------------------|
| 1.00 mm  | 34 mm  |       | 1 4515-1.00-10P  |
| 1.50 mm  | 40 mm  |       | 1 4515-1.50-10P  |
| 2.00 mm  | 49 mm  |       | 1 4515-2.00-10P  |
| 2.50 mm  | 57 mm  |       | 1 4515-2.50-10P  |
| 3.00 mm  | 61 mm  |       | 1 4515-3.00-10P  |
| 3.25 mm  | 65 mm  |       | 1 4515-3.25-10P  |
| 3.50 mm  | 70 mm  |       | 1 4515-3.50-10P  |
| 4.00 mm  | 75 mm  |       | 1 4515-4.00-10P  |
| 4.25 mm  | 75 mm  |       | 1 4515-4.25-10P  |
| 4.50 mm  | 80 mm  |       | 1 4515-4.50-10P  |
| 5.00 mm  | 86 mm  |       | 1 4515-5.00-10P  |
| 5.50 mm  | 93 mm  |       | 1 4515-5.50-10P  |
| 6.00 mm  | 93 mm  |       | 1 4515-6.00-10P  |
| 6.50 mm  | 101 mm |       | 1 4515-6.50-10P  |
| 7.00 mm  | 109 mm |       | 1 4515-7.00-10P  |
| 7.50 mm  | 109 mm |       | 1 4515-7.50-10P  |
| 8.00 mm  | 117 mm |       | 1 4515-8.00-10P  |
| 8.50 mm  | 117 mm |       | 1 4515-8.50-10P  |
| 9.00 mm  | 125 mm |       | 1 4515-9.00-10P  |
| 9.50 mm  | 125 mm |       | 1 4515-9.50-10P  |
| 10.00 mm | 133 mm |       | 1 4515-10.00-10P |
| 10.50 mm | 133 mm |       | 1 4515-10.50-5P  |
| 11.00 mm | 142 mm |       | 1 4515-11.00-5P  |
| 11.50 mm | 142 mm |       | 1 4515-11.50-5P  |
| 12.00 mm | 151 mm |       | 1 4515-12.00-5P  |
| 12.50 mm | 151 mm |       | 1 4515-12.50-5P  |
| 13.00 mm | 151 mm |       | 1 4515-13.00-5P  |

### 4415



| Ø        | L      | Icons | Part No.     |
|----------|--------|-------|--------------|
| 1.00 mm  | 34 mm  |       | 1 4415-1.00  |
| 1.50 mm  | 40 mm  |       | 1 4415-1.50  |
| 2.00 mm  | 49 mm  |       | 1 4415-2.00  |
| 2.50 mm  | 57 mm  |       | 1 4415-2.50  |
| 3.00 mm  | 61 mm  |       | 1 4415-3.00  |
| 3.25 mm  | 65 mm  |       | 1 4415-3.25  |
| 3.50 mm  | 70 mm  |       | 1 4415-3.50  |
| 4.00 mm  | 75 mm  |       | 1 4415-4.00  |
| 4.25 mm  | 75 mm  |       | 1 4415-4.25  |
| 4.50 mm  | 80 mm  |       | 1 4415-4.50  |
| 5.00 mm  | 86 mm  |       | 1 4415-5.00  |
| 5.50 mm  | 93 mm  |       | 1 4415-5.50  |
| 6.00 mm  | 93 mm  |       | 1 4415-6.00  |
| 6.50 mm  | 101 mm |       | 1 4415-6.50  |
| 7.00 mm  | 109 mm |       | 1 4415-7.00  |
| 7.50 mm  | 109 mm |       | 1 4415-7.50  |
| 8.00 mm  | 117 mm |       | 1 4415-8.00  |
| 8.50 mm  | 117 mm |       | 1 4415-8.50  |
| 9.00 mm  | 125 mm |       | 1 4415-9.00  |
| 10.00 mm | 125 mm |       | 1 4415-10.00 |
| 10.50 mm | 133 mm |       | 1 4415-10.50 |
| 11.00 mm | 142 mm |       | 1 4415-11.00 |
| 11.50 mm | 142 mm |       | 1 4415-11.50 |
| 12.00 mm | 151 mm |       | 1 4415-12.00 |

### HSS-R Drill Bit Set for Metal - 19 Pcs



### 4515-SET-19



|    |       |       |               |
|----|-------|-------|---------------|
| X  | g     | Icons | Part No.      |
| 19 | 600 g |       | 1 4515-SET-19 |

1x 1.0mm; 1.5mm; 2.0mm; 2.5mm; 3.0mm; 3.5mm; 4.0mm; 4.5mm; 5.0mm; 5.5mm; 6.0mm; 6.5mm; 7mm; 7.5mm; 8mm; 8.5mm; 9.0mm; 9.5mm; 10mm

### HSS-R Drill Bit Set for Metal - 25 pcs



### 4515-SET-25



|    |        |       |               |
|----|--------|-------|---------------|
| X  | g      | Icons | Part No.      |
| 25 | 1200 g |       | 1 4515-SET-25 |

1x 1.0; 1.5; 2.0; 2.5; 3.0; 3.5; 4.0; 4.5; 5.0; 5.5; 6.0; 6.5; 7; 7.5; 8; 8.5; 9.0; 9.5; 10; 10.5; 11; 11.5; 12; 12.5; 13 mm

### Step Drills for Metal Sheet 4 mm-12 mm



### 228-SD

|       |                                 |          |          |
|-------|---------------------------------|----------|----------|
| Icons | Part No.                        | Quantity | Part No. |
|       | 6.35 mm 4-5-6-7-8-9-10-11-12 mm | 24       | 228-SD   |



Step Drills for Metal sheet 4 mm-22 mm



**229-SD**

|       |                               |    |        |
|-------|-------------------------------|----|--------|
|       |                               |    |        |
| 10 mm | 4-6-8-10-12-14-16-18-20-22 mm | 24 | 229-SD |

Step Drills for Metal Sheet 6.5 mm-40.5 mm



**234-SD**

|       |   |    |        |
|-------|---|----|--------|
|       |   |    |        |
| 10 mm | 6.5-8.5-10.5-12.5-16.5-20.5-25.5-29-32.5-36.5-40.5 mm | 25 | 234-SD |

Auger Drill Bits for Wood



**9626**

|         |   |             |
|---------|---|-------------|
|         |   |             |
| 6.0 mm  | 1 | 9626-6      |
| 7.0 mm  | 1 | 9626-7      |
| 8.0 mm  | 1 | 9626-8      |
| 9.0 mm  | 1 | 9626-9      |
| 10.0 mm | 1 | 9626-10     |
| 11.0 mm | 1 | 9626-11     |
| 12.0 mm | 1 | 9626-12     |
| 13.0 mm | 1 | 9626-13     |
| 14.0 mm | 1 | 9626-14     |
| 15.0 mm | 1 | 9626-15     |
| 16.0 mm | 1 | 9626-16     |
| 18.0 mm | 1 | 9626-18     |
| 20.0 mm | 1 | 9626-20     |
| 22.0 mm | 1 | 9626-22     |
| 23.0 mm | 1 | 9626-23     |
| 24.0 mm | 1 | 9626-24     |
| 25.0 mm | 1 | 9626-25     |
| 26.0 mm | 1 | 9626-26     |
| 28.0 mm | 1 | 9626-28     |
| 30.0 mm | 1 | 9626-30     |
| 32.0 mm | 1 | 9626-32     |
| 35.0 mm | 1 | 9626-35     |
| 6.0 mm  | 1 | 9627-6-460  |
| 8.0 mm  | 1 | 9627-8-460  |
| 10.0 mm | 1 | 9627-10-460 |
| 12.0 mm | 1 | 9627-12-460 |
| 14.0 mm | 1 | 9627-14-460 |
| 16.0 mm | 1 | 9627-16-460 |
| 18.0 mm | 1 | 9627-18-460 |
| 20.0 mm | 1 | 9627-20-460 |
| 22.0 mm | 1 | 9627-22-460 |
| 24.0 mm | 1 | 9627-24-460 |
| 26.0 mm | 1 | 9627-26-460 |
| 28.0 mm | 1 | 9627-28-460 |
| 30.0 mm | 1 | 9627-30-460 |
| 32.0 mm | 1 | 9627-32-460 |

Step Drills for Metal sheet 5 mm-35 mm



**230-SD**

|         |  |    |        |
|---------|--|----|--------|
|         |  |    |        |
| 12.7 mm | 5-13-15-17-19-21-23-25-27-29-31-33-35 mm | 25 | 230-SD |

HSS Step Drill Set - 3 Pcs



**228-SET**

|   |       |   |            |
|---|-------|---|------------|
|   |       |   |            |
| 3 | 560 g | 1 | 228-SET-SD |

|        |        |        |
|--------|--------|--------|
|        |        |        |
| 228-SD | 229-SD | 230-SD |

Step Drills for Metal Sheet 6 mm-37 mm



**232-SD**

|       |  |   |        |
|-------|--|---|--------|
|       |  |   |        |
| 10 mm | 6-9-12.5-15.2-18.6-20.4-22.5-26-28.3-30.5-34-37 mm | 1 | 232-SD |

HSS-G Countersink Drill Bits for Metal



**4435**

|         |       |   |           |
|---------|-------|---|-----------|
|         |       |   |           |
| 12.4 mm | 56 mm | 1 | 4435-12.4 |

Auger Bit Set - 6 Pcs



**SB-9526/S6**

|   |    |            |
|---|----|------------|
|   |    |            |
| 6 | 20 | SB-9526/S6 |

9526-10, 9526-13, 9526-19, 9526-22, 9526-25  
9526-16



## Flat Drill Bits for Wood



### 9629

| Ø       | L      |   |             |
|---------|--------|---|-------------|
| 6.0 mm  | 152 mm | 1 | 9629-6      |
| 8.0 mm  | 152 mm | 1 | 9629-8      |
| 10.0 mm | 152 mm | 1 | 9629-10     |
| 12.0 mm | 152 mm | 1 | 9629-12     |
| 13.0 mm | 152 mm | 1 | 9629-13     |
| 14.0 mm | 152 mm | 1 | 9629-14     |
| 16.0 mm | 152 mm | 1 | 9629-16     |
| 17.0 mm | 152 mm | 1 | 9629-17     |
| 18.0 mm | 152 mm | 1 | 9629-18     |
| 19.0 mm | 152 mm | 1 | 9629-19     |
| 20.0 mm | 152 mm | 1 | 9629-20     |
| 22.0 mm | 152 mm | 1 | 9629-22     |
| 24.0 mm | 152 mm | 1 | 9629-24     |
| 25.0 mm | 152 mm | 1 | 9629-25     |
| 26.0 mm | 152 mm | 1 | 9629-26     |
| 28.0 mm | 152 mm | 1 | 9629-28     |
| 30.0 mm | 152 mm | 1 | 9629-30     |
| 32.0 mm | 152 mm | 1 | 9629-32     |
| 35.0 mm | 152 mm | 1 | 9629-35     |
| 36.0 mm | 152 mm | 1 | 9629-36     |
| 38.0 mm | 152 mm | 1 | 9629-38     |
| 40.0 mm | 152 mm | 1 | 9629-40     |
| 6.0 mm  | 400 mm | 1 | 9631-6-400  |
| 8.0 mm  | 400 mm | 1 | 9631-8-400  |
| 10.0 mm | 400 mm | 1 | 9631-10-400 |
| 12.0 mm | 400 mm | 1 | 9631-12-400 |
| 13.0 mm | 400 mm | 1 | 9631-13-400 |
| 14.0 mm | 400 mm | 1 | 9631-14-400 |
| 16.0 mm | 400 mm | 1 | 9631-16-400 |
| 18.0 mm | 400 mm | 1 | 9631-18-400 |
| 19.0 mm | 400 mm | 1 | 9631-19-400 |
| 20.0 mm | 400 mm | 1 | 9631-20-400 |
| 22.0 mm | 400 mm | 1 | 9631-22-400 |
| 24.0 mm | 400 mm | 1 | 9631-24-400 |
| 25.0 mm | 400 mm | 1 | 9631-25-400 |
| 28.0 mm | 400 mm | 1 | 9631-28-400 |
| 30.0 mm | 400 mm | 1 | 9631-30-400 |
| 32.0 mm | 400 mm | 1 | 9631-32-400 |
| 35.0 mm | 400 mm | 1 | 9631-35-400 |
| 38.0 mm | 400 mm | 1 | 9631-38-400 |

## Flat Drill Bit Set for Wood - 8 pcs



### 9629-SET-8

| X | g     |    |            |
|---|-------|----|------------|
| 8 | 630 g | 12 | 9629-SET-8 |

9629-12, 9629-16, 9629-18, 9629-20, 9629-22, 9629-25, 9629-28, 9629-32



## Speed Cut Drill Bit Set for Wood - 6 Pcs



### 9656-SET-6

| X | g     |   |            |
|---|-------|---|------------|
| 6 | 720 g | 1 | 9656-SET-6 |

## Brad Point Drill Bits for Wood



### 9646

| Ø     |  |   |             |
|-------|--|---|-------------|
| 3 mm  |  | 1 | 9646-3      |
| 4 mm  |  | 1 | 9646-4      |
| 5 mm  |  | 1 | 9646-5      |
| 6 mm  |  | 1 | 9646-6      |
| 7 mm  |  | 1 | 9646-7      |
| 8 mm  |  | 1 | 9646-8      |
| 9 mm  |  | 1 | 9646-9      |
| 10 mm |  | 1 | 9646-10     |
| 11 mm |  | 1 | 9646-11     |
| 12 mm |  | 1 | 9646-12     |
| 13 mm |  | 1 | 9646-13     |
| 14 mm |  | 1 | 9646-14     |
| 15 mm |  | 1 | 9646-15     |
| 16 mm |  | 1 | 9646-16     |
| 18 mm |  | 1 | 9646-18     |
| 20 mm |  | 1 | 9646-20     |
| 6 mm  |  | 1 | 9646-6-250  |
| 8 mm  |  | 1 | 9646-8-250  |
| 10 mm |  | 1 | 9646-10-250 |
| 12 mm |  | 1 | 9646-12-250 |

## Brad Point Drill Bit Set for Wood - 5 pcs



### 9646-SET-5

| X | g     |   |            |
|---|-------|---|------------|
| 5 | 110 g | 1 | 9646-SET-5 |

9646-4, 9646-5, 9646-6, 9646-8, 9646-10

## Brad Point Drill Bit Set for Wood - 8 pcs



### 9646-SET-8

| X | g     |   |            |
|---|-------|---|------------|
| 8 | 230 g | 1 | 9646-SET-8 |

9646-3, 9646-4, 9646-5, 9646-6, 9646-7, 9646-8, 9646-9, 9646-10

## Expansive Drill Bits for Wood



### 9528

| Ø        |  |    |               |
|----------|--|----|---------------|
| 15-45 mm |  | 10 | 9528-MD-15-45 |





Drill Bits for Tiles



**4626**

| Ø     | L     | Icons | Part No.    |
|-------|-------|-------|-------------|
| 4 mm  | 58 mm |       | 1 4626-4.0  |
| 5 mm  | 58 mm |       | 1 4626-5.0  |
| 6 mm  | 58 mm |       | 1 4626-6.0  |
| 8 mm  | 78 mm |       | 1 4626-8.0  |
| 10 mm | 98 mm |       | 1 4626-10.0 |

Extension Shaft 305 mm 1/4" Quick-Change



**9625-6.35QC**

| Ø       | L      | Icons | Part No.      |
|---------|--------|-------|---------------|
| 6.35 mm | 305 mm |       | 1 9625-6.35QC |

1/4" Diamond Torsion Screwdriver Bits for Phillips Dry Wall Head Screws 25 mm



**63D/PH2G**

| Icons | Part No.   |
|-------|------------|
|       | 5          |
|       | PH2G       |
|       | 1 63D/PH2G |

Multi-Purpose Drill Bits for Tiles, Natural Stone, Wood and Plastic



**4629**

| Ø       | L      | Icons | Part No.    |
|---------|--------|-------|-------------|
| 4.0 mm  | 75 mm  |       | 1 4629-4.0  |
| 5.0 mm  | 85 mm  |       | 1 4629-5.0  |
| 6.0 mm  | 100 mm |       | 1 4629-6.0  |
| 8.0 mm  | 120 mm |       | 1 4629-8.0  |
| 10.0 mm | 120 mm |       | 1 4629-10.0 |

Extension Shafts 330 mm



**9525**

| Ø     | L | Icons | Part No.  |
|-------|---|-------|-----------|
| 7 mm  |   |       | 1 9525-7  |
| 10 mm |   |       | 1 9525-10 |

1/4" Diamond Torsion Screwdriver Bits for Pozidriv Head Screws 25 mm



**63D/PZ**

| Icons | Part No.  |
|-------|-----------|
|       | 5         |
|       | 1         |
|       | 1 63D/PZ1 |
|       | 5         |
|       | 2         |
|       | 1 63D/PZ2 |

Drill Set Multi-Purpose with Carbide Tip - 5 pcs



**4629-SET-5**

| Icons | Part No.      |
|-------|---------------|
|       | 5             |
|       | 165 g         |
|       | 10 4629-SET-5 |

4629-8.0, 4629-10.0, 4629-4.0, 4629-5.0, 4629-6.0

**SCREWDRIVER BITS**

1/4" Diamond Torsion Screwdriver Bits for Phillips Head Screws 25 mm



**63D/PH**

| Icons | Part No.  |
|-------|-----------|
|       | 5         |
|       | 3         |
|       | 1 63D/PH3 |

1/4" Diamond Torsion Screwdriver Bits for TORX® Head Screws 25 mm



**63D/T**

| Icons | Part No.  |
|-------|-----------|
|       | 5         |
|       | T10       |
|       | 1 63D/T10 |
|       | 5         |
|       | T15       |
|       | 1 63D/T15 |
|       | 5         |
|       | T40       |
|       | 1 63D/T40 |

1/4" Diamond Torsion Screwdriver Bits for Pozidriv Head Screws 50 mm - 5 Pcs/ Plastic Box



**63D/50PZ**

|   |   |   |           |  |
|---|---|---|-----------|--|
|   |   |   |           |  |
| 5 | 1 | 1 | 63D/50PZ1 |  |
| 5 | 2 | 1 | 63D/50PZ2 |  |
| 5 | 3 | 1 | 63D/50PZ3 |  |

1/4" Tin Torsion Screwdriver Bits for Pozidriv Head Screws 25 mm



**62TIN/PZ**

|    |   |   |           |
|----|---|---|-----------|
|    |   |   |           |
| 10 | 1 | 1 | 62TIN/PZ1 |
| 10 | 2 | 1 | 62TIN/PZ2 |
| 10 | 3 | 1 | 62TIN/PZ3 |

1/4" Tin Torsion Screwdriver Bits for Pozidriv Head Screws 50 mm



**62TIN/50PZ**

|   |   |   |             |
|---|---|---|-------------|
|   |   |   |             |
| 5 | 1 | 1 | 62TIN/50PZ1 |
| 5 | 2 | 1 | 62TIN/50PZ2 |
| 5 | 3 | 1 | 62TIN/50PZ3 |

1/4" Diamond Torsion Screwdriver Bits Set with Bit Holder for Phillips/Pozidriv/TORX® Head Screws



**63D/7**

|   |                 |   |         |
|---|-----------------|---|---------|
|   |                 |   |         |
| 7 | 20 x 50 x 80 mm | 1 | 63D/7-1 |

|                                    |  |  |
|------------------------------------|--|--|
| 63D/PH2                            |  |  |
| 63D/PZ2                            |  |  |
| 63D/T10, 63D/T15, 63D/T25, 63D/T30 |  |  |

1/4" Tin Torsion Screwdriver Bits for TORX® Head Screws 25 mm



**62TIN/T**

|    |     |   |           |
|----|-----|---|-----------|
|    |     |   |           |
| 10 | T15 | 1 | 62TIN/T15 |
| 10 | T20 | 1 | 62TIN/T20 |
| 10 | T25 | 1 | 62TIN/T25 |
| 10 | T30 | 1 | 62TIN/T30 |

1/4" Tin Torsion Bit Set for Phillips/Pozidriv/TORX® Head Screws



**62TIN/7**

|   |                 |   |           |
|---|-----------------|---|-----------|
|   |                 |   |           |
| 7 | 22 x 65 x 75 mm | 1 | 62TIN/7-1 |

|  |  |  |
|--|--|--|
| 62TIN/PH2                                  |  |  |
| 62TIN/PZ2                                  |  |  |
| 62TIN/T15, 62TIN/T20, 62TIN/T25, 62TIN/T30 |  |  |

1/4" Tin Torsion Screwdriver Bits for Phillips Head Screws 25 mm



**62TIN/PH**

|    |   |   |           |
|----|---|---|-----------|
|    |   |   |           |
| 10 | 1 | 1 | 62TIN/PH1 |

1/4" Tin Torsion Screwdriver Bits for Phillips Head Screws 50 mm



**62TIN/50PH**

|   |   |   |             |
|---|---|---|-------------|
|   |   |   |             |
| 5 | 1 | 1 | 62TIN/50PH1 |
| 5 | 3 | 1 | 62TIN/50PH3 |

1/4" ACR Torsion Screwdriver Bits for Phillips Head Screws 25 mm



**64A/PH**

|    |   |   |         |
|----|---|---|---------|
|    |   |   |         |
| 10 | 1 | 1 | 64A/PH1 |
| 10 | 3 | 1 | 64A/PH3 |



1/4" ACR Torsion Screwdriver Bits for Pozidriv Head Screws 25 mm



**64A/PZ**

| Icon | Icon | Icon | Icon    |
|------|------|------|---------|
|      |      |      |         |
| 10   | 1    | 1    | 64A/PZ1 |
| 10   | 3    | 1    | 64A/PZ3 |

1/4" Torsion Screwdriver Bits for Phillips Head Screws 25 mm



**60T/PH**

| Icon | Icon | Icon | Icon    |
|------|------|------|---------|
|      |      |      |         |
| 10   | 1    | 1    | 60T/PH1 |
| 10   | 2    | 1    | 60T/PH2 |
| 10   | 3    | 1    | 60T/PH3 |

1/4" Torsion Screwdriver Bits for Pozidriv Head Screws 25 mm



**60T/PZ**

| Icon | Icon | Icon | Icon    |
|------|------|------|---------|
|      |      |      |         |
| 10   | 1    | 1    | 60T/PZ1 |
| 10   | 2    | 1    | 60T/PZ2 |
| 10   | 3    | 1    | 60T/PZ3 |

1/4" Torsion Screwdriver Bits for TORX® Head Screws 25 mm



**60T/T**

| Icon | Icon | Icon | Icon    |
|------|------|------|---------|
|      |      |      |         |
| 10   | T7   | 1    | 60T/T7  |
| 10   | T9   | 1    | 60T/T9  |
| 10   | T15  | 1    | 60T/T15 |
| 10   | T20  | 1    | 60T/T20 |
| 10   | T25  | 1    | 60T/T25 |
| 10   | T27  | 1    | 60T/T27 |
| 10   | T40  | 1    | 60T/T40 |

1/4" Torsion Bit Set for Phillips/Pozidriv/TORX® head screws - 7 Pcs



**60T/7**

| Icon | Icon            | Icon | Icon    |
|------|-----------------|------|---------|
|      |                 |      |         |
| 7    | 22 x 65 x 75 mm | 1    | 60T/7-1 |

**60T/PH2**



**60T/PZ2**



**60T/T10, 60T/T15, 60T/T20, 60T/T30**



1/4" Torsion Bit Set for Phillips/TORX® head screws - 17 Pcs



**60T/17**

| Icon | Icon            | Icon | Icon     |
|------|-----------------|------|----------|
|      |                 |      |          |
| 17   | 27 x 73 x 82 mm | 1    | 60T/17-1 |

**60T/PH1, 60T/PH2**



**60T/T7, 60T/T8, 60T/T9, 60T/T10, 60T/T15x 2, 60T/T20x 2, 60T/T25x 2, 60T/T27, 60T/T30x 2, 60T/T40**



1/4" Torsion Bit Set for Slotted/Phillips/Pozidriv/TORX®/Hex head screws - 31 Pcs



**60T/31**

| Icon | Icon             | Icon | Icon     |
|------|------------------|------|----------|
|      |                  |      |          |
| 31   | 42 x 65 x 110 mm | 1    | 60T/31-1 |

**59S/0.6-4.5, 59S/0.8-5.5**



**60T/PH1, 60T/PH2x 3, 60T/PH3**



**59S/PH2Gx 2**



**60T/PZ1, 60T/PZ2x 3, 60T/PZ3**



**60T/T10, 60T/T15x 3, 60T/T20x 3, 60T/T25x 2, 60T/T27, 60T/T30x 2**



**59S/H3, 59S/H4, 59S/H5, 59S/H6**



1/4" Extra Hard Torsion Screwdriver Bits for Phillips Head Screws 25 mm



**61H/PH**

| Icon | Icon | Icon | Icon    |
|------|------|------|---------|
|      |      |      |         |
| 10   | 1    | 1    | 61H/PH1 |
| 10   | 2    | 1    | 61H/PH2 |
| 5    | 3    | 1    | 61H/PH3 |

1/4" Extra Hard Torsion Screwdriver Bits for Phillips Head Screws 50 mm



**61H/50PH**

|   |   |   |           |
|---|---|---|-----------|
|   |   |   |           |
| 5 | 1 | 1 | 61H/50PH1 |

1/4" Extra Hard Torsion Screwdriver Bits for TORX® Head Screws 50 mm



**61H/50T**

|   |     |   |           |
|---|-----|---|-----------|
|   |     |   |           |
| 5 | T10 | 1 | 61H/50T10 |
| 5 | T15 | 1 | 61H/50T15 |
| 5 | T25 | 1 | 61H/50T25 |
| 5 | T30 | 1 | 61H/50T30 |

1/4" Impact Torsion Screwdriver Bits for Pozidriv Head Screws 25 mm



**66IM/PZ**

|   |   |   |             |
|---|---|---|-------------|
|   |   |   |             |
| 2 | 1 | 1 | 66IM/PZ1-2P |
| 2 | 2 | 1 | 66IM/PZ2-2P |
| 2 | 3 | 1 | 66IM/PZ3-2P |

1/4" Extra Hard Torsion Screwdriver Bits for Pozidriv Head Screws 25 mm



**61H/PZ**

|   |   |   |         |
|---|---|---|---------|
|   |   |   |         |
| 5 | 3 | 1 | 61H/PZ3 |

1/4" Extra Hard Torsion Screwdriver Bits for TORX® Head Screws 25 mm



**61H/T**

|    |     |   |         |
|----|-----|---|---------|
|    |     |   |         |
| 10 | T10 | 1 | 61H/T10 |
| 10 | T15 | 1 | 61H/T15 |
| 10 | T20 | 1 | 61H/T20 |
| 10 | T25 | 1 | 61H/T25 |
| 5  | T40 | 1 | 61H/T40 |

1/4" Impact Torsion Screwdriver Bits for TORX® Head Screws 25 mm



**66IM/T**

|   |     |   |              |
|---|-----|---|--------------|
|   |     |   |              |
| 2 | T10 | 1 | 66IM/T10C-2P |
| 2 | T15 | 1 | 66IM/T15C-2P |
| 2 | T20 | 1 | 66IM/T20C-2P |
| 2 | T25 | 1 | 66IM/T25C-2P |
| 2 | T27 | 1 | 66IM/T27C-2P |
| 2 | T20 | 1 | 66IM/T30C-2P |
| 2 | T40 | 1 | 66IM/T40C-2P |

1/4" Extra Hard Torsion Screwdriver Bits for Pozidriv Head Screws 50 mm



**61H/50PZ**

|   |   |   |           |
|---|---|---|-----------|
|   |   |   |           |
| 5 | 1 | 1 | 61H/50PZ1 |
| 5 | 2 | 1 | 61H/50PZ2 |
| 5 | 3 | 1 | 61H/50PZ3 |

1/4" Impact Torsion Screwdriver Bits for Phillips Head Screws 25 mm



**66IM/PH**

|   |   |   |             |
|---|---|---|-------------|
|   |   |   |             |
| 2 | 1 | 1 | 66IM/PH1-2P |
| 2 | 2 | 1 | 66IM/PH2-2P |
| 2 | 3 | 1 | 66IM/PH3-2P |

1/4" Impact Torsion Screwdriver Bits for Phillips Head Screws 50 mm



**66IM/50PH**

|   |   |   |               |
|---|---|---|---------------|
|   |   |   |               |
| 2 | 1 | 1 | 66IM/50PH1-2P |
| 2 | 2 | 1 | 66IM/50PH2-2P |
| 2 | 3 | 1 | 66IM/50PH3-2P |



1/4" Impact Torsion Screwdriver Bits for Pozidriv Head Screws 50 mm



**66IM/50PZ**

|   |   |   |               |
|---|---|---|---------------|
|   |   |   |               |
| 2 | 1 | 1 | 66IM/50PZ1-2P |
| 2 | 2 | 1 | 66IM/50PZ2-2P |
| 2 | 3 | 1 | 66IM/50PZ3-2P |

1/4" Impact Torsion Bit Set for Phillips/Pozidriv/TORX® with Soft Plastic Holder, 25 mm bits- 10 Pcs



**66IM/10C-1**

|    |                  |   |            |
|----|------------------|---|------------|
|    |                  |   |            |
| 10 | 10 x 50 x 140 mm | 1 | 66IM/10C-1 |

|   |  |  |
|---|--|--|
|   |  |  |
| 66IM/50PH2-2Px 2, 66IM/50PH3-2P                   |  |  |
| 66IM/50PZ2-2Px 2, 66IM/50PZ3-2P                   |  |  |
| 66IM/50T20C-2Px 2, 66IM/50T25C-2P, 66IM/50T30C-2P |  |  |

1/4" Impact Torsion Screwdriver Bits for TORX® Head Screws 50 mm



**66IM/50TC**

|   |    |   |                |
|---|----|---|----------------|
|   |    |   |                |
| 2 | 10 | 1 | 66IM/50T10C-2P |
| 2 | 15 | 1 | 66IM/50T15C-2P |
| 2 | 20 | 1 | 66IM/50T20C-2P |
| 2 | 25 | 1 | 66IM/50T25C-2P |
| 2 | 27 | 1 | 66IM/50T27C-2P |
| 2 | 30 | 1 | 66IM/50T30C-2P |
| 2 | 40 | 1 | 66IM/50T40C-2P |

1/4" Standard Screwdriver Bits for Slotted Head Screws 25 mm



1/4" Standard Screwdriver Bits for Phillips Head Screws 25 mm



**59S/PH**

|     |    |     |             |
|-----|----|-----|-------------|
|     |    |     |             |
| 10  | 0  | 1   | 59S/PH0     |
| 3   | 0  | 1   | 59S/PH0-3P  |
| 3   | 1  | 1   | 59S/PH1-3P  |
| 30  | 1  | 1   | 59S/PH1-30P |
| 100 | *1 | 100 | 59S/PH1-IP  |
| 500 | 1  | 500 | 59S/PH1-IPB |
| 10  | 2  | 1   | 59S/PH2     |
| 3   | 2  | 1   | 59S/PH2-3P  |
| 30  | 2  | 1   | 59S/PH2-30P |
| 100 | *2 | 100 | 59S/PH2-IP  |
| 500 | *2 | 500 | 59S/PH2-IPB |
| 3   | 3  | 1   | 59S/PH3-3P  |
| 30  | 3  | 1   | 59S/PH3-30P |
| 500 | 3  | 500 | 59S/PH3-IPB |
| 10  | 4  | 1   | 59S/PH4     |
| 3   | 4  | 1   | 59S/PH4-3P  |

1/4" Impact Torsion Bit Set for Phillips/Pozidriv/TORX® with Soft Plastic Holder, 50 mm bits - 11 Pcs



**66IM/11C-1**

|    |                  |   |            |
|----|------------------|---|------------|
|    |                  |   |            |
| 11 | 25 x 37 x 140 mm | 1 | 66IM/11C-1 |

|   |  |  |
|---|--|--|
|   |  |  |
| 66IM/PH2-2Px 2, 66IM/PH3-2P                 |  |  |
| 66IM/PZ2-2Px 2, 66IM/PZ3-2P                 |  |  |
| 66IM/T20C-2Px 2, 66IM/T25C-2P, 66IM/T30C-2P |  |  |
| KMT753-QR-1P                                |  |  |

**59S/**

|    |         |   |                |
|----|---------|---|----------------|
|    |         |   |                |
| 10 | 3.0 mm  | 1 | 59S/0.5-3.0    |
| 3  | 3.0 mm  | 1 | 59S/0.5-3.0-3P |
| 10 | 4.0 mm  | 1 | 59S/0.5-4.0    |
| 3  | 4.0 mm  | 1 | 59S/0.5-4.0-3P |
| 10 | 3.5 mm  | 1 | 59S/0.6-3.5    |
| 3  | 3.5 mm  | 1 | 59S/0.6-3.5-3P |
| 10 | 4.5 mm  | 1 | 59S/0.6-4.5    |
| 3  | 4.5 mm  | 1 | 59S/0.6-4.5-3P |
| 10 | 5.5 mm  | 1 | 59S/0.8-5.5    |
| 3  | 5.5 mm  | 1 | 59S/0.8-5.5-3P |
| 10 | 5.5 mm  | 1 | 59S/1.0-5.5    |
| 3  | 5.5 mm  | 1 | 59S/1.0-5.5-3P |
| 10 | 6.5 mm  | 1 | 59S/1.2-6.5    |
| 3  | 6.5 mm  | 1 | 59S/1.2-6.5-3P |
| 10 | 8.0 mm  | 1 | 59S/1.2-8.0    |
| 3  | 8.0 mm  | 1 | 59S/1.2-8.0-3P |
| 10 | 9.0 mm  | 1 | 59S/1.6-9.0    |
| 10 | 10 mm   | 1 | 59S/1.6-10     |
| 3  | 9.0 mm  | 1 | 59S/1.6-9.0-3P |
| 3  | 10.0 mm | 1 | 59S/1.6-10-3P  |

1/4" Standard Screwdriver Bits for Phillips Dry Wall Head Screws 25 mm



**59S/PH2G**

|    |       |   |              |
|----|-------|---|--------------|
|    |       |   |              |
| 3  | PH 2G | 1 | 59S/PH2G-3P  |
| 30 | PH2G  | 1 | 59S/PH2G-30P |



1/4" Standard Screwdriver Bits for Pozidriv Head Screws 25 mm



59S/PZ

| X   | Icon | Icon | Icon        | Icon |
|-----|------|------|-------------|------|
| 10  | 0    | 1    | 59S/PZ0     |      |
| 3   | 0    | 1    | 59S/PZ0-3P  |      |
| 10  | 1    | 1    | 59S/PZ1     |      |
| 3   | 1    | 1    | 59S/PZ1-3P  |      |
| 30  | 1    | 1    | 59S/PZ1-30P |      |
| 100 | *1   | 100  | 59S/PZ1-IP  |      |
| 500 | *1   | 500  | 59S/PZ1-IPB |      |
| 3   | 2    | 1    | 59S/PZ2-3P  |      |
| 30  | 2    | 1    | 59S/PZ2-30P |      |
| 100 | *2   | 100  | 59S/PZ2-IP  |      |
| 500 | *2   | 500  | 59S/PZ2-IPB |      |
| 10  | 3    | 1    | 59S/PZ3     |      |
| 3   | 3    | 1    | 59S/PZ3-3P  |      |
| 30  | 3    | 1    | 59S/PZ3-30P |      |
| 500 | 3    | 500  | 59S/PZ3-IPB |      |
| 10  | 4    | 1    | 59S/PZ4     |      |

1/4" Standard Screwdriver Bits for TORX® Head Screws 25 mm



59S/T

| X  | Icon | Icon | Icon       | Icon |
|----|------|------|------------|------|
| 5  | T3   | 1    | 59S/T3     |      |
| 3  | T3   | 1    | 59S/T3-3P  |      |
| 5  | T4   | 1    | 59S/T4     |      |
| 3  | T4   | 1    | 59S/T4-3P  |      |
| 5  | T5   | 1    | 59S/T5     |      |
| 3  | T5   | 1    | 59S/T5-3P  |      |
| 10 | T6   | 1    | 59S/T6     |      |
| 3  | T6   | 1    | 59S/T6-3P  |      |
| 10 | T7   | 1    | 59S/T7     |      |
| 3  | T7   | 1    | 59S/T7-3P  |      |
| 10 | T8   | 1    | 59S/T8     |      |
| 3  | T8   | 1    | 59S/T8-3P  |      |
| 10 | T9   | 1    | 59S/T9     |      |
| 3  | T9   | 1    | 59S/T9-3P  |      |
| 10 | T10  | 1    | 59S/T10    |      |
| 3  | T10  | 1    | 59S/T10-3P |      |

| X  | Icon | Icon | Icon        | Icon |
|----|------|------|-------------|------|
| 30 | T10  | 1    | 59S/T10-30P |      |
| 10 | T15  | 1    | 59S/T15-10P |      |
| 3  | T15  | 1    | 59S/T15-3P  |      |
| 30 | T15  | 1    | 59S/T15-30P |      |
| 3  | T20  | 1    | 59S/T20-3P  |      |
| 30 | T20  | 1    | 59S/T20-30P |      |
| 10 | T25  | 1    | 59S/T25     |      |
| 3  | T25  | 1    | 59S/T25-3P  |      |
| 30 | T25  | 1    | 59S/T25-30P |      |
| 10 | T27  | 1    | 59S/T27     |      |
| 3  | T27  | 1    | 59S/T27-3P  |      |
| 5  | T30  | 1    | 59S/T30-10P |      |
| 3  | T30  | 1    | 59S/T30-3P  |      |
| 30 | T30  | 1    | 59S/T30-30P |      |
| 5  | T40  | 1    | 59S/T40     |      |
| 3  | T40  | 1    | 59S/T40-3P  |      |
| 30 | T40  | 1    | 59S/T40-30P |      |
| 3  | T45  | 1    | 59S/T45-3P  |      |
| 5  | T45  | 1    | 59S/T45-5P  |      |
| 5  | T50  | 1    | 59S/T50     |      |
| 3  | T50  | 1    | 59S/T50-3P  |      |

1/4" Standard Screwdriver Conical Bits for Torx® Head Screws 25 mm



59S/TCS

| X  | Icon | Icon | Icon      | Icon |
|----|------|------|-----------|------|
| 10 | T10  | 1    | 59S/T10CS |      |
| 10 | T15  | 1    | 59S/T15CS |      |
| 10 | T20  | 1    | 59S/T20CS |      |
| 10 | T25  | 1    | 59S/T25CS |      |
| 10 | T27  | 1    | 59S/T27CS |      |
| 10 | T30  | 1    | 59S/T30CS |      |
| 10 | T40  | 1    | 59S/T40CS |      |

1/4" Standard Screwdriver Bits for TORX® Tamper-Resistant Screws 25 mm



59S/TR

| X | Icon | Icon | Icon       | Icon |
|---|------|------|------------|------|
| 5 | TR 7 | 1    | 59S/TR7    |      |
| 3 | TR7  | 1    | 59S/TR7-3P |      |

| X | Icon  | Icon | Icon        | Icon |
|---|-------|------|-------------|------|
| 5 | TR 8  | 1    | 59S/TR8     |      |
| 3 | TR8   | 1    | 59S/TR8-3P  |      |
| 5 | TR 9  | 1    | 59S/TR9     |      |
| 3 | TR9   | 1    | 59S/TR9-3P  |      |
| 5 | TR 10 | 1    | 59S/TR10    |      |
| 3 | TR 10 | 1    | 59S/TR10-3P |      |
| 5 | TR 15 | 1    | 59S/TR15    |      |
| 3 | TR 15 | 1    | 59S/TR15-3P |      |
| 5 | TR 20 | 1    | 59S/TR20    |      |
| 3 | TR 20 | 1    | 59S/TR20-3P |      |
| 5 | TR 25 | 1    | 59S/TR25    |      |
| 3 | TR 25 | 1    | 59S/TR25-3P |      |
| 5 | TR 27 | 1    | 59S/TR27    |      |
| 3 | TR 27 | 1    | 59S/TR27-3P |      |
| 5 | TR 30 | 1    | 59S/TR30    |      |
| 3 | TR 30 | 1    | 59S/TR30-3P |      |
| 5 | TR 40 | 1    | 59S/TR40    |      |
| 3 | TR 40 | 1    | 59S/TR40-3P |      |

1/4" Standard Screwdriver Bits for Metric Hex Head Screws 25 mm



59S/H mm

| X   | Icon | Icon | Icon        | Icon |
|-----|------|------|-------------|------|
| 5   | 1.5  | 1    | 59S/H1.5    |      |
| 3   | 1.5  | 1    | 59S/H1.5-3P |      |
| 5   | 2    | 1    | 59S/H2      |      |
| 3   | 2    | 1    | 59S/H2-3P   |      |
| 5   | 2.5  | 1    | 59S/H2.5    |      |
| 3   | 2.5  | 1    | 59S/H2.5-3P |      |
| 5   | 3    | 1    | 59S/H3      |      |
| 3   | 3    | 1    | 59S/H3-3P   |      |
| 5   | 4    | 1    | 59S/H4      |      |
| 3   | 4    | 1    | 59S/H4-3P   |      |
| 500 | 4    | 500  | 59S/H4-IPB  |      |
| 5   | 5    | 1    | 59S/H5      |      |
| 3   | 5    | 1    | 59S/H5-3P   |      |
| 5   | 6    | 1    | 59S/H6      |      |
| 3   | 6    | 1    | 59S/H6-3P   |      |
| 3   | 8    | 1    | 59S/H8-3P   |      |
| 5   |      | 1    | 59S/H8-5P   |      |
| 5   | 10   | 1    | 59S/H10     |      |
| 3   | 10   | 1    | 59S/H10-3P  |      |



1/4" Standard Screwdriver Bits for Imperial Hex Head Screws 25 mm



59S/H "

| Quantity | Size    | Part Number    |
|----------|---------|----------------|
| 3        | 1/16 in | 1 59S/H1/16-3P |
| 5        | 5/16 in | 1 59S/H5/16-5P |
| 3        | 5/64 in | 1 59S/H5/64-3P |
| 5        | 5/64 in | 1 59S/H5/64-5P |
| 3        | 3/32 in | 1 59S/H3/32-3P |
| 5        | 3/32 in | 1 59S/H3/32-5P |
| 3        | 7/64 in | 1 59S/H7/64-3P |
| 5        |         | 1 59S/H7/64-5P |
| 3        | 1/8 in  | 1 59S/H1/8-3P  |
| 5        | 1/8 in  | 1 59S/H1/8-5P  |
| 3        | 9/64 in | 1 59S/H9/64-3P |
| 3        | 5/32 in | 1 59S/H5/32-3P |
| 5        | 5/32 in | 1 59S/H5/32-5P |
| 3        | 3/16 in | 1 59S/H3/16-3P |
| 5        | 3/16 in | 1 59S/H3/16-5P |
| 3        | 7/32 in | 1 59S/H7/32-3P |
| 5        | 7/32 in | 1 59S/H7/32-5P |
| 3        | 1/4 in  | 1 59S/H1/4-3P  |
| 5        | 1/4 in  | 1 59S/H1/4-5P  |
| 3        | 5/16 in | 1 59S/H5/16-3P |
| 3        | 3/8 in  | 1 59S/H3/8-3P  |
| 5        | 3/8 in  | 1 59S/H3/8-5P  |

1/4" Standard Screwdriver Bits for Robertson Head Screws 25 mm



59S/R

| Quantity | Size | Part Number |
|----------|------|-------------|
| 10       | # 1  | 1 59S/R1    |
| 3        | # 1  | 1 59S/R1-3P |
| 10       | # 2  | 1 59S/R2    |
| 3        | # 2  | 1 59S/R2-3P |
| 10       | # 3  | 1 59S/R3    |
| 3        | # 3  | 1 59S/R3-3P |
| 10       | # 4  | 1 59S/R4    |

1/4" Standard Screwdriver Bits for TORQ-SET Security Head Screws 25 mm - 5 Pcs/ Plastic Box



59S/TS

| Quantity | Size | Part Number    |
|----------|------|----------------|
| 5        | 0    | 1 59S/TS-0     |
| 5        | 1    | 1 59S/TS-1     |
| 5        | 2    | 1 59S/TS-2     |
| 5        | 3    | 1 59S/TS-3     |
| 5        | 4    | 1 59S/TS-4-5P  |
| 5        | 5    | 1 59S/TS-5-5P  |
| 5        | 6    | 1 59S/TS-6-5P  |
| 5        | 8    | 1 59S/TS-8-5P  |
| 5        | 10   | 1 59S/TS-10-5P |

1/4" Imperial Standard Screwdriver Bits for TORQ-SET® Head Screws 25 mm



59S/TS "

| Quantity | Size | Part Number  |
|----------|------|--------------|
| 5        | 1/4" | 1 59S/TS-1/4 |

1/4" Standard Screwdriver Bits for Tri-Wing Head Screws 25 mm - 5 Pcs/Plastic Box



59S/TW

| Quantity | Size | Part Number |
|----------|------|-------------|
| 5        | TW 0 | 1 59S/TW0   |
| 5        | TW 1 | 1 59S/TW1   |
| 5        | TW 2 | 1 59S/TW2   |
| 5        | TW 3 | 1 59S/TW3   |
| 5        | TW 4 | 1 59S/TW4   |
| 5        | TW 5 | 1 59S/TW5   |

1/4" Standard Screwdriver Bits for XZN Head Screws 25 mm



59S/M

| Quantity | Size | Part Number |
|----------|------|-------------|
| 10       | M3   | 1 59S/M3    |
| 3        | M3   | 1 59S/M3-3P |
| 10       | M4   | 1 59S/M4    |
| 3        | M4   | 1 59S/M4-3P |
| 10       | M5   | 1 59S/M5    |
| 3        | M5   | 1 59S/M5-3P |
| 10       | M6   | 1 59S/M6    |
| 3        | M6   | 1 59S/M6-3P |
| 10       | M8   | 1 59S/M8    |
| 3        | M8   | 1 59S/M8-3P |

1/4" Standard Screwdriver Bits for Slotted Head Screws 50 mm



59S/50

| Quantity | Size   | Part Number      |
|----------|--------|------------------|
| 5        | 3.5 mm | 1 59S/50/0.6-3.5 |
| 5        | 4.0 mm | 1 59S/50/0.8-4.0 |
| 5        | 5.5 mm | 1 59S/50/0.8-5.5 |
| 5        | 6.0 mm | 1 59S/50/1.0-6.0 |
| 5        | 6.5 mm | 1 59S/50/1.2-6.5 |
| 2        | 3.5 mm | 1 59S/50/3.5-2P  |
| 2        | 4.0 mm | 1 59S/50/4.0-2P  |
| 2        | 5.5 mm | 1 59S/50/5.5-2P  |
| 2        | 6.0 mm | 1 59S/50/6.0-2P  |
| 2        | 6.5 mm | 1 59S/50/6.5-2P  |

1/4" Standard Screwdriver Bits for Phillips Head Screws 50 mm



59S/50PH

| Quantity | Size | Part Number    |
|----------|------|----------------|
| 5        | 1    | 1 59S/50PH1    |
| 2        | 1    | 1 59S/50PH1-2P |
| 5        | 2    | 1 59S/50PH2-5P |
| 2        | 2    | 1 59S/50PH2-2P |
| 2        | 3    | 1 59S/50PH3-2P |
| 5        | 3    | 1 59S/50PH3-5P |

1/4" Standard Screwdriver Bits for Pozidriv Head Screws 50 mm



**59S/50PZ**

| X | + |   |              |
|---|---|---|--------------|
| 2 | 1 | 1 | 59S/50PZ1-2P |
| 2 | 2 | 1 | 59S/50PZ2-2P |
| 5 | 2 | 1 | 59S/50PZ2-5P |
| 2 | 3 | 1 | 59S/50PZ3-2P |
| 5 | 3 | 1 | 59S/50PZ3-5P |

1/4" Standard Screwdriver Bits for TORX® Head Screws 50 mm



**59S/50T**

| X | T    |   |              |
|---|------|---|--------------|
| 5 | T 8  | 1 | 59S/50T8     |
| 2 | T8   | 1 | 59S/50T8-2P  |
| 5 | T 10 | 1 | 59S/50T10    |
| 2 | T10  | 1 | 59S/50T10-2P |
| 5 | T 15 | 1 | 59S/50T15    |
| 2 | T15  | 1 | 59S/50T15-2P |
| 5 | T 20 | 1 | 59S/50T20-5P |
| 2 | T20  | 1 | 59S/50T20-2P |
| 5 | T 25 | 1 | 59S/50T25    |
| 2 | T25  | 1 | 59S/50T25-2P |
| 5 | T 27 | 1 | 59S/50T27    |
| 5 | T 30 | 1 | 59S/50T30    |
| 2 | T30  | 1 | 59S/50T30-2P |
| 5 | T 40 | 1 | 59S/50T40    |
| 2 | T40  | 1 | 59S/50T40-2P |

1/4" Standard Screwdriver Bits for Metric Hex Head Screws 50 mm



**59S/50H**

| X | Hex |   |               |
|---|-----|---|---------------|
| 5 | 2   | 1 | 59S/50H2      |
| 2 | 2   | 1 | 59S/50H2-2P   |
| 5 | 2.5 | 1 | 59S/50H2.5-5P |
| 2 | 2.5 | 1 | 59S/50H2.5-2P |

| X | Hex |   |             |
|---|-----|---|-------------|
| 5 | 3   | 1 | 59S/50H3    |
| 2 | 3   | 1 | 59S/50H3-2P |
| 5 | 4   | 1 | 59S/50H4-5P |
| 2 | 4   | 1 | 59S/50H4-2P |
| 5 | 5   | 1 | 59S/50H5-5P |
| 2 | 5   | 1 | 59S/50H5-2P |
| 5 | 6   | 1 | 59S/50H6    |
| 2 | 6   | 1 | 59S/50H6-2P |
| 2 | 8   | 1 | 59S/50H8-2P |
| 5 | 8   | 1 | 59S/50H8-5P |

1/4" Standard Screwdriver Bits for Imperial Hex Head Screws 50 mm



**59S/50H "**

| X | Hex     |   |             |
|---|---------|---|-------------|
| 5 | 1/1 in  | 1 | 59S/50H1/16 |
| 5 | 5/64 in | 1 | 59S/50H5/64 |
| 5 | 3/32 in | 1 | 59S/50H3/32 |
| 5 | 7/64 in | 1 | 59S/50H7/64 |
| 5 | 1/8 in  | 1 | 59S/50H1/8  |
| 5 | 9/64 in | 1 | 59S/50H9/64 |
| 5 | 5/32 in | 1 | 59S/50H5/32 |
| 5 | 3/16 in | 1 | 59S/50H3/16 |
| 5 | 7/32 in | 1 | 59S/50H7/32 |
| 5 | 1/4 in  | 1 | 59S/50H1/4  |
| 5 | 5/16 in | 1 | 59S/50H5/16 |
| 5 | 3/8 in  | 1 | 59S/50H3/8  |

1/4" Standard Screwdriver Bits for Robertson Head Screws 50 mm



**59S/50R**

| X | Robertson |   |             |
|---|-----------|---|-------------|
| 5 | #1        | 1 | 59S/50R1    |
| 2 | #1        | 1 | 59S/50R1-2P |
| 5 | #2        | 1 | 59S/50R2    |
| 2 | #2        | 1 | 59S/50R2-2P |
| 5 | #3        | 1 | 59S/50R3    |
| 2 | #3        | 1 | 59S/50R3-2P |

1/4" Standard Screwdriver Bits for Phillips Head Screws 70 mm



**59S/70PH**

| X | + |   |              |
|---|---|---|--------------|
| 2 | 1 | 1 | 59S/70PH1-2P |
| 2 | 2 | 1 | 59S/70PH2-2P |
| 5 | 2 | 1 | 59S/70PH2-5P |

1/4" Standard Screwdriver Bits for Pozidriv Head Screws 70 mm



**59S/70PZ**

| X | + |   |              |
|---|---|---|--------------|
| 5 | 1 | 1 | 59S/70PZ1    |
| 2 | 1 | 1 | 59S/70PZ1-2P |
| 5 | 2 | 1 | 59S/70PZ2    |
| 2 | 2 | 1 | 59S/70PZ2-2P |
| 5 | 3 | 1 | 59S/70PZ3    |
| 2 | 3 | 1 | 59S/70PZ3-2P |

1/4" Standard Screwdriver Bits for TORX® Head Screws 70 mm



**59S/70T**

| X | T   |   |              |
|---|-----|---|--------------|
| 5 | T10 | 1 | 59S/70T10    |
| 2 | T10 | 1 | 59S/70T10-2P |
| 5 | T15 | 1 | 59S/70T15    |
| 2 | T15 | 1 | 59S/70T15-2P |
| 2 | T20 | 1 | 59S/70T20-2P |
| 5 | T20 | 1 | 59S/70T20-5P |
| 2 | T25 | 1 | 59S/70T25-2P |
| 5 | T25 | 1 | 59S/70T25-5P |
| 5 | T27 | 1 | 59S/70T27    |
| 2 | T27 | 1 | 59S/70T27-2P |
| 2 | T30 | 1 | 59S/70T30-2P |
| 5 | T30 | 1 | 59S/70T30-5P |
| 5 | T40 | 1 | 59S/70T40    |
| 2 | T40 | 1 | 59S/70T40-2P |



1/4" Standard Screwdriver Bits for TORX®  
Tamper-Resistant Screws 70 mm



**59S/70TR**

| Quantity | Bit Type | Quantity | Part Number   |
|----------|----------|----------|---------------|
| 5        | TR15     | 1        | 59S/70TR15    |
| 2        | TR15     | 1        | 59S/70TR15-2P |
| 5        | TR20     | 1        | 59S/70TR20    |
| 2        | TR20     | 1        | 59S/70TR20-2P |
| 5        | TR25     | 1        | 59S/70TR25    |
| 2        | TR25     | 1        | 59S/70TR25-2P |
| 5        | TR27     | 1        | 59S/70TR27    |
| 2        | TR27     | 1        | 59S/70TR27-2P |
| 5        | TR30     | 1        | 59S/70TR30    |
| 2        | TR30     | 1        | 59S/70TR30-2P |
| 5        | TR40     | 1        | 59S/70TR40    |
| 2        | TR40     | 1        | 59S/70TR40-2P |

1/4" Standard Screwdriver Bits for Phillips  
Head Screws 125 mm



**59S/125PH**

| Quantity | Bit Type | Quantity | Part Number   |
|----------|----------|----------|---------------|
| 5        | PH1      | 1        | 59S/125PH1    |
| 2        | PH1      | 1        | 59S/125PH1-2P |
| 5        | PH2      | 1        | 59S/125PH2    |
| 2        | PH2      | 1        | 59S/125PH2-2P |
| 100      | PH2-IP   | 100      | 59S/125PH2-IP |
| 2        | PH3      | 1        | 59S/125PH3-2P |
| 5        | PH3      | 1        | 59S/125PH3    |

1/4" Standard Screwdriver Bits for Pozidriv  
Head Screws 125 mm



**59S/125PZ**

| Quantity | Bit Type | Quantity | Part Number   |
|----------|----------|----------|---------------|
| 5        | PZ1      | 1        | 59S/125PZ1    |
| 2        | PZ1      | 1        | 59S/125PZ1-2P |
| 5        | PZ2      | 1        | 59S/125PZ2    |
| 2        | PZ2      | 1        | 59S/125PZ2-2P |
| 5        | PZ3      | 1        | 59S/125PZ3    |
| 2        | PZ3      | 1        | 59S/125PZ3-2P |

1/4" Standard Screwdriver Bits for Hex  
with Ball Point Screws 89 mm



**59S/H BALL**

| Quantity | Bit Size | Quantity | Part Number   |
|----------|----------|----------|---------------|
| 5        | 3        | 1        | 59S/H3BALL    |
| 2        | 3        | 1        | 59S/H3BALL-2P |
| 5        | 4        | 1        | 59S/H4BALL    |
| 2        | 4        | 1        | 59S/H4BALL-2P |
| 5        | 5        | 1        | 59S/H5BALL    |
| 2        | 5        | 1        | 59S/H5BALL-2P |
| 5        | 6        | 1        | 59S/H6BALL    |
| 2        | 6        | 1        | 59S/H6BALL-2P |
| 5        | 8        | 1        | 59S/H8BALL    |
| 2        | 8        | 1        | 59S/H8BALL-2P |
| 3        | 5,6,8    | 1        | 59S/HBALL-3P  |

1/4" Standard Screwdriver Bits for Plus-  
Minus/Phillips Head Screws 125 mm



**59S/PH COMBI**

| Quantity | Bit Type | Quantity | Part Number     |
|----------|----------|----------|-----------------|
| 2        | 5.0/PH1  | 1        | 59S/PH1COMBI-2P |
| 2        | 6.0/PH2  | 1        | 59S/PH2COMBI-2P |
| 2        | 8.0/PH3  | 1        | 59S/PH3COMBI-2P |

1/4" Standard Screwdriver Bits for TORX®  
Head Screws 150 mm



**59S/150T**

| Quantity | Bit Type | Quantity | Part Number   |
|----------|----------|----------|---------------|
| 5        | T15      | 1        | 59S/150T15    |
| 2        | T15      | 1        | 59S/150T15-2P |
| 5        | T20      | 1        | 59S/150T20    |
| 2        | T20      | 1        | 59S/150T20-2P |
| 5        | T25      | 1        | 59S/150T25    |
| 2        | T25      | 1        | 59S/150T25-2P |
| 5        | T30      | 1        | 59S/150T30    |
| 2        | T30      | 1        | 59S/150T30-2P |

7/16" Screwdriver Bits for Hex Head  
Screws 35 mm



**74S/H**

| Quantity | Bit Size | Quantity | Part Number |
|----------|----------|----------|-------------|
| 5        | 4 mm     | 1        | 74S/H4      |
| 2        | 4 mm     | 1        | 74S/H4-2P   |
| 5        | 5 mm     | 1        | 74S/H5      |
| 2        | 5 mm     | 1        | 74S/H5-2P   |
| 5        | 6 mm     | 1        | 74S/H6      |
| 2        | 6 mm     | 1        | 74S/H6-2P   |
| 5        | 7 mm     | 1        | 74S/H7      |
| 2        | 7 mm     | 1        | 74S/H7-2P   |
| 5        | 8 mm     | 1        | 74S/H8      |
| 2        | 8 mm     | 1        | 74S/H8-2P   |
| 5        | 10 mm    | 1        | 74S/H10     |
| 2        | 10 mm    | 1        | 74S/H10-2P  |
| 5        | 12 mm    | 1        | 74S/H12     |
| 2        | 12 mm    | 1        | 74S/H12-2P  |
| 5        | 14 mm    | 1        | 74S/H14     |
| 2        | 14 mm    | 1        | 74S/H14-2P  |
| 5        | 17 mm    | 1        | 74S/H17     |
| 2        | 17 mm    | 1        | 74S/H17-2P  |

5/32" Standard Screwdriver Bits for Phillips Head Screws 25 mm



**45S/PH**

|   |   |   |            |
|---|---|---|------------|
|   |   |   |            |
| 5 | 1 | 1 | 45S/PH1    |
| 2 | 1 | 1 | 45S/PH1-2P |
| 5 | 2 | 1 | 45S/PH2    |
| 2 | 2 | 1 | 45S/PH2-2P |

5/32" Standard Screwdriver Bits for Hex Head Screws 25 mm



**45S/H**

|   |        |   |             |
|---|--------|---|-------------|
|   |        |   |             |
| 5 | 1.5 mm | 1 | 45S/H1.5    |
| 2 | 1.5 mm | 1 | 45S/H1.5-2P |
| 5 | 2 mm   | 1 | 45S/H2      |
| 2 | 2 mm   | 1 | 45S/H2-2P   |
| 5 | 2.5 mm | 1 | 45S/H2.5    |
| 2 | 2.5 mm | 1 | 45S/H2.5-2P |
| 5 | 3 mm   | 1 | 45S/H3      |
| 2 | 3 mm   | 1 | 45S/H3-2P   |

1/4" Bit Set for Phillips/Pozidriv/TORX® Head Screws - 7 Pcs



**59S/7-1**

|   |                 |   |         |
|---|-----------------|---|---------|
|   |                 |   |         |
| 7 | 22 x 65 x 75 mm | 1 | 59S/7-1 |

|                  |  |  |
|------------------|--|--|
| 59S/PH1, 59S/PH2 |  |  |
| 59S/PZ1, 59S/PZ2 |  |  |
| 59S/T15, 59S/T20 |  |  |

1/4" Bit Set for Phillips/TORX® Head Screws - 7 Pcs



**59S/7-2**

|   |                 |   |         |
|---|-----------------|---|---------|
|   |                 |   |         |
| 7 | 22 x 65 x 75 mm | 1 | 59S/7-2 |

|                                 |  |  |
|---------------------------------|--|--|
| 59S/PH2                         |  |  |
| 59S/T15x 2, 59S/T20x 2, 59S/T25 |  |  |

1/4" Bit Set for TORX® Tamper Resistant Screws - 7 Pcs



**59S/7-3**

|   |                 |   |         |
|---|-----------------|---|---------|
|   |                 |   |         |
| 7 | 22 x 65 x 75 mm | 1 | 59S/7-3 |

|  |  |  |
|--|--|--|
| 59S/TR10, 59S/TR15, 59S/TR20, 59S/TR25, 59S/TR30, 59S/TR40 |  |  |
|--|--|--|

1/4" Bit Set for TORX® Head Screws - 7 Pcs



**59S/7-4**

|   |                 |   |         |
|---|-----------------|---|---------|
|   |                 |   |         |
| 7 | 22 x 65 x 75 mm | 1 | 59S/7-4 |

|  |  |  |
|--|--|--|
| 59S/T10, 59S/T15, 59S/T20, 59S/T25, 59S/T30, 59S/T40 |  |  |
|--|--|--|

1/4" Bit Set for Phillips/Pozidriv/Torx® Head Screws in a Plastic Holder with Belt Clip - 10 pcs



**59S/10BC**

|    |                  |   |          |
|----|------------------|---|----------|
|    |                  |   |          |
| 10 | 23 x 68 x 168 mm | 1 | 59S/10BC |

1/4" Conical Bit Set for Torx® Head Screws - 11 pcs



**59S/TCS11-1**

|    |                  |   |             |
|----|------------------|---|-------------|
|    |                  |   |             |
| 11 | 108 x 68 x 31 mm | 1 | 59S/TCS11-1 |

|   |  |  |
|---|--|--|
| 59S/T10CS, 59S/T15CS, 59S/T20CSx 3, 59S/T25CSx 2, 59S/T30CSx 2, 59S/T40CS |  |  |
| KM653-QR-1P   |  |  |

1/4" Bit Set for Slotted/Phillips/Pozidriv/Hex Head Screws - 17 Pcs



**59S/17-1**

|    |                 |   |          |
|----|-----------------|---|----------|
|    |                 |   |          |
| 17 | 27 x 73 x 82 mm | 1 | 59S/17-1 |

|                                       |  |  |
|---------------------------------------|--|--|
| 59S/0.5-3.0, 59S/0.6-4.5, 59S/0.8-5.5 |  |  |
| 59S/PH1, 59S/PH2x 3                   |  |  |
| 59S/PH2Gx 2                           |  |  |
| 59S/PZ1, 59S/PZ2x 2                   |  |  |
| 59S/H3, 59S/H4, 59S/H5, 59S/H6        |  |  |





1/4" Bit Set for TORX® Head Screws - 17 Pcs



**59S/17-2**

|    |                 |   |          |
|----|-----------------|---|----------|
|    |                 |   |          |
| 17 | 27 x 73 x 82 mm | 1 | 59S/17-2 |

59S/T7, 59S/T8, 59S/T9, 59S/T10, 59S/T15x 2, 59S/T20x 3, 59S/T25x 3, 59S/T27, 59S/T30x 2, 59S/T40

1/4" Bit Set for Phillips/ Pozidriv/TORX®/ Hex Head Screws - 17 Pcs



**59S/17-3**

|    |                 |   |          |
|----|-----------------|---|----------|
|    |                 |   |          |
| 17 | 27 x 73 x 82 mm | 1 | 59S/17-3 |

59S/PH1, 59S/PH2x 2  
59S/PZ1, 59S/PZ2, 59S/PZ3  
59S/T10, 59S/T15, 59S/T20, 59S/T25, 59S/T27, 59S/T30, 59S/T40  
59S/H3, 59S/H4, 59S/H5

1/4" bit set for Slotted/Phillips/Pozidriv/TORX® Head Screw - 22 Pcs



**59S/22-1**

|    |                 |   |          |
|----|-----------------|---|----------|
|    |                 |   |          |
| 22 | 20 x 50 x 80 mm | 1 | 59S/22-1 |

|   |  |
|---|--|
| 59S/0.5-3.0, 59S/0.6-4.5, 59S/0.8-5.5   |  |
| 59S/PH1, 59S/PH2, 59S/PH3   |  |
| 59S/PH2G  |  |
| 59S/PZ1, 59S/PZ2, 59S/PZ3   |  |
| 59S/T6, 59S/T8, 59S/T9, 59S/T10, 59S/T15, 59S/T20, 59S/T25, 59S/T27, 59S/T30, 59S/T40 |  |
| K6650-1/4   |  |

1/4" bit set for Phillips/ Hex/ TORX® Head Screw - 22 Pcs



**59S/22-2**

|    |                 |   |          |
|----|-----------------|---|----------|
|    |                 |   |          |
| 22 | 20 x 50 x 80 mm | 1 | 59S/22-2 |

|   |  |
|---|--|
| 59S/PH2x 3                                  |  |
| 59S/PH2Gx 3                                 |  |
| 59S/PZ2x 2                                  |  |
| 59S/T10, 59S/T15x 4, 59S/T20x 3, 59S/T25x 2 |  |
| 59S/H2.5, 59S/H3                            |  |
| K6650-1/4                                   |  |

1/4" Bit set for Slotted/ Phillips/ TORX®/ Hex/ TORQ-SET head screw - 28 Pcs



**59S/28**

|    |                  |   |          |
|----|------------------|---|----------|
|    |                  |   |          |
| 28 | 30 x 58 x 110 mm | 1 | 59S/28-4 |

|   |  |
|---|--|
| 59S/0.6-4.5, 59S/1.2-6.5, 59S/1.2-8.0   |  |
| 59S/PH1x 2, 59S/PH2x 2, 59S/PH3   |  |
| 59S/T6, 59S/T15   |  |
| 59S/H5/64, 59S/H3/32, 59S/H7/64, 59S/H1/8, 59S/H5/32, 59S/H3/16, 59S/H7/32, 59S/TS-4x 2, 59S/TS-6x 2, 59S/TS-8x 2, 59S/TS-10x 2, K6625-1/4, KM653 |  |
| 59S/H9/64   |  |

1/4" Bit Set for Slotted/Phillips/Pozidriv/TORX®/Hex Head Screw - 31 Pcs



**59S/31B**

|    |                           |   |         |
|----|---------------------------|---|---------|
|    |                           |   |         |
| 31 | 40.25 x 104.90 x 65.35 mm | 1 | 59S/31B |

|   |  |
|---|--|
| 59S/0.6-4.5, 59S/1.0-5.5                                      |  |
| 59S/PH1, 59S/PH2x 3, 59S/PH3                                  |  |
| 59S/PH2Gx 2   |  |
| 59S/PZ1, 59S/PZ2x 3, 59S/PZ3                                  |  |
| 59S/T10, 59S/T15x 3, 59S/T20x 3, 59S/T25x 2, 59S/T27, 59S/T30 |  |
| 59S/H3, 59S/H4, 59S/H5, 59S/H6                                |  |
| K6625-1/4-1P  |  |
| KM653-QR-1P   |  |

1/4" Bit Set for Slotted/Phillips/Pozidriv/TORX®/Hex Head Screw - 31 Pcs/12 Pcs Carton Display



**59S/31B-IP**

|    |                    |    |            |
|----|--------------------|----|------------|
|    |                    |    |            |
| 12 | 280 x 375 x 210 mm | 12 | 59S/31B-IP |

Order 12 pieces of the ref. 59S/31B-IP to receive 1 display

1/4" bit set for Slotted/ Phillips/ Pozidriv/ Hex/ TORX® screw - 31 Pcs



**59S/31-1**

|    |                  |   |          |
|----|------------------|---|----------|
|    |                  |   |          |
| 31 | 42 x 65 x 110 mm | 1 | 59S/31-1 |

|   |  |  |
|---|--|--|
| 59S/0.5-3.0, 59S/0.6-4.5, 59S/0.8-5.5                         |  |  |
| 59S/PH1, 59S/PH2x 3, 59S/PH3                                  |  |  |
| 59S/PH2Gx 2   |  |  |
| 59S/PZ1, 59S/PZ2x 3, 59S/PZ3                                  |  |  |
| 59S/T10, 59S/T15x 3, 59S/T20x 3, 59S/T25x 2, 59S/T27, 59S/T30 |  |  |
| 59S/H3, 59S/H4, 59S/H5, 59S/H6                                |  |  |
| 66IM/KM75QR-1P  |  |  |

1/4" Bit Set for Phillips/Pozidriv/TORX® Screws - 31 Pcs



**59S/31-2**

|    |                  |   |          |
|----|------------------|---|----------|
|    |                  |   |          |
| 31 | 42 x 65 x 110 mm | 1 | 59S/31-2 |

|  |  |  |
|--|--|--|
| 59S/PH2x 4   |  |  |
| 59S/PH2Gx 4  |  |  |
| 59S/PZ2x 4   |  |  |
| 59S/T10x 2, 59S/T15x 4, 59S/T20x 5, 59S/T25x 5, 59S/T30x 2 |  |  |
| KM653-QR-1P  |  |  |

1/4" Bit Set for Phillips/Pozidriv/TORX® Tamper Resistant Screws - 31 Pcs



**59S/31-3**

|    |                  |   |          |
|----|------------------|---|----------|
|    |                  |   |          |
| 31 | 42 x 65 x 110 mm | 1 | 59S/31-3 |

|   |  |  |
|---|--|--|
| 59S/PH1x 2, 59S/PH2x 2, 59S/PH3   |  |  |
| 59S/PZ1x 2, 59S/PZ2x 2, 59S/PZ3   |  |  |
| 59S/TR10x 2, 59S/TR15x 3, 59S/TR20x 5, 59S/TR25x 4, 59S/TR27, 59S/TR30x 4, 59S/TR40 |  |  |
| KM653-QR-1P   |  |  |

1/4" bit set for Phillips/ Pozidriv/ Hex/ TORX® head screw - 35 Pcs



**59/S35BC**

|    |                   |   |          |
|----|-------------------|---|----------|
|    |                   |   |          |
| 35 | 50 x 110 x 180 mm | 1 | 59/S35BC |

1/4" Bit Set for Slotted/Phillips/Pozidriv/ Hex/TORX®/TORX® Tamper/Robertson Screw - 54 Pcs



**59/S54BC**

|    |                   |   |          |
|----|-------------------|---|----------|
|    |                   |   |          |
| 54 | 50 x 110 x 184 mm | 1 | 59/S54BC |

TORX bits are colored to easy identify the size of the tip

1/4" Bit Set for Slotted/Phillips/Pozidriv/ Hex/TORX®/TORX® Tamper/Robertson Screw - 54 Pcs/8 Pcs Carton Display



**59/S54BC-IP**

|    |                    |   |             |
|----|--------------------|---|-------------|
|    |                    |   |             |
| 54 | 300 x 190 x 280 mm | 8 | 59/S54BC-IP |

Order 8 pieces of the re. 59/S54BC-IP to receive 1 display TORX bits are colored to easy identify the size of the tip

1/4" Bit Set for Slotted/Phillips/Pozidriv/ Hex/ TORX®/TORX® Tamper/Robertson Screw - 100 Pcs



**59/S100BC**

|     |                   |   |           |
|-----|-------------------|---|-----------|
|     |                   |   |           |
| 100 | 50 x 110 x 184 mm | 1 | 59/S100BC |

TORX bits are colored

1/4" Bit Set for Slotted/Phillips/Pozidriv/ Hex/ TORX®/TORX® Tamper/Robertson Screw - 100 Pcs/8 Pcs Carton Display



**59/S100BC-IP**

|     |                    |   |              |
|-----|--------------------|---|--------------|
|     |                    |   |              |
| 100 | 300 x 190 x 280 mm | 8 | 59/S100BC-IP |

Order 8 pieces of the re. 59/S100BC-IP to receive 1 display TORX bits are colored to easy identify the size of the tip



1/4" Standard Bit and Socket Set for Slotted/Phillips/Pozidriv/TORX®/Hex Head Screw - 26 Pcs



**2058/S26**

|    |                  |               |
|----|------------------|---------------|
|    |                  |               |
| 26 | 80 x 100 x 35 mm | 1 2058/S26    |
| 26 | 35 x 85 x 105 mm | 1 SB-2058/S26 |

SB: Retail pack on a plastic info card

|   |  |
|---|--|
| <b>2058-BR</b>  |  |
| <b>K6625-1/4-1P</b>                                       |  |
| <b>59S/H6, 59S/H5, 59S/H4, 59S/H3</b>                     |  |
| <b>59S/T15, 59S/T10, 59S/T30, 59S/T25, 59S/T20</b>        |  |
| <b>59S/PZ3, 59S/PZ1, 59S/PZ2</b>                          |  |
| <b>59S/PH1, 59S/PH2, 59S/PH3</b>                          |  |
| <b>59S/0.8-5.5, 59S/0.5-4.0</b>                           |  |
| <b>6700SM-8, 6700SM-7, 6700SM-6, 6700SM-13, 6700SM-10</b> |  |
| <b>59S/1.0-6.0-1P</b>                                     |  |
| <b>KM753-QR-1P</b>  |  |

1/4" Standard Bit and Socket Set for Slotted/Phillips/Pozidriv/TORX®/Hex Head Screw - 26 Pcs



**2058/S26AF**

|    |                  |              |
|----|------------------|--------------|
|    |                  |              |
| 26 | 80 x 100 x 35 mm | 1 2058/S26AF |

1/4" Small Bit and Socket Set for Slotted/Phillips/Pozidriv/TORX®/Hex Head Screw - 26 Pcs



**2058/S26-2**

|                  |   |            |
|------------------|---|------------|
|                  |   |            |
| 80 x 100 x 35 mm | 1 | 2058/S26-2 |

|   |  |
|---|--|
| <b>2058-BR</b>  |  |
| <b>6700SM-8, 6700SM-7, 6700SM-6, 6700SM-5, 6700SM-4</b> |  |
| <b>K6625-1/4B-1P, KM653-QR-1P</b>                       |  |
| <b>59S/0.5-3.0, 59S/0.8-5.5, 59S/0.5-4.0</b>            |  |
| <b>59S/T8, 59S/T7, 59S/T6, 59S/T5, 59S/T4</b>           |  |
| <b>59S/PZ1, 59S/PZ0, 59S/PZ2</b>                        |  |
| <b>59S/H2, 59S/H2.5, 59S/H1.5, 59S/H3</b>               |  |
| <b>59S/PH1, 59S/PH0, 59S/PH2</b>                        |  |

1/4" Standard Screwdriver Bit Set for PH2 Head Screws 25 mm - 5 Pcs



|   |                  |              |
|---|------------------|--------------|
|   |                  |              |
| 5 | 13 x 17 x 132 mm | 1 59S/PH2PEN |

1/4" Standard Screwdriver Bit Set for PZ2 Head Screws 25 mm - 5 Pcs



|   |                  |              |
|---|------------------|--------------|
|   |                  |              |
| 5 | 13 x 17 x 132 mm | 1 59S/PZ2PEN |

1/4" Standard Screwdriver Bit Set for Torx® Screws 25 mm - 5 Pcs



|   |                  |              |
|---|------------------|--------------|
|   |                  |              |
| 5 | 13 x 17 x 132 mm | 1 59S/T15PEN |
| 5 | 13 x 17 x 132 mm | 1 59S/T20PEN |
| 5 | 13 x 17 x 132 mm | 1 59S/T25PEN |

1/4" Bit Pocket Set for Phillips/Pozidriv/Torx® Head Screws - 60 Pcs/Counter Display



|    |                    |                  |
|----|--------------------|------------------|
|    |                    |                  |
| 60 | 140 x 125 x 215 mm | 1 59S/60PEN/DISP |

|   |  |
|---|--|
| <b>59S/T15PENx 5, 59S/T20PENx 30, 59S/T25PENx 5</b> |  |
| <b>59S/PH2PENx 10</b>                               |  |
| <b>59S/PZ2PENx 10</b>                               |  |

5/16" Screwdriver Bits for Slotted Head Screws 41 mm



|   |         |                   |
|---|---------|-------------------|
|   |         |                   |
| 2 | 8.0 mm  | 1 70S/1.2-8.0-2P  |
| 5 | 9.0 mm  | 1 70S/1.6-9.0     |
| 2 | 9.0 mm  | 1 70S/1.6-9.0-2P  |
| 5 | 10.0 mm | 1 70S/1.6-10.0    |
| 2 | 10.0 mm | 1 70S/1.6-10.0-2P |



| 5 | 12.0 mm | 1 | 70S/2.0-12.0    |
|---|---------|---|-----------------|
| 2 | 12.0 mm | 1 | 70S/2.0-12.0-2P |
| 5 | 14.0 mm | 1 | 70S/2.5-14.0    |
| 2 | 14.0 mm | 1 | 70S/2.5-14.0-2P |

5/16" Screwdriver Bits for Phillips Head Screws 32 mm-38 mm



**70S/PH**



| 5 | 1 | 1 | 70S/PH1    |
|---|---|---|------------|
| 2 | 1 | 1 | 70S/PH1-2P |
| 5 | 2 | 1 | 70S/PH2    |
| 2 | 2 | 1 | 70S/PH2-2P |
| 5 | 3 | 1 | 70S/PH3    |
| 2 | 3 | 1 | 70S/PH3-2P |
| 5 | 4 | 1 | 70S/PH4    |
| 2 | 4 | 1 | 70S/PH4-2P |

5/16" Screwdriver Bits for Pozidriv Head Screws 32 mm-38 mm



**70S/PZ**



| 5 | 1 | 1 | 70S/PZ1    |
|---|---|---|------------|
| 2 | 1 | 1 | 70S/PZ1-2P |
| 5 | 2 | 1 | 70S/PZ2    |
| 2 | 2 | 1 | 70S/PZ2-2P |
| 5 | 3 | 1 | 70S/PZ3    |
| 2 | 3 | 1 | 70S/PZ3-2P |
| 5 | 4 | 1 | 70S/PZ4    |
| 2 | 4 | 1 | 70S/PZ4-2P |

5/16" Screwdriver Bits for TORX® Head Screws 35 mm



**70S/T**



| 5 | T25 | 1 | 70S/T25-5P |
|---|-----|---|------------|
| 5 | T20 | 1 | 70S/T20    |
| 2 | T20 | 1 | 70S/T20-2P |

| 2 | T25 | 1 | 70S/T25-2P |
|---|-----|---|------------|
| 5 | T27 | 1 | 70S/T27-5P |
| 2 | T27 | 1 | 70S/T27-2P |
| 5 | T30 | 1 | 70S/T30    |
| 2 | T30 | 1 | 70S/T30-2P |
| 2 | T40 | 1 | 70S/T40-2P |
| 5 | T45 | 1 | 70S/T45    |
| 2 | T45 | 1 | 70S/T45-2P |
| 5 | T50 | 1 | 70S/T50    |
| 2 | T50 | 1 | 70S/T50-2P |
| 5 | T55 | 1 | 70S/T55    |
| 2 | T55 | 1 | 70S/T55-2P |

5/16" Screwdriver Bits for TORQ-SET® Head Screws 32 mm



**70S/TS**



| 5 | 8 mm  | 1 | 70S/TS8     |
|---|-------|---|-------------|
| 2 | 8 mm  | 1 | 70S/TS8-2P  |
| 5 | 10 mm | 1 | 70S/TS10    |
| 2 | 10 mm | 1 | 70S/TS10-2P |

5/16" Imperial Screwdriver Bits for TORQ-SET® Head Screws 32 mm



**70S/TS"**



| 5 | 1/4"  | 1 | 70S/TS1/4     |
|---|-------|---|---------------|
| 2 | 1/4"  | 1 | 70S/TS1/4-2P  |
| 5 | 5/16" | 1 | 70S/TS5/16    |
| 2 | 5/16" | 1 | 70S/TS5/16-2P |

5/16" Screwdriver Bits for Hex Socket Head Screws 30 mm



**70S/H**



| 5 | 4 mm  | 1 | 70S/H4     |
|---|-------|---|------------|
| 2 | 4 mm  | 1 | 70S/H4-2P  |
| 5 | 5 mm  | 1 | 70S/H5     |
| 2 | 5 mm  | 1 | 70S/H5-2P  |
| 5 | 6 mm  | 1 | 70S/H6     |
| 2 | 6 mm  | 1 | 70S/H6-2P  |
| 5 | 7 mm  | 1 | 70S/H7     |
| 2 | 7 mm  | 1 | 70S/H7-2P  |
| 5 | 8 mm  | 1 | 70S/H8-5P  |
| 2 | 8 mm  | 1 | 70S/H8-2P  |
| 5 | 10 mm | 1 | 70S/H10    |
| 2 | 10 mm | 1 | 70S/H10-2P |
| 5 | 12 mm | 1 | 70S/H12    |
| 2 | 12 mm | 1 | 70S/H12-2P |
| 5 | 14 mm | 1 | 70S/H14    |
| 2 | 14 mm | 1 | 70S/H14-2P |

5/16" Hand Operated Impact Driver with 1/2" Square Drive 125 mm



**5521**

| 125 mm | 1 | 5521 |
|--------|---|------|

1/2" Square screwdriver adaptor for bits 5/16"



**54640**

| 40 mm | 1 | 54640 |
|-------|---|-------|



5/16" Bit Set for Slotted/ Phillips/Hex/ TORX® Head Screws - 23 Pcs



**7823**

|    |                  |        |
|----|------------------|--------|
|    |                  |        |
| 23 | 45 x 70 x 197 mm | 1 7823 |

5521

54640

70S/1.2-8.0, 70S/1.6-10.0, 70S/2.0-12.0

70S/PH2, 70S/PH3, 70S/PH4

70S/T20, 70S/T25, 70S/T27, 70S/T30, 70S/T40, 70S/T45, 70S/T50, 70S/T55

70S/H4, 70S/H5, 70S/H6, 70S/H7, 70S/H8, 70S/H10, 70S/H12, 70S/H14

5/16" Bit Set for Slotted/Phillips/Hex Head Screws - 14 Pcs



**7865**

|    |                  |        |
|----|------------------|--------|
|    |                  |        |
| 15 | 55 x 90 x 220 mm | 1 7865 |

Including 1 adapter, hexagon 5/16" to 3/8" square drive

5521

54640

70S/1.2-8.0, 70S/1.6-10.0

70S/PH1, 70S/PH2, 70S/PH3, 70S/PH4

70S/H4, 70S/H5, 70S/H6, 70S/H8

Threaded Screwdriver Bits for Phillips Head Screws



**K18**

|   |   |             |
|---|---|-------------|
|   |   |             |
| 1 | 2 | 1 K18NF-2   |
| 1 | 2 | 1 K18PH-2M5 |
| 1 | 2 | 1 K18PH-2M6 |

Threaded Screwdriver Bits for Pozidriv Head Screws



**K19PZD-2NF**

|   |   |              |
|---|---|--------------|
|   |   |              |
| 1 | 2 | 1 K19PZD-2NF |
| 1 | 2 | 1 K19PZD-2M5 |

Threaded Screwdriver Bits for TORX® Head Screws 44.5 mm



**K20TORX**

|   |     |               |
|---|-----|---------------|
|   |     |               |
| 1 | T25 | 1 K20TORX-T25 |

1/4" Hex Head Non-Magnetic Power Nut Drivers



**K6750**

|   |        |               |
|---|--------|---------------|
|   |        |               |
| 1 | 1/4 in | 1 K6750-6     |
| 1 | 1/4 in | 1 K6750-7     |
| 1 | 1/4 in | 1 K6750-10-1P |
| 1 | 1/4 in | 1 K6750-13    |
| 1 | 1/4 in | 1 K6750-1/4   |
| 1 | 1/4 in | 1 K6750-3/8   |

1/4" Hex Head Magnetic Power Nut Drivers



**KM6750**

|   |                |
|---|----------------|
|   |                |
| 1 | 1 KM6750-6     |
| 1 | 1 KM6750-7     |
| 1 | 1 KM6750-10-1P |
| 1 | 1 KM6750-11    |
| 1 | 1 KM6750-13-1P |
| 1 | 1 KM6750-1/4   |
| 1 | 1 KM6750-3/8   |

1/4" Hex Universal Magnetic Bit Holders with Quick Release 60 mm



**KM653-QR**

|   |      |               |
|---|------|---------------|
|   |      |               |
| 1 | 1/4" | 1 KM653-QR-1P |
| 5 | 1/4" | 1 KM653-QR-5P |



1/4" Hex Universal Magnetic Bit Holders with Quick Release 75 mm



**KM753-QR**

|   |        |   |             |
|---|--------|---|-------------|
|   |        |   |             |
| 1 | 1/4 in | 1 | KM753-QR-1P |

1/4" Heavy-Duty Torsion Screwdriver Bit Holders



**KMT753-QR-1P**

|        |        |   |              |  |  |
|--------|--------|---|--------------|--|--|
|        |        |   |              |  |  |
| 1/4 in | 1/4 in | 1 | KMT753-QR-1P |  |  |

1/4" Hex Universal Magnetic Bit Holders with Retaining Ring 75 mm



**KMR753**

|   |        |   |           |
|---|--------|---|-----------|
|   |        |   |           |
| 1 | 1/4 in | 1 | KMR753-1P |
| 5 | 1/4 in | 1 | KMR753    |

1/4" Hex Universal Bit Holders with Retaining Ring 60 mm



**KR653**

|   |        |   |          |
|---|--------|---|----------|
|   |        |   |          |
| 1 | 1/4 in | 1 | KR653-1P |
| 5 | 1/4 in | 1 | KR653    |

1/4" Hex Universal magnetic bit holder with Swivel Function 65 mm



**KM653-SF**

|   |         |   |          |
|---|---------|---|----------|
|   |         |   |          |
| 1 | 1/4" in | 1 | KM653-SF |

1/4" Hex Copper-Beryllium Universal bit holder with Retaining Ring 75 mm



**KCB753**

|   |        |   |        |
|---|--------|---|--------|
|   |        |   |        |
| 1 | 1/4 in | 1 | KCB753 |

1/4" Hex Universal Magnetic Bit Holders 60 mm



**KM653**

|   |      |   |          |
|---|------|---|----------|
|   |      |   |          |
| 1 | 1/4" | 1 | KM653-1P |
| 5 | 1/4" | 1 | KM653-5P |

1/4" Hex Universal Magnetic Bit Holders with Retaining Ring 60 mm



**KMR653**

|   |        |   |           |
|---|--------|---|-----------|
|   |        |   |           |
| 1 | 1/4 in | 1 | KMR653-1P |
| 5 | 1/4 in | 1 | KMR653-5P |

1/4" Hex Universal Magnetic Bit Holders with Retaining Ring 150 mm



**KMR150**

|   |        |   |           |
|---|--------|---|-----------|
|   |        |   |           |
| 1 | 1/4 in | 1 | KMR150-1P |
| 5 | 1/4 in | 1 | KMR150    |



1/4" Hex drive Universal Magnetic Bit Holder for 5/16" bits 70 mm



**KM1/4-5/16-1P**

|   |        |   |               |
|---|--------|---|---------------|
|   |        |   |               |
| 1 | 1/4 in | 1 | KM1/4-5/16-1P |

1/4" Hex Drive to 1/4" Socket adaptors 25 mm



**K6625**

|   |        |   |               |
|---|--------|---|---------------|
|   |        |   |               |
| 1 | 1/4 in | 1 | K6625-1/4-1P  |
| 5 |        | 1 | K6625-1/4B-5P |

1/4" Hex Drive to 3/8" Socket Adaptors 38 mm



**K6638**

|   |        |   |              |
|---|--------|---|--------------|
|   |        |   |              |
| 1 | 1/4 in | 1 | K6638-3/8-1P |
| 5 | 1/4 in | 1 | K6638-3/8    |

1/4" Hex Drive to 1/4", 3/8", 1/2" Socket Adaptors 50 mm



**K6650**

|   |        |   |               |
|---|--------|---|---------------|
|   |        |   |               |
| 1 |        | 1 | K6650-1/4B-1P |
| 5 |        | 1 | K6650-1/4P-5P |
| 1 | 1/4 in | 1 | K6650-3/8-1P  |
| 5 |        | 1 | K6650-3/8P-5P |
| 1 | 1/4 in | 1 | K6650-1/2-1P  |
| 5 |        | 1 | K6650-1/2P-5P |

1/4" Hex Drive to 1/4", 3/8" Socket Adaptors 100 mm



**K66100**

|   |        |   |               |
|---|--------|---|---------------|
|   |        |   |               |
| 1 | 1/4 in | 1 | K66100-1/4-1P |
| 5 | 1/4 in | 1 | K66100-1/4    |
| 1 | 1/4 in | 1 | K66100-3/8-1P |
| 5 | 1/4 in | 1 | K66100-3/8    |

1/4" Hex Drive to 1/4" Socket Adaptor with Quick Release 60 mm



**K6660-QR**

|   |        |   |             |
|---|--------|---|-------------|
|   |        |   |             |
| 1 | 1/4 in | 1 | K6660-QR-1P |

**IMPACT TOOLS**

1/4" Square Drive Impact Sockets with Metric Hex Profile and Phosphate Finish



**K6701M**

|       |   |           |
|-------|---|-----------|
|       |   |           |
| 6 mm  | 1 | K6701M-6  |
| 7 mm  | 1 | K6701M-7  |
| 8 mm  | 1 | K6701M-8  |
| 9 mm  | 1 | K6701M-9  |
| 10 mm | 1 | K6701M-10 |
| 11 mm | 1 | K6701M-11 |
| 12 mm | 1 | K6701M-12 |
| 13 mm | 1 | K6701M-13 |
| 14 mm | 1 | K6701M-14 |

1/4" Square Drive Impact Sockets with Metric Hex Profile and Phosphate Finish - Retail Pack



**SBK6701M**

|       |   |             |
|-------|---|-------------|
|       |   |             |
| 6 mm  | 1 | SBK6701M-6  |
| 7 mm  | 1 | SBK6701M-7  |
| 8 mm  | 1 | SBK6701M-8  |
| 9 mm  | 1 | SBK6701M-9  |
| 10 mm | 1 | SBK6701M-10 |
| 11 mm | 1 | SBK6701M-11 |
| 12 mm | 1 | SBK6701M-12 |
| 13 mm | 1 | SBK6701M-13 |
| 14 mm | 1 | SBK6701M-14 |

1/4" Square Drive Magnetic Impact Sockets with Metric Hex Profile and Phosphate Finish



**KM6701M**

| Hex Size | Quantity | Part Number |
|----------|----------|-------------|
| 7 mm     | 1        | KM6701M-7   |
| 8 mm     | 1        | KM6701M-8   |
| 10 mm    | 1        | KM6701M-10  |

Safety Clamping Springs for 1/4" Impact Socket



**K560F-1**

| Socket Size | Hex Size | Quantity | Part Number |
|-------------|----------|----------|-------------|
| 1/4 in      | 6-14 mm  | 5        | K560F-1     |

3/8" Square Drive Impact Sockets with Metric Hex Profile and Phosphate Finish



**K7401M**

| Hex Size | Quantity | Part Number |
|----------|----------|-------------|
| 7 mm     | 1        | K7401M-7    |
| 8 mm     | 1        | K7401M-8    |
| 9 mm     | 1        | K7401M-9    |
| 10 mm    | 1        | K7401M-10   |
| 11 mm    | 1        | K7401M-11   |
| 12 mm    | 1        | K7401M-12   |
| 13 mm    | 1        | K7401M-13   |
| 14 mm    | 1        | K7401M-14   |
| 15 mm    | 1        | K7401M-15   |
| 16 mm    | 1        | K7401M-16   |
| 17 mm    | 1        | K7401M-17   |
| 18 mm    | 1        | K7401M-18   |

| Hex Size | Quantity | Part Number |
|----------|----------|-------------|
| 19 mm    | 1        | K7401M-19   |
| 20 mm    | 1        | K7401M-20   |
| 21 mm    | 1        | K7401M-21   |
| 22 mm    | 1        | K7401M-22   |
| 24 mm    | 1        | K7401M-24   |

3/8" Square Drive Impact Sockets with Metric Hex Profile and Phosphate Finish - Retail Pack



**SBK7401M**

| Hex Size | Quantity | Part Number |
|----------|----------|-------------|
| 7 mm     | 1        | SBK7401M-7  |
| 8 mm     | 1        | SBK7401M-8  |
| 9 mm     | 1        | SBK7401M-9  |
| 10 mm    | 1        | SBK7401M-10 |
| 11 mm    | 1        | SBK7401M-11 |
| 12 mm    | 1        | SBK7401M-12 |
| 13 mm    | 1        | SBK7401M-13 |
| 14 mm    | 1        | SBK7401M-14 |
| 15 mm    | 1        | SBK7401M-15 |
| 16 mm    | 1        | SBK7401M-16 |
| 17 mm    | 1        | SBK7401M-17 |
| 18 mm    | 1        | SBK7401M-18 |
| 19 mm    | 1        | SBK7401M-19 |
| 20 mm    | 1        | SBK7401M-20 |
| 21 mm    | 1        | SBK7401M-21 |
| 22 mm    | 1        | SBK7401M-22 |
| 24 mm    | 1        | SBK7401M-24 |

3/8" Square Drive Impact Sockets with Imperial Hex Profile



**K7401Z**

| Hex Size | Quantity | Part Number  |
|----------|----------|--------------|
| 3/8 in   | 1        | K7401Z-3/8   |
| 7/16 in  | 1        | K7401Z-7/16  |
| 1/2 in   | 1        | K7401Z-1/2   |
| 9/16 in  | 1        | K7401Z-9/16  |
| 5/8 in   | 1        | K7401Z-5/8   |
| 11/16 in | 1        | K7401Z-11/16 |
| 3/4 in   | 1        | K7401Z-3/4   |
| 13/16 in | 1        | K7401Z-13/16 |
| 7/8 in   | 1        | K7401Z-7/8   |

3/8" Square Drive to 1/4" Bit Holder Power Adaptors



**K172**

| Socket Size | Quantity | Part Number |
|-------------|----------|-------------|
| 1/4"        | 1        | K172        |

3/8" Square Drive Deep Impact Sockets with Metric Hex Profile and Phosphate Finish



**K7406M**

| Hex Size | Quantity | Part Number |
|----------|----------|-------------|
| 10 mm    | 1        | K7406M-10   |
| 13 mm    | 1        | K7406M-13   |
| 17 mm    | 1        | K7406M-17   |

3/8" Square Drive Bit Holder Adaptors with Phosphate Finish



**7407H-7409H**

| Socket Size | Hex Size | Quantity | Part Number |
|-------------|----------|----------|-------------|
| 1/4"        | 3/8"     | 1        | 7407H       |
| 5/16"       | 3/8"     | 1        | 7408H       |
| 11          | 3/8"     | 1        | 7409H       |



3/8" Square Drive Impact Sockets with TORX® Head Profile and Phosphate Finish



**K7401TORX-E**



| Socket Size | Hex Size | Quantity | Part Number   |
|-------------|----------|----------|---------------|
| E5          | M4       | 1        | K7401TORX-E5  |
| E6          | M5       | 1        | K7401TORX-E6  |
| E7          | M6       | 1        | K7401TORX-E7  |
| E8          | M6, M7   | 1        | K7401TORX-E8  |
| E10         | M6, M8   | 1        | K7401TORX-E10 |
| E12         | M8, M10  | 1        | K7401TORX-E12 |
| E14         | M10, M12 | 1        | K7401TORX-E14 |

3/8" Square Drive Impact Power Swivel Sockets with Metric Hex Profile



**KS7401M**



| Socket Size | Quantity | Part Number |
|-------------|----------|-------------|
| 3/8 in      | 1        | KS7401M-9   |
| 3/8 in      | 1        | KS7401M-10  |
| 3/8 in      | 1        | KS7401M-11  |
| 3/8 in      | 1        | KS7401M-12  |
| 3/8 in      | 1        | KS7401M-13  |
| 3/8 in      | 1        | KS7401M-14  |
| 3/8 in      | 1        | KS7401M-15  |
| 3/8 in      | 1        | KS7401M-16  |
| 3/8 in      | 1        | KS7401M-17  |
| 3/8 in      | 1        | KS7401M-18  |
| 3/8 in      | 1        | KS7401M-19  |
| 3/8 in      | 1        | KS7401M-22  |

3/8" Square Drive Ball Joint Sockets with Phosphate Finish



**K7767S**

| Socket Size | Ball Joint Size | Quantity | Part Number |
|-------------|-----------------|----------|-------------|
| 3/8"        | 3/8"            | 1        | K7767S      |

3/8" Square Drive Adaptors with Phosphate Finish



**K6964C**

| Socket Size | Adaptor Size | Quantity | Part Number |
|-------------|--------------|----------|-------------|
| 1/4"        | 3/8"         | 1        | K6964C      |

3/8" Square Drive Adaptors with Phosphate Finish



**K8164C**

| Socket Size | Adaptor Size | Quantity | Part Number |
|-------------|--------------|----------|-------------|
| 1/2"        | 3/8"         | 1        | K8164C      |

3/8" Square Drive Extensions with Phosphate Finish



**K7760C**

| Extension Length | Quantity | Part Number |
|------------------|----------|-------------|
| 75 mm            | 1        | K7760C-1    |
| 150 mm           | 1        | K7760C-2    |

Safety Clamping Springs for 3/8" Impact Socket



**K560F-2/3**

| Socket Size | Spring Size | Quantity | Part Number |
|-------------|-------------|----------|-------------|
| 3/8"        | 7-12        | 5        | K560F-2     |
| 3/8"        | 13-24       | 5        | K560F-3     |

Impact Hexagon Sockets Set with Metric Hex Profile -10 Pcs



**K7401M/10**

| Quantity | Part Number |
|----------|-------------|
| 10       | K7401M/10   |

K7401M-10, K7401M-11, K7401M-12, K7401M-13, K7401M-14, K7401M-15, K7401M-16, K7401M-17, K7401M-18, K7401M-19



3/8" Square Drive Impact Socket Set with TORX® Head Profile and Phosphate Finish - 7 Pcs



**K7401TORX-E-S7**



7 1 K7401TORX-E-S7

K7401TORX-E5, K7401TORX-E6, K7401TORX-E7, K7401TORX-E8, K7401TORX-E10, K7401TORX-E12, K7401TORX-E14



1/2" Square Drive Ultrashort Impact Sockets with Metric Hex Profile and Phosphate Finish



**K7800M**



|       |   |           |
|-------|---|-----------|
| 10 mm | 1 | K7800M-10 |
| 11 mm | 1 | K7800M-11 |
| 12 mm | 1 | K7800M-12 |
| 13 mm | 1 | K7800M-13 |
| 14 mm | 1 | K7800M-14 |
| 15 mm | 1 | K7800M-15 |
| 16 mm | 1 | K7800M-16 |
| 17 mm | 1 | K7800M-17 |
| 18 mm | 1 | K7800M-18 |
| 19 mm | 1 | K7800M-19 |
| 21 mm | 1 | K7800M-21 |
| 22 mm | 1 | K7800M-22 |
| 24 mm | 1 | K7800M-24 |

1/2" Square Drive Impact Sockets with Metric Hex Profile and Phosphate Finish



**K7801M**



|       |    |           |
|-------|----|-----------|
| 8 mm  | 1  | K7801M-8  |
| 9 mm  | 1  | K7801M-9  |
| 10 mm | 1  | K7801M-10 |
| 11 mm | 1  | K7801M-11 |
| 12 mm | 1  | K7801M-12 |
| 13 mm | 1  | K7801M-13 |
| 14 mm | 1  | K7801M-14 |
| 15 mm | 1  | K7801M-15 |
| 16 mm | 1  | K7801M-16 |
| 17 mm | 1  | K7801M-17 |
| 18 mm | 1  | K7801M-18 |
| 19 mm | 1  | K7801M-19 |
| 20 mm | 1  | K7801M-20 |
| 21 mm | 1  | K7801M-21 |
| 22 mm | 1  | K7801M-22 |
| 23 mm | 1  | K7801M-23 |
| 24 mm | 1  | K7801M-24 |
| 25 mm | 1  | K7801M-25 |
| 26 mm | 1  | K7801M-26 |
| 27 mm | 1  | K7801M-27 |
| 28 mm | 1  | K7801M-28 |
| 29 mm | 1  | K7801M-29 |
| 30 mm | 1  | K7801M-30 |
| 32 mm | 15 | K7801M-32 |
| 34 mm | 1  | K7801M-34 |
| 36 mm | 1  | K7801M-36 |

1/2" Square Drive Impact Sockets with Metric Hex Profile and Phosphate Finish - Retail Pack



**SBK7801M**



|       |   |             |
|-------|---|-------------|
| 8 mm  | 1 | SBK7801M-8  |
| 9 mm  | 1 | SBK7801M-9  |
| 10 mm | 1 | SBK7801M-10 |
| 11 mm | 1 | SBK7801M-11 |



|       |   |             |
|-------|---|-------------|
| 12 mm | 1 | SBK7801M-12 |
| 13 mm | 1 | SBK7801M-13 |
| 14 mm | 1 | SBK7801M-14 |
| 15 mm | 1 | SBK7801M-15 |
| 16 mm | 1 | SBK7801M-16 |
| 17 mm | 1 | SBK7801M-17 |
| 18 mm | 1 | SBK7801M-18 |
| 19 mm | 1 | SBK7801M-19 |
| 20 mm | 1 | SBK7801M-20 |
| 21 mm | 1 | SBK7801M-21 |
| 22 mm | 1 | SBK7801M-22 |
| 23 mm | 1 | SBK7801M-23 |
| 24 mm | 1 | SBK7801M-24 |
| 25 mm | 1 | SBK7801M-25 |
| 26 mm | 1 | SBK7801M-26 |
| 27 mm | 1 | SBK7801M-27 |
| 28 mm | 1 | SBK7801M-28 |
| 29 mm | 1 | SBK7801M-29 |
| 30 mm | 1 | SBK7801M-30 |
| 32 mm | 1 | SBK7801M-32 |
| 34 mm | 1 | SBK7801M-34 |
| 36 mm | 1 | SBK7801M-36 |

1/2" Square Drive Deep Impact Sockets with Metric Hex Profile and Phosphate Finish



**K7806M**



|       |   |           |
|-------|---|-----------|
| 10 mm | 1 | K7806M-10 |
| 11 mm | 1 | K7806M-11 |
| 12 mm | 1 | K7806M-12 |
| 13 mm | 1 | K7806M-13 |
| 14 mm | 1 | K7806M-14 |
| 15 mm | 1 | K7806M-15 |
| 16 mm | 1 | K7806M-16 |
| 17 mm | 1 | K7806M-17 |
| 18 mm | 1 | K7806M-18 |
| 19 mm | 1 | K7806M-19 |
| 21 mm | 1 | K7806M-21 |
| 22 mm | 1 | K7806M-22 |
| 23 mm | 1 | K7806M-23 |
| 24 mm | 1 | K7806M-24 |
| 27 mm | 1 | K7806M-27 |
| 30 mm | 1 | K7806M-30 |
| 32 mm | 1 | K7806M-32 |
| 36 mm | 1 | K7806M-36 |

SB: Retail pack on a plastic info card





1/2" Square Drive Deep Impact Sockets with Metric Hex Profile and Phosphate Finish - Retail Pack



**SBK7806M**

| Hex Size | Quantity | Part Number |
|----------|----------|-------------|
| 10 mm    | 1        | SBK7806M-10 |
| 11 mm    | 1        | SBK7806M-11 |
| 12 mm    | 1        | SBK7806M-12 |
| 13 mm    | 1        | SBK7806M-13 |
| 14 mm    | 1        | SBK7806M-14 |
| 15 mm    | 1        | SBK7806M-15 |
| 16 mm    | 1        | SBK7806M-16 |
| 17 mm    | 1        | SBK7806M-17 |
| 18 mm    | 1        | SBK7806M-18 |
| 19 mm    | 1        | SBK7806M-19 |
| 21 mm    | 1        | SBK7806M-21 |
| 22 mm    | 1        | SBK7806M-22 |
| 23 mm    | 1        | SBK7806M-23 |
| 24 mm    | 1        | SBK7806M-24 |
| 27 mm    | 1        | SBK7806M-27 |
| 30 mm    | 1        | SBK7806M-30 |
| 32 mm    | 1        | SBK7806M-32 |
| 36 mm    | 1        | SBK7806M-36 |

SB: Retail pack on a plastic info card

1/2" Square Drive Impact Sockets with Imperial Hex Profile and Phosphate Finish



**K7801Z**

| Hex Size  | Quantity | Part Number   |
|-----------|----------|---------------|
| 3/8 in    | 1        | K7801Z-3/8    |
| 7/16 in   | 1        | K7801Z-7/16   |
| 1/2 in    | 1        | K7801Z-1/2    |
| 9/16 in   | 1        | K7801Z-9/16   |
| 5/8 in    | 1        | K7801Z-5/8    |
| 11/16 in  | 1        | K7801Z-11/16  |
| 3/4 in    | 1        | K7801Z-3/4    |
| 13/16 in  | 1        | K7801Z-13/16  |
| 7/8 in    | 1        | K7801Z-7/8    |
| 15/16 in  | 1        | K7801Z-15/16  |
| 1 in      | 1        | K7801Z-1      |
| 1 1/16 in | 1        | K7801Z-1.1/16 |
| 1 1/8 in  | 1        | K7801Z-1.1/8  |
| 1 1/4 in  | 1        | K7801Z-1.1/4  |
| 1 5/16 in | 5        | K7801Z-1.5/16 |
| 1 3/8 in  | 5        | K7801Z-1.3/8  |
| 1 7/16 in | 5        | K7801Z-1.7/16 |
| 1 1/2 in  | 5        | K7801Z-1.1/2  |

1/2" Square Drive Impact Sockets with Imperial Hex Profile and Phosphate Finish - Retail Pack



**SBK7801Z**

| Hex Size  | Quantity | Part Number     |
|-----------|----------|-----------------|
| 3/8 in    | 1        | SBK7801Z-3/8    |
| 7/16 in   | 1        | SBK7801Z-7/16   |
| 1/2 in    | 1        | SBK7801Z-1/2    |
| 9/16 in   | 1        | SBK7801Z-9/16   |
| 5/8 in    | 1        | SBK7801Z-5/8    |
| 11/16 in  | 1        | SBK7801Z-11/16  |
| 3/4 in    | 1        | SBK7801Z-3/4    |
| 13/16 in  | 1        | SBK7801Z-13/16  |
| 7/8 in    | 1        | SBK7801Z-7/8    |
| 15/16 in  | 1        | SBK7801Z-15/16  |
| 1 in      | 1        | SBK7801Z-1      |
| 1 1/16 in | 1        | SBK7801Z-1.1/16 |
| 1 1/8 in  | 1        | SBK7801Z-1.1/8  |
| 1 1/4 in  | 1        | SBK7801Z-1.1/4  |
| 1 5/16 in | 1        | SBK7801Z-1.5/16 |
| 1 3/8 in  | 1        | SBK7801Z-1.3/8  |

| Hex Size  | Quantity | Part Number     |
|-----------|----------|-----------------|
| 1 7/16 in | 1        | SBK7801Z-1.7/16 |
| 1 1/2 in  | 1        | SBK7801Z-1.1/2  |

SB: Retail pack on a plastic info card

1/2" Square Drive Deep Impact Sockets with Imperial Hex Profile and Phosphate Finish



**K7806Z**

| Hex Size  | Quantity | Part Number   |
|-----------|----------|---------------|
| 3/8 in    | 10       | K7806Z-3/8    |
| 7/16 in   | 5        | K7806Z-7/16   |
| 1/2 in    | 10       | K7806Z-1/2    |
| 9/16 in   | 10       | K7806Z-9/16   |
| 5/8 in    | 5        | K7806Z-5/8    |
| 11/16 in  | 5        | K7806Z-11/16  |
| 3/4 in    | 5        | K7806Z-3/4    |
| 13/16 in  | 5        | K7806Z-13/16  |
| 7/8 in    | 5        | K7806Z-7/8    |
| 15/16 in  | 5        | K7806Z-15/16  |
| 1 in      | 5        | K7806Z-1      |
| 1 1/16 in | 5        | K7806Z-1.1/16 |
| 1 1/8 in  | 5        | K7806Z-1.1/8  |
| 1 1/4 in  | 5        | K7806Z-1.1/4  |
| 1 5/16 in | 5        | K7806Z-1.5/16 |
| 1 3/8 in  | 5        | K7806Z-1.3/8  |
| 1 7/16 in | 5        | K7806Z-1.7/16 |
| 1 1/2 in  | 5        | K7806Z-1.1/2  |

SB: Retail pack on a plastic info card

1/2" Square Drive Reinforced Impact Sockets with Metric Hex Profile and Phosphate Finish



**K7801VM**

| Hex Size | Quantity | Part Number |
|----------|----------|-------------|
| 17 mm    | 1        | K7801VM-17  |
| 19 mm    | 1        | K7801VM-19  |
| 22 mm    | 1        | K7801VM-22  |
| 24 mm    | 1        | K7801VM-24  |

1/2" Square Drive Deep Impact Sockets with Imperial Hex Profile and Phosphate Finish - Retail pack



**SBK7806Z**

| Hex Size | Quantity | Part Number    |
|----------|----------|----------------|
| 3/8 in   | 10       | SBK7806Z-3/8   |
| 7/16 in  | 10       | SBK7806Z-7/16  |
| 1/2 in   | 10       | SBK7806Z-1/2   |
| 9/16 in  | 10       | SBK7806Z-9/16  |
| 5/8 in   | 5        | SBK7806Z-5/8   |
| 11/16 in | 1        | SBK7806Z-11/16 |
| 3/4 in   | 1        | SBK7806Z-3/4   |
| 13/16 in | 1        | SBK7806Z-13/16 |
| 7/8 in   | 1        | SBK7806Z-7/8   |



|           |   |                 |
|-----------|---|-----------------|
| 15/16 in  | 1 | SBK7806Z-15/16  |
| 1 in      | 1 | SBK7806Z-1      |
| 1 1/16 in | 1 | SBK7806Z-1.1/16 |
| 1 1/8 in  | 5 | SBK7806Z-1.1/8  |
| 1 1/4 in  | 1 | SBK7806Z-1.1/4  |
| 1 5/16 in | 1 | SBK7806Z-1.5/16 |
| 1 3/8 in  | 5 | SBK7806Z-1.3/8  |
| 1 7/16 in | 5 | SBK7806Z-1.7/16 |
| 1 1/2 in  | 1 | SBK7806Z-1.1/2  |

SB: Retail pack on a plastic info card

### 1/2" Square Drive Impact Socket Drivers for Hex Head Screws Phosphate Finish



### 7993S



|       |   |           |
|-------|---|-----------|
| 5 mm  | 1 | 7993S0050 |
| 6 mm  | 1 | 7993S0060 |
| 8 mm  | 1 | 7993S0080 |
| 10 mm | 1 | 7993S0100 |
| 12 mm | 1 | 7993S0120 |
| 14 mm | 1 | 7993S0140 |
| 17 mm | 1 | 7993S0170 |
| 18 mm | 1 | 7993S0180 |
| 19 mm | 1 | 7993S0190 |

### 1/2" Square Drive Impact Socket Drivers for TORX® Head Screws Phosphate Finish



### 7994S



|      |   |           |
|------|---|-----------|
| T20  | 1 | 7994S0200 |
| T25  | 1 | 7994S0250 |
| T27  | 1 | 7994S0270 |
| T-30 | 1 | 7994S0300 |
| T-40 | 1 | 7994S0400 |
| T-45 | 1 | 7994S0450 |
| T-50 | 1 | 7994S0500 |
| T-55 | 1 | 7994S0550 |
| T-60 | 1 | 7994S0600 |
| T-70 | 1 | 7994S0700 |

### 1/2" Square Drive Impact Sockets with TORX® Head Profile and Phosphate Finish



### K7801TORX-E



|     |   |               |
|-----|---|---------------|
| E10 | 1 | K7801TORX-E10 |
| E12 | 1 | K7801TORX-E12 |
| E14 | 1 | K7801TORX-E14 |
| E16 | 1 | K7801TORX-E16 |
| E18 | 1 | K7801TORX-E18 |
| E20 | 1 | K7801TORX-E20 |
| E24 | 1 | K7801TORX-E24 |

### 1/2" Square Drive Bit Holders with Phosphate Finish



### 7807H-7809H



|      |         |   |         |
|------|---------|---|---------|
| 1/2" | 1/4 in  | 1 | 7807H   |
| 1/2" | 5/16 in | 1 | 7808H   |
| 1/2" | 11.2 mm | 1 | 7809H   |
| 1/2" | 1/4 in  | 1 | SB7807H |
| 1/2" | 5/16 in | 1 | SB7808H |
| 1/2" | 7/16 in | 1 | SB7809H |

### 1/2" Square Drive Extensions with Phosphate Finish



### K8160D



|        |   |            |
|--------|---|------------|
| 75 mm  | 1 | K8160D-1   |
| 125 mm | 1 | K8160D-2   |
| 250 mm | 1 | K8160D-3   |
| 75 mm  | 1 | SBK8160D-1 |
| 125 mm | 1 | SBK8160D-2 |
| 250 mm | 1 | SBK8160D-3 |

### 1/2" Square Drive Ball Joint Sockets with Phosphate Finish



### K8167S



|      |      |   |        |
|------|------|---|--------|
| 1/2" | 1/2" | 1 | K8167S |
|------|------|---|--------|

### 1/2" Square Drive Adaptors with Phosphate Finish



### K7764D/SBK7764D



|        |        |   |          |
|--------|--------|---|----------|
| M 3/8" | F 1/2" | 1 | K7764D   |
| M 3/8" | F 1/2" | 1 | SBK7764D |

SB: Retail pack

### 1/2" Square Drive to 3/4" Increasing Adaptor with Phosphate Finish



### K8964D/SBK8964D



|        |        |   |          |
|--------|--------|---|----------|
| 3/4"   | 1/2"   | 1 | K8964D   |
| M 3/4" | F 1/2" | 1 | SBK8964D |

SB: Retail pack on a plastic info card



Safety Clamping Springs for 1/2" Impact Socket



**K560F-4/5**

|      |          |   |         |
|------|----------|---|---------|
|      |          |   |         |
| 1/2" | 10-14 mm | 5 | K560F-4 |
| 1/2" | 15-32 mm | 5 | K560F-5 |

1/2" Square Drive Ultrashort impact socket set, 1/2" - 13 Pcs



**K7800M/13**

|                   |             |
|-------------------|-------------|
|                   |             |
| 43 x 128 x 195 mm | 1 K7800M/13 |

K7800M-10, K7800M-11, K7800M-12, K7800M-13, K7800M-14, K7800M-15, K7800M-16, K7800M-17, K7800M-18, K7800M-19, K7800M-21, K7800M-22, K7800M-24

4750IB-A5

1/2" Square Drive Deep Impact Socket Set in Case with Metric Hex Profile and Phosphate Finish - 4 Pcs



**K7806M/S4**

|   |             |
|---|-------------|
|   |             |
| 4 | 1 K7806M/S4 |

K7806M-19, K7806M-22, K7806M-17, K7806M-24

4750IB-A5

1/2" Square Drive Reinforced Impact Socket Set with Metric Hex Profile and Phosphate Finish - 4 Pcs



**K7801VM/S4**

|   |              |
|---|--------------|
|   |              |
| 4 | 1 K7801VM/S4 |

K7801VM-22, K7801VM-19, K7801VM-17, K7801VM-24

1/2" Square Drive Impact Socket Set with Imperial Hex Profile and Phosphate Finish - 10 Pcs



**K7801Z/10**

|    |                   |             |
|----|-------------------|-------------|
|    |                   |             |
| 10 | 60 x 220 x 280 mm | 1 K7801Z/10 |

K7801Z-7/16, K7801Z-1/2, K7801Z-11/16, K7801Z-5/8, K7801Z-13/16, K7801Z-3/4, K7801Z-15/16, K7801Z-7/8, K7801Z-1, K7801Z-9/16

1/2" Square Drive Deep Impact Socket Set with Imperial Hex Profile and Phosphate Finish - 10 Pcs



**K7806Z/10**

|    |                   |             |
|----|-------------------|-------------|
|    |                   |             |
| 10 | 60 x 220 x 280 mm | 1 K7806Z/10 |

K7806Z-7/16, K7806Z-1/2, K7806Z-9/16, K7806Z-3/4, K7806Z-13/16, K7806Z-11/16, K7806Z-1, K7806Z-7/8, K7806Z-15/16, K7806Z-5/8

1/2" Square Drive Deep Impact Socket Set with Metric Hex Profile and Phosphate Finish - 14 Pcs



**DD/S14**

|    |          |
|----|----------|
|    |          |
| 14 | 4 DD/S14 |

K7806M-10, K7806M-11, K7806M-12, K7806M-13, K7806M-14, K7806M-15, K7806M-16, K7806M-17, K7806M-18, K7806M-19, K7806M-21, K7806M-22, K7806M-24, K7806M-27

1/2" Square Drive Mixed Impact Socket Set with Metric Hex Profile and Phosphate Finish - 20 Pcs



**D-DD/**

|    |            |
|----|------------|
|    |            |
| 20 | 4 D-DD/S20 |

K7801M-10, K7801M-11, K7801M-12, K7801M-13, K7801M-14, K7801M-15, K7801M-16, K7801M-17, K7801M-18, K7801M-19

K7806M-10, K7806M-11, K7806M-12, K7806M-13, K7806M-14, K7806M-16, K7806M-17, K7806M-18, K7806M-19

1/2" Square Drive Impact Socket Set with Metric Hex Profile and Phosphate Finish - 10 Pcs



**D/**

|    |   |       |
|----|---|-------|
|    |   |       |
| 10 | 6 | D/S10 |

K7801M-10, K7801M-11, K7801M-12, K7801M-13, K7801M-14, K7801M-15, K7801M-16, K7801M-17, K7801M-18, K7801M-19

1/2" Square Drive Impact Socket Set with Metric Hex Profile and Phosphate Finish - 14 Pcs



**D/S14**

|    |   |       |
|----|---|-------|
|    |   |       |
| 14 | 6 | D/S14 |

K7801M-10, K7801M-11, K7801M-12, K7801M-13, K7801M-14, K7801M-15, K7801M-16, K7801M-17, K7801M-18, K7801M-19, K7801M-21, K7801M-22, K7801M-24, K7801M-27

1/2" Square Drive Deep Impact Socket Set with Metric Hex Profile and Phosphate Finish - 10 Pcs



**DD/**

|    |   |        |
|----|---|--------|
|    |   |        |
| 10 | 6 | DD/S10 |

K7806M-10, K7806M-11, K7806M-12, K7806M-13, K7806M-14, K7806M-15, K7806M-16, K7806M-17, K7806M-18, K7806M-19

3/4" Square Drive Impact Sockets with Metric Hex Profile and Phosphate Finish



**K8901M**

|       |   |           |
|-------|---|-----------|
|       |   |           |
| 17 mm | 1 | K8901M-17 |
| 18 mm | 1 | K8901M-18 |
| 19 mm | 1 | K8901M-19 |
| 21 mm | 1 | K8901M-21 |
| 22 mm | 1 | K8901M-22 |
| 23 mm | 1 | K8901M-23 |
| 24 mm | 1 | K8901M-24 |
| 27 mm | 1 | K8901M-27 |
| 28 mm | 1 | K8901M-28 |
| 29 mm | 1 | K8901M-29 |
| 30 mm | 1 | K8901M-30 |
| 32 mm | 1 | K8901M-32 |
| 33 mm | 1 | K8901M-33 |
| 34 mm | 1 | K8901M-34 |
| 36 mm | 1 | K8901M-36 |
| 38 mm | 1 | K8901M-38 |
| 41 mm | 1 | K8901M-41 |
| 46 mm | 1 | K8901M-46 |
| 50 mm | 1 | K8901M-50 |
| 55 mm | 1 | K8901M-55 |
| 60 mm | 1 | K8901M-60 |

SB: Retail pack on a plastic info card

3/4" Square Drive Impact Sockets with Metric Hex Profile Hang sell



**SBK8901M**

|       |   |             |
|-------|---|-------------|
|       |   |             |
| 17 mm | 1 | SBK8901M-17 |
| 18 mm | 1 | SBK8901M-18 |
| 19 mm | 1 | SBK8901M-19 |
| 21 mm | 1 | SBK8901M-21 |
| 22 mm | 1 | SBK8901M-22 |
| 23 mm | 1 | SBK8901M-23 |
| 24 mm | 1 | SBK8901M-24 |
| 27 mm | 1 | SBK8901M-27 |
| 28 mm | 1 | SBK8901M-28 |
| 29 mm | 1 | SBK8901M-29 |
| 30 mm | 1 | SBK8901M-30 |
| 32 mm | 1 | SBK8901M-32 |
| 33 mm | 1 | SBK8901M-33 |
| 34 mm | 1 | SBK8901M-34 |
| 36 mm | 1 | SBK8901M-36 |
| 38 mm | 1 | SBK8901M-38 |
| 41 mm | 1 | SBK8901M-41 |
| 46 mm | 1 | SBK8901M-46 |
| 55 mm | 1 | SBK8901M-55 |
| 60 mm | 1 | SBK8901M-60 |
| 50 mm | 1 | SBK8901M-50 |

SB: Retail pack on a plastic info card

3/4" Square Drive Deep Impact Sockets with Metric Hex Profile and Phosphate Finish



**K8906M**

|       |   |           |
|-------|---|-----------|
|       |   |           |
| 17 mm | 1 | K8906M-17 |
| 19 mm | 1 | K8906M-19 |
| 21 mm | 1 | K8906M-21 |
| 22 mm | 1 | K8906M-22 |
| 24 mm | 1 | K8906M-24 |
| 27 mm | 1 | K8906M-27 |
| 30 mm | 1 | K8906M-30 |
| 32 mm | 1 | K8906M-32 |
| 33 mm | 1 | K8906M-33 |
| 34 mm | 1 | K8906M-34 |
| 36 mm | 1 | K8906M-36 |
| 41 mm | 1 | K8906M-41 |
| 42 mm | 1 | K8906M-42 |
| 46 mm | 1 | K8906M-46 |

SB: Retail pack on a plastic info card





3/4" Square Drive Impact Sockets with Imperial Hex Profile and Phosphate Finish



| Hex Profile | Part Number     |
|-------------|-----------------|
| 1.1/4 in    | 1 K8906Z-1.1/4  |
| 1.5/16 in   | 1 K8906Z-1.5/16 |
| 1.3/8 in    | 1 K8906Z-1.3/8  |
| 1.7/16 in   | 1 K8906Z-1.7/16 |
| 1.1/2 in    | 1 K8906Z-1.1/2  |
| 1.5/8 in    | 1 K8906Z-1.5/8  |
| 1.3/4 in    | 1 K8906Z-1.3/4  |
| 2 mm        | 1 K8906Z-2      |

SB: Retail pack on a plastic info card

**K8901Z**

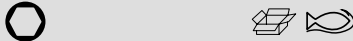

|            |                  |
|------------|------------------|
| 11/16 in   | 1 K8901Z-11/16   |
| 3/4 in     | 1 K8901Z-3/4     |
| 13/16 in   | 1 K8901Z-13/16   |
| 7/8 in     | 1 K8901Z-7/8     |
| 15/16 in   | 1 K8901Z-15/16   |
| 1 in       | 1 K8901Z-1       |
| 1 1/16 in  | 1 K8901Z-1.1/16  |
| 1 1/8 in   | 1 K8901Z-1.1/8   |
| 1 3/16 in  | 1 K8901Z-1.3/16  |
| 1 1/4 in   | 1 K8901Z-1.1/4   |
| 1 5/16 in  | 1 K8901Z-1.5/16  |
| 1 3/8 in   | 1 K8901Z-1.3/8   |
| 1 7/16 in  | 1 K8901Z-1.7/16  |
| 1 1/2 in   | 1 K8901Z-1.1/2   |
| 1 9/16 in  | 1 K8901Z-1.9/16  |
| 1 5/8 in   | 1 K8901Z-1.5/8   |
| 1 11/16 in | 1 K8901Z-1.11/16 |
| 1 3/4 in   | 1 K8901Z-1.3/4   |
| 1 13/16 in | 1 K8901Z-1.13/16 |
| 1 7/8 in   | 1 K8901Z-1.7/8   |
| 1 15/16 in | 1 K8901Z-1.15/16 |
| 2 in       | 1 K8901Z-2       |
| 2 1/16 in  | 1 K8901Z-2.1/16  |
| 2 3/16 in  | 1 K8901Z-2.3/16  |
| 2 1/4 in   | 1 K8901Z-2.1/4   |
| 2 3/8 in   | 1 K8901Z-2.3/8   |

SB: Retail pack on a plastic info card

3/4" Square Drive Deep Impact Sockets with Imperial Hex Profile and Phosphate Finish



**K8906Z**



|           |                 |
|-----------|-----------------|
| 3/4 in    | 1 K8906Z-3/4    |
| 13/16 in  | 1 K8906Z-13/16  |
| 7/8 in    | 1 K8906Z-7/8    |
| 15/16 in  | 1 K8906Z-15/16  |
| 1 mm      | 1 K8906Z-1      |
| 1 1/16 in | 1 K8906Z-1.1/16 |
| 1.1/8 in  | 1 K8906Z-1.1/8  |

3/4" Square Drive Impact Socket Drivers for Hex Head Screws Phosphate Finish



**7993T**



|       |             |
|-------|-------------|
| 12 mm | 1 7993T0120 |
| 14 mm | 1 7993T0140 |
| 17 mm | 1 7993T0170 |
| 19 mm | 1 7993T0190 |
| 22 mm | 1 7993T0220 |
| 24 mm | 1 7993T0240 |

3/4" Square Drive Bit Holders with Phosphate Finish



**K8909H**



|       |      |            |
|-------|------|------------|
| 22 mm | 3/4" | 1 K8909H-5 |
|-------|------|------------|

3/4" Square Drive Ball Joint Sockets with Phosphate Finish



**K8967S**



|      |      |          |
|------|------|----------|
| 3/4" | 3/4" | 1 K8967S |
|------|------|----------|

3/4" Square Drive Adaptors with Phosphate Finish



**K8164F**



|      |      |          |
|------|------|----------|
| 1/2" | 3/4" | 1 K8164F |
|------|------|----------|

3/4" Square Drive to 1" Socket Increasing Adaptors with Phosphate Finish



**K9564F**

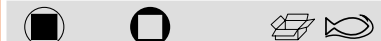

|    |      |          |
|----|------|----------|
| 1" | 3/4" | 1 K9564F |
|----|------|----------|



3/4" Square Drive Extensions with Phosphate Finish



**K8960F**



|        |   |          |
|--------|---|----------|
| 175 mm | 1 | K8960F-2 |
| 250 mm | 1 | K8960F-3 |
| 325 mm | 1 | K8960F-4 |

Safety Clamping Springs for 3/4" Impact Socket



**K560F-6**



|      |          |   |         |
|------|----------|---|---------|
| 3/4" | 17-46 mm | 5 | K560F-6 |
|------|----------|---|---------|

3/4" Square Drive Impact Socket Set with Metric Hex Profile and Phosphate Finish - 8 Pcs



**K8901M/8**



|   |                   |   |          |
|---|-------------------|---|----------|
| 8 | 65 x 240 x 350 mm | 1 | K8901M/8 |
|---|-------------------|---|----------|

K8901M-27, K8901M-24, K8901M-21, K8901M-22, K8901M-30, K8901M-32, K8901M-36, K8901M-41

3/4" Square Drive Deep Impact Socket Set with Metric Hex Profile and Phosphate Finish - 8 Pcs



**K8906M/8**



|   |                   |   |          |
|---|-------------------|---|----------|
| 8 | 80 x 250 x 315 mm | 1 | K8906M/8 |
|---|-------------------|---|----------|

K8906M-24, K8906M-27, K8906M-30, K8906M-41, K8906M-36, K8906M-21, K8906M-22, K8906M-32

3/4" Square Drive Impact Socket Set with Imperial Hex Profile and Phosphate Finish - 8 Pcs



**K8901Z/8**



|   |                   |   |          |
|---|-------------------|---|----------|
| 8 | 80 x 250 x 310 mm | 1 | K8901Z/8 |
|---|-------------------|---|----------|

K8901Z-1.1/16, K8901Z-1, K8901Z-1.3/8, K8901Z-1.5/16, K8901Z-1.1/4, K8901Z-1.1/2, K8901Z-1.7/16, K8901Z-1.1/8

3/4" Square Drive Impact Socket Set with Imperial Hex Profile and Phosphate Finish - 18 Pcs



**K8901Z/18**



|    |                    |   |           |
|----|--------------------|---|-----------|
| 18 | 100 x 210 x 595 mm | 1 | K8901Z/18 |
|----|--------------------|---|-----------|

K8901Z-11/16, K8901Z-3/4, K8901Z-13/16, K8901Z-7/8, K8901Z-15/16, K8901Z-1, K8901Z-1.1/16, K8901Z-1.1/8, K8901Z-1.3/16, K8901Z-1.1/4, K8901Z-1.5/16, K8901Z-1.3/8, K8901Z-1.7/16, K8901Z-1.1/2, K8901Z-1.9/16, K8901Z-1.5/8, K8901Z-1.11/16, K8901Z-1.3/4

3/4" Square Drive Deep Impact Socket Set with Imperial Hex Profile and Phosphate Finish - 8 Pcs



**K8906Z/8**



|   |                    |   |          |
|---|--------------------|---|----------|
| 8 | 125 x 250 x 110 mm | 1 | K8906Z/8 |
|---|--------------------|---|----------|

K8906Z-1, K8906Z-1.1/16, K8906Z-1.1/8, K8906Z-1.1/4, K8906Z-1.5/16, K8906Z-1.3/8, K8906Z-1.7/16, K8906Z-1.1/2



1" Square Drive Impact Sockets with Metric Hex Profile and Phosphate Finish



**K9501M**



|       |   |           |
|-------|---|-----------|
| 22 mm | 1 | K9501M-22 |
| 24 mm | 1 | K9501M-24 |
| 27 mm | 1 | K9501M-27 |
| 30 mm | 1 | K9501M-30 |
| 32 mm | 1 | K9501M-32 |
| 33 mm | 1 | K9501M-33 |
| 34 mm | 1 | K9501M-34 |
| 36 mm | 1 | K9501M-36 |
| 38 mm | 1 | K9501M-38 |
| 41 mm | 1 | K9501M-41 |
| 42 mm | 1 | K9501M-42 |
| 46 mm | 1 | K9501M-46 |
| 50 mm | 1 | K9501M-50 |
| 55 mm | 1 | K9501M-55 |
| 60 mm | 1 | K9501M-60 |
| 65 mm | 1 | K9501M-65 |
| 70 mm | 1 | K9501M-70 |
| 75 mm | 1 | K9501M-75 |
| 80 mm | 1 | K9501M-80 |
| 85 mm | 1 | K9501M-85 |

1" Square Drive Impact Sockets with Imperial Hex Profile and Phosphate Finish



**K9501Z**



|            |   |                |
|------------|---|----------------|
| 1 in       | 1 | K9501Z-1       |
| 1 1/16 in  | 1 | K9501Z-1.1/16  |
| 1 1/8 in   | 1 | K9501Z-1.1/8   |
| 1 3/16 in  | 1 | K9501Z-1.3/16  |
| 1 1/4 in   | 1 | K9501Z-1.1/4   |
| 1 5/16 in  | 1 | K9501Z-1.5/16  |
| 1 3/8 in   | 1 | K9501Z-1.3/8   |
| 1 7/16 in  | 1 | K9501Z-1.7/16  |
| 1 1/2 in   | 1 | K9501Z-1.1/2   |
| 1 9/16 in  | 1 | K9501Z-1.9/16  |
| 1 5/8 in   | 1 | K9501Z-1.5/8   |
| 1 11/16 in | 1 | K9501Z-1.11/16 |
| 1 3/4 in   | 1 | K9501Z-1.3/4   |
| 1 13/16 in | 1 | K9501Z-1.13/16 |
| 1 7/8 in   | 1 | K9501Z-1.7/8   |
| 15/16 in   | 1 | K9501Z-1.15/16 |
| 2 in       | 1 | K9501Z-2       |
| 2 1/8 in   | 1 | K9501Z-2.1/8   |
| 2 3/16 in  | 1 | K9501Z-2.3/16  |
| 2 1/4 in   | 1 | K9501Z-2.1/4   |
| 2 5/16 in  | 1 | K9501Z-2.5/16  |
| 2 9/16 in  | 1 | K9501Z-2.9/16  |
| 2 3/4 in   | 1 | K9501Z-2.3/4   |

1" Square Drive Bit Holders with 22 mm Male Hex Drive with Phosphate Finish



**K9509H5**



|       |    |   |         |
|-------|----|---|---------|
| 22 mm | 1" | 1 | K9509H5 |
|-------|----|---|---------|

1" Square Drive Deep Impact Sockets with Metric Hex Profile and Phosphate Finish



**K9506M**



|       |   |           |
|-------|---|-----------|
| 22 mm | 1 | K9506M-22 |
| 24 mm | 1 | K9506M-24 |
| 27 mm | 1 | K9506M-27 |
| 30 mm | 1 | K9506M-30 |
| 32 mm | 1 | K9506M-32 |
| 33 mm | 1 | K9506M-33 |
| 34 mm | 1 | K9506M-34 |
| 36 mm | 1 | K9506M-36 |
| 38 mm | 1 | K9506M-38 |
| 41 mm | 1 | K9506M-41 |
| 46 mm | 1 | K9506M-46 |
| 50 mm | 1 | K9506M-50 |
| 55 mm | 1 | K9506M-55 |
| 60 mm | 1 | K9506M-60 |

1" Square Drive Deep Impact Sockets with Imperial Hex Profile and Phosphate Finish



**K9506Z**



|            |   |                |
|------------|---|----------------|
| 1 in       | 1 | K9506Z-1       |
| 1 1/16 in  | 1 | K9506Z-1.1/16  |
| 1 3/16 in  | 1 | K9506Z-1.3/16  |
| 1 1/4 in   | 1 | K9506Z-1.1/4   |
| 1 7/16 in  | 1 | K9506Z-1.7/16  |
| 1 1/2 in   | 1 | K9506Z-1.1/2   |
| 1 5/8 in   | 1 | K9506Z-1.5/8   |
| 1 13/16 in | 1 | K9506Z-1.13/16 |
| 1 7/8 in   | 1 | K9506Z-1.7/8   |

1" Square Drive Socket Drivers for Hex Head Screws Phosphate Finish



**7993M**



|       |   |           |
|-------|---|-----------|
| 17 mm | 1 | 7993M0170 |
| 19 mm | 1 | 7993M0190 |
| 22 mm | 1 | 7993M0220 |
| 27 mm | 1 | 7993M0270 |

1" Square Drive Adaptors with Phosphate Finish



**K8964G**



|      |    |   |        |
|------|----|---|--------|
| 3/4" | 1" | 1 | K8964G |
|------|----|---|--------|

1" to 1-1/2" Square Drive Adaptor with Phosphate Finish



**K9895G**

|        |    |   |        |
|--------|----|---|--------|
|        |    |   |        |
| 1 1/2" | 1" | 1 | K9895G |

1" Square Drive Extensions with Phosphate Finish



**K9560G**

|        |   |          |
|--------|---|----------|
|        |   |          |
| 100 mm | 1 | K9560G-0 |
| 125 mm | 1 | K9560G-1 |
| 175 mm | 1 | K9560G-2 |
| 325 mm | 1 | K9560G-3 |
| 300 mm | 1 | K9560G-4 |
| 400 mm | 1 | K9560G-5 |

1" Square Drive Ball Joint Sockets with Phosphate Finish



**K9567S**

|    |   |        |
|----|---|--------|
|    |   |        |
| 1" | 1 | K9567S |

Bits with 22 mm Male Hex Drive



**K8909ML/K9509ML**

|       |   |            |
|-------|---|------------|
|       |   |            |
| 12 mm | 1 | K8909ML-12 |
| 14 mm | 1 | K8909ML-14 |
| 17 mm | 1 | K8909ML-17 |
| 19 mm | 1 | K9509ML-19 |
| 22 mm | 1 | K9509ML-22 |
| 24 mm | 1 | K9509ML-24 |

Safety Clamping Springs for 1" and 1-1/2" Impact Socket



**K560F-7/8**

|            |                  |   |         |
|------------|------------------|---|---------|
|            |                  |   |         |
| 1"         | 19-70 mm         | 5 | K560F-7 |
| 1 & 1 1/2" | 75-80 & 46-90 mm | 5 | K560F-8 |

1-1/2" Square Drive Impact Sockets with Metric Hex Profile and Phosphate Finish



**K9801M**

|       |   |           |
|-------|---|-----------|
|       |   |           |
| 46 mm | 1 | K9801M-46 |
| 50 mm | 1 | K9801M-50 |
| 55 mm | 1 | K9801M-55 |
| 60 mm | 1 | K9801M-60 |

|        |   |            |
|--------|---|------------|
|        |   |            |
| 65 mm  | 1 | K9801M-65  |
| 70 mm  | 1 | K9801M-70  |
| 75 mm  | 1 | K9801M-75  |
| 80 mm  | 1 | K9801M-80  |
| 85 mm  | 1 | K9801M-85  |
| 90 mm  | 1 | K9801M-90  |
| 95 mm  | 1 | K9801M-95  |
| 100 mm | 1 | K9801M-100 |
| 105 mm | 1 | K9801M-105 |
| 110 mm | 1 | K9801M-110 |
| 115 mm | 1 | K9801M-115 |
| 120 mm | 1 | K9801M-120 |
| 125 mm | 1 | K9801M-125 |
| 130 mm | 1 | K9801M-130 |
| 135 mm | 1 | K9801M-135 |
| 140 mm | 1 | K9801M-140 |
| 145 mm | 1 | K9801M-145 |
| 150 mm | 1 | K9801M-150 |
| 155 mm | 1 | K9801M-155 |

1-1/2" Square Drive Deep Impact Sockets with Metric Hex Profile and Phosphate Finish



**K9806M**

|        |   |            |
|--------|---|------------|
|        |   |            |
| 41 mm  | 1 | K9806M-41  |
| 46 mm  | 1 | K9806M-46  |
| 50 mm  | 1 | K9806M-50  |
| 55 mm  | 1 | K9806M-55  |
| 60 mm  | 1 | K9806M-60  |
| 65 mm  | 1 | K9806M-65  |
| 70 mm  | 1 | K9806M-70  |
| 75 mm  | 1 | K9806M-75  |
| 80 mm  | 1 | K9806M-80  |
| 85 mm  | 1 | K9806M-85  |
| 90 mm  | 1 | K9806M-90  |
| 95 mm  | 1 | K9806M-95  |
| 100 mm | 1 | K9806M-100 |
| 105 mm | 1 | K9806M-105 |
| 110 mm | 1 | K9806M-110 |
| 115 mm | 1 | K9806M-115 |
| 120 mm | 1 | K9806M-120 |



1-1/2" Square Drive Impact Sockets with Imperial Hex Profile and Phosphate Finish



**K9801Z**



|            |   |                |
|------------|---|----------------|
| 1 3/8 in   | 1 | K9801Z-1.3/8   |
| 1 7/16 in  | 1 | K9801Z-1.7/16  |
| 1 1/2 in   | 1 | K9801Z-1.1/2   |
| 1 9/16 in  | 1 | K9801Z-1.9/16  |
| 1 5/8 in   | 1 | K9801Z-1.5/8   |
| 1 11/16 in | 1 | K9801Z-1.11/16 |
| 1 3/4 in   | 1 | K9801Z-1.3/4   |
| 1 13/16 in | 1 | K9801Z-1.13/16 |
| 1 7/8 in   | 1 | K9801Z-1.7/8   |
| 1 15/16 in | 1 | K9801Z-1.15/16 |
| 2 in       | 1 | K9801Z-2       |
| 2 1/16 in  | 1 | K9801Z-2.1/16  |
| 2 1/8 in   | 1 | K9801Z-2.1/8   |
| 2 3/16 in  | 1 | K9801Z-2.3/16  |
| 2 1/4 in   | 1 | K9801Z-2.1/4   |
| 2 5/16 in  | 1 | K9801Z-2.5/16  |
| 2 3/8 in   | 1 | K9801Z-2.3/8   |
| 2 7/16 in  | 1 | K9801Z-2.7/16  |
| 2 1/2 in   | 1 | K9801Z-2.1/2   |
| 2 9/16 in  | 1 | K9801Z-2.9/16  |
| 2 5/8 in   | 1 | K9801Z-2.5/8   |
| 2 11/16 in | 1 | K9801Z-2.11/16 |
| 2 3/4 in   | 1 | K9801Z-2.3/4   |
| 2 13/16 in | 1 | K9801Z-2.13/16 |
| 2 7/8 in   | 1 | K9801Z-2.7/8   |
| 2 15/16 in | 1 | K9801Z-2.15/16 |
| 3 in       | 1 | K9801Z-3       |
| 3 1/16 in  | 1 | K9801Z-3.1/16  |
| 3 1/8 in   | 1 | K9801Z-3.1/8   |
| 3 1/4 in   | 1 | K9801Z-3.1/4   |
| 3 5/16 in  | 1 | K9801Z-3.5/16  |
| 3 3/8 in   | 1 | K9801Z-3.3/8   |
| 3 7/16 in  | 1 | K9801Z-3.7/16  |
| 3 1/2 in   | 1 | K9801Z-3.1/2   |
| 3 9/16 in  | 1 | K9801Z-3.9/16  |
| 3 5/8 in   | 1 | K9801Z-3.5/8   |
| 3 11/16 in | 1 | K9801Z-3.11/16 |
| 3 3/4 in   | 1 | K9801Z-3.3/4   |
| 3 13/16 in | 1 | K9801Z-3.13/16 |
| 3 7/8 in   | 1 | K9801Z-3.7/8   |
| 3 15/16 in | 1 | K9801Z-3.15/16 |
| 4 in       | 1 | K9801Z-4       |
| 4 1/16 in  | 1 | K9801Z-4.1/16  |
| 4 1/8 in   | 1 | K9801Z-4.1/8   |
| 4 1/4 in   | 1 | K9801Z-4.1/4   |
| 4 5/16 in  | 1 | K9801Z-4.5/16  |
| 4 3/8 in   | 1 | K9801Z-4.3/8   |
| 4 7/16 in  | 1 | K9801Z-4.7/16  |
| 4 1/2 in   | 1 | K9801Z-4.1/2   |
| 4 5/8 in   | 1 | K9801Z-4.5/8   |
| 4 3/4 in   | 1 | K9801Z-4.3/4   |

1-1/2" Square Drive Deep Impact Sockets with Imperial Hex Profile and Phosphate Finish



**K9806Z**



|            |   |                |
|------------|---|----------------|
| 1 3/8 in   | 1 | K9806Z-1.3/8   |
| 1 7/16 in  | 1 | K9806Z-1.7/16  |
| 1 1/2 in   | 1 | K9806Z-1.1/2   |
| 1 5/8 in   | 1 | K9806Z-1.5/8   |
| 1 11/16 in | 1 | K9806Z-1.11/16 |
| 2 in       | 1 | K9806Z-2       |
| 2 1/16 in  | 1 | K9806Z-2.1/16  |
| 2 3/16 in  | 1 | K9806Z-2.3/16  |
| 2 1/4 in   | 1 | K9806Z-2.1/4   |
| 2 5/16 in  | 1 | K9806Z-2.5/16  |
| 2 3/8 in   | 1 | K9806Z-2.3/8   |
| 2 7/16 in  | 1 | K9806Z-2.7/16  |
| 2 1/2 in   | 1 | K9806Z-2.1/2   |
| 2 9/16 in  | 1 | K9806Z-2.9/16  |
| 2 5/8 in   | 1 | K9806Z-2.5/8   |
| 2 11/16 in | 1 | K9806Z-2.11/16 |
| 2 3/4 in   | 1 | K9806Z-2.3/4   |
| 2 13/16 in | 1 | K9806Z-2.13/16 |
| 2 7/8 in   | 1 | K9806Z-2.7/8   |
| 2 15/16 in | 1 | K9806Z-2.15/16 |
| 3 in       | 1 | K9806Z-3       |
| 3 1/16 in  | 1 | K9806Z-3.1/16  |
| 3 1/8 in   | 1 | K9806Z-3.1/8   |
| 3 3/16 in  | 1 | K9806Z-3.3/16  |
| 3 1/4 in   | 1 | K9806Z-3.1/4   |
| 3 5/16 in  | 1 | K9806Z-3.5/16  |
| 3 3/8 in   | 1 | K9806Z-3.3/8   |
| 3 7/16 in  | 1 | K9806Z-3.7/16  |
| 3 1/2 in   | 1 | K9806Z-3.1/2   |
| 3 9/16 in  | 1 | K9806Z-3.9/16  |
| 3 5/8 in   | 1 | K9806Z-3.5/8   |
| 3 11/16 in | 1 | K9806Z-3.11/16 |
| 3 3/4 in   | 1 | K9806Z-3.3/4   |
| 3 13/16 in | 1 | K9806Z-3.13/16 |
| 3 7/8 in   | 1 | K9806Z-3.7/8   |
| 3 15/16 in | 1 | K9806Z-3.15/16 |
| 4 in       | 1 | K9806Z-4       |
| 4 1/16 in  | 1 | K9806Z-4.1/16  |
| 4 1/8 in   | 1 | K9806Z-4.1/8   |
| 4 1/4 in   | 1 | K9806Z-4.1/4   |
| 4 5/16 in  | 1 | K9806Z-4.5/16  |
| 4 3/8 in   | 1 | K9806Z-4.3/8   |
| 4 7/16 in  | 1 | K9806Z-4.7/16  |
| 4 1/2 in   | 1 | K9806Z-4.1/2   |
| 4 5/8 in   | 1 | K9806Z-4.5/8   |
| 4 3/4 in   | 1 | K9806Z-4.3/4   |

1-1/2" Square Drive Ball Joints with Phosphate Finish



**K9867S**



|       |       |          |
|-------|-------|----------|
| 1 1/2 | 1 1/2 | 1 K9867S |
|-------|-------|----------|

1-1/2" Square Drive Extensions with Phosphate Finish



**K9860H**



|        |   |          |
|--------|---|----------|
| 255 mm | 1 | K9860H-1 |
| 380 mm | 1 | K9860H-2 |
| 510 mm | 1 | K9860H-3 |

1-1/2" Square Drive Adaptors with Phosphate Finish



**K9598H**



|   |       |          |
|---|-------|----------|
| 1 | 1 1/2 | 1 K9598H |
|---|-------|----------|

1.1/2" Square Drive to 2.1/2" Socket  
Increasing Adaptors with Phosphate Finish



**K9998H**



2 1/2 1 1/2 1 K9998H

2.1/2" Square Drive to 1.1/2" Socket  
Reducing Adaptor with Phosphate Finish



**K9899H**



1 1/2 2 1/2 1 K9899H

Safety Clamping Springs for 1-1/2" Impact  
Socket



**K560F-9**

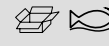

1 1/2" 95-120 mm 5 K560F-9







**BAHCO**



# Screwdrivers



**ERGO™ SCREWDRIVERS WITH RIGGED RUBBER GRIP & COLOUR ID**

ERGO™ TORX® Screwdriver Set with Rubber Grip - 5 Pcs



**BE-9885**

5 1 BE-9885

BE-8910, BE-8930, BE-8915, BE-8920, BE-8925

ERGO™ Slotted/Phillips Screwdriver Set with Rubber Grip - 6 Pcs



**BE-9881**

6 1 BE-9881

BE-8020, BE-8040  
BE-8150, BE-8155  
BE-8620, BE-8610

ERGO™ Slotted/Pozidriv Screwdriver Set with Rubber Grip - 6 Pcs



**BE-9882**

6 1 BE-9882

BE-8020, BE-8040  
BE-8155, BE-8150  
BE-8810, BE-8820

ERGO™ Slotted-Straight/Phillips/Pozidriv Screwdriver Set with Rubber Grip - 6 Pcs



**BE-9884**

6 1 BE-9884

BE-8611, BE-8621  
BE-8040, BE-8241  
BE-8811, BE-8821

ERGO™ Slotted/Phillips/Pozidriv Screwdriver Set with Rubber Grip - 6 Pcs



**BE-9886**

6 1 BE-9886

BE-8030  
BE-8150  
BE-8621, BE-8611  
BE-8821, BE-8811

ERGO™ Slotted/Phillips/Pozidriv/TORX® Screwdriver Set with Rubber Grip - 6 Pcs



ergo®



**BE-9871**



6

1 BE-9871

|                  |  |  |
|------------------|--|--|
| BE-8220S         |  |  |
| BE-8920, BE-8925 |  |  |
| BE-8820          |  |  |
| BE-8611, BE-8620 |  |  |

ERGO™ Slotted/Phillips/Pozidriv/Torx® Screwdriver Set with Rubber Grip - 8 pcs



ergo®



**BE-9872**

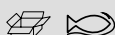

8

45 x 170 x 340 mm

595 g

1 BE-9872

|                           |  |  |
|---------------------------|--|--|
| BE-8925, BE-8920, BE-8915 |  |  |
| BE-8030                   |  |  |
| BE-8821, BE-8811          |  |  |
| BE-8621, BE-8611          |  |  |

ERGO™ Slotted/Phillips/Pozidriv/TORX® Screwdriver Set with Rubber Grip - 13 Pcs



ergo®



**BE-9875**



13

1 BE-9875

|                                    |  |  |
|------------------------------------|--|--|
| BE-8040                            |  |  |
| BE-8150, BE-8155                   |  |  |
| BE-8621                            |  |  |
| BE-8811, BE-8821                   |  |  |
| BE-8910, BE-8915, BE-8920, BE-8925 |  |  |
| BE-8010S, BE-8230S                 |  |  |
| BE-8811S                           |  |  |

ERGO™ Slotted/Phillips/Pozidriv/TORX® Screwdriver Set with Rubber Grip - 13 Pcs



ergo®



**BE-9879**



13

1 BE-9879

|                                    |  |  |
|------------------------------------|--|--|
| BE-8010, BE-8040                   |  |  |
| BE-8150                            |  |  |
| BE-8611, BE-8621                   |  |  |
| BE-8811, BE-8821                   |  |  |
| BE-8910, BE-8915, BE-8920, BE-8925 |  |  |
| BE-8220SL                          |  |  |
| BE-8620SL                          |  |  |



ERGO™ Slotted/Phillips/Pozidriv/TORX® Screwdriver Set with Rubber Grip - 15 Pcs



**BE-9877**



15

1 BE-9877

|                                    |  |  |
|------------------------------------|--|--|
| BE-8030                            |  |  |
| BE-8150                            |  |  |
| BE-8611, BE-8621                   |  |  |
| BE-8811, BE-8821                   |  |  |
| BE-8910, BE-8915, BE-8920, BE-8925 |  |  |
| BE-8220S, BE-8040S, BE-8050S       |  |  |
| BE-8611S, BE-8621S                 |  |  |

ERGO™ Slotted Straight Screwdrivers with Rubber Grip 2.0-6.5 mm



**BE-8002 - BE-8252**



| Tip Size | Length | Shaft Length | Quantity | Part Number |
|----------|--------|--------------|----------|-------------|
| 2.0 mm   | 60 mm  | 17 mm        | 5        | BE-8002     |
| 2.5 mm   | 60 mm  | 17 mm        | 5        | BE-8010     |
| 2.5 mm   | 75 mm  | 17 mm        | 5        | BE-8210     |
| 3.0 mm   | 60 mm  | 17 mm        | 5        | BE-8020     |
| 3.0 mm   | 75 mm  | 17 mm        | 5        | BE-8020L    |
| 3.0 mm   | 100 mm | 17 mm        | 5        | BE-8022     |
| 3.0 mm   | 125 mm | 17 mm        | 5        | BE-8220     |
| 3.0 mm   | 200 mm | 17 mm        | 5        | BE-8225     |
| 3.5 mm   | 75 mm  | 17 mm        | 5        | BE-8030     |
| 3.5 mm   | 125 mm | 17 mm        | 5        | BE-8230     |
| 3.5 mm   | 200 mm | 17 mm        | 5        | BE-8235     |
| 4.0 mm   | 100 mm | 20 mm        | 5        | BE-8040     |
| 4.0 mm   | 175 mm | 20 mm        | 5        | BE-8240     |
| 5.5 mm   | 125 mm | 27 mm        | 5        | BE-8241     |
| 5.5 mm   | 150 mm | 27 mm        | 5        | BE-8242     |
| 5.5 mm   | 200 mm | 27 mm        | 5        | BE-8250L    |
| 6.0 mm   | 150 mm | 36 mm        | 5        | BE-8251     |
| 6.5 mm   | 150 mm | 36 mm        | 5        | BE-8252     |

ERGO™ Slotted Flat Screwdrivers with Rubber Grip 5.5-10 mm



**BE-8150 - BE-8258**

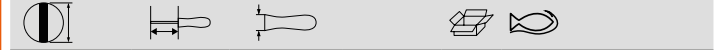

| Tip Size | Length | Shaft Length | Quantity | Part Number |
|----------|--------|--------------|----------|-------------|
| 5.5 mm   | 100 mm | 27 mm        | 5        | BE-8150     |
| 5.5 mm   | 150 mm | 27 mm        | 5        | BE-8250     |
| 6.5 mm   | 125 mm | 36 mm        | 5        | BE-8155     |
| 6.5 mm   | 150 mm | 36 mm        | 5        | BE-8255     |
| 8 mm     | 150 mm | 36 mm        | 5        | BE-8256     |
| 8 mm     | 175 mm | 36 mm        | 5        | BE-8257     |
| 10 mm    | 200 mm | 36 mm        | 5        | BE-8258     |

ERGO™ Hex Bolster Slotted Flat Screwdrivers with Rubber Grip 5.5-8 mm



**BE-8158 - BE-8890**

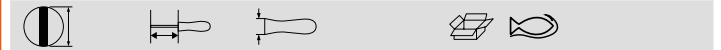

| Tip Size | Length | Shaft Length | Quantity | Part Number |
|----------|--------|--------------|----------|-------------|
| 5.5 mm   | 125 mm | 27 mm        | 5        | BE-8158     |
| 6.5 mm   | 150 mm | 36 mm        | 5        | BE-8159     |
| 8 mm     | 125 mm | 36 mm        | 5        | BE-8160     |
| 8 mm     | 175 mm | 36 mm        | 5        | BE-8260     |
| 8 mm     | 175 mm | 36 mm        | 5        | BE-8865     |
| 10 mm    | 175 mm | 36 mm        | 5        | BE-8870     |
| 12 mm    | 200 mm | 36 mm        | 5        | BE-8880     |
| 14 mm    | 200 mm | 36 mm        | 5        | BE-8890     |

ERGO™ Stubby Slotted Straight Screwdrivers with Rubber Grip 3.5-8.0 mm



**BE-8330 - BE-8360**



| Tip Size | Length | Shaft Length | Quantity | Part Number |
|----------|--------|--------------|----------|-------------|
| 3.5 mm   | 25 mm  | 36 mm        | 5        | BE-8330     |
| 4.0 mm   | 25 mm  | 36 mm        | 5        | BE-8340     |
| 5.0 mm   | 25 mm  | 36 mm        | 5        | BE-8350     |
| 5.0 mm   | 45 mm  | 36 mm        | 5        | BE-8450     |



| Tip Size | Length | Shaft Diameter | Weight | Part No. |
|----------|--------|----------------|--------|----------|
| 6.5 mm   | 25 mm  | 36 mm          | 5      | BE-8355  |
| 6.0 mm   | 45 mm  | 36 mm          | 5      | BE-8455  |
| 8.0 mm   | 25 mm  | 36 mm          | 5      | BE-8360  |

### ERGO™ Phillips Screwdrivers with Rubber Grip PH0-PH4



### BE-8600 - BE-8624



| Tip  | Length   | Shaft Diameter | Weight | Part No. |
|------|----------|----------------|--------|----------|
| PH 0 | 60 mm    | 17 mm          | 5      | BE-8600  |
| PH 0 | 100 mm   | 17 mm          | 5      | BE-8605  |
| PH 0 | 200 mm   | 17 mm          | 5      | BE-8608  |
| PH 1 | 75 mm    | 27 mm          | 5      | BE-8610  |
| PH 1 | 75 mm    | 20 mm          | 5      | BE-8611  |
| PH 1 | * 200 mm | 27 mm          | 5      | BE-8610L |
| PH 2 | 100 mm   | 36 mm          | 5      | BE-8620  |
| PH 2 | 100 mm   | 27 mm          | 5      | BE-8621  |
| PH 2 | 150 mm   | 36 mm          | 5      | BE-8622  |
| PH 2 | * 200 mm | 36 mm          | 5      | BE-8620L |
| PH 3 | 150 mm   | 36 mm          | 5      | BE-8623  |
| PH 4 | 200 mm   | 36 mm          | 5      | BE-8624  |

### ERGO™ Hex Bolster Phillips Screwdrivers with Rubber Grip PH1-PH4



### BE-8628 - BE-8640



| Tip  | Length | Shaft Diameter | Weight | Part No. |
|------|--------|----------------|--------|----------|
| PH 1 | 100 mm | 27 mm          | 5      | BE-8628  |
| PH 2 | 125 mm | 36 mm          | 5      | BE-8629  |
| PH 3 | 150 mm | 36 mm          | 5      | BE-8630  |
| PH 4 | 200 mm | 36 mm          | 5      | BE-8640  |

### ERGO™ Stubby Phillips Screwdrivers with Rubber Grip PH1-PH2



### BE-8601/BE-8602



| Tip  | Length | Shaft Diameter | Weight | Part No. |
|------|--------|----------------|--------|----------|
| PH 1 | 25 mm  | 36 mm          | 5      | BE-8601  |
| PH 2 | 25 mm  | 36 mm          | 5      | BE-8602  |

### ERGO™ Pozidriv Screwdrivers with Rubber Grip PZ0-PZ4



### BE-8800 - BE-8824



| Tip  | Length | Shaft Diameter | Weight | Part No. |
|------|--------|----------------|--------|----------|
| PZ 0 | 60 mm  | 17 mm          | 5      | BE-8800  |
| PZ 1 | 75 mm  | 27 mm          | 5      | BE-8810  |
| PZ 1 | 75 mm  | 20 mm          | 5      | BE-8811  |
| PZ 1 | 200 mm | 27 mm          | 5      | BE-8810L |
| PZ 2 | 100 mm | 36 mm          | 5      | BE-8820  |
| PZ 2 | 100 mm | 27 mm          | 5      | BE-8821  |
| PZ 2 | 200 mm | 36 mm          | 5      | BE-8820L |
| PZ 3 | 150 mm | 36 mm          | 5      | BE-8823  |
| PZ 4 | 200 mm | 36 mm          | 5      | BE-8824  |

### ERGO™ Hex Bolster Pozidriv Screwdrivers with Rubber Grip PZ1-PZ4

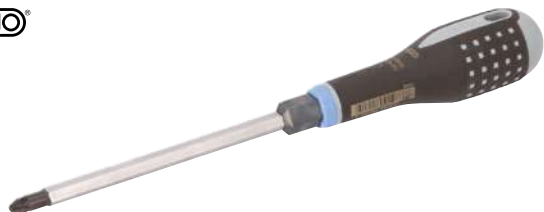

### BE-8828 - BE-8840



| Tip  | Length | Shaft Diameter | Weight | Part No. |
|------|--------|----------------|--------|----------|
| PZ 1 | 100 mm | 27 mm          | 5      | BE-8828  |
| PZ 2 | 125 mm | 36 mm          | 5      | BE-8829  |
| PZ 3 | 150 mm | 36 mm          | 5      | BE-8830  |
| PZ 4 | 200 mm | 36 mm          | 5      | BE-8840  |



ERGO™ Stubby Pozidriv Screwdrivers with Rubber Grip PZ1-PZ2



**BE-8801/BE-8802**



| PZ 1 | 25 mm | 36 mm | 5 | BE-8801 |
|------|-------|-------|---|---------|
| PZ 2 | 25 mm | 36 mm | 5 | BE-8802 |

ERGO™ TORX® Screwdrivers with Rubber Grip T4-T45



**BE-8904 - BE-8945**



| T 4  | 75 mm  | 17 mm | 5 | BE-8904 |
|------|--------|-------|---|---------|
| T 5  | 75 mm  | 17 mm | 5 | BE-8905 |
| T 6  | 75 mm  | 17 mm | 5 | BE-8906 |
| T 7  | 75 mm  | 17 mm | 5 | BE-8907 |
| T 8  | 75 mm  | 17 mm | 5 | BE-8908 |
| T 9  | 75 mm  | 17 mm | 5 | BE-8909 |
| T 10 | 75 mm  | 20 mm | 5 | BE-8910 |
| T 15 | 100 mm | 27 mm | 5 | BE-8915 |
| T 20 | 100 mm | 27 mm | 5 | BE-8920 |
| T 25 | 125 mm | 27 mm | 5 | BE-8925 |
| T 27 | 125 mm | 27 mm | 5 | BE-8927 |
| T30  | 150 mm | 36 mm | 5 | BE-8930 |
| T40  | 150 mm | 36 mm | 5 | BE-8940 |
| T45  | 150 mm | 36 mm | 5 | BE-8945 |

ERGO™ TORX® Tamper-Resistant Screwdrivers with Rubber Grip TR7-TR40



**BE-7907 - BE-7940**



| TR 7 | 75 mm | 17 mm | 5 | BE-7907 |
|------|-------|-------|---|---------|
| TR 8 | 75 mm | 17 mm | 5 | BE-7908 |
| TR 9 | 75 mm | 17 mm | 5 | BE-7909 |

| TR 10 | 75 mm  | 20 mm | 5 | BE-7910 |
|-------|--------|-------|---|---------|
| TR 15 | 100 mm | 27 mm | 5 | BE-7915 |
| TR 20 | 100 mm | 27 mm | 5 | BE-7920 |
| TR 25 | 125 mm | 27 mm | 5 | BE-7925 |
| TR 27 | 125 mm | 27 mm | 5 | BE-7927 |
| TR 30 | 150 mm | 36 mm | 5 | BE-7930 |
| TR 40 | 150 mm | 36 mm | 5 | BE-7940 |

ERGO™ TORX® Ball End Screwdrivers with Rubber Grip T15-T40



**BE-7515 - BE-7540**



| T 15 | 100 mm | 27 mm | 5 | BE-7515 |
|------|--------|-------|---|---------|
| T 20 | 100 mm | 27 mm | 5 | BE-7520 |
| T 25 | 125 mm | 27 mm | 5 | BE-7525 |
| T 27 | 125 mm | 27 mm | 5 | BE-7527 |
| T 30 | 150 mm | 36 mm | 5 | BE-7530 |
| T 40 | 150 mm | 36 mm | 5 | BE-7540 |

ERGO™ TORX® Plus Screwdrivers with Rubber Grip T15-T40



**BE-7715 - BE-7740**



| T 15 | 100 mm | 27 mm | 5 | BE-7715 |
|------|--------|-------|---|---------|
| T 20 | 100 mm | 27 mm | 5 | BE-7720 |
| T 25 | 125 mm | 27 mm | 5 | BE-7725 |
| T 27 | 125 mm | 27 mm | 5 | BE-7727 |
| T 30 | 150 mm | 36 mm | 5 | BE-7730 |
| T 40 | 150 mm | 36 mm | 5 | BE-7740 |

ERGO™ Hex Screwdrivers with Rubber Grip Hex2-3 mm



**BE-6902 - BE-6903**



| Hex Size | Length | Tip Length | Quantity | Part No. |
|----------|--------|------------|----------|----------|
| 2 mm     | 75 mm  | 17 mm      | 5        | BE-6902  |
| 2.5 mm   | 75 mm  | 17 mm      | 5        | BE-6925  |
| 3 mm     | 75 mm  | 20 mm      | 5        | BE-6903  |

ERGO™ Robertson -Square Screwdrivers with Rubber Grip #1-#3



**BE-9001 - BE-9003**



| Size | Length | Tip Length | Quantity | Part No. |
|------|--------|------------|----------|----------|
| # 1  | 80 mm  | 27 mm      | 5        | BE-9001  |
| # 2  | 80 mm  | 27 mm      | 5        | BE-9002  |
| # 3  | 100 mm | 27 mm      | 5        | BE-9003  |

ERGO™ Hex Ball End Screwdrivers with Rubber Grip, metric 1.5-10 mm



**BE-8715 - BE-8710**



| Hex Size | Length | Tip Length | Quantity | Part No. |
|----------|--------|------------|----------|----------|
| 1.5 mm   | 60 mm  | 17 mm      | 5        | BE-8715  |
| 2 mm     | 100 mm | 17 mm      | 5        | BE-8702  |
| 2.5 mm   | 100 mm | 17 mm      | 5        | BE-8725  |
| 3 mm     | 100 mm | 20 mm      | 5        | BE-8703  |
| 4 mm     | 100 mm | 27 mm      | 5        | BE-8704  |
| 5 mm     | 100 mm | 36 mm      | 5        | BE-8705  |
| 6 mm     | 125 mm | 36 mm      | 5        | BE-8706  |
| 8 mm     | 150 mm | 36 mm      | 5        | BE-8708  |
| 10 mm    | 150 mm | 36 mm      | 5        | BE-8710  |

ERGO™ TRI-WING® Security Screwdrivers with Rubber Grip #0-#5



**BE-9100 - BE-9105**



| Size | Length | Tip Length | Quantity | Part No. |
|------|--------|------------|----------|----------|
| 0    | 80 mm  | 20 mm      | 5        | BE-9100  |
| 1    | 80 mm  | 20 mm      | 5        | BE-9101  |
| 2    | 80 mm  | 27 mm      | 5        | BE-9102  |
| 3    | 80 mm  | 27 mm      | 5        | BE-9103  |
| 4    | 100 mm | 27 mm      | 5        | BE-9104  |
| 5    | 100 mm | 27 mm      | 5        | BE-9105  |

ERGO™ Hex Ball End Screwdrivers with Rubber Grip, inches 7/64-3/8"



**BE-8700-7/64 - BE-8700-5/16**



| Hex Size | Length | Tip Length | Quantity | Part No.     |
|----------|--------|------------|----------|--------------|
| 7/64 in  | 100 mm | 20 mm      | 5        | BE-8700-7/64 |
| 5/32 in  | 100 mm | 27 mm      | 5        | BE-8700-5/32 |
| 3/16 in  | 100 mm | 27 mm      | 5        | BE-8700-3/16 |
| 7/32 in  | 100 mm | 36 mm      | 5        | BE-8700-7/32 |
| 1/4 in   | 125 mm | 36 mm      | 5        | BE-8700-1/4  |
| 5/16 in  | 150 mm | 36 mm      | 5        | BE-8700-5/16 |
| 3/8 in   | 150 mm | 36 mm      | 5        | BE-8700-3/8  |

ERGO™ TORQ-SET® Security Screwdrivers with Rubber Grip #1-#10



**BE-8080**



| Size | Length | Tip Length | Quantity | Part No.   |
|------|--------|------------|----------|------------|
| 1    | 75 mm  | 27 mm      | 5        | BE-8080-1  |
| 2    | 75 mm  | 27 mm      | 5        | BE-8080-2  |
| 3    | 75 mm  | 27 mm      | 5        | BE-8080-3  |
| 4    | 75 mm  | 27 mm      | 5        | BE-8080-4  |
| 5    | 75 mm  | 27 mm      | 5        | BE-8080-5  |
| 6    | 75 mm  | 27 mm      | 5        | BE-8080-6  |
| 8    | 100 mm | 27 mm      | 5        | BE-8080-8  |
| 10   | 100 mm | 27 mm      | 5        | BE-8080-10 |



ERGO™ Round Tip Awl Screwdriver with Rubber Grip



**BE-8985**

|      |        |       |   |         |
|------|--------|-------|---|---------|
|      |        |       |   |         |
| 6 mm | 100 mm | 27 mm | 5 | BE-8985 |

ERGO™ Stubby Round Tip Awl Screwdriver with Rubber Grip 6 mm



**BE-8986**

|      |       |       |   |         |
|------|-------|-------|---|---------|
|      |       |       |   |         |
| 4 mm | 36 mm | 50 mm | 5 | BE-8986 |

ERGO™ Square Tip Reamer Screwdriver with Rubber Grip 6 mm



**BE-8980**

|      |        |       |   |         |
|------|--------|-------|---|---------|
|      |        |       |   |         |
| 6 mm | 100 mm | 27 mm | 5 | BE-8980 |

ERGO™ Hex Head Nut Drivers with Rubber Grip 4-7 mm



**BE-6400M**

|        |       |       |   |              |
|--------|-------|-------|---|--------------|
|        |       |       |   |              |
| 4 mm   | 75 mm | 20 mm | 5 | BE-6400M-4   |
| 5 mm   | 75 mm | 20 mm | 5 | BE-6400M-5   |
| 5.5 mm | 75 mm | 20 mm | 5 | BE-6400M-5.5 |
| 7 mm   | 75 mm | 20 mm | 5 | BE-6400M-7   |

ERGO™ Long Bore Hex Head Nut Drivers with Rubber Grip 3-14 mm



**BE-78**

|        |        |       |   |         |
|--------|--------|-------|---|---------|
|        |        |       |   |         |
| 3 mm   | 125 mm | 20 mm | 5 | BE-7803 |
| 3.5 mm | 125 mm | 20 mm | 5 | BE-7835 |
| 4 mm   | 125 mm | 20 mm | 5 | BE-7804 |
| 4.5 mm | 125 mm | 20 mm | 5 | BE-7845 |
| 5 mm   | 125 mm | 20 mm | 5 | BE-7805 |
| 5.5 mm | 125 mm | 20 mm | 5 | BE-7855 |
| 6 mm   | 125 mm | 20 mm | 5 | BE-7806 |
| 7 mm   | 125 mm | 27 mm | 5 | BE-7807 |
| 8 mm   | 125 mm | 27 mm | 5 | BE-7808 |
| 9 mm   | 125 mm | 36 mm | 5 | BE-7809 |
| 10 mm  | 125 mm | 36 mm | 5 | BE-7810 |
| 11 mm  | 125 mm | 36 mm | 5 | BE-7811 |
| 12 mm  | 125 mm | 36 mm | 5 | BE-7812 |
| 13 mm  | 125 mm | 36 mm | 5 | BE-7813 |
| 14 mm  | 125 mm | 36 mm | 5 | BE-7814 |

ERGO™ Flexible Shaft Hex Head Nut Drivers with Rubber Grip 6-8 mm



**BE-76**

| Hex Size | Length | Shaft Diameter | Quantity | Part No. |
|----------|--------|----------------|----------|----------|
| 6 mm     | 150 mm | 27 mm          | 5        | BE-7606  |
| 7 mm     | 150 mm | 27 mm          | 5        | BE-7607  |
| 8 mm     | 150 mm | 27 mm          | 5        | BE-7608  |

ERGO™ Bit Holder with Rubber Grip for 1/4" Hex Bit



**BE-8577**

| Hex Size | Length | Shaft Diameter | Quantity | Part No. |
|----------|--------|----------------|----------|----------|
| 1/4 in   | 118 mm | 36 mm          | 5        | BE-8577  |

ERGO™ Bit Holder Screwdriver with quick release system for 1/4" Hex Blades



**BE-8575**

| Hex Size | Length | Quantity | Part No. |
|----------|--------|----------|----------|
| 1/4 in   | 122 mm | 1        | BE-8575  |

1/4" Hex Blades for Slotted Head Screw - 100 mm



**8020-2P - 8252-2P**

| Hex Size | Thickness | Quantity | Part No. |
|----------|-----------|----------|----------|
| 3.0 mm   | 0.5 mm    | 1        | 8020-2P  |
| 3.5 mm   | 0.6 mm    | 1        | 8030-2P  |
| 4.0 mm   | 0.8 mm    | 1        | 8040-2P  |
| 5.5 mm   | 1.0 mm    | 1        | 8242-2P  |
| 6.5 mm   | 1.2 mm    | 1        | 8252-2P  |

1/4" Hex Blades for Phillips Head Screw - 100 mm



**8600-2P - 8630-2P**

| Hex Size | Quantity | Part No. |
|----------|----------|----------|
| 0        | 1        | 8600-2P  |
| 1        | 1        | 8610-2P  |
| 2        | 1        | 8620-2P  |
| 3        | 1        | 8630-2P  |

1/4" Hex Blades for Pozidriv Head Screw - 100 mm



**8800-2P - 8830-2P**

| Hex Size | Quantity | Part No. |
|----------|----------|----------|
| 0        | 1        | 8800-2P  |
| 1        | 1        | 8810-2P  |
| 2        | 1        | 8820-2P  |
| 3        | 1        | 8830-2P  |





1/4" Hex Blades for TORX® Head Screw - 100 mm



**8910-2P - 8940-2P**



| 10 | 1 | 8910-2P |  |
|----|---|---------|--|
| 15 | 1 | 8915-2P |  |
| 20 | 1 | 8920-2P |  |
| 25 | 1 | 8925-2P |  |
| 27 | 1 | 8927-2P |  |
| 30 | 1 | 8930-2P |  |
| 40 | 1 | 8940-2P |  |

1/4" Hex Blades for Phillips Head Screw - 300 mm



**8610L-2P - 8620L-2P**



| 1 | 1 | 8610L-2P |  |
|---|---|----------|--|
| 2 | 1 | 8620L-2P |  |

1/4" Hex Blades for Hex Ball Head Screw - 100 mm



**8703-2P - 8706-2P**



| 3 mm | 1 | 8703-2P |  |
|------|---|---------|--|
| 4 mm | 1 | 8704-2P |  |
| 5 mm | 1 | 8705-2P |  |
| 6 mm | 1 | 8706-2P |  |

1/4" Hex Blades for Pozidriv Head Screw - 300 mm



**8810L-2P - 8820L-2P**



| 1 | 1 | 8810L-2P |  |
|---|---|----------|--|
| 2 | 1 | 8820L-2P |  |

1/4" Hex Blades for Slotted Head Screw - 300 mm



**8040L-2P - 8252L-2P**



| 0.8 mm | 4.0 mm | 1 | 8040L-2P |
|--------|--------|---|----------|
| 1.0 mm | 5.5 mm | 1 | 8242L-2P |
| 1.2 mm | 6.5 mm | 1 | 8252L-2P |

1/4" Hex Blades for TORX® Head Screw - 300 mm



**8915L-2P - 8930L-2P**



| T15 | 1 | 8915L-2P |  |
|-----|---|----------|--|
| T20 | 1 | 8920L-2P |  |
| T25 | 1 | 8925L-2P |  |
| T27 | 1 | 8927L-2P |  |
| T30 | 1 | 8930L-2P |  |

1/4" Hex Blades for Phillips Head Screw - 400 mm



**8620XL-1P - 8252XL-1P**



|   |   |           |
|---|---|-----------|
| 2 | 1 | 8620XL-1P |
| 3 | 1 | 8630XL-1P |

1/4" Hex Blades for Pozidriv Head Screw - 400 mm



**8820XL-1P - 8830XL-1P**



|   |   |           |
|---|---|-----------|
| 2 | 1 | 8820XL-1P |
| 3 | 1 | 8830XL-1P |

1/4" Hex Blades for Slotted Head Screw - 400 mm



**8252XL-1P - 8256XL-1P**



|        |        |   |           |
|--------|--------|---|-----------|
| 1.2 mm | 6.5 mm | 1 | 8252XL-1P |
|--------|--------|---|-----------|

ERGO™ Bit Holder Screwdrivers with quick release system and Interchangeable Blades Set - 7 Pcs



**BE-8571**



|   |                  |   |         |
|---|------------------|---|---------|
| 7 | 85 x 85 x 210 mm | 1 | BE-8571 |
|---|------------------|---|---------|

|                  |  |  |
|------------------|--|--|
| BE-8575          |  |  |
| 8242-2P, 8252-2P |  |  |
| 8610-2P, 8620-2P |  |  |
| 8810-2P, 8820-2P |  |  |

ERGO™ Bit Holder Screwdriver with quick release system and Interchangeable Blades Set - 9 Pcs



**BE-8572**



|   |                  |   |         |
|---|------------------|---|---------|
| 9 | 85 x 80 x 210 mm | 1 | BE-8572 |
|---|------------------|---|---------|

|                  |  |  |
|------------------|--|--|
| BE-8575          |  |  |
| 8242-2P, 8252-2P |  |  |
| 8610-2P, 8620-2P |  |  |
| 8810-2P, 8820-2P |  |  |
| 8910-2P, 8915-2P |  |  |



ERGO™ Bit Holder Screwdrivers with quick release system and TORX® Interchangeable Blades Set - 8 Pcs



**BE-8573**



|   |                  |   |         |
|---|------------------|---|---------|
|   |                  |   |         |
| 8 | 85 x 85 x 210 mm | 1 | BE-8573 |

**BE-8575**

8910-2P, 8915-2P, 8920-2P, 8925-2P, 8927-2P, 8930-2P, 8940-2P

ERGO™ Bit Holder Screwdrivers with quick release bit holder and Interchangeable Blades Set - 8 Pcs



**BE-8574**



|   |                  |   |         |
|---|------------------|---|---------|
|   |                  |   |         |
| 8 | 85 x 85 x 210 mm | 1 | BE-8574 |

**BE-8575**

8610-2P, 8620-2P

8040-2P

8820-2P

8920-2P, 8925-2P, 8930-2P

ERGO™ Bit Holder Screwdriver with quick release system and Interchangeable Blades/Bits Set - 22 Pcs



**BE-8576**



|    |   |         |
|----|---|---------|
|    |   |         |
| 23 | 1 | BE-8576 |

**BE-8575**

8030-2P, 8040-2P, 8242-2P, 8252-2P

8810-2P, 8820-2P, 8830-2P

8610-2P, 8620-2P, 8630-2P

8910-2P, 8915-2P, 8925-2P, 8930-2P, 8940-2P

59S/H2, 59S/H3, 59S/H5, 59S/H4, 59S/H6

59S/H8

**ERGO™ SCREWDRIVERS WITH IMPACT GRIP**

ERGO™ Through Blade Slotted/Phillips/Hex Screwdriver Set with Impact Grip - 6 Pcs



**BE-9881TB**



|   |   |           |
|---|---|-----------|
|   |   |           |
| 6 | 1 | BE-9881TB |

BE-8135TB, BE-8145TB, BE-8150TB, BE-8155TB

BE-8610TB, BE-8620TB

ERGO™ Through Blade Slotted/Pozidriv/Hex Screwdriver Set with Impact Grip - 6 Pcs



**BE-9882TB**



6



1 BE-9882TB

BE-8135TB, BE-8145TB, BE-8150TB, BE-8155TB



BE-8810TB, BE-8820TB



ERGO™ Through Blade TORX®/Hex Screwdriver Set with Impact Grip - 5 Pcs



**BE-9885TB**



5



1 BE-9885TB

BE-8915TB, BE-8920TB, BE-8925TB, BE-8930TB, BE-8940TB



ERGO™ Through Blade Slotted Screwdrivers with Impact Grip 3.5-6.5 mm



**BE-8135TB - BE-8262TB**



3.5 mm



75 mm



27 mm



10 BE-8135TB

4.5 mm

100 mm

27 mm

10 BE-8145TB

5.5 mm

100 mm

27 mm

10 BE-8150TB

6.5 mm

125 mm

36 mm

5 BE-8155TB

| 8 mm   | 150 mm | 36 mm | 10 | 10 | BE-8256TB  |
|--------|--------|-------|----|----|------------|
| 10 mm  | 175 mm | 36 mm | 10 | 10 | BE-8258TB  |
| 12 mm  | 200 mm | 36 mm | 10 | 10 | BE-8262TB  |
| 3.5 mm | 75 mm  | 27 mm | 1  | 1  | SBE-8135TB |
| 4.5 mm | 100 mm | 27 mm | 1  | 1  | SBE-8145TB |
| 5.5 mm | 100 mm | 27 mm | 1  | 1  | SBE-8150TB |
| 6.5 mm | 125 mm | 36 mm | 1  | 1  | SBE-8155TB |

ERGO™ Through Blade Phillips Screwdrivers with Impact Grip PH1-PH4



**BE-8610TB - BE-8624TB**

| PH 1 | 100 mm | 27 mm | 10 | 10 | BE-8610TB  |
|------|--------|-------|----|----|------------|
| PH 2 | 125 mm | 36 mm | 10 | 10 | BE-8620TB  |
| PH 3 | 150 mm | 36 mm | 10 | 10 | BE-8623TB  |
| PH 4 | 175 mm | 36 mm | 10 | 10 | BE-8624TB  |
| PH 1 | 100 mm | 27 mm | 1  | 1  | SBE-8610TB |
| PH 2 | 125 mm | 36 mm | 1  | 1  | SBE-8620TB |

ERGO™ Through Blade Pozidriv Screwdrivers with Impact Grip PZ1-PZ4



**BE-8810TB - BE-8824TB**

| PZ 1 | 100 mm | 27 mm | 10 | 10 | BE-8810TB  |
|------|--------|-------|----|----|------------|
| PZ 2 | 125 mm | 36 mm | 10 | 10 | BE-8820TB  |
| PZ 3 | 150 mm | 36 mm | 10 | 10 | BE-8823TB  |
| PZ 4 | 175 mm | 36 mm | 10 | 10 | BE-8824TB  |
| PZ 1 | 100 mm | 27 mm | 1  | 1  | SBE-8810TB |
| PZ 2 | 125 mm | 36 mm | 1  | 1  | SBE-8820TB |



ERGO™ Through Blade TORX® Screwdrivers with Impact Grip T10-T40



**BE-8910TB - BE-8940TB**

| T 10 | 75 mm  | 27 mm | 5 | 5 | 5 | 5 | 5 |
|------|--------|-------|---|---|---|---|---|
| T 15 | 100 mm | 27 mm | 5 | 5 | 5 | 5 | 5 |
| T 20 | 100 mm | 27 mm | 5 | 5 | 5 | 5 | 5 |
| T 25 | 100 mm | 27 mm | 5 | 5 | 5 | 5 | 5 |
| T 27 | 125 mm | 27 mm | 5 | 5 | 5 | 5 | 5 |
| T 30 | 150 mm | 36 mm | 5 | 5 | 5 | 5 | 5 |
| T 40 | 150 mm | 36 mm | 5 | 5 | 5 | 5 | 5 |
| T 15 | 100 mm | 27 mm | 1 | 1 | 1 | 1 | 1 |
| T 20 | 100 mm | 27 mm | 1 | 1 | 1 | 1 | 1 |
| T 25 | 100 mm | 27 mm | 1 | 1 | 1 | 1 | 1 |
| T 30 | 150 mm | 36 mm | 1 | 1 | 1 | 1 | 1 |
| T 40 | 150 mm | 36 mm | 1 | 1 | 1 | 1 | 1 |

**BAHCOFIT SCREWDRIVERS WITH GROOVED RUBBER GRIP**

BahcoFit Slotted/Phillips Screwdriver Set with Rubber Grip - 2 Pcs



**B219.002**

|  |  |  |   |   |          |
|--|--|--|---|---|----------|
|  |  |  | 2 | 1 | B219.002 |
|--|--|--|---|---|----------|

|              |  |  |  |  |  |  |  |
|--------------|--|--|--|--|--|--|--|
| B191.040.100 |  |  |  |  |  |  |  |
| B192.001.100 |  |  |  |  |  |  |  |

BahcoFit Slotted/Phillips Screwdriver Set with Rubber Grip - 2 Pcs



**B219.012**

|  |  |  |   |   |          |
|--|--|--|---|---|----------|
|  |  |  | 2 | 1 | B219.012 |
|--|--|--|---|---|----------|

**BAHCO**

|              |  |  |  |  |  |  |  |
|--------------|--|--|--|--|--|--|--|
| B190.055.125 |  |  |  |  |  |  |  |
| B192.002.125 |  |  |  |  |  |  |  |

BahcoFit Slotted/Phillips Screwdriver Set with Rubber Grip - 4 Pcs



**B219.004**

|  |  |  |   |   |          |
|--|--|--|---|---|----------|
|  |  |  | 4 | 1 | B219.004 |
|--|--|--|---|---|----------|

|                            |  |  |  |  |  |  |  |
|----------------------------|--|--|--|--|--|--|--|
| B191.030.100, B191.055.125 |  |  |  |  |  |  |  |
| B192.001.100, B192.002.125 |  |  |  |  |  |  |  |

BahcoFit Phillips Screwdriver Set with Rubber Grip - 4 Pcs



**B219.014**

|  |  |  |   |   |          |
|--|--|--|---|---|----------|
|  |  |  | 4 | 1 | B219.014 |
|--|--|--|---|---|----------|

|  |  |  |  |  |  |  |  |
|--|--|--|--|--|--|--|--|
| B192.000.075, B192.001.100, B192.002.125, B192.003.150 |  |  |  |  |  |  |  |
|--|--|--|--|--|--|--|--|



BahcoFit Slotted/Phillips Screwdriver Set with Rubber Grip - 5 Pcs



**B219.005**



5

1 B219.005

B191.030.075, B191.040.100



B190.055.125



B192.001.100, B192.002.125



BahcoFit Slotted/Pozidriv Screwdriver Set with Rubber Grip - 5 Pcs



**B219.015**



5

1 B219.015

B191.030.075, B191.040.100



B190.055.125



B193.001.100, B193.002.125



BahcoFit TORX® Screwdriver Set with Rubber Grip - 5 Pcs



**B219.025**



5

1 B219.025

B194.010.075, B194.015.100, B194.020.100, B194.025.125,  
B194.030.150



BahcoFit Tamper-Resistant TORX® Screwdriver Set with Rubber Grip - 5 Pcs



**B219.035**



5

1 B219.035

B141.010.075, B141.015.100, B141.020.100, B141.025.125,  
B141.030.150



BahcoFit Slotted Screwdriver Set with Rubber Grip - 5 Pcs



**B219.045**



5

1 B219.045

B191.030.100, B191.040.125



B190.055.125, B190.065.150, B190.080.175



BahcoFit Slotted/Phillips Screwdriver Set with Rubber Grip - 6 Pcs



**B219.006**



6

1 B219.006

B191.030.075, B191.040.100



B190.055.125, B190.065.125



B192.001.100, B192.002.125



BahcoFit Slotted/Pozidriv Screwdriver Set with Rubber Grip - 6 Pcs



**B219.016**



6

1 B219.016

B191.030.075, B191.040.100



B190.055.125, B190.065.125



B193.001.100, B193.002.125



BahcoFit Slotted/Phillips/Pozidriv Screwdriver Set with Rubber Grip - 6 Pcs



**B219.026**



6

1 B219.026

B191.030.075, B191.040.100



B192.001.100, B192.002.125



B193.001.100, B193.002.125



BahcoFit Pozidriv/TORX® Screwdriver Set with Rubber Grip - 7 Pcs



**B219.007**

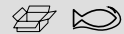

7

1 B219.007

B193.001.100, B193.002.125



B194.010.075, B194.015.100, B194.020.100, B194.025.125,  
B194.030.150



BahcoFit Slotted/Phillips Screwdriver Set with Rubber Grip - 7 Pcs



**B219.017**



7

1 B219.017

B191.035.100, B191.040.100



B190.055.125, B190.065.150, B190.080.150

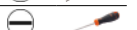

B192.001.100, B192.002.125



BahcoFit TORX® Screwdriver Set with Rubber Grip - 7 Pcs



**B219.027**



7

1 B219.027

B194.010.075, B194.015.100, B194.020.100, B194.025.125,  
B194.027.125, B194.030.150, B194.040.150



BahcoFit Slotted/Phillips Screwdriver Set with Rubber Grip - 8 Pcs



**B219.008**



8

1 B219.008

B191.040.100, B191.055.125



B190.065.150, B190.080.175



B192.001.100, B192.002.125



B195.060.025



B195.002.025



BahcoFit Slotted/Phillips/Pozidriv/TORX® Screwdriver Set with Rubber Grip - 10 Pcs



**B219.110**



10

1 B219.110

B190.055.100



B192.002.125



B193.002.125



B194.010.075, B194.015.100, B194.020.100



B196.025.075, B196.040.100



B142.001.080



806-1-1



BahcoFit Torx® Screwdriver Set with Rubber Grip - 10 pcs



**B219.210**



10

4.5 x 33 x 17 mm

1 B219.210

B194.006.075, B194.008.075, B194.009.075, B194.010.075,  
B194.015.100, B194.020.100, B194.025.125, B194.027.125,  
B194.030.150, B194.040.150



BahcoFit Slotted/Phillips/Pozidriv/Robertson Screwdriver Set with Rubber Grip - 10 Pcs



**B219.010**



10 1 B219.010

|  |  |  |
|--|--|--|
| B191.030.075                             |  |  |
| B190.055.100, B190.065.125, B190.080.150 |  |  |
| B192.001.100, B192.002.125, B192.003.150 |  |  |
| B195.902.025                             |  |  |
| B144.001.100, B144.002.125               |  |  |

BahcoFit Slotted Flat Screwdrivers with Rubber Grip 4.0-14 mm



**B190**

| Bit Size | Length | Tip Length | Quantity | Part Number   |
|----------|--------|------------|----------|---------------|
| 4 mm     | 75 mm  | 24.5 mm    | 10       | B190.040.075  |
| 4 mm     | 100 mm | 24.5 mm    | 10       | B190.040.100  |
| 5.5 mm   | 100 mm | 30 mm      | 10       | B190.055.100  |
| 5.5 mm   | 125 mm | 30 mm      | 10       | B190.055.125  |
| 6.5 mm   | 125 mm | 34 mm      | 10       | B190.065.125  |
| 6.5 mm   | 150 mm | 34 mm      | 10       | B190.065.150  |
| 8 mm     | 150 mm | 34 mm      | 10       | B190.080.150  |
| 8 mm     | 175 mm | 34 mm      | 10       | B190.080.175  |
| 10 mm    | 200 mm | 34 mm      | 10       | B190.100.200  |
| 12 mm    | 250 mm | 34 mm      | 10       | B190.120.250  |
| 14 mm    | 250 mm | 34 mm      | 10       | B190.140.250  |
| 4 mm     | 75 mm  | 24.5 mm    | 1        | SB190.040.075 |
| 4 mm     | 100 mm | 24.5 mm    | 1        | SB190.040.100 |
| 5.5 mm   | 100 mm | 30 mm      | 1        | SB190.055.100 |
| 5.5 mm   | 125 mm | 30 mm      | 1        | SB190.055.125 |
| 6.5 mm   | 125 mm | 34 mm      | 1        | SB190.065.125 |
| 6.5 mm   | 150 mm | 34 mm      | 1        | SB190.065.150 |
| 8 mm     | 150 mm | 34 mm      | 1        | SB190.080.150 |
| 8 mm     | 175 mm | 34 mm      | 1        | SB190.080.175 |
| 10 mm    | 200 mm | 34 mm      | 1        | SB190.100.200 |
| 12 mm    | 250 mm | 34 mm      | 1        | SB190.120.250 |
| 14 mm    | 250 mm | 34 mm      | 1        | SB190.140.250 |

BahcoFit Slotted Straight Screwdrivers with Rubber Grip 2.5-6.5 mm



**B191**

| Bit Size | Length | Tip Length | Quantity | Part Number   |
|----------|--------|------------|----------|---------------|
| 2.5 mm   | 75 mm  | 24.5 mm    | 10       | B191.025.075  |
| 3 mm     | 75 mm  | 24.5 mm    | 10       | B191.030.075  |
| 3 mm     | 100 mm | 24.5 mm    | 10       | B191.030.100  |
| 3 mm     | 200 mm | 24.5 mm    | 10       | B191.030.200  |
| 3.5 mm   | 100 mm | 24.5 mm    | 10       | B191.035.100  |
| 4 mm     | 100 mm | 24.5 mm    | 10       | B191.040.100  |
| 4 mm     | 125 mm | 24.5 mm    | 10       | B191.040.125  |
| 4 mm     | 250 mm | 24.5 mm    | 10       | B191.040.250  |
| 5.5 mm   | 125 mm | 30 mm      | 10       | B191.055.125  |
| 5.5 mm   | 150 mm | 30 mm      | 10       | B191.055.150  |
| 5.5 mm   | 300 mm | 30 mm      | 10       | B191.055.300  |
| 6.5 mm   | 150 mm | 34 mm      | 10       | B191.065.150  |
| 6.5 mm   | 300 mm | 34 mm      | 10       | B191.065.300  |
| 2.5 mm   | 75 mm  | 24.5 mm    | 1        | SB191.025.075 |
| 3 mm     | 75 mm  | 24.5 mm    | 1        | SB191.030.075 |
| 3 mm     | 100 mm | 24.5 mm    | 1        | SB191.030.100 |
| 3 mm     | 200 mm | 24.5 mm    | 1        | SB191.030.200 |
| 3.5 mm   | 100 mm | 24.5 mm    | 1        | SB191.035.100 |
| 4 mm     | 100 mm | 24.5 mm    | 1        | SB191.040.100 |
| 4 mm     | 125 mm | 24.5 mm    | 1        | SB191.040.125 |
| 4 mm     | 250 mm | 24.5 mm    | 1        | SB191.040.250 |
| 5.5 mm   | 125 mm | 30 mm      | 1        | SB191.055.125 |
| 5.5 mm   | 150 mm | 30 mm      | 1        | SB191.055.150 |
| 5.5 mm   | 300 mm | 30 mm      | 1        | SB191.055.300 |
| 6.5 mm   | 150 mm | 34 mm      | 1        | SB191.065.150 |
| 6.5 mm   | 300 mm | 34 mm      | 1        | SB191.065.300 |

BahcoFit Stubby Slotted Straight Screwdrivers with Rubber Grip 4.0-6.0 mm



**B195**

| Bit Size | Length | Tip Length | Quantity | Part Number   |
|----------|--------|------------|----------|---------------|
| 4 mm     | 25 mm  | 33 mm      | 10       | B195.040.025  |
| 5.0 mm   | 25 mm  | 33 mm      | 10       | B195.050.025  |
| 6 mm     | 25 mm  | 33 mm      | 10       | B195.060.025  |
| 4 mm     | 25 mm  | 33 mm      | 1        | SB195.040.025 |
| 5 mm     | 25 mm  | 33 mm      | 1        | SB195.050.025 |
| 6 mm     | 25 mm  | 33 mm      | 1        | SB195.060.025 |

### BahcoFit Phillips Screwdrivers with Rubber Grip PH0-PH4



#### B192



| PH0 | 75 mm  | 24.5 mm | 10 | B192.000.075  |
|-----|--------|---------|----|---------------|
| PH0 | 200 mm | 24.5 mm | 10 | B192.000.200  |
| PH1 | 100 mm | 30 mm   | 10 | B192.001.100  |
| PH1 | 250 mm | 30 mm   | 10 | B192.001.250  |
| PH2 | 125 mm | 34 mm   | 10 | B192.002.125  |
| PH2 | 150 mm | 34 mm   | 10 | B192.002.150  |
| PH2 | 300 mm | 34 mm   | 10 | B192.002.300  |
| PH3 | 150 mm | 34 mm   | 10 | B192.003.150  |
| PH4 | 200 mm | 34 mm   | 10 | B192.004.200  |
| PH0 | 75 mm  | 24.5 mm | 1  | SB192.000.075 |
| PH0 | 200 mm | 24.5 mm | 1  | SB192.000.200 |
| PH1 | 100 mm | 30 mm   | 1  | SB192.001.100 |
| PH1 | 250 mm | 30 mm   | 1  | SB192.001.250 |
| PH2 | 125 mm | 34 mm   | 1  | SB192.002.125 |
| PH2 | 300 mm | 34 mm   | 1  | SB192.002.300 |
| PH3 | 150 mm | 34 mm   | 1  | SB192.003.150 |
| PH4 | 200 mm | 34 mm   | 1  | SB192.004.200 |

### BahcoFit Stubby Phillips Screwdrivers with Rubber Grip PH1-PH2



#### B195PH



| PH1 | 25 mm | 33 mm | 10 | B195.001.025  |
|-----|-------|-------|----|---------------|
| PH2 | 25 mm | 33 mm | 10 | B195.002.025  |
| PH1 | 25 mm | 33 mm | 1  | SB195.001.025 |
| PH2 | 25 mm | 33 mm | 1  | SB195.002.025 |

### BahcoFit Pozidriv Screwdrivers with Rubber Grip PZ0-PZ4



#### B193



| PZ0 | 75 mm  | 24.5 mm | 10 | B193.000.075  |
|-----|--------|---------|----|---------------|
| PZ1 | 100 mm | 30 mm   | 10 | B193.001.100  |
| PZ2 | 125 mm | 34 mm   | 10 | B193.002.125  |
| PZ3 | 150 mm | 34 mm   | 10 | B193.003.150  |
| PZ4 | 200 mm | 34 mm   | 10 | B193.004.200  |
| PZ0 | 75 mm  | 24.5 mm | 1  | SB193.000.075 |
| PZ1 | 100 mm | 30 mm   | 1  | SB193.001.100 |
| PZ2 | 125 mm | 34 mm   | 1  | SB193.002.125 |
| PZ3 | 150 mm | 34 mm   | 1  | SB193.003.150 |
| PZ4 | 200 mm | 34 mm   | 1  | SB193.004.200 |

### BahcoFit Stubby Pozidriv Screwdrivers with Rubber Grip PZ1-PZ2



#### B195PZ



| PZ1 | 25 mm | 33 mm | 10 | B195.901.025  |
|-----|-------|-------|----|---------------|
| PZ2 | 25 mm | 33 mm | 10 | B195.902.025  |
| PZ1 | 25 mm | 33 mm | 1  | SB195.901.025 |
| PZ2 | 25 mm | 33 mm | 1  | SB195.902.025 |





BahcoFit TORX® Screwdrivers with Rubber Grip T4-T45



**B194**



| T4  | 75 mm  | 24.5 mm | 10 | B194.004.075  |
|-----|--------|---------|----|---------------|
| T5  | 75 mm  | 24.5 mm | 10 | B194.005.075  |
| T6  | 75 mm  | 24.5 mm | 10 | B194.006.075  |
| T7  | 75 mm  | 24.5 mm | 10 | B194.007.075  |
| T8  | 75 mm  | 24.5 mm | 10 | B194.008.075  |
| T9  | 75 mm  | 24.5 mm | 10 | B194.009.075  |
| T10 | 75 mm  | 24.5 mm | 10 | B194.010.075  |
| T15 | 100 mm | 24.5 mm | 10 | B194.015.100  |
| T20 | 100 mm | 24.5 mm | 10 | B194.020.100  |
| T25 | 125 mm | 30 mm   | 10 | B194.025.125  |
| T27 | 125 mm | 30 mm   | 10 | B194.027.125  |
| T30 | 150 mm | 34 mm   | 10 | B194.030.150  |
| T40 | 150 mm | 34 mm   | 10 | B194.040.150  |
| T45 | 150 mm | 34 mm   | 5  | B194.045.150  |
| T4  | 75 mm  | 24.5 mm | 1  | SB194.004.075 |
| T5  | 75 mm  | 24.5 mm | 1  | SB194.005.075 |
| T6  | 75 mm  | 24.5 mm | 1  | SB194.006.075 |
| T7  | 75 mm  | 24.5 mm | 1  | SB194.007.075 |
| T8  | 75 mm  | 24.5 mm | 1  | SB194.008.075 |
| T9  | 75 mm  | 24.5 mm | 1  | SB194.009.075 |
| T10 | 75 mm  | 24.5 mm | 1  | SB194.010.075 |
| T15 | 100 mm | 24.5 mm | 1  | SB194.015.100 |
| T20 | 100 mm | 24.5 mm | 1  | SB194.020.100 |
| T25 | 125 mm | 30 mm   | 1  | SB194.025.125 |
| T27 | 125 mm | 30 mm   | 1  | SB194.027.125 |
| T30 | 150 mm | 34 mm   | 1  | SB194.030.150 |
| T40 | 150 mm | 34 mm   | 1  | SB194.040.150 |
| T45 | 150 mm | 34 mm   | 1  | SB194.045.150 |

BahcoFit Tamper-Resistant TORX® Screwdrivers with Rubber Grip TR7-TR40



**B141**



| TR7  | 75 mm  | 24.5 mm | 5 | B141.007.075  |
|------|--------|---------|---|---------------|
| TR8  | 75 mm  | 24.5 mm | 5 | B141.008.075  |
| TR9  | 75 mm  | 24.5 mm | 5 | B141.009.075  |
| TR10 | 75 mm  | 24.5 mm | 5 | B141.010.075  |
| TR15 | 100 mm | 24.5 mm | 5 | B141.015.100  |
| TR20 | 100 mm | 24.5 mm | 5 | B141.020.100  |
| TR25 | 125 mm | 30 mm   | 5 | B141.025.125  |
| TR27 | 125 mm | 30 mm   | 5 | B141.027.125  |
| TR30 | 150 mm | 34 mm   | 5 | B141.030.150  |
| TR40 | 150 mm | 34 mm   | 5 | B141.040.150  |
| TR7  | 75 mm  | 24.5 mm | 1 | SB141.007.075 |
| TR8  | 75 mm  | 24.5 mm | 1 | SB141.008.075 |
| TR9  | 75 mm  | 24.5 mm | 1 | SB141.009.075 |

**BAHCO**

| TR10 | 75 mm  | 24.5 mm | 1 | SB141.010.075 |
|------|--------|---------|---|---------------|
| TR15 | 100 mm | 24.5 mm | 1 | SB141.015.100 |
| TR20 | 100 mm | 24.5 mm | 1 | SB141.020.100 |
| TR25 | 125 mm | 30 mm   | 1 | SB141.025.125 |
| TR27 | 125 mm | 30 mm   | 1 | SB141.027.125 |
| TR30 | 150 mm | 34 mm   | 1 | SB141.030.150 |
| TR40 | 150 mm | 34 mm   | 1 | SB141.040.150 |

BahcoFit Hex Ball End Screwdrivers with Rubber Grip Hex2-8 mm



**B143**



| 2   | 100 mm | 24.5 mm | 5  | B143.020.100  |
|-----|--------|---------|----|---------------|
| 2.5 | 100 mm | 24.5 mm | 10 | B143.025.100  |
| 3   | 100 mm | 24.5 mm | 10 | B143.030.100  |
| 4   | 100 mm | 24.5 mm | 10 | B143.040.100  |
| 5   | 100 mm | 30 mm   | 10 | B143.050.100  |
| 6   | 125 mm | 34 mm   | 10 | B143.060.125  |
| 8   | 150 mm | 34 mm   | 5  | B143.080.150  |
| 2   | 100 mm | 24.5 mm | 1  | SB143.020.100 |
| 2.5 | 100 mm | 24.5 mm | 1  | SB143.025.100 |
| 3   | 100 mm | 24.5 mm | 1  | SB143.030.100 |
| 4   | 100 mm | 24.5 mm | 1  | SB143.040.100 |
| 5   | 100 mm | 30 mm   | 1  | SB143.050.100 |
| 6   | 125 mm | 34 mm   | 1  | SB143.060.125 |
| 8   | 150 mm | 34 mm   | 1  | SB143.080.150 |

BahcoFit Robertson Square Screwdrivers with Rubber Grip #1-#3



**B144**



| #1 | 100 mm | 24.5 mm | 5 | B144.001.100  |
|----|--------|---------|---|---------------|
| #2 | 125 mm | 30 mm   | 5 | B144.002.125  |
| #3 | 150 mm | 34 mm   | 5 | B144.003.150  |
| #1 | 100 mm | 24.5 mm | 1 | SB144.001.100 |
| #2 | 125 mm | 30 mm   | 1 | SB144.002.125 |
| #3 | 150 mm | 34 mm   | 1 | SB144.003.150 |

BahcoFit Awl with Rubber Grip for Pre-Punching/Drilling Holes 6 mm



**B145**

| Ø    | Length | Tip Length | Icons | Part No.      |
|------|--------|------------|-------|---------------|
| 6 mm | 100 mm | 30 mm      | 5     | B145.006.100  |
| 6 mm | 100 mm | 30 mm      | 1     | SB145.006.100 |

BahcoFit Reamers with Rubber Grip for Enlarging/Drilling Holes 6 mm



**B146**

| Ø    | Length | Tip Length | Icons | Part No.      |
|------|--------|------------|-------|---------------|
| 6 mm | 100 mm | 30 mm      | 5     | B146.006.100  |
| 6 mm | 100 mm | 30 mm      | 1     | SB146.006.100 |

BahcoFit Stubby Awl with Rubber Grip 6 mm



**B195Awl**

| Ø    | Length | Tip Length | Icons | Part No.      |
|------|--------|------------|-------|---------------|
| 4 mm | 50 mm  | 33 mm      | 5     | B195.006.050  |
| 4 mm | 50 mm  | 33 mm      | 1     | SB195.006.050 |

BahcoFit Hex Head Nut Drivers with Rubber Grip 4-14 mm



**B198**

| Ø      | Length | Tip Length | Icons | Part No.       |
|--------|--------|------------|-------|----------------|
| 4 mm   | 125 mm | 24.5 mm    | 5     | B198.040.125   |
| 4.5 mm | 125 mm | 24.5 mm    | 5     | B198.045.125   |
| 5 mm   | 150 mm | 30 mm      | 5     | B198.050.150   |
| 5.5 mm | 150 mm | 30 mm      | 5     | B198.055.150   |
| 6 mm   | 150 mm | 30 mm      | 5     | B198.060.150   |
| 6 mm   | 150 mm | 34 mm      | 5     | B198.060.150F  |
| 7 mm   | 150 mm | 34 mm      | 5     | B198.070.150   |
| 7 mm   | 150 mm | 34 mm      | 5     | B198.070.150F  |
| 8 mm   | 150 mm | 34 mm      | 5     | B198.080.150   |
| 8 mm   | 150 mm | 34 mm      | 5     | B198.080.150F  |
| 9 mm   | 150 mm | 34 mm      | 5     | B198.090.150   |
| 10 mm  | 150 mm | 34 mm      | 5     | B198.100.150   |
| 11 mm  | 150 mm | 34 mm      | 5     | B198.110.150   |
| 12 mm  | 150 mm | 34 mm      | 5     | B198.120.150   |
| 13 mm  | 150 mm | 34 mm      | 5     | B198.130.150   |
| 14 mm  | 150 mm | 34 mm      | 5     | B198.140.150   |
| 4 mm   | 125 mm | 24.5 mm    | 1     | SB198.040.125  |
| 4.5 mm | 125 mm | 24.5 mm    | 1     | SB198.045.125  |
| 5 mm   | 150 mm | 30 mm      | 1     | SB198.050.150  |
| 5.5 mm | 150 mm | 30 mm      | 1     | SB198.055.150  |
| 6 mm   | 150 mm | 30 mm      | 1     | SB198.060.150  |
| 6 mm   | 150 mm | 34 mm      | 1     | SB198.060.150F |
| 7 mm   | 150 mm | 34 mm      | 1     | SB198.070.150  |
| 7 mm   | 150 mm | 34 mm      | 1     | SB198.070.150F |
| 8 mm   | 150 mm | 34 mm      | 1     | SB198.080.150  |
| 8 mm   | 150 mm | 34 mm      | 1     | SB198.080.150F |
| 9 mm   | 150 mm | 34 mm      | 1     | SB198.090.150  |
| 10 mm  | 150 mm | 34 mm      | 1     | SB198.100.150  |
| 11 mm  | 150 mm | 34 mm      | 1     | SB198.110.150  |
| 12 mm  | 150 mm | 34 mm      | 1     | SB198.120.150  |
| 13 mm  | 150 mm | 34 mm      | 1     | SB198.130.150  |
| 14 mm  | 150 mm | 34 mm      | 1     | SB198.140.150  |



## SCREWDRIVERS WITH RUBBERED GRIP

Slotted/Phillips Screwdriver Set with Rubber Grip - 3 Pcs



**600-3**



3

1 600-3

613-3-100



611-5.5-125



615-1-100



Slotted/Phillips Screwdriver Set with Rubber Grip - 4 Pcs



**602-4-LA**



4

1 602-4-LA

613-3-100



611-5.5-100

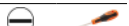

615-1-100, 615-2-125



Slotted/Phillips Screwdriver Set with Rubber Grip - 5 Pcs



**604-5**



5

1 604-5

613-3-100



611-4-100, 611-6.5-125



615-1-100, 615-2-125



TORX® Screwdriver Set with Rubber Grip - 5 Pcs



**612-5**



5

1 612-5

618-10-75, 618-15-100, 618-20-100, 618-25-125, 618-30-150



Slotted/Phillips/Pozidriv Screwdriver Set with Rubber Grip 3-4 mm/  
PH1-PH2/PZ1-PZ2 - 6 Pcs



**605-6**

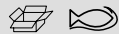

6

1 605-6

613-3-75, 613-4-100



615-1-100, 615-2-125



616-1-100, 616-2-125



Slotted/Phillips Screwdriver Set with Rubber Grip 5.5-6.5 mm/3-4 mm/  
PH1-PH2 - 6 Pcs



**606-6**



6

1 606-6

611-5.5-100, 611-6.5-125



613-3-75, 613-4-100



615-1-100, 615-2-125



Slotted/Pozidriv Screwdriver Set with Rubber Grip - 6 Pcs



**610-6**



6

1 610-6

611-5.5-100, 611-6.5-125



613-3-75, 613-4-100



616-1-100, 616-2-125



Slotted/Phillips/Robertson Screwdriver Set with Rubber Grip - 10 Pcs



**605-10-PC-AU**



10

1 605-10-PC-AU

Robertson R1x100; R2x100; Stubby PZ2 X 25

611-5.5-100, 611-6.5-125, 611-8-150



613-3-75



615-1-100, 615-2-125, 615-3-150



616-2-25, 619-1-100, 619-2-100



### Slotted Flat Screwdrivers with Rubber Grip 3.5-10 mm



#### 611

| Tip Size | Length | Shaft Diameter | Quantity | Part No.    |
|----------|--------|----------------|----------|-------------|
| 3.5 mm   | 75 mm  | 25 mm          | 10       | 611-3.5-75  |
| 3.5 mm   | 100 mm | 25 mm          | 10       | 611-3.5-100 |
| 4.0 mm   | 75 mm  | 25 mm          | 10       | 611-4-75    |
| 4.0 mm   | 100 mm | 25 mm          | 10       | 611-4-100   |
| 5.5 mm   | 100 mm | 30 mm          | 10       | 611-5.5-100 |
| 5.5 mm   | 125 mm | 30 mm          | 10       | 611-5.5-125 |
| 6.5 mm   | 25 mm  | 35 mm          | 10       | 611-6.5-25  |
| 6.5 mm   | 125 mm | 35 mm          | 10       | 611-6.5-125 |
| 6.5 mm   | 150 mm | 35 mm          | 10       | 611-6.5-150 |
| 8.0 mm   | 150 mm | 35 mm          | 10       | 611-8-150   |
| 8.0 mm   | 175 mm | 35 mm          | 10       | 611-8-175   |
| 10.0 mm  | 200 mm | 35 mm          | 10       | 611-10-200  |

### Slotted Straight Screwdrivers with Rubber Grip 3.0 -6.5 mm



#### 613

| Tip Size | Length | Shaft Diameter | Quantity | Part No.    |
|----------|--------|----------------|----------|-------------|
| 3.0 mm   | 75 mm  | 25 mm          | 10       | 613-3-75    |
| 3.0 mm   | 100 mm | 25 mm          | 10       | 613-3-100   |
| 3.5 mm   | 100 mm | 25 mm          | 10       | 613-3.5-100 |
| 4.0 mm   | 100 mm | 25 mm          | 10       | 613-4-100   |
| 4.0 mm   | 125 mm | 25 mm          | 10       | 613-4-125   |
| 5.5 mm   | 150 mm | 30 mm          | 10       | 613-5.5-150 |
| 6.5 mm   | 150 mm | 35 mm          | 10       | 613-6.5-150 |

### Phillips Screwdrivers with Rubber Grip PH0-PH3



#### 615

| Tip Size | Length | Shaft Diameter | Quantity | Part No.  |
|----------|--------|----------------|----------|-----------|
| PH 0     | 75 mm  | 25 mm          | 10       | 615-0-75  |
| PH 1     | 100 mm | 30 mm          | 10       | 615-1-100 |
| PH 2     | 25 mm  | 35 mm          | 10       | 615-2-25  |

| Tip Size | Length | Shaft Diameter | Quantity | Part No.  |
|----------|--------|----------------|----------|-----------|
| PH 2     | 125 mm | 35 mm          | 10       | 615-2-125 |
| PH 3     | 150 mm | 35 mm          | 10       | 615-3-150 |

### Pozidriv Screwdrivers with Rubber Grip PZ0-PZ3



#### 616

| Tip Size | Length | Shaft Diameter | Quantity | Part No.  |
|----------|--------|----------------|----------|-----------|
| PZ 0     | 75 mm  | 25 mm          | 10       | 616-0-75  |
| PZ 1     | 100 mm | 30 mm          | 10       | 616-1-100 |
| PZ 2     | 125 mm | 35 mm          | 10       | 616-2-125 |
| PZ 3     | 150 mm | 35 mm          | 10       | 616-3-150 |

### TORX® Screwdrivers with Rubber Grip T10-T40



#### 618

| Tip Size | Length | Shaft Diameter | Quantity | Part No.   |
|----------|--------|----------------|----------|------------|
| T 10     | 75 mm  | 25 mm          | 10       | 618-10-75  |
| T 15     | 100 mm | 25 mm          | 10       | 618-15-100 |
| T 20     | 100 mm | 25 mm          | 10       | 618-20-100 |
| T 25     | 125 mm | 30 mm          | 10       | 618-25-125 |
| T 27     | 125 mm | 30 mm          | 10       | 618-27-125 |
| T 30     | 150 mm | 35 mm          | 10       | 618-30-150 |
| T 40     | 150 mm | 35 mm          | 10       | 618-40-150 |



## SCREWDRIVERS WITH RATCHETING GRIP

### 1/4" Bit Holder Ratcheting Screwdrivers



**808050**

|      |        |         |    |        |
|------|--------|---------|----|--------|
|      |        |         |    |        |
| 1/4" | 125 mm | 41.6 mm | 50 | 808050 |

### 1/4" Heavy-Duty Bit Set for Nut Drivers & Slotted/Phillips/Pozidriv/Torx<sup>®</sup>/Hex Bits with Ratcheting Screwdriver Holder - 36 pcs



**59/S36BCR**

|    |                   |   |           |
|----|-------------------|---|-----------|
|    |                   |   |           |
| 36 | 43 x 135 x 215 mm | 6 | 59/S36BCR |

### Phillips/Pozidriv/Slotted LED Light Ratcheting Screwdriver with Ratcheting Grip



**808050L**

|        |          |         |    |             |
|--------|----------|---------|----|-------------|
|        |          |         |    |             |
| 1/4 in | 10x35 mm | 808050L | 25 | 808050L     |
|        |          |         | 1  | 808050L-SP1 |

### 1/4" Ratcheting Bit Screwdriver with Pistol Handle



**808050P**

|        |        |       |    |         |
|--------|--------|-------|----|---------|
|        |        |       |    |         |
| 1/4 in | 135 mm | 40 mm | 50 | 808050P |

### 1/4" Ratcheting Bit Screwdriver Set with Pistol Handle - 25 Pcs



**808050P-**

|                   |    |            |
|-------------------|----|------------|
|                   |    |            |
| 70 x 158 x 285 mm | 10 | 808050P-25 |

### 1/4" Bit Holder Stubby T-Handle Ratcheting Screwdrivers



**808050TS**

|        |       |       |   |          |
|--------|-------|-------|---|----------|
|        |       |       |   |          |
| 1/4 in | 68 mm | 91 mm | 1 | 808050TS |



1/4" Bit Holder Stubby Ratcheting Screwdrivers



**808050S**

|        |       |       |    |         |
|--------|-------|-------|----|---------|
|        |       |       |    |         |
| 1/4 in | 68 mm | 41 mm | 25 | 808050S |

Stubby Ratcheting Screwdriver Set - 18 Pcs



**808050S-18**

|                   |    |            |
|-------------------|----|------------|
|                   |    |            |
| 46 x 130 x 195 mm | 30 | 808050S-18 |

Stubby Ratcheting Screwdriver Set - 22-Pcs



**808050S-22**

|                   |    |            |
|-------------------|----|------------|
|                   |    |            |
| 46 x 130 x 195 mm | 30 | 808050S-22 |

**SCREWDRIVERS WITH PRECISION GRIP**

Slotted/Phillips Screwdriver Set with Precision Grip 1.5-3.0mm/PH0-PH1 - 6 Pcs



**706-1**

|   |   |       |  |  |
|---|---|-------|--|--|
|   |   |       |  |  |
| 6 | 1 | 706-1 |  |  |

700-2-50, 700-2.5-50, 700-1.5-50, 700-3-50  
701-0-50, 701-1-75

Slotted/Phillips Screwdriver Set with Precision Grip 1.0-1.8 mm/PH0-PH0 - 6 Pcs



**706-2**

|   |   |       |  |  |
|---|---|-------|--|--|
|   |   |       |  |  |
| 6 | 1 | 706-2 |  |  |

700-1.5-50, 700-1.2-50, 700-1-50, 700-1.8-50  
701-00-50, 701-0-50

Slotted Screwdriver Set with Precision Grip 1.0 - 2.5 mm - 6 Pcs



**706-3**



6



1 706-3

700-2.5-50, 700-2-50, 700-1.8-50, 700-1.5-50, 700-1.2-50, 700-1-50

Slotted/Phillips/TORX® Screwdriver Set with Precision Grip - 7 Pcs



**706-4**



7



1 706-4

700-2.5-50, 700-3.5-75, 700-1.5-50

701-1-75, 701-0-50

703-8-50, 703-6-50

Slotted/Phillips/Pozidriv/TORX/Hex Screwdriver Set with Precision Grip - 24 Pcs



**706-5**



24



1 706-5

700-3-50, 700-2-50, 700-3.5-75, 700-4-75, 700-1.5-50, 700-1.2-50, 700-1-50, 700-1.8-50

701-00-50, 701-0-50, 701-1-75

702-1-75, 702-0-50

703-6-50, 703-9-50, 703-10-50, 703-7-50, 703-8-50, 703-15-75, 703-20-75

704-2.5-50, 704-3-75, 704-1.5-50, 704-2-50

Slotted Screwdrivers with Precision Grip 1.0-4.0 mm



**700**



| Tip Size | Length | Shaft Diameter | Quantity | Part No.   |
|----------|--------|----------------|----------|------------|
| 1 mm     | 50 mm  | 14 mm          | 5        | 700-1-50   |
| 1.2 mm   | 50 mm  | 14 mm          | 5        | 700-1.2-50 |
| 1.5 mm   | 50 mm  | 14 mm          | 5        | 700-1.5-50 |
| 1.8 mm   | 50 mm  | 14 mm          | 5        | 700-1.8-50 |
| 2 mm     | 50 mm  | 14 mm          | 5        | 700-2-50   |
| 2.5 mm   | 50 mm  | 14 mm          | 5        | 700-2.5-50 |
| 3 mm     | 50 mm  | 14 mm          | 5        | 700-3-50   |
| 3 mm     | 100 mm | 14 mm          | 5        | 700-3-100  |
| 3 mm     | 200 mm | 14 mm          | 5        | 700-3-200  |
| 3.5 mm   | 75 mm  | 14 mm          | 5        | 700-3.5-75 |
| 4 mm     | 75 mm  | 14 mm          | 5        | 700-4-75   |
| 4 mm     | 250 mm | 14 mm          | 5        | 700-4-250  |



Phillips Screwdrivers with Precision Grip PH00-PH1



701



| PH 00 | 50 mm  | 14 mm | 5 | 701-00-50 |  |
|-------|--------|-------|---|-----------|--|
| PH 0  | 50 mm  | 14 mm | 5 | 701-0-50  |  |
| PH 0  | 200 mm | 14 mm | 5 | 701-0-200 |  |
| PH 1  | 75 mm  | 14 mm | 5 | 701-1-75  |  |
| PH 1  | 250 mm | 14 mm | 5 | 701-1-250 |  |

Hex Ball Screwdrivers with Precision Grip 1.5-3 mm 3/32"



704

| 1.5  | 50 mm | 14 mm | 5 | 704-1.5-50 |  |
|------|-------|-------|---|------------|--|
| 2    | 50 mm | 14 mm | 5 | 704-2-50   |  |
| 2.5  | 50 mm | 14 mm | 5 | 704-2.5-50 |  |
| 3    | 75 mm | 14 mm | 5 | 704-3-75   |  |
| 3/32 | 75 mm | 14 mm | 5 | 704Z-3/32  |  |

Pozidriv Screwdrivers with Precision Grip PZ0-PZ1



702



| PZ 0 | 50 mm | 14 mm | 5 | 702-0-50 |  |
|------|-------|-------|---|----------|--|
| PZ 1 | 75 mm | 14 mm | 5 | 702-1-75 |  |

Watchmakers Slotted Screwdrivers with Precision Grip and 4 Interchangeable Blades



510034

| 0.25x1.5, 0.3x2, 0.4x2.5, 0.5x3 | 8.5 mm | 10 | 510034 |  |
|---------------------------------|--------|----|--------|--|

0.25x1.5; 0.3x2.0; 0.4x2.5; 0.5x3.0mm

TORX® Screwdrivers with Precision Grip T4-T20



703



| T 4  | 50 mm | 14 mm | 5 | 703-4-50  |  |
|------|-------|-------|---|-----------|--|
| T 5  | 50 mm | 14 mm | 5 | 703-5-50  |  |
| T 6  | 50 mm | 14 mm | 5 | 703-6-50  |  |
| T 7  | 50 mm | 14 mm | 5 | 703-7-50  |  |
| T 8  | 50 mm | 14 mm | 5 | 703-8-50  |  |
| T 9  | 50 mm | 14 mm | 5 | 703-9-50  |  |
| T 10 | 50 mm | 14 mm | 5 | 703-10-50 |  |
| T 15 | 75 mm | 14 mm | 5 | 703-15-75 |  |
| T 20 | 75 mm | 14 mm | 5 | 703-20-75 |  |

Watchmakers Slotted Screwdrivers with Precision Grip 2.5-4.5 mm



2784

| 2.5 mm | 6 mm  | 100 mm | 1 | 2784-2.5 |
|--------|-------|--------|---|----------|
| 3.5 mm | 6 mm  | 104 mm | 1 | 2784-3.5 |
| 4.5 mm | 10 mm | 110 mm | 1 | 2784-4.5 |

Watchmakers Slotted Screwdriver Set with Precision Grip 0.6-2.5 mm - 5 Pcs



**98505**

|  |   |
|--|---|
|  |  |
| 5  | 5 98505   |

Watchmakers Slotted Screwdriver Set with Precision Grip 1.0-3.5 mm - 6 Pcs



**510031**

|  |   |
|--|---|
|  |  |
| 6  | 5 510031  |

Watchmakers Phillips Screwdriver Set with Precision Grip PH000-PH0 - 3 Pcs



**510033**

|  |   |
|--|---|
|  |  |
| 3  | 5 510033  |

PH000; PH00; PH0

## SCREWDRIVERS WITH T-HANDLE GRIP

Hex Screwdriver Set with T-Handle Grip - 6 Pcs



**903T-1**

|   |   |
|---|---|
|  |  |
| 6   | 1 903T-1  |

900T-030-100, 900T-040-150, 900T-050-150, 900T-060-200, 900T-080-200, 900T-100-200

TORX® Screwdriver Set with T-Handle Grip - 6 Pcs



**903T-2**

|   |   |
|---|---|
|  |  |
| 6   | 1 903T-2  |

901T-015-150, 901T-020-150, 901T-010-100, 901T-030-200, 901T-040-200, 901T-025-150





### Hex Nut Driver Set with T-Handle Grip - 6 Pcs



#### 903T-3



6

1 903T-3

902T-060-150, 902T-070-175, 902T-050-150, 902T-080-175, 902T-100-175, 902T-130-175

### Hex Screwdrivers with T-Handle Grip 2-10 mm



#### 900T



|        |        |       |   |              |
|--------|--------|-------|---|--------------|
| 2 mm   | 100 mm | 50 mm | 5 | 900T-020-100 |
| 2.5 mm | 100 mm | 50 mm | 5 | 900T-025-100 |
| 3 mm   | 100 mm | 50 mm | 5 | 900T-030-100 |
| 4 mm   | 138 mm | 50 mm | 5 | 900T-040-150 |
| 5 mm   | 138 mm | 60 mm | 5 | 900T-050-150 |
| 6 mm   | 185 mm | 60 mm | 5 | 900T-060-200 |
| 8 mm   | 185 mm | 60 mm | 5 | 900T-080-200 |
| 10 mm  | 185 mm | 60 mm | 5 | 900T-100-200 |

### TORX® Screwdrivers with T-Handle Grip T6-T50



#### 901T



|      |        |       |   |              |
|------|--------|-------|---|--------------|
| T 6  | 100 mm | 50 mm | 5 | 901T-006-100 |
| T 7  | 100 mm | 50 mm | 5 | 901T-007-100 |
| T 8  | 100 mm | 50 mm | 5 | 901T-008-100 |
| T 9  | 100 mm | 50 mm | 5 | 901T-009-100 |
| T 10 | 100 mm | 50 mm | 5 | 901T-010-100 |
| T 15 | 138 mm | 50 mm | 5 | 901T-015-150 |
| T 20 | 138 mm | 50 mm | 5 | 901T-020-150 |
| T 25 | 138 mm | 60 mm | 5 | 901T-025-150 |
| T 27 | 138 mm | 60 mm | 5 | 901T-027-150 |
| T 30 | 185 mm | 60 mm | 5 | 901T-030-200 |

**BAHCO**



|      |        |       |   |              |
|------|--------|-------|---|--------------|
| T 40 | 185 mm | 60 mm | 5 | 901T-040-200 |
| T 45 | 185 mm | 60 mm | 5 | 901T-045-200 |
| T 50 | 185 mm | 60 mm | 5 | 901T-050-200 |

### Hex Head Nut Drivers with T-Handle Grip 5-13 mm



#### 902T



|        |        |       |   |              |
|--------|--------|-------|---|--------------|
| 5 mm   | 136 mm | 50 mm | 5 | 902T-050-150 |
| 5.5 mm | 136 mm | 50 mm | 5 | 902T-055-150 |
| 6 mm   | 136 mm | 50 mm | 5 | 902T-060-150 |
| 7 mm   | 160 mm | 60 mm | 5 | 902T-070-175 |
| 8 mm   | 160 mm | 60 mm | 5 | 902T-080-175 |
| 9 mm   | 160 mm | 60 mm | 5 | 902T-090-175 |
| 10 mm  | 160 mm | 60 mm | 5 | 902T-100-175 |
| 11 mm  | 160 mm | 60 mm | 5 | 902T-110-175 |
| 12 mm  | 160 mm | 60 mm | 5 | 902T-120-175 |
| 13 mm  | 160 mm | 60 mm | 5 | 902T-130-175 |

### Socket Drivers with T-Handle Grip 1/4"



#### 905T



|      |       |       |   |              |
|------|-------|-------|---|--------------|
| 1/4" | 45 mm | 60 mm | 5 | 905T-060-100 |
|------|-------|-------|---|--------------|

### SCREWDRIVERS WITH 1/4" BIT HOLDERS

#### 1/4" x 125 mm Magnetic Bit Holders



#### B705



|         |        |       |   |               |
|---------|--------|-------|---|---------------|
| 1/4" in | 125 mm | 30 mm | 5 | B705.1/4.125  |
| 1/4" in | 125 mm | 30 mm | 1 | SB705.1/4.125 |

1/4" Hex Head T-Handle Bit Holders



**904T**

|        |        |   |              |
|--------|--------|---|--------------|
|        |        |   |              |
| 1/4 in | 150 mm | 5 | 904T-060-150 |



1/4" Bit Holder Screwdrivers for Phillips/Pozidriv/Slotted/TORX® Head Screw



**808050A/TORX**

|        |        |       |               |
|--------|--------|-------|---------------|
|        |        |       |               |
| 1/4 in | 115 mm | 40 mm | 1 808050A     |
| 1/4 in | 115 mm | 40 mm | 50 808050TORX |



Phillips Screwdrivers with Wooden Handle PH1-PH3



**9778**

|      |        |       |           |
|------|--------|-------|-----------|
|      |        |       |           |
| PH 1 | 80 mm  | 24 mm | 10 9778-1 |
| PH 2 | 110 mm | 27 mm | 10 9778-2 |
| PH 3 | 150 mm | 30 mm | 5 9778-3  |



Pozidriv Screwdrivers with Wooden Handle PZ1-PZ2



**9778PZD**

|      |        |       |              |
|------|--------|-------|--------------|
|      |        |       |              |
| PZ 1 | 80 mm  | 24 mm | 10 9778PZD-1 |
| PZ 2 | 110 mm | 27 mm | 10 9778PZD-2 |



Slotted/Phillips Screwdriver Set with Wooden Handle - 6 Pcs



**SCREWDRIVERS WITH WOODEN OR PLASTIC GRIP**

Slotted Flat Screwdrivers with Wooden Handle 3.5-10 mm



**9710**

|         |        |       |                 |
|---------|--------|-------|-----------------|
|         |        |       |                 |
| 3.5 mm  | 75 mm  | 22 mm | 10 9710-3.5-75  |
| 5.5 mm  | 100 mm | 24 mm | 10 9710-5.5-100 |
| 6.5 mm  | 125 mm | 27 mm | 10 9710-6.5-125 |
| 8.0 mm  | 150 mm | 30 mm | 5 9710-8-150    |
| 10.0 mm | 175 mm | 32 mm | 5 9710-10-175   |



**9710/S6**

|   |  |           |
|---|--|-----------|
|   |  |           |
| 6 |  | 1 9710/S6 |

0,8x4,5x90

9710-4.5-90

9710-5.5-100, 9710-6.5-125, 9710-8-150

9778-1, 9778-2



### Slotted and Phillips Reversible Blade Screwdrivers



#### 1019/1067



|        |      |    |      |
|--------|------|----|------|
| 4,5 mm | PH 1 | 10 | 1067 |
| 6 mm   | PH 2 | 10 | 1019 |

### Slotted/Phillips Reversible blade Screwdriver with Plastic Handle 6.0 mm/PH2



#### 8052



|      |       |       |   |      |
|------|-------|-------|---|------|
| PH 2 | 80 mm | 28 mm | 5 | 8052 |
|------|-------|-------|---|------|

### Stubby Slotted and Phillips Reversible Blade Screwdrivers



#### 1016



|      |      |    |      |
|------|------|----|------|
| 6 mm | PH 2 | 10 | 1016 |
|------|------|----|------|

### Reversible Blade Phillips/Slotted Screwdriver Set



#### 6



|                  |                |   |   |
|------------------|----------------|---|---|
| PH 0, PH 1, PH 2 | 3,5-5,0-6,5 mm | 1 | 6 |
|------------------|----------------|---|---|

### Slotted Straight Tipped Screwdrivers with Impact Grip 2.5 x 250 mm



#### 9715



|         |        |       |   |             |
|---------|--------|-------|---|-------------|
| 14.0 mm | 250 mm | 32 mm | 5 | 9715-14-250 |
|---------|--------|-------|---|-------------|

### Precision Slotted Screwdrivers with Plastic Handle 2.0-3.0 mm



#### 7372I



|        |       |       |    |              |
|--------|-------|-------|----|--------------|
| 2.0 mm | 63 mm | 13 mm | 10 | 7372I-2-63   |
| 2.5 mm | 75 mm | 13 mm | 10 | 7372I-2.5-75 |
| 3.0 mm | 80 mm | 13 mm | 10 | 7372I-3-80   |

## ELECTRICAL TESTERS

150-250 V Voltage Testers with neon indicator



**806**



|        |        |         |   |         |
|--------|--------|---------|---|---------|
|        |        |         |   |         |
| 3.0 mm | 65 mm  | 16 mm   | 6 | 806-1-1 |
| 3.5 mm | 100 mm | 17.5 mm | 6 | 806-1-2 |

6-24V Auto Tester with neon light

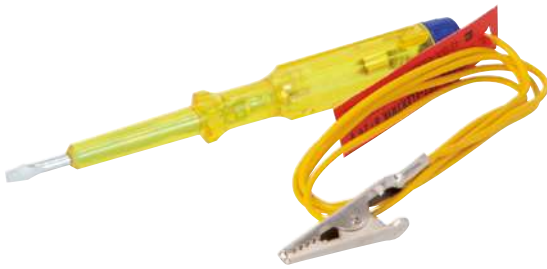

**806-1-3**



|      |       |       |   |         |
|------|-------|-------|---|---------|
|      |       |       |   |         |
| 3 mm | 45 mm | 16 mm | 6 | 806-1-3 |

150-250 V Voltage Tester, 3.5 mm, 77 mm blade with neon indicator



**8045VDE**



|        |       |       |    |         |
|--------|-------|-------|----|---------|
|        |       |       |    |         |
| 3.5 mm | 77 mm | 14 mm | 10 | 8045VDE |

150-250 V Voltage Tester, 3.5 mm, 42 mm blade with neon indicator



**8045LVDE**



|        |       |       |    |          |
|--------|-------|-------|----|----------|
|        |       |       |    |          |
| 3.5 mm | 42 mm | 16 mm | 10 | 8045LVDE |

## ACCESSORIES

Magnetising and Demagnetising Boxes for Screwdriver Blades/Tweezers



**M780**

|                 |   |      |
|-----------------|---|------|
|                 |   |      |
| 29 x 52 x 50 mm | 1 | M780 |

Magnetizer and Demagnetizer for Screwdriver Blades/Tweezers/Scissors



**M781**

|                  |   |      |
|------------------|---|------|
|                  |   |      |
| 22 x 125 x 40 mm | 5 | M781 |





**BAHCO**





## L-Keys



## HEXAGONAL TIPPED

Metric Hex L-Keys with Nickel Finish



**1998M**

| Hex Size | Length | Qty | Part No.  |
|----------|--------|-----|-----------|
| 1.5 mm   | 47 mm  | 10  | 1998M-1.5 |
| 2 mm     | 52 mm  | 10  | 1998M-2   |
| 2.5 mm   | 59 mm  | 10  | 1998M-2.5 |
| 3.0 mm   | 66 mm  | 10  | 1998M-3   |
| 4.0 mm   | 74 mm  | 10  | 1998M-4   |
| 5.0 mm   | 85 mm  | 10  | 1998M-5   |
| 6.0 mm   | 96 mm  | 10  | 1998M-6   |
| 7.0 mm   | 102 mm | 10  | 1998M-7   |
| 8.0 mm   | 108 mm | 10  | 1998M-8   |
| 9.0 mm   | 114 mm | 5   | 1998M-9   |
| 10 mm    | 122 mm | 10  | 1998M-10  |
| 12.0 mm  | 137 mm | 5   | 1998M-12  |
| 14.0 mm  | 154 mm | 1   | 1998M-14  |
| 17.0 mm  | 177 mm | 1   | 1998M-17  |
| 19.0 mm  | 199 mm | 1   | 1998M-19  |
| 22.0 mm  | 222 mm | 1   | 1998M-22  |

Metric Hex L-Key Set with Nickel Finish - 6 Pcs



**1998M/6T**

| Hex Size              | Qty | Part No. |
|-----------------------|-----|----------|
| 2, 2.5, 3, 4, 5, 6 mm | 6   | 1998M/6T |

**1998M-4, 1998M-5, 1998M-6, 1998M-2.5, 1998M-2, 1998M-3**

Metric Hex L-Key Set with Nickel Finish - 8 Pcs



**1998M/8T**

| Hex Size                    | Qty | Part No. |
|-----------------------------|-----|----------|
| 2, 2.5, 3, 4, 5, 6, 7, 8 mm | 8   | 1998M/8T |

**1998M-3, 1998M-2, 1998M-6, 1998M-7, 1998M-4, 1998M-5, 1998M-8, 1998M-2.5**

Metric Hex L-Key Set with Nickel Finish - 10 Pcs



**1998M/10T**

| Hex Size                           | Qty | Part No.  |
|------------------------------------|-----|-----------|
| 2, 2.5, 3, 4, 5, 6, 7, 8, 9, 10 mm | 10  | 1998M/10T |

**1998M-5, 1998M-4, 1998M-7, 1998M-6, 1998M-2, 1998M-3, 1998M-2.5, 1998M-8, 1998M-9, 1998M-10**

Metric Hex L-Key Set with Nickel Finish - 11 Pcs



**1998M/11T**

| Hex Size                               | Qty | Part No.  |
|--|-----|-----------|
| 2, 2.5, 3, 4, 5, 6, 7, 8, 9, 10, 12 mm | 11  | 1998M/11T |

**1998M-5, 1998M-4, 1998M-7, 1998M-6, 1998M-2, 1998M-3, 1998M-2.5, 1998M-8, 1998M-9, 1998M-10, 1998M-12**

Metric Hex L-Key Set with Nickel Finish - 15 Pcs



**1998M/15T**

| Hex Size   | Qty | Part No.  |
|--|-----|-----------|
| 2, 2.5, 3, 4, 5, 6, 7, 8, 9, 10, 12, 14, 17, 19, 22 mm | 15  | 1998M/15T |

**1998M-2, 1998M-5, 1998M-4, 1998M-7, 1998M-6, 1998M-3, 1998M-2.5, 1998M-14, 1998M-17, 1998M-19, 1998M-22, 1998M-8, 1998M-9, 1998M-10, 1998M-12**

Metric Hex L-Key Set with Nickel Finish and Two-Component Compact Holder - 9 Pcs



**BE-9878**

| Hex Size                          | Qty | Part No. |
|-----------------------------------|-----|----------|
| 1.5, 2, 2.5, 3, 4, 5, 6, 8, 10 mm | 9   | BE-9878  |

**1998M-1.5, 1998M-2.5, 1998M-2, 1998M-3, 1998M-4, 1998M-5, 1998M-6, 1998M-8, 1998M-10**

Metric Hex L-Key Ring Set with Nickel Finish - 8 Pcs



**1998M/8R**

| Hex Size                    | Qty | Part No. |
|-----------------------------|-----|----------|
| 2, 2.5, 3, 4, 5, 6, 7, 8 mm | 8   | 1998M/8R |

Metric Hex Folding L-Key Set with Zinc Finish - 7 Pcs



**1999M/7H**

| Hex Size                  | Qty | Part No. |
|---------------------------|-----|----------|
| 2.5, 3, 4, 5, 6, 8, 10 mm | 7   | 1999M/7H |

Imperial Long Ball End Hex L-Key Set with Nickel Finish - 12 Pcs



**BE-9880**

|  |    |   |         |
|--|----|---|---------|
|  |    |   |         |
| 0.050; 1/16; 5/64; 3/32;<br>7/64; 1/8; 9/64; 5/32;<br>3/16; 7/32; 1/4; 5/16 in | 12 | 3 | BE-9880 |

| 1/8 in  | 66 mm  | 10 | 1995Z-1/8  |
|---------|--------|----|------------|
| 5/32 in | 74 mm  | 10 | 1995Z-5/32 |
| 3/16 in | 85 mm  | 10 | 1995Z-3/16 |
| 7/32 in | 91 mm  | 10 | 1995Z-7/32 |
| 1/4 in  | 96 mm  | 10 | 1995Z-1/4  |
| 5/16 in | 108 mm | 10 | 1995Z-5/16 |
| 3/8 in  | 122 mm | 10 | 1995Z-3/8  |
| 7/16 in | 129 mm | 10 | 1995Z-7/16 |
| 1/2 in  | 145 mm | 10 | 1995Z-1/2  |
| 5/8 in  | 168 mm | 10 | 1995Z-5/8  |
| 3/4 in  | 199 mm | 10 | 1995Z-3/4  |

Metric Hex L-Key Set with Phosphate Finish - 10 Pcs



**1995M/10T**

|                                       |    |   |           |
|---------------------------------------|----|---|-----------|
|                                       |    |   |           |
| 2, 2.5, 3, 4, 5, 6,<br>7, 8, 9, 10 mm | 10 | 1 | 1995M/10T |

Metric Hex L-Key Set with Phosphate Finish - 6 Pcs



**1995M/6T**

|                          |   |   |          |
|--------------------------|---|---|----------|
|                          |   |   |          |
| 2, 2.5, 3, 4,<br>5, 6 mm | 6 | 1 | 1995M/6T |

1995M-2, 5, 1995M-2, 1995M-6, 1995M-5, 1995M-4, 1995M-3, 1995M-9, 1995M-10, 1995M-7, 1995M-8

Metric Hex L-Keys with Phosphate Finish



**1995M**

| 0.9 mm | 33 mm  | 10 | 1995M-0.9 |
|--------|--------|----|-----------|
| 1.5 mm | 47 mm  | 10 | 1995M-1.5 |
| 2.0 mm | 52 mm  | 10 | 1995M-2   |
| 2.5 mm | 59 mm  | 10 | 1995M-2.5 |
| 3.0 mm | 66 mm  | 10 | 1995M-3   |
| 4.0 mm | 74 mm  | 10 | 1995M-4   |
| 5.0 mm | 85 mm  | 10 | 1995M-5   |
| 6.0 mm | 96 mm  | 10 | 1995M-6   |
| 7.0 mm | 102 mm | 10 | 1995M-7   |
| 8.0 mm | 108 mm | 10 | 1995M-8   |
| 9.0 mm | 114 mm | 10 | 1995M-9   |
| 10 mm  | 122 mm | 10 | 1995M-10  |
| 12 mm  | 137 mm | 10 | 1995M-12  |
| 14 mm  | 154 mm | 10 | 1995M-14  |
| 17 mm  | 177 mm | 10 | 1995M-17  |
| 19 mm  | 199 mm | 10 | 1995M-19  |
| 22 mm  | 222 mm | 10 | 1995M-22  |

Metric Hex L-Key Set with Phosphate Finish - 11 Pcs



**1995M/11T**

|   |    |   |           |
|---|----|---|-----------|
|   |    |   |           |
| 2, 2.5, 3, 4, 5, 6,<br>7, 8, 9, 10, 12 mm | 11 | 1 | 1995M/11T |

1995M-2, 1995M-2.5, 1995M-6, 1995M-5, 1995M-4, 1995M-3

Metric Hex L-Key Set with Phosphate Finish - 8 Pcs



**1995M/8T**

|                                |   |   |          |
|--------------------------------|---|---|----------|
|                                |   |   |          |
| 2, 2.5, 3, 4, 5,<br>6, 7, 8 mm | 8 | 1 | 1995M/8T |

1995M-2, 1995M-6, 1995M-5, 1995M-4, 1995M-2.5, 1995M-3, 1995M-9, 1995M-10, 1995M-7, 1995M-8, 1995M-12

Imperial Hex L-Keys with Phosphate Finish



**1995Z**

| 1/16 in | 47 mm | 10 | 1995Z-1/16 |
|---------|-------|----|------------|
| 5/64 in | 52 mm | 10 | 1995Z-5/64 |
| 3/32 in | 59 mm | 10 | 1995Z-3/32 |

Metric Hex L-Key Set with Phosphate Finish - 15 Pcs



**1995M/15T**

|  |    |   |           |
|--|----|---|-----------|
|  |    |   |           |
| 2, 2.5, 3, 4, 5, 6,<br>7, 8, 9, 10, 12, 14,<br>17, 19, 22 mm | 15 | 1 | 1995M/15T |

1995M-2.5, 1995M-2, 1995M-6, 1995M-5, 1995M-4, 1995M-3, 1995M-7, 1995M-8

1995M-2.5, 1995M-2, 1995M-6, 1995M-5, 1995M-4, 1995M-3, 1995M-9, 1995M-10, 1995M-7, 1995M-8, 1995M-17, 1995M-19, 1995M-12, 1995M-14, 1995M-22



Metric Hex L-Key Set with Phosphate Finish and Two-Component Holder - 9 Pcs



**BE-9578**

|                                   |   |   |         |
|-----------------------------------|---|---|---------|
|                                   |   |   |         |
| 1.5, 2, 2.5, 3, 4, 5, 6, 8, 10 mm | 9 | 1 | BE-9578 |

1995M-2,5, 1995M-2, 1995M-1.5, 1995M-6, 1995M-5, 1995M-4, 1995M-3, 1995M-8, 1995M-10

Metric Hex Folding L-Key Set with Two-Component Handle 2.5 mm -10 mm - 7 Pcs



**BE-9777B**

|                     |   |   |          |
|---------------------|---|---|----------|
|                     |   |   |          |
| 2.5 3 4 5 6 8 10 mm | 7 | 6 | BE-9777B |

2.5, 3, 4, 5, 6, 8, 10 mm

Metric Hex Folding L-Key Set 1.5 mm-6 mm - 7 Pcs



**BE-9776**

|                      |   |         |
|----------------------|---|---------|
|                      |   |         |
| 1.5 2 2.5 3 4 5 6 mm | 6 | BE-9776 |

1.5, 2, 2.5, 3, 4, 5, 6 mm

Metric Hex Folding L-Key Set 2.5 mm-10 mm - 7 Pcs



**BE-9777**

|                     |   |   |         |
|---------------------|---|---|---------|
|                     |   |   |         |
| 2.5 3 4 5 6 8 10 mm | 7 | 6 | BE-9777 |

2.5, 3, 4, 5, 6, 8, 10 mm

Imperial Hex L-Key Set with Phosphate Finish - 10 Pcs



**1995Z/**

|  |    |   |           |
|--|----|---|-----------|
|  |    |   |           |
| 1/16, 5/64, 3/32, 1/8, 5/32, 3/16, 7/32, 1/4, 5/16, 3/8 in | 10 | 1 | 1995Z/10T |

1995Z-1/16, 1995Z-5/64, 1995Z-3/32, 1995Z-1/8, 1995Z-5/32, 1995Z-3/16, 1995Z-3/8, 1995Z-7/32, 1995Z-1/4, 1995Z-5/16

Imperial Hex L-Key Set with Phosphate Finish - 12 Pcs



**1995Z/12T**

|   |    |   |           |
|---|----|---|-----------|
|   |    |   |           |
| 1/16, 5/64, 3/32, 1/8, 5/32, 3/16, 7/32, 1/4, 5/16, 3/8, 7/16, 1/2 in | 12 | 1 | 1995Z/12T |

1995Z-1/16, 1995Z-5/64, 1995Z-3/32, 1995Z-1/8, 1995Z-5/32, 1995Z-3/16, 1995Z-1/2, 1995Z-7/16, 1995Z-3/8, 1995Z-7/32, 1995Z-1/4, 1995Z-5/16

Imperial Hex Folding L-Key Set 3/32" - 3/8" - 7 Pcs



**BE-9787**

|                                    |   |   |         |
|------------------------------------|---|---|---------|
|                                    |   |   |         |
| 3/32 1/8 5/32 3/16 1/4 5/16 3/8 in | 7 | 6 | BE-9787 |

Metric Long Hex L-Keys with Phosphate Finish



**1995LM**

|        |        |    |            |
|--------|--------|----|------------|
|        |        |    |            |
| 1.5 mm | 91 mm  | 10 | 1995LM-1.5 |
| 2 mm   | 102 mm | 10 | 1995LM-2   |
| 2.5 mm | 114 mm | 10 | 1995LM-2,5 |
| 3.0 mm | 129 mm | 10 | 1995LM-3   |
| 4.0 mm | 144 mm | 10 | 1995LM-4   |
| 5.0 mm | 165 mm | 10 | 1995LM-5   |
| 6.0 mm | 186 mm | 10 | 1995LM-6   |
| 7.0 mm | 197 mm | 10 | 1995LM-7   |
| 8.0 mm | 208 mm | 10 | 1995LM-8   |
| 9.0 mm | 219 mm | 10 | 1995LM-9   |
| 10 mm  | 234 mm | 10 | 1995LM-10  |
| 12 mm  | 262 mm | 10 | 1995LM-12  |
| 14 mm  | 294 mm | 10 | 1995LM-14  |

Metric Long Hex L-Key Set with Phosphate Finish and Two-Component Holder - 6 Pcs



**BE-9586**

|                         |   |   |         |
|-------------------------|---|---|---------|
|                         |   |   |         |
| 1.5, 2, 2.5, 3, 4, 5 mm | 6 | 1 | BE-9586 |

1995LM-1.5, 1995LM-3, 1995LM-2,5, 1995LM-2, 1995LM-4, 1995LM-5



Metric Long Hex L-Key Set with Phosphate Finish and Two-Component Holder - 9 Pcs



**BE-9588**

|                                   |   |   |         |
|-----------------------------------|---|---|---------|
|                                   |   |   |         |
| 1.5, 2, 2.5, 3, 4, 5, 6, 8, 10 mm | 9 | 1 | BE-9588 |

1995LM-1.5, 1995LM-2, 1995LM-2.5, 1995LM-3, 1995LM-4, 1995LM-5, 1995LM-6, 1995LM-8, 1995LM-10

Metric Long Ball End Hex L-Keys with Phosphate Finish



**1996M**

|        |        |    |           |
|--------|--------|----|-----------|
|        |        |    |           |
| 1.5 mm | 91 mm  | 10 | 1996M-1.5 |
| 2.0 mm | 102 mm | 10 | 1996M-2   |
| 2.5 mm | 114 mm | 10 | 1996M-2.5 |
| 3.0 mm | 129 mm | 10 | 1996M-3   |
| 4.0 mm | 144 mm | 10 | 1996M-4   |
| 5.0 mm | 165 mm | 10 | 1996M-5   |
| 6.0 mm | 186 mm | 10 | 1996M-6   |
| 8.0 mm | 208 mm | 10 | 1996M-8   |
| 10 mm  | 234 mm | 10 | 1996M-10  |
| 12 mm  | 262 mm | 5  | 1996M-12  |

Metric Long Ball End Coloured Hex L-Key Set - 9 Pcs



**C1997LM/9P**

|                                   |   |   |            |
|-----------------------------------|---|---|------------|
|                                   |   |   |            |
| 1.5, 2, 2.5, 3, 4, 5, 6, 8, 10 mm | 9 | 1 | C1997LM/9P |

Metric Long Ball End Hex L-Key Set with Phosphate Finish - 6 Pcs



**BE-9765**

|                         |   |   |         |
|-------------------------|---|---|---------|
|                         |   |   |         |
| 1.5, 2, 2.5, 3, 4, 5 mm | 6 | 3 | BE-9765 |

1996M-1.5, 1996M-2.5, 1996M-2, 1996M-4, 1996M-3, 1996M-5

Metric Long Ball End Hex L-Key Set with Phosphate Finish - 9 Pcs



**BE-9770**

|                                   |   |   |         |
|-----------------------------------|---|---|---------|
|                                   |   |   |         |
| 1.5, 2, 2.5, 3, 4, 5, 6, 8, 10 mm | 9 | 3 | BE-9770 |

1996M-1.5, 1996M-2.5, 1996M-2, 1996M-4, 1996M-3, 1996M-5, 1996M-6, 1996M-10, 1996M-8

Metric Long Ball End Hex L-Key Set with Phosphate Finish and Two-Component Holder - 9 Pcs



**BE-9676**

|                         |   |   |         |
|-------------------------|---|---|---------|
|                         |   |   |         |
| 1.5, 2, 2.5, 3, 4, 5 mm | 6 | 1 | BE-9676 |

1996M-5, 1996M-4, 1996M-3, 1996M-2.5, 1996M-2, 1996M-1.5

Metric Long Ball End Hex L-Key Set with Phosphate Finish and Two-Component Holder - 9 Pcs



**BE-9678**

|                                   |   |   |         |
|-----------------------------------|---|---|---------|
|                                   |   |   |         |
| 1.5, 2, 2.5, 3, 4, 5, 6, 8, 10 mm | 9 | 1 | BE-9678 |

1996M-4, 1996M-5, 1996M-2.5, 1996M-3, 1996M-10, 1996M-6, 1996M-8, 1996M-2, 1996M-1.5

Metric Long Ball End Hex L-Key Set with Phosphate Finish and Two-Component Magnetiser Holder - 9 Pcs



**BE-9688**

|                                   |   |   |         |
|-----------------------------------|---|---|---------|
|                                   |   |   |         |
| 1.5, 2, 2.5, 3, 4, 5, 6, 8, 10 mm | 9 | 1 | BE-9688 |

1996M-1.5, 1996M-2, 1996M-2.5, 1996M-3, 1996M-4, 1996M-5, 1996M-6, 1996M-8, 1996M-10

Metric Ball End Hex Folding L-Key Set with Two-Component Handle 2.5 mm - 10 mm - 7 Pcs



**BE-9776B**

|                           |   |   |          |
|---------------------------|---|---|----------|
|                           |   |   |          |
| 2.5, 3, 4, 5, 6, 8, 10 mm | 7 | 6 | BE-9776B |





Imperial Long Ball End Hex L-Key Set with Phosphate Finish - 7 Pcs



**BE-9775**

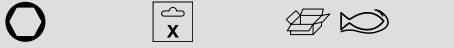

1/16, 5/64, 3/32, 1/8, 5/32, 3/16, 1/4 in 7 3 BE-9775

5/64 3/32 1/4 1/8 1/16 5/32 3/16

Imperial Long Ball End Hex L-Key Set with Phosphate Finish - 12 Pcs



**BE-9780**

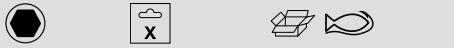

0.05 1/16 5/64 3/32 7/64 1/8 9/64 5/32 3/16 7/32 1/4 5/16 in 12 3 BE-9780

0.05 1/16 5/64 3/32 7/64 1/8 9/64 5/32 3/16 7/32 1/4 5/16

Imperial Long Ball End Hex L-Key Set with Phosphate Finish - 13 Pcs



**BE-9785**

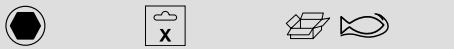

0.05 1/16 5/64 3/32 7/64 1/8 9/64 5/32 3/16 7/32 1/4 5/16 3/8 in 13 3 BE-9785

0.05 1/16 5/64 3/32 7/64 1/8 9/64 5/32 3/16 7/32 1/4 5/16 3/8

**TORX® TIPPED**

Long TORX® L-Keys with Black Oxide Finish



**1995TORX**

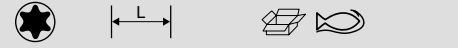

|      |        |   |              |
|------|--------|---|--------------|
| T 6  | 75 mm  | 5 | 1995TORX-T6  |
| T 7  | 80 mm  | 5 | 1995TORX-T7  |
| T 8  | 80 mm  | 5 | 1995TORX-T8  |
| T 9  | 80 mm  | 5 | 1995TORX-T9  |
| T 10 | 86 mm  | 5 | 1995TORX-T10 |
| T 15 | 90 mm  | 5 | 1995TORX-T15 |
| T 20 | 95 mm  | 5 | 1995TORX-T20 |
| T 25 | 100 mm | 5 | 1995TORX-T25 |
| T 27 | 105 mm | 5 | 1995TORX-T27 |
| T 30 | 114 mm | 5 | 1995TORX-T30 |
| T 40 | 124 mm | 5 | 1995TORX-T40 |
| T 45 | 133 mm | 5 | 1995TORX-T45 |
| T 50 | 152 mm | 5 | 1995TORX-T50 |
| T 55 | 184 mm | 5 | 1995TORX-T55 |
| T 60 | 204 mm | 5 | 1995TORX-T60 |

Long TORX® Coloured L-Key Set - 9 Pcs



**C1997TORX/9P**

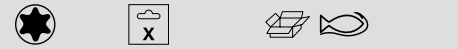

8, 9, 10, 15, 20, 25, 27, 30, 40 9 1 C1997TORX/9P

Long TORX® L-Key Set with Black Oxide Finish - 4 Pcs



**1995TORX/**



10, 20, 30, 40 4 1 1995TORX/4T

1995TORX-T40, 1995TORX-T30, 1995TORX-T10, 1995TORX-T20



Long TORX® L-Key Set with Black Oxide Finish - 7 Pcs



**1995TORX/7T**

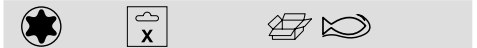

10, 15, 20, 25, 27, 30, 40 7 1 1995TORX/7T

1995TORX-T20, 1995TORX-T10, 1995TORX-T15, 1995TORX-T27, 1995TORX-T25, 1995TORX-T30, 1995TORX-T40

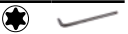

Long TORX® L-Key Set with Black Oxide Finish - 11 Pcs



**1995TORX/11T**



7, 9, 10, 15, 20, 25, 27, 30, 40, 45, 50 11 1 1995TORX/11T

1995TORX-T7, 1995TORX-T9, 1995TORX-T10, 1995TORX-T15, 1995TORX-T20, 1995TORX-T25, 1995TORX-T27, 1995TORX-T30, 1995TORX-T40, 1995TORX-T45, 1995TORX-T50



Long TORX® L-Key Set with Black Oxide Finish - 13 Pcs



**1995TORX/13T**

|  |    |   |              |
|--|----|---|--------------|
|  |    |   |              |
| 6, 7, 8, 9, 10, 15, 20, 25, 27, 30, 40, 45, 50 | 13 | 1 | 1995TORX/13T |

1995TORX-T45, 1995TORX-T40, 1995TORX-T30, 1995TORX-T27, 1995TORX-T25, 1995TORX-T20, 1995TORX-T15, 1995TORX-T10, 1995TORX-T50, 1995TORX-T8, 1995TORX-T9, 1995TORX-T6, 1995TORX-T7

Long TORX® L-Key Set with Black Oxide Finish - 8 Pcs



**BE-9575**

|                                       |   |   |         |
|---------------------------------------|---|---|---------|
|                                       |   |   |         |
| T9, T10, T15, T20, T25, T27, T30, T40 | 8 | 1 | BE-9575 |

1995TORX-T40, 1995TORX-T30, 1995TORX-T27, 1995TORX-T25, 1995TORX-T20, 1995TORX-T15, 1995TORX-T10, 1995TORX-T9

Long TORX® L-Key Set with Black Oxide Finish - 8 Pcs



**BE-9585**

|                                       |   |   |         |
|---------------------------------------|---|---|---------|
|                                       |   |   |         |
| T9, T10, T15, T20, T25, T27, T30, T40 | 8 | 1 | BE-9585 |

1995TORX-T30, 1995TORX-T27, 1995TORX-T25, 1995TORX-T20, 1995TORX-T15, 1995TORX-T10, 1995TORX-T9, 1995TORX-T40

Folding TORX® L-Key Set with Two Component Handle T9 - T40 - 8 Pcs



**BE-8975B**

|  |   |   |          |
|--|---|---|----------|
|  |   |   |          |
| T 9 - T 10 - T 15 - T 20 - T 25 - T 27 - T 30 - T 40 | 8 | 6 | BE-8975B |

Folding TORX® L-Key Set T9 - T40 - 8 Pcs



**BE-8975**

|                          |   |   |         |
|--------------------------|---|---|---------|
|                          |   |   |         |
| T 9 10 15 20 25 27 30 40 | 8 | 6 | BE-8975 |

Long Ball End TORX® L-Keys with Black Oxide Finish



**1996TORX**

|                             |                                  |                  |   |
|-----------------------------|----------------------------------|------------------|---|
|                             |                                  |                  |   |
| T 9<br>T 10<br>T 15<br>T 20 | 80 mm<br>86 mm<br>90 mm<br>95 mm | 5<br>5<br>5<br>5 | 1996TORX-T9<br>1996TORX-T10<br>1996TORX-T15<br>1996TORX-T20 |

|  |  |                            |  |
|--|--|----------------------------|--|
|  |  |                            |  |
| T 25<br>T 27<br>T 30<br>T 40<br>T 45<br>T 50 | 100 mm<br>105 mm<br>114 mm<br>124 mm<br>133 mm<br>152 mm | 5<br>5<br>5<br>5<br>5<br>5 | 1996TORX-T25<br>1996TORX-T27<br>1996TORX-T30<br>1996TORX-T40<br>1996TORX-T45<br>1996TORX-T50 |

Long Ball End TORX® L-Key Set with Black Oxide Finish - 5 Pcs



**1996TORX/**

|                         |   |   |             |
|-------------------------|---|---|-------------|
|                         |   |   |             |
| T10, T20, T25, T30, T40 | 5 | 1 | 1996TORX/5T |

1996TORX-T10, 1996TORX-T20, 1996TORX-T25, 1996TORX-T30, 1996TORX-T40

Long Ball End TORX® L-Key Set with Black Oxide Finish - 8 Pcs



**BE-9675**

|                                       |   |   |         |
|---------------------------------------|---|---|---------|
|                                       |   |   |         |
| T9, T10, T15, T20, T25, T27, T30, T40 | 8 | 1 | BE-9675 |

1996TORX-T10, 1996TORX-T9, 1996TORX-T15, 1996TORX-T20, 1996TORX-T25, 1996TORX-T27, 1996TORX-T30, 1996TORX-T40



Long Tamper-Resistant TORX® L-Keys with Black Oxide Finish



**1986TORX**

| Key Size | Length (mm) | Quantity | Part Number  |
|----------|-------------|----------|--------------|
| TR 9     | 80 mm       | 5        | 1986TORX-T9  |
| TR 10    | 86 mm       | 5        | 1986TORX-T10 |
| TR 15    | 90 mm       | 5        | 1986TORX-T15 |
| TR 20    | 95 mm       | 5        | 1986TORX-T20 |
| TR 25    | 100 mm      | 5        | 1986TORX-T25 |
| TR 27    | 105 mm      | 5        | 1986TORX-T27 |
| TR 30    | 114 mm      | 5        | 1986TORX-T30 |
| TR 40    | 124 mm      | 5        | 1986TORX-T40 |

1986TORX-T10, 1986TORX-T9, 1986TORX-T20, 1986TORX-T15, 1986TORX-T30, 1986TORX-T40, 1986TORX-T25, 1986TORX-T27

Folding TORX® Tamper L-Key Set with Two Component Handle T9 - T40 - 8 Pcs



**BE-8976B**

| Key Size                              | Quantity | Part Number |
|---------------------------------------|----------|-------------|
| T9, T10, T15, T20, T25, T27, T30, T40 | 8        | 6 BE-8976B  |

Long TORX® Plus L-Keys with Black Oxide Finish



**1976TORX**

| Key Size | Length (mm) | Quantity | Part Number  |
|----------|-------------|----------|--------------|
| IP 6     | 75 mm       | 5        | 1976TORX-T6  |
| IP 7     | 80 mm       | 5        | 1976TORX-T7  |
| IP 8     | 80 mm       | 5        | 1976TORX-T8  |
| IP 9     | 80 mm       | 5        | 1976TORX-T9  |
| IP 10    | 86 mm       | 5        | 1976TORX-T10 |
| IP 15    | 90 mm       | 5        | 1976TORX-T15 |
| IP 20    | 95 mm       | 5        | 1976TORX-T20 |
| IP 25    | 100 mm      | 5        | 1976TORX-T25 |
| IP 27    | 105 mm      | 5        | 1976TORX-T27 |
| IP 30    | 114 mm      | 5        | 1976TORX-T30 |
| IP 40    | 124 mm      | 5        | 1976TORX-T40 |

Long Tamper-Resistant TORX® L-Key Set with Black Oxide Finish - 7 Pcs



**1986TORX/**

| Key Size                                 | Quantity | Part Number   |
|--|----------|---------------|
| TR10, TR15, TR20, TR25, TR27, TR30, TR40 | 7        | 1 1986TORX/7T |

1986TORX-T10, 1986TORX-T15, 1986TORX-T20, 1986TORX-T25, 1986TORX-T27, 1986TORX-T30, 1986TORX-T40

Long Tamper-Resistant TORX® L-Key Set with Black Oxide Finish - 8 Pcs



**BE-8675**

| Key Size                              | Quantity | Part Number |
|---------------------------------------|----------|-------------|
| T9, T10, T15, T20, T25, T27, T30, T40 | 8        | 1 BE-8675   |

Long TORX® Plus L-Key Set with Black Oxide Finish - 5 Pcs



**1976TORX/**

| Key Size                          | Quantity | Part Number   |
|-----------------------------------|----------|---------------|
| IP 10, IP 20, IP 25, IP 30, IP 40 | 5        | 1 1976TORX/5T |

1976TORX-T10, 1976TORX-T20, 1976TORX-T25, 1976TORX-T40, 1976TORX-T30

Long TORX® Plus L-Key Set with Black Oxide Finish - 8 Pcs



**BE-7675**

| Key Size                                      | Quantity | Part Number |
|---|----------|-------------|
| IP9, IP10, IP15, IP20, IP25, IP27, IP30, IP40 | 8        | 1 BE-7675   |

1976TORX-T10, 1976TORX-T9, 1976TORX-T15, 1976TORX-T20, 1976TORX-T25, 1976TORX-T30, 1976TORX-T40, 1976TORX-T27

## DOUBLE OFFSET

### Double Offset Slotted L-Keys



#### 2047

| Width   | Length | Quantity | Part Number |
|---------|--------|----------|-------------|
| 4.0 mm  | 100 mm | 5        | 2047-0.8-4  |
| 5.5 mm  | 125 mm | 5        | 2047-1-5.5  |
| 8.0 mm  | 150 mm | 5        | 2047-1.2-8  |
| 10.0 mm | 175 mm | 1        | 2047-1.6-10 |
| 12.0 mm | 200 mm | 1        | 2047-2-12   |

### Double Offset Pozidriv L-Keys



#### 2047PZ

| Size     | Length | Quantity | Part Number |
|----------|--------|----------|-------------|
| PZ1, PZ2 | 100 mm | 5        | 2047PZ-1-2  |

## MULTITOOLS

### Mixed Bicycle Folding Tool Set with Pouch



### Double Offset Phillips L-Keys



#### 2047PR

| Size     | Length | Quantity | Part Number |
|----------|--------|----------|-------------|
| PH 1 & 2 | 100 mm | 5        | 2047PR-1-2  |
| PH 3 & 4 | 200 mm | 5        | 2047PR-3-4  |

#### BKE850901N

|                   |    |            |
|-------------------|----|------------|
| 200 x 35 x 170 mm | 10 | BKE850901N |
|-------------------|----|------------|







**BAHCO**





# Pliers



## CUTTING PLIERS

ERGO™ Side Cutting Pliers with Self Opening Dual-Component Handle and Phosphate Finish



ergo



### 2101G

| Cu     | Fe+    | Plato  |   |             |
|--------|--------|--------|---|-------------|
| 3.5 mm | 1.8 mm | 1.6 mm | 5 | 2101G-125   |
| 3.7 mm | 2.0 mm | 1.8 mm | 5 | 2101G-140   |
| 3.8 mm | 2.5 mm | 2.0 mm | 5 | 2101G-160   |
| 4.0 mm | 2.7 mm | 2.3 mm | 5 | 2101G-180   |
| 3.5 mm | 1.8 mm | 1.6 mm | 5 | 2101G-125IP |
| 3.7 mm | 2.0 mm | 1.8 mm | 5 | 2101G-140IP |
| 3.8 mm | 2.5 mm | 2.0 mm | 5 | 2101G-160IP |
| 4.0 mm | 2.7 mm | 2.3 mm | 5 | 2101G-180IP |

ERGO™ Side Cutting Pliers with Dual-Component Handle and Phosphate Finish



ergo



### 2101G\_D

| Cu     | Fe+    | Plato  |   |              |
|--------|--------|--------|---|--------------|
| 3.5 mm | 1.8 mm | 1.6 mm | 5 | 2101G-125IPD |
| 3.7 mm | 2.0 mm | 1.8 mm | 5 | 2101G-140IPD |
| 3.8 mm | 2.5 mm | 2.0 mm | 5 | 2101G-160IPD |
| 4.0 mm | 2.7 mm | 2.3 mm | 5 | 2101G-180IPD |

ERGO™ Side Cutting Pliers with Self Opening Dual-Component Handle and Phosphate Finish for Plastic



ergo



### 2101PG

| L      |   |            |
|--------|---|------------|
| 160 mm | 5 | 2101PG-160 |

PLASTIC

ERGO™ Side Cutting Pliers with Self Opening Dual-Component Handle and Nickel-Chrome Finish



ergo



### 2101GC

| Cu     | Fe+    | Plato  |   |              |
|--------|--------|--------|---|--------------|
| 3.5 mm | 1.8 mm | 1.6 mm | 5 | 2101GC-125IP |
| 3.7 mm | 2.0 mm | 1.8 mm | 5 | 2101GC-140IP |
| 3.8 mm | 2.5 mm | 2.0 mm | 5 | 2101GC-160IP |
| 4.0 mm | 2.7 mm | 2.3 mm | 5 | 2101GC-180IP |

Side Cutting Pliers with Mono Material Handles and Phosphate Finish



### 2101D

| Cu     | Fe+    | Plato  |   |             |
|--------|--------|--------|---|-------------|
| 3.5 mm | 1.8 mm | 1.6 mm | 5 | 2101D-125   |
| 3.7 mm | 2.0 mm | 1.8 mm | 5 | 2101D-140   |
| 3.8 mm | 2.5 mm | 2.0 mm | 5 | 2101D-160   |
| 4.0 mm | 2.7 mm | 2.3 mm | 5 | 2101D-180   |
| 3.5 mm | 1.8 mm | 1.6 mm | 5 | 2101D-125IP |
| 3.7 mm | 2.0 mm | 1.8 mm | 5 | 2101D-140IP |
| 3.8 mm | 2.5 mm | 2.0 mm | 5 | 2101D-160IP |
| 4.0 mm | 2.7 mm | 2.3 mm | 5 | 2101D-180IP |

ERGO™ Heavy Duty Side Cutting Pliers with Self Opening Dual-Component Handle and Phosphate Finish



ergo



### 21HDG

| Fe+    | Plato  | L      |   |             |
|--------|--------|--------|---|-------------|
| 2.3 mm | 2.1 mm | 140 mm | 5 | 21HDG-140   |
| 2.7 mm | 2.3 mm | 160 mm | 5 | 21HDG-160   |
| 3.3 mm | 2.8 mm | 180 mm | 5 | 21HDG-180   |
| 3.3 mm | 2.8 mm | 200 mm | 5 | 21HDG-200   |
| 2.3 mm | 2.1 mm | 140 mm | 5 | 21HDG-140IP |
| 2.7 mm | 2.3 mm | 160 mm | 5 | 21HDG-160IP |
| 3.3 mm | 2.8 mm | 180 mm | 5 | 21HDG-180IP |
| 3.3 mm | 2.8 mm | 200 mm | 5 | 21HDG-200IP |

ERGO™ 14° Side Cutting Pliers with Self Opening Dual-Component Handle and Phosphate Finish



**21HDG-A**

| Icon   | Icon   | L      | Icon | Icon       |
|--------|--------|--------|------|------------|
| 2.2 mm | 2.0 mm | 140 mm | 5    | 21HDG-140A |
| 2.5 mm | 2.3 mm | 160 mm | 5    | 21HDG-160A |
| 2.7 mm | 2.5 mm | 180 mm | 5    | 21HDG-180A |
| 3.2 mm | 3.0 mm | 200 mm | 5    | 21HDG-200A |

ERGO™ Heavy Duty Side Cutting Pliers with Self Opening Dual-Component Handle and Chrome Finish



**21HDGC**

| Icon   | Icon   | L      | Icon | Icon         |
|--------|--------|--------|------|--------------|
| 2.2 mm | 2.2 mm | 140 mm | 5    | 21HDGC-140IP |
| 2.5 mm | 2.5 mm | 160 mm | 5    | 21HDGC-160IP |
| 2.8 mm | 2.8 mm | 180 mm | 5    | 21HDGC-180IP |
| 3.2 mm | 3.0 mm | 200 mm | 5    | 21HDGC-200IP |

Heavy Duty Side Cutting Pliers with Mono Material Handles and Phosphate Finish



**21HDD**

| Icon   | Icon   | L      | Icon | Icon        |
|--------|--------|--------|------|-------------|
| 2.2 mm | 2.2 mm | 140 mm | 5    | 21HDD-140   |
| 2.5 mm | 2.5 mm | 160 mm | 5    | 21HDD-160   |
| 2.8 mm | 2.8 mm | 180 mm | 5    | 21HDD-180   |
| 3.2 mm | 3.0 mm | 200 mm | 5    | 21HDD-200   |
| 2.2 mm | 2.2 mm | 140 mm | 5    | 21HDD-140IP |
| 2.5 mm | 2.5 mm | 160 mm | 5    | 21HDD-160IP |
| 2.8 mm | 2.8 mm | 180 mm | 5    | 21HDD-180IP |
| 3.2 mm | 3.0 mm | 200 mm | 5    | 21HDD-200IP |

Power Cutters with Dual-Component Handle and Phosphate Finish



**1520G**

| Icon   | L      | Icon | Icon      |
|--------|--------|------|-----------|
| 3.8 mm | 210 mm | 5    | 1520 G    |
| 3.8 mm | 210 mm | 5    | 1520 G IP |

Power Cutters with PVC Coated Handles and Phosphate Finish



**1520D**

| Icon   | L      | Icon | Icon   |
|--------|--------|------|--------|
| 3.8 mm | 205 mm | 5    | 1520 D |

ERGO™ Compact Side Cutting Pliers with Dual-Component Handle and Phosphate Finish



**4130, 4131**



| Icon       | L      | Icon | Icon |
|------------|--------|------|------|
| 0.3-1.5 mm | 120 mm | 3    | 4130 |
| 0.3-1.5 mm | 120 mm | 3    | 4131 |



Compact Oval Head Side Cutters with Orange PVC Handle



**C3140**

|  |  |  |         |
|---|---|---|---------|
| 0,4-2,0 mm  | 130 mm  | 10  | C3140   |
| 0,4-2,0 mm  | 130 mm  | 10  | C3140IP |

Side Cutting Pliers with PVC Coated Handles and Phosphate Finish



**2100PD**



|  |  |  |  |            |
|---|---|---|---|------------|
| 1.8 mm  | 3.0 mm  | 150 mm  | 5   | 2100PD-150 |

PLASTIC

Compact Side Cutting Pliers with Orange PVC Handle





**C3330**

|  |  |  |         |
|---|---|---|---------|
| 0,3-1,6 mm  | 115 mm  | 10  | C3330   |
| 0,3-1,6 mm  | 115 mm  | 10  | C3330IP |

Side Cutting Pliers with Dual-Component Handle and Polished Finish





**2171G**

|  |  |  |  |           |
|---|---|---|---|-----------|
| 2.5 mm  | 1.6 mm  | 1.5 mm  | 5   | 2171G-140 |
| 2.5 mm  | 1.6 mm  | 1.5 mm  | 5   | 2171G-160 |
| 2.5 mm  | 1.6 mm  | 1.5 mm  | 5   | 2171G-180 |

Compact Tapered and Relieved Head Side Cutters with Orange PVC Handle



**C3330R/C3340R**

|  |  |  |           |
|---|---|---|-----------|
| 0,3-1,25 mm   | 115 mm  | 10  | C3330R    |
| 0,3-1,25 mm   | 115 mm  | 10  | C3330R IP |
| 0,4-1,6 mm  | 130 mm  | 10  | C3340R    |
| 0,4-1,6 mm  | 130 mm  | 10  | C3340R IP |

Side Cutting Pliers with Cellulose Acetate Handles and Nickel-Chrome Finish For Steel Wire



**2666NB-2676NB**

|  |  |  |  |         |
|---|---|---|---|---------|
| 2.7 mm  | 2.0 mm  | 160 mm  | 1   | 2674 NB |

Side Cutting Pliers with Cellulose Acetate Handles and Nickel-Chrome Finish For Piano wire



**2667B-2678B**

| 3.7 mm | 2.0 mm | 2.0 mm | 1 | 2676 B |
|--------|--------|--------|---|--------|
| 4.0 mm | 2.5 mm | 2.5 mm | 1 | 2678 B |

| 0.1-1.0 mm  | Ultra-flush | 110 mm   | 1 | 2646 AK |
|-------------|-------------|----------|---|---------|
| 0.2-1.25 mm | Ultra-flush | 112.5 mm | 1 | 2666 FK |
| 0.4-2.0 mm  | Micro-bevel | 125 mm   | 1 | 2648    |
| 0.3-1.6 mm  | Ultra-flush | 125 mm   | 1 | 2648 A  |

Diagonal Cutters with Oval Head



**2646M - 2649**

| 0.1-0.8 mm  | Flush       | 108 mm   | 1 | 2646 M  |
|-------------|-------------|----------|---|---------|
| 0.2-1.25 mm | Micro-bevel | 110 mm   | 1 | 2646 R  |
| 0.2-1.25 mm | Micro-bevel | 110 mm   | 1 | 2646 RK |
| 0.1-1.0 mm  | Flush       | 110 mm   | 1 | 2646 RA |
| 0.3-1.6 mm  | Micro-bevel | 112.5 mm | 1 | 2666    |
| 0.4-2.0 mm  | Micro-bevel | 125 mm   | 1 | 2649    |

ERGO™ 20° Oblique Cutters



**4231**

| 0.3-1.25 mm | 119 mm | 3 | 4231 |
|-------------|--------|---|------|

Diagonal Cutters with Tapered Head



**2646 - 2648A**

| 0.2-1.25 mm | Micro-bevel | 110 mm | 1 | 2646   |
|-------------|-------------|--------|---|--------|
| 0.2-1.25 mm | Micro-bevel | 110 mm | 1 | 2646 K |
| 0.1-1.0 mm  | Ultra-flush | 110 mm | 1 | 2646 A |

ERGO™ 45° Oblique Cutters



**4239**

| 0.3-1.0 mm | 129 mm | 3 | 4239 |
|------------|--------|---|------|





45° Oblique Cutters with PVC Coated Handles and Phosphate Finish



**2145PD**

PLASTIC

|        |        |        |   |            |
|--------|--------|--------|---|------------|
|        |        |        |   |            |
| 3.0 mm | 1.8 mm | 154 mm | 5 | 2145PD-150 |

End Cutting Pliers with Bi-Material Handles and Chrome Finish



**527 GC**

|                  |                  |        |                          |
|------------------|------------------|--------|--------------------------|
|                  |                  |        |                          |
| 2.0 mm<br>2.5 mm | 160 mm<br>200 mm | 3<br>3 | 527 GC-160<br>527 GC-200 |

45° Oblique Cutters with Long Head



**2787F**

|            |       |          |   |        |
|------------|-------|----------|---|--------|
|            |       |          |   |        |
| 0.2-1.0 mm | Flush | 117.5 mm | 1 | 2787 F |

End Cutting Pliers with PVC Handles and Phosphate Finish



**527D**

|                |                  |        |                        |
|----------------|------------------|--------|------------------------|
|                |                  |        |                        |
| 2 mm<br>2.5 mm | 160 mm<br>200 mm | 5<br>5 | 527 D-160<br>527 D-200 |

45° Oblique Cutters with Relieved Long Head



**2787G**

|            |       |          |   |        |
|------------|-------|----------|---|--------|
|            |       |          |   |        |
| 0.2-0.8 mm | Flush | 117.5 mm | 1 | 2787 G |

High Leverage End Cutting/Fencing Pliers with PVC Coated Handles and Black Epoxy Finish





**2339D**

|                                      |                                      |                  |  |
|--------------------------------------|--------------------------------------|------------------|--|
|                                      |                                      |                  |  |
| 2.2 mm<br>2.2 mm<br>4.5 mm<br>4.5 mm | 220 mm<br>220 mm<br>300 mm<br>300 mm | 3<br>5<br>5<br>6 | 2339 D<br>2339 DIP<br>2339D-300<br>2339D-300IP |

High Leverage End Cutting/Fencing Pliers with Black Epoxy Finish



**2339**

|  |  |  |
|---|---|---|
| 2.2 mm  | 220 mm  | 5 2339-220  |
| 2.2 mm  | 220 mm  | 5 2339-220IP  |
| 2.5 mm  | 250 mm  | 5 2339-250IP  |
| 3.0 mm  | 280 mm  | 5 2339-280IP  |
| 4.5 mm  | 300 mm  | 6 2339-300IP  |

Compact End Cutting Pliers with Orange PVC Handle





**C3230**

|  |  |
|---|---|
| 109 mm  | 10 C3230  |
| 109 mm  | 10 C3230IP  |

Pincers with PVC Handles and Black Epoxy Finish



**541D**

|  |  |  |
|---|---|---|
| 2.0 mm  | 150 mm  | 5 541 D-150   |
| 2.0 mm  | 180 mm  | 5 541D-180  |
| 2.5 mm  | 200 mm  | 5 541 D-200   |
| 2.5 mm  | 225 mm  | 5 541D-225  |
| 2.5 mm  | 250 mm  | 5 541 D-250   |

90° Side Cutting Pliers with PVC Coated Handles and Phosphate Finish



**2190PD**



|  |  |  |  |
|---|---|---|---|
| 1.8 mm  | 3.0 mm  | 143 mm  | 5 2190PD-150  |

PLASTIC

High Leverage End Cutting/Fencing Pliers with Phosphate Finish



**1519D**

|  |  |  |
|---|---|---|
| 2.5 mm  | 230 mm  | 3 1519 D  |
|   |   | 1 1519-9  |

End Cutters with Synthetic Handles and Mirror Finish



**2656/2656A**

|  |  |  |  |
|---|---|---|---|
| 0.35 - 0.8 mm   | Micro   | 115 mm  | 1 2656  |



Cable Cutting/Stripping Pliers with PVC Coated Handles for Cu and Al Cables



**2233D**

| Icon  | Icon     | Icon   | Icon | Icon        |
|-------|----------|--------|------|-------------|
|       |          |        |      |             |
| 10 mm | 50/35 mm | 160 mm | 5    | 2233 D-160  |
| 13 mm | 70/50 mm | 200 mm | 5    | 2233 D-200  |
| 16 mm | 95/70 mm | 240 mm | 5    | 2233 D-240  |
| 10 mm | 50/35 mm | 160 mm | 5    | 2233D-160IP |
| 13 mm | 70/50 mm | 200 mm | 5    | 2233D-200IP |
| 16 mm | 95/70 mm | 240 mm | 5    | 2233D-240IP |

Cable Cutters with Epoxy Painted Handles for Cu, Al and Steel Cables



**2720**

| Icon  | Icon             | Icon | Icon            |
|-------|------------------|------|-----------------|
|       |                  |      |                 |
| 42 mm | 600 mm<br>163 mm | 1    | 2720<br>2720-SH |

Cable Cutters with Epoxy Painted Handles for Cu and Al Cables 30 mm



**2520**

| Icon   | Icon   |
|--------|--------|
|        |        |
| 550 mm | 1 2520 |

Cable Cutters with Elastomer Handles for Solid Materials and Multi Wire Cables



**2235-160**

| Icon   | Icon       |
|--------|------------|
|        |            |
| 165 mm | 1 2235-160 |

Cable Cutters with Epoxy Painted Handles for Cu and Al Cables 42 mm



**2620-80**

| Icon  | Icon   | Icon | Icon    |
|-------|--------|------|---------|
|       |        |      |         |
| 42 mm | 800 mm | 1    | 2620-80 |

Cable Cutters with PVC Coated Handles for Cu and Al Cables



**2804-2805**

| Icon           | Icon           | Icon             | Icon                 |
|----------------|----------------|------------------|----------------------|
|                |                |                  |                      |
| 16 mm<br>22 mm | 34 mm<br>52 mm | 250 mm<br>280 mm | 1 2804<br>1 2805-280 |

Cable Cutters with PVC Coated Handles for Multi Wire and Flexible Conductors



**2800N-2801N**

| 0-10 mm | 170 mm | 1 2800 N |
|---------|--------|----------|
| 0-15 mm | 230 mm | 1 2801 N |

Diagonal Bolt Cutters with Phosphate Finish



**4560-210**

| 250 mm | 1 4560-210 |
|--------|------------|

Bolt Cutters with Comfort Grip Handles and Phosphate Finish



**4559**

| 6 mm  | 5 mm  | 4 mm  | 1 4559-12 |
|-------|-------|-------|-----------|
| 8 mm  | 7 mm  | 6 mm  | 8 4559-18 |
| 10 mm | 9 mm  | 8 mm  | 6 4559-24 |
| 13 mm | 10 mm | 9 mm  | 5 4559-30 |
| 15 mm | 12 mm | 11 mm | 3 4559-36 |
| 15 mm | 12 mm | 11 mm | 2 4559-42 |

**COMBINATION PLIERS**

ERGO™ Combination Pliers with Self-Opening Dual-Component Handles and Phosphate Finish



**2628G**

| 1.8 mm | 2.0 mm | 160 mm | 5 2628 G-160   |
|--------|--------|--------|----------------|
| 2.0 mm | 2.5 mm | 180 mm | 5 2628 G-180   |
| 2.5 mm | 3.0 mm | 200 mm | 5 2628 G-200   |
| 1.8 mm | 2.0 mm | 160 mm | 5 2628 G-160IP |
| 2.0 mm | 2.5 mm | 180 mm | 5 2628 G-180IP |
| 2.5 mm | 3.0 mm | 200 mm | 5 2628G-200IP  |

Spare Cutting Heads for 4559 Range Bolt Cutters



**4559 JC**

| 285 g  | 1 4559-12A JC |
|--------|---------------|
| 600 g  | 1 4559-18B JC |
| 930 g  | 1 4559-24B JC |
| 1260 g | 1 4559-30B JC |
| 2180 g | 1 4559-36B JC |
| 3025 g | 1 4559-42A JC |

ERGO™ Combination Pliers with Self-Opening Dual-Component Handles and Chrome Finish



**2628GC**

| 2.0 mm | 1.8 mm | 160 mm | 5 2628 GC-160IP |
|--------|--------|--------|-----------------|
| 2.5 mm | 2.0 mm | 180 mm | 5 2628 GC-180IP |
| 3.0 mm | 2.5 mm | 200 mm | 5 2628 GC-200IP |



ERGO™ Reinforced Combination Pliers with Self-Opening Dual-Component Handles and Chrome Finish



ergo®



**2630GC**

| Plano  | Fe+    | L      | Icons          |
|--------|--------|--------|----------------|
| 1.8 mm | 2.0 mm | 160 mm | 5 2630GC-160IP |
| 2.0 mm | 2.5 mm | 180 mm | 5 2630GC-180IP |
| 2.5 mm | 3.0 mm | 200 mm | 5 2630GC-200IP |

Reinforced Combination Pliers with Monomaterial Handles and Chrome Finish



**2630DC**

| Fe+    | Plano  | L      | Icons          |
|--------|--------|--------|----------------|
| 2.0 mm | 1.8 mm | 160 mm | 5 2630DC-160IP |
| 2.5 mm | 2.0 mm | 180 mm | 5 2630DC-180IP |
| 3.0 mm | 2.5 mm | 200 mm | 5 2630DC-200IP |

ERGO™ Combi-Snipe Pliers with Self-Opening Dual-Component Handles and Phosphate Finish



ergo®



**2629G**

| L      | Fe+    | Plano  | Icons         |
|--------|--------|--------|---------------|
| 160 mm | 2.0 mm | 1.8 mm | 5 2629G-160   |
| 180 mm | 3.0 mm | 2.5 mm | 5 2629G-180   |
| 200 mm | 2.5 mm | 2.0 mm | 5 2629G-200   |
| 160 mm | 2.5 mm | 2.0 mm | 5 2629G-160IP |
| 180 mm | 2.0 mm | 1.8 mm | 5 2629G-180IP |
| 200 mm | 3.0 mm | 2.5 mm | 5 2629G-200IP |

Universal Combination Pliers with PVC Coated Handles



**2640D**

| Cu     | Fe     | Fe+    | Icons        |
|--------|--------|--------|--------------|
| 3.0 mm | 2.7 mm | 2.5 mm | 10 2640D-160 |
| 3.0 mm | 2.7 mm | 2.5 mm | 5 2640D-180  |
| 3.5 mm | 3.0 mm | 2.5 mm | 5 2640D-200  |

Combination Pliers with Monomaterial Handles and Phosphate Finish



**2628D**

| Fe+    | Plano  | L      | Icons        |
|--------|--------|--------|--------------|
| 2.0 mm | 1.8 mm | 160 mm | 5 2628 D-160 |
| 2.5 mm | 2.0 mm | 180 mm | 5 2628 D-180 |
| 3.0 mm | 2.5 mm | 200 mm | 5 2628 D-200 |

High Leverage Universal Combination Pliers with PVC Coated Handles



**2688D**

| Fe+    | Fe     | Cu     | Icons       |
|--------|--------|--------|-------------|
| 2.5 mm | 3.0 mm | 3.5 mm | 3 2688D-250 |



Combination Pliers with Dual-Component Handles



**2678G**

| 1.7 mm | 1.3 mm | 160 mm | 5 | 2678 G-160 |
|--------|--------|--------|---|------------|
| 2.0 mm | 1.4 mm | 180 mm | 5 | 2678 G-180 |
| 2.5 mm | 1.5 mm | 205 mm | 5 | 2678 G-200 |

ERGO™ Long Snipe Nose Pliers with Self-Opening Dual-Component Handles and Chrome Finish



**2430GC**

| 2.5 mm | 1.8 mm | 1.4 mm | 5 | 2430 GC-140 IP |
|--------|--------|--------|---|----------------|
| 3.0 mm | 1.8 mm | 1.6 mm | 5 | 2430 GC-160 IP |
| 3.0 mm | 1.8 mm | 1.6 mm | 5 | 2430 GC-200 IP |

2 Position Combination Pliers with Lacquered Finish



**2970 G-200**

| 200 mm | 5 | 2970G-200 |
|--------|---|-----------|

Long Snipe Nose Pliers with Monomaterial Handles and Phosphate Finish



**2430D**

| 2.5 mm | 1.8 mm | 1.4 mm | 5 | 2430 D-140    |
|--------|--------|--------|---|---------------|
| 3.0 mm | 1.8 mm | 1.6 mm | 5 | 2430 D-160    |
| 3.0 mm | 1.8 mm | 1.6 mm | 5 | 2430 D-200    |
| 2.5 mm | 1.8 mm | 1.4 mm | 5 | 2430 D-140 IP |
| 3.0 mm | 1.8 mm | 1.6 mm | 5 | 2430 D-160 IP |
| 3.0 mm | 1.8 mm | 1.6 mm | 5 | 2430 D-200 IP |

**GRIPPING PLIERS**

ERGO™ Long Snipe Nose Pliers with Self-Opening Dual-Component Handles and Phosphate Finish



**2430G**

| 2.5 mm | 1.8 mm | 1.4 mm | 5 | 2430 G-140    |
|--------|--------|--------|---|---------------|
| 3.0 mm | 1.8 mm | 1.6 mm | 5 | 2430 G-160    |
| 3.0 mm | 1.8 mm | 1.6 mm | 5 | 2430 G-200    |
| 2.5 mm | 1.8 mm | 1.4 mm | 5 | 2430 G-140 IP |
| 3.0 mm | 1.8 mm | 1.6 mm | 5 | 2430 G-160 IP |
| 3.0 mm | 1.8 mm | 1.6 mm | 5 | 2430 G-200 IP |

ERGO™ Long Snipe Nose Pliers without Cutting Edge, with Self-Opening Dual-Component Handles and Phosphate Finish



**2431G**

| 125 mm | 5 | 2431G-125   |
|--------|---|-------------|
| 140 mm | 5 | 2431G-140   |
| 160 mm | 5 | 2431G-160   |
| 180 mm | 5 | 2431G-180   |
| 125 mm | 5 | 2431G-125IP |
| 140 mm | 5 | 2431G-140IP |
| 160 mm | 5 | 2431G-160IP |
| 180 mm | 5 | 2431G-180IP |



ERGO™ Compact Snipe Nose Pliers with Dual-Component Handles and Phosphate Finish



ergo



**4830, 4831**



135 mm  
135 mm



3 4830  
3 4831

Snipe Nose Pliers with Synthetic Handles and Mirror Polish Finish



**2656S**



132 mm



1 2656 S

Compact Snipe Nose Pliers with Orange PVC Handle



**C3830/C3840**



121 mm  
121 mm  
144 mm  
144 mm



10 C3830  
10 C3830IP  
10 C3840  
10 C3840IP

Snipe Nose Pliers with Dual-Component Handles and Lacquered Finish



**2470G**



3.0 mm  
3.0 mm



1.5 mm  
1.5 mm



1.0 mm  
1.0 mm

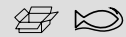

5 2470 G-160  
5 2470 G-200

Compact Snipe Needle Nose Pliers with Orange PVC Handle



**C3630/C3640**



130 mm  
130 mm  
145 mm  
145 mm



10 C3630  
10 C3630IP  
10 C3640  
10 C3640IP

Extra Long Snipe Nose Pliers with PVC Coated Handles and Fine Polish Finish



**158-N**



280 mm



12 158-N

ERGO™ 45° Bent Tip Snipe Nose Pliers with Self-Opening Dual-Component Handles and Phosphate Finish



ergo®



**2427G**

| 3.0 mm | 1.8 mm | 1.6 mm | 5 | 2427 G-160    |
|--------|--------|--------|---|---------------|
| 3.0 mm | 1.8 mm | 1.6 mm | 5 | 2427 G-200    |
| 3.0 mm | 1.8 mm | 1.6 mm | 5 | 2427 G-160 IP |
| 3.0 mm | 1.8 mm | 1.6 mm | 5 | 2427 G-200 IP |

ERGO™ 60° Bent Tip Snipe Nose Pliers with Dual-Component Handles and Phosphate Finish



ergo®



**4833**

| 130 mm | 3 | 4833 |
|--------|---|------|

ERGO™ 45° Bent Tip Snipe Nose Pliers with Self-Opening Dual-Component Handles and Chrome Finish



ergo®



**2427GC**

| 3.0 mm | 1.8 mm | 1.6 mm | 5 | 2427 GC-160IP |
|--------|--------|--------|---|---------------|
| 3.0 mm | 1.8 mm | 1.6 mm | 5 | 2427 GC-200IP |

Compact Needle Snipe Nose Pliers with 45° Bent Tip and Orange PVC Handle



**C3745**

| 141 mm | 10 | C3745   |
|--------|----|---------|
| 141 mm | 10 | C3745IP |

45° Bent Tip Snipe Nose Pliers with Monomaterial Handles and Phosphate Finish



**2427D**

| 3.0 mm | 1.8 mm | 1.6 mm | 5 | 2427 D-160 |
|--------|--------|--------|---|------------|
| 3.0 mm | 1.8 mm | 1.6 mm | 5 | 2427 D-200 |

Compact 90° Bent Tip Snipe Nose Pliers with Orange PVC Handle



**C3790**

| 125 mm | 10 | C3790   |
|--------|----|---------|
| 125 mm | 10 | C3790IP |



60° Bent Tip Snipe Nose Pliers with Synthetic Handles and Mirror Polished Finish



**2656R**

|        |   |        |
|--------|---|--------|
|        |   |        |
| 129 mm | 1 | 2656 R |

45° Bent Tip Snipe Nose Pliers with Dual-Component Handles and Lacquered Finish



**2477G-200**

|        |        |      |   |            |
|--------|--------|------|---|------------|
|        |        |      |   |            |
| 3.0 mm | 1.5 mm | 1 mm | 5 | 2477G-160  |
| 3.0 mm | 1.5 mm | 1 mm | 5 | 2477 G-200 |

35° Bent Tip Extra Long Snipe Nose Pliers with PVC Coated Handles and Fine Polished Finish



**158-NB**

|        |    |        |
|--------|----|--------|
|        |    |        |
| 270 mm | 12 | 158-NB |

ERGO™ Short Flat Nose Pliers with Self-Opening Dual-Component Handles and Phosphate Finish



**2420G**

|        |   |             |
|--------|---|-------------|
|        |   |             |
| 125 mm | 5 | 2420 G-125  |
| 125 mm | 5 | 2420G-125IP |

ERGO™ Long Flat Nose Pliers with Self-Opening Dual-Component Handles and Phosphate Finish



**2421G**

|        |   |               |
|--------|---|---------------|
|        |   |               |
| 140 mm | 5 | 2421 G-140    |
| 160 mm | 5 | 2421 G-160    |
| 180 mm | 5 | 2421 G-180    |
| 140 mm | 5 | 2421 G-140IP  |
| 160 mm | 5 | 2421 G-160 IP |
| 180 mm | 5 | 2421 G-180 IP |

ERGO™ Long Flat Nose Pliers with Self-Opening Dual-Component Handles and Chrome Finish



**2421GC**

|        |   |              |
|--------|---|--------------|
|        |   |              |
| 140 mm | 5 | 2421GC-140IP |
| 160 mm | 5 | 2421GC-160IP |
| 180 mm | 5 | 2421GC-180IP |

Long Flat Nose Pliers with Monomaterial Handles and Phosphate Finish



**2421D**

|        |                |
|--------|----------------|
|        |                |
| 140 mm | 5 2421 D-140IP |
| 160 mm | 5 2421 D-160IP |
| 180 mm | 5 2421 D-180IP |

Compact Flat Nose Pliers with Orange PVC Handle



**C3430**

|        |            |
|--------|------------|
|        |            |
| 129 mm | 10 C3430   |
| 129 mm | 10 C3430IP |

ERGO™ Connector Pliers with Self-Opening Dual-Component Handles and Phosphate Finish



**7835G**

|        |              |
|--------|--------------|
|        |              |
| 3.0 mm | 5 7835 G-160 |
| 1.8 mm |              |
| 1.6 mm |              |

Flat Nose Pliers with Synthetic Handles and Mirror Polish Finish



**2646MF**

|        |           |
|--------|-----------|
|        |           |
| 120 mm | 1 2646 MF |

ERGO™ Flat Nose Pliers with Dual-Component Handles and Phosphate Finish



**4430**

|        |        |
|--------|--------|
|        |        |
| 135 mm | 3 4430 |

Long Flat Nose Pliers with Dual-Component Handles and Lacquered Finish



**2471G**

|        |              |
|--------|--------------|
|        |              |
| 165 mm | 5 2471 G-160 |





Flat Nose Nut Pliers with PVC Coated Handles and Phosphate Finish



**2979D**



180 mm



5 2979 D-180

ERGO™ Round Nose Pliers with Self-Opening Dual-Component Handles and Phosphate Finish



**2521G**



140 mm  
160 mm  
140 mm  
160 mm



5 2521 G-140  
5 2521G-160  
5 2521G-140IP  
5 2521 G-160 IP

Round Nose Pliers with Monomaterial Handles and Phosphate Finish



**2521D**



140 mm  
160 mm



5 2521D-140IP  
5 2521D-160IP

ERGO™ Compact Round Nose Pliers with Dual-Component Handles and Phosphate Finish



**4530**



135 mm



3 4530

Compact Round Nose Pliers with Orange PVC Handle



**C3530**



127 mm  
127 mm



10 C3530  
10 C3530IP

Chain Nose Pliers with Synthetic Handle



**2646MS**



120 mm



1 2646 MS

## WATERPUMP PLIERS

ERGO™ Slip Joint Water Pump Pliers with Dual-Component Handles and Phosphate Finish



### 8223 - 8226



| max    | L |   |         |
|--------|---|---|---------|
| 210 mm |   | 4 | 8223    |
| 250 mm |   | 4 | 8224    |
| 315 mm |   | 4 | 8225    |
| 400 mm |   | 1 | 8226    |
| 210 mm |   | 4 | 8223 IP |
| 250 mm |   | 4 | 8224 IP |
| 315 mm |   | 4 | 8225 IP |

ERGO™ Slip Joint Water Pump Pliers with Dual-Component Handles and Chrome Finish



### 8224/8225C



| L      |  |   |         |
|--------|--|---|---------|
| 250 mm |  | 4 | 8224CIP |
| 315 mm |  | 4 | 8225CIP |

ERGO™ Extra Wide Jaw Slip Joint Water Pump Pliers with Dual-Component Handles and Phosphate finish



### 8231



| max   | L      |   |         |
|-------|--------|---|---------|
| 51 mm | 225 mm | 4 | 8231    |
| 51 mm | 225 mm | 4 | 8231 IP |

Quick Adjust Slip Joint Water Pump Pliers with Phosphate Finish



### 7223-7225

| max   | L      |   |        |
|-------|--------|---|--------|
| 45 mm | 200 mm | 4 | 7223   |
| 63 mm | 250 mm | 4 | 7224   |
| 70 mm | 300 mm | 8 | 7225   |
| 45 mm | 200 mm | 8 | 7223IP |
| 63 mm | 250 mm | 4 | 7224IP |
| 70 mm | 300 mm | 4 | 7225IP |

Quick-Adjust Water Pump Pliers with PVC Handle



### 7223D 7225D

|    | L      |   |          |
|----|--------|---|----------|
| 16 | 200 mm | 8 | 7223D    |
| 25 | 300 mm | 4 | 7225D    |
| 16 | 200 mm | 8 | 7223D IP |
| 25 | 300 mm | 4 | 7225D IP |

Box Joint Water Pump Pliers with Dual-Component Handle



### 6224

|    | L      |   |      |
|----|--------|---|------|
| 11 | 250 mm | 4 | 6224 |



Box Joint Water Pump Pliers with PVC Handle



**6221D-6225D**

| 6  | 125 mm | 10 | 6221D    |
|----|--------|----|----------|
| 8  | 150 mm | 10 | 6222D    |
| 10 | 200 mm | 8  | 6223D    |
| 11 | 250 mm | 5  | 6224D    |
| 13 | 300 mm | 10 | 6225D    |
| 6  | 125 mm | 10 | 6221D IP |
| 8  | 150 mm | 10 | 6222D IP |
| 10 | 200 mm | 8  | 6223D IP |
| 11 | 250 mm | 5  | 6224D IP |
| 13 | 300 mm | 5  | 6225D IP |

Screw Joint Water Pump Pliers with PVC Coated Handles and Chrome Finish



**5223 - 5226 DC**

| 105 mm | 400 mm | 1 | 5226 DC |
|--------|--------|---|---------|

Box Joint Water Pump Pliers with Dual-Component Handles and Phosphate Finish



**2971G**

| 35 mm | 250 mm | 5 | 2971G-250 |
|-------|--------|---|-----------|

Connector Pliers with PVC Coated Handles and Chrome Finish



**2650**

| 65 mm | 235 mm | 1 | 2650   |
|-------|--------|---|--------|
|       | 235 mm | 1 | 2650 B |

Screw Joint Water Pump Pliers with PVC Coated Handles and Phosphate Finish



**221 D - 225 D**

| 117 mm | 5 | 221 D |
|--------|---|-------|
| 150 mm | 5 | 222 D |
| 192 mm | 5 | 223 D |
| 240 mm | 5 | 224 D |
| 305 mm | 5 | 225 D |

Box Joint Water Pump Pliers Set - 3 Pcs



**622-3P**

| 110 x 50 x 390 mm | 3 | 1260 g | 1 | 622-3P |
|-------------------|---|--------|---|--------|

6223D, 6224D, 6225D



## Water Pump Pliers Set - 3 Pcs



### 7224-622XD-3P

|                  |   |       |   |               |
|------------------|---|-------|---|---------------|
|                  |   |       |   |               |
| 75 x 50 x 260 mm | 3 | 813 g | 1 | 7224-622XD-3P |

6221D, 6224D

7224



## CIRCLIP PLIERS

### Internal Circlip Pliers with Straight Jaws and Phosphate Finish



### 2800

|           |        |        |   |          |
|-----------|--------|--------|---|----------|
|           |        |        |   |          |
| 8-13 mm   | 0.8 mm | 140 mm | 3 | 2800-140 |
| 12-25 mm  | 1.2 mm | 150 mm | 3 | 2800-150 |
| 19-60 mm  | 1.7 mm | 180 mm | 3 | 2800-180 |
| 40-100 mm | 2.2 mm | 225 mm | 3 | 2800-225 |
| 85-165 mm | 3.1 mm | 310 mm | 1 | 2800-300 |

### Internal Circlip Pliers with 90° Offset Jaws and Phosphate Finish



### 2890

|          |        |        |   |          |
|----------|--------|--------|---|----------|
|          |        |        |   |          |
| 8-15 mm  | 0.8 mm | 127 mm | 3 | 2890-125 |
| 12-25 mm | 1.2 mm | 127 mm | 3 | 2890-140 |
| 19-60 mm | 1.7 mm | 180 mm | 3 | 2890-180 |

|           |        |        |   |          |
|-----------|--------|--------|---|----------|
|           |        |        |   |          |
| 40-100 mm | 2.2 mm | 210 mm | 3 | 2890-210 |
| 85-165 mm | 3.1 mm | 300 mm | 1 | 2890-300 |

### Internal Circlip Pliers with Straight Jaws and Chrome Finish



### 2461

|           |            |        |   |          |
|-----------|------------|--------|---|----------|
|           |            |        |   |          |
| 8-25 mm   | 1.0-2.0 mm | 140 mm | 1 | 2461 C8  |
| 19-60 mm  | 2.0-2.5 mm | 180 mm | 1 | 2461 C19 |
| 40-100 mm | 2.5-3.5 mm | 255 mm | 1 | 2461 C40 |

### Internal Circlip Pliers with 90° Offset Jaws and Chrome Finish



### 2463

|           |            |        |   |          |
|-----------|------------|--------|---|----------|
|           |            |        |   |          |
| 8-25 mm   | 1.0-2.0 mm | 130 mm | 1 | 2463 D8  |
| 19-60 mm  | 2.0-2.5 mm | 170 mm | 1 | 2463 D19 |
| 40-100 mm | 2.5-3.5 mm | 210 mm | 1 | 2463 D40 |



External Circlip Pliers with Straight Jaws and Phosphate Finish



**2900**

| ⌀         | +      | L      | ⊠ | ⊡        |
|-----------|--------|--------|---|----------|
| 3-10 mm   | 0.8 mm | 140 mm | 3 | 2900-140 |
| 10-25 mm  | 1.2 mm | 150 mm | 3 | 2900-150 |
| 19-60 mm  | 1.7 mm | 180 mm | 3 | 2900-180 |
| 40-100 mm | 2.2 mm | 215 mm | 3 | 2900-215 |
| 85-165 mm | 3.1 mm | 300 mm | 1 | 2900-300 |

External Circlip Pliers with 90° Offset Jaws and Phosphate Finish



**2990**

| ⌀         | +      | L      | ⊠ | ⊡        |
|-----------|--------|--------|---|----------|
| 3-10 mm   | 0.8 mm | 12 mm  | 3 | 2990-125 |
| 10-25 mm  | 1.2 mm | 127 mm | 3 | 2990-140 |
| 19-60 mm  | 1.7 mm | 180 mm | 3 | 2990-180 |
| 40-100 mm | 2.2 mm | 200 mm | 3 | 2990-200 |
| 85-165 mm | 3.1 mm | 300 mm | 1 | 2990-300 |

External Circlip Pliers with Straight Jaws and Chrome Finish



**2464**

| ⌀         | +          | L      | ⊠ | ⊡        |
|-----------|------------|--------|---|----------|
| 3-10 mm   | 1.0-1.5 mm | 120 mm | 1 | 2464 A3  |
| 10-25 mm  | 1.5-2.0 mm | 120 mm | 1 | 2464 A10 |
| 19-60 mm  | 2.0-2.5 mm | 180 mm | 1 | 2464 A19 |
| 40-100 mm | 2.5-3.0 mm | 210 mm | 1 | 2464 A40 |

External Circlip Pliers with 90° Offset Jaws and Chrome Finish



**2466**

| ⌀         | +          | L      | ⊠ | ⊡        |
|-----------|------------|--------|---|----------|
| 3-10 mm   | 1.0-1.5 mm | 130 mm | 1 | 2466 B3  |
| 10-25 mm  | 1.5-2.0 mm | 130 mm | 1 | 2466 B10 |
| 19-60 mm  | 2.0-2.5 mm | 165 mm | 1 | 2466 B19 |
| 40-100 mm | 2.5-3.0 mm | 190 mm | 1 | 2466 B40 |

Internal and External Circlips Resettable Pliers



**2928**

| ⌀         | ⌀         | L      | ⊠ | ⊡        |
|-----------|-----------|--------|---|----------|
| 7-26 mm   | 3-26 mm   | 160 mm | 1 | 2928-160 |
| 10-51 mm  | 7-51 mm   | 200 mm | 1 | 2928-200 |
| 46-102 mm | 38-102 mm | 250 mm | 1 | 2928-250 |

Spare Tips for 2928 Series Resettable Circlips Pliers



**2928-1 - 4**

| ⊠        | ⊡        |
|----------|----------|
| 2928-160 | 1 2928-1 |
| 2928-200 | 1 2928-2 |
| 2928-250 | 1 2928-3 |
| 2928-250 | 1 2928-4 |



External Horseshoe Circlip Pliers with Chrome Finish



**2460**

|        |   |      |
|--------|---|------|
|        |   |      |
| 175 mm | 1 | 2460 |

External Horseshoe Circlip Pliers with Nickel-Chrome Finish and PVC Coated Handles



**2465D**

|        |   |           |
|--------|---|-----------|
|        |   |           |
| 200 mm | 1 | 2465D-200 |

Internal and External Circlip Pliers Set - 4 Pcs



**28-29/S4**

|       |   |          |
|-------|---|----------|
|       |   |          |
| 740 g | 1 | 28-29/S4 |

|          |  |
|----------|--|
| 2900-180 |  |
| 2800-180 |  |
| 2990-180 |  |
| 2890-180 |  |

Resettable Circlip Pliers Set - 3 Pcs



**9938**

|        |   |      |
|--------|---|------|
|        |   |      |
| 1640 g | 1 | 9938 |

2928-160, 2928-200, 2928-250

**WIRE STRIPPERS & DISMANTLING TOOLS**

ERGO™ Wire Stripping Pliers with Self-Opening Dual-Component Handles and Phosphate Finish



**2223G**

|          |        |   |            |
|----------|--------|---|------------|
|          |        |   |            |
| 0.5-5 mm | 165 mm | 5 | 2223 G-150 |



Wire Stripping Pliers with Monomaterial Handles and Phosphate Finish



**2223D**

|  |   |   |   |
|--|---|---|---|
|  |  |  |  |
| 0.5-5 mm   | 165 mm  | 5   | 2223 D-150  |

Automatic Wire Stripping Pliers with Built in Side Cutter and Integrated Scale







**3418 A**

|   |   |   |   |
|---|---|---|---|
|  |  |  |  |
| 20-10 AWG   | 0,5-6 mm <sup>2</sup>   | 3 mm  | 1 3418 A  |

Automatic Wire Stripping Pliers







**3416 B**

|  |   |   |   |
|--|---|---|---|
|  |  |  |  |
| 0,02-10 mm <sup>2</sup>  | 34-8 AWG  | 10  | 3416 B  |
|  |   | 10  | 3416 B SH   |

Rotating dismantling tool







**3520 B**

|   |   |   |   |
|---|---|---|---|
|  |  |  |  |
| 4,5-40 mm   | 167 mm  | 10  | 3520 B  |
|   |   | 10  | 3520 B SH   |

Automatic Wire Stripping Pliers



**3416 A**

|  |   |   |   |
|--|---|---|---|
|  |  |  |  |
| 0,2-6 mm <sup>2</sup>  | 24-10 AWG   | 6   | 3416 A  |
|  |   | 1   | 3416 A SH   |

Rotating dismantling tool



**3520 A**

|   |   |   |
|---|---|---|
|  |  |  |
| 0,5-6 mm <sup>2</sup>   | 1   | 3520 A  |
|   | 1   | 3520 A SH   |

Rotating dismantling tool. 3518ASH spare blade



**3518 A**

|         |        |                         |
|---------|--------|-------------------------|
|         |        |                         |
| 4-28 mm | 185 mm | 1 3518 A<br>1 3518 A SH |

Stripping Tool for PVC Data Cables



**3717 A**

|        |              |      |          |
|--------|--------------|------|----------|
|        |              |      |          |
| 115 mm | 4.5-10 mm mm | 28 g | 1 3717 A |

Universal dismantling tool with hidden knife



**3518 B**

|                       |        |          |
|-----------------------|--------|----------|
|                       |        |          |
| 0,5-6 mm <sup>2</sup> | 125 mm | 1 3518 B |

Wire Stripping Tools for Coaxial Cables



**3417 A**

|            |        |           |
|------------|--------|-----------|
|            |        |           |
| 4.8-7.5 mm | 110 mm | 12 3417 A |

Wire Stripping Pliers with Anti-Slip Handle



**3517 A**

|         |        |          |
|---------|--------|----------|
|         |        |          |
| 6-13 mm | 120 mm | 1 3517 A |

Precision stripping pliers for data cables



**3619 A**

|           |       |                           |
|-----------|-------|---------------------------|
|           |       |                           |
| 2,5-11 mm | 91 mm | 10 3619 A<br>10 3619 A SH |



Precision Stripping Tool



**3719 A**

|             |           |        |    |        |
|-------------|-----------|--------|----|--------|
|             |           |        |    |        |
| 0,12-0,8 mm | 36-20 AWG | 112 mm | 12 | 3719 A |

Insertion Tool for LSA Blocks



**3718 A**

|        |            |      |    |        |
|--------|------------|------|----|--------|
|        |            |      |    |        |
| 185 mm | 0,7-2,6 mm | 60 g | 12 | 3718 A |

Self-Adjusting Automatic Wire Stripping Pliers with Built in Wire Cutter



**3419 B**

|              |          |             |
|--------------|----------|-------------|
|              |          |             |
| 0.25-6.00 mm | 1 3419 B | 1 3419 B SH |

**CRIMPING PLIERS**

Crimping/Cutting/Stripping Pliers with Yellow Handle



**CR B 01**

|                           |            |        |    |         |
|---------------------------|------------|--------|----|---------|
|                           | <b>AWG</b> |        |    |         |
| 0.50-6.00 mm <sup>2</sup> | 20-10      | 220 mm | 60 | CR B 01 |

Crimping/Cutting/Stripping Pliers with Red Handle



**CR B 02**

|                           |            |        |    |         |
|---------------------------|------------|--------|----|---------|
|                           | <b>AWG</b> |        |    |         |
| 1.50-6.00 mm <sup>2</sup> | 14-10      | 220 mm | 60 | CR B 02 |

Crimping/Cutting/Stripping Pliers with Green Handle



**CR B 03**

|                           |            |        |    |         |
|---------------------------|------------|--------|----|---------|
|                           | <b>AWG</b> |        |    |         |
| 1.50-6.00 mm <sup>2</sup> | 14-10      | 220 mm | 60 | CR B 03 |

Crimping Pliers for Round Pattern Cable Connections 0.5-2.5 mm<sup>2</sup>



**CR B 05**

|                         |            |        |   |         |
|-------------------------|------------|--------|---|---------|
|                         | <b>AWG</b> |        |   |         |
| 0.5-2.5 mm <sup>2</sup> | 20-14      | 140 mm | 2 | CR B 05 |

Ratcheting Crimping Pliers for Insulated Connectors



**CR W 01**

|                         |            |        |   |         |
|-------------------------|------------|--------|---|---------|
|                         | <b>AWG</b> |        |   |         |
| 0.5-6.0 mm <sup>2</sup> | 20-10      | 225 mm | 1 | CR W 01 |

Crimping Pliers for Round Pattern Cable Connections 0.5-16 mm<sup>2</sup>



**CR B 06**

|                        |            |        |   |         |
|------------------------|------------|--------|---|---------|
|                        | <b>AWG</b> |        |   |         |
| 0.5-16 mm <sup>2</sup> | 20-6       | 220 mm | 2 | CR B 06 |

Ratcheting Crimping Pliers for Non-insulated Connectors



**CR W 02**

|                       |            |        |   |         |
|-----------------------|------------|--------|---|---------|
|                       | <b>AWG</b> |        |   |         |
| 20-10 mm <sup>2</sup> | 20-10      | 225 mm | 1 | CR W 02 |

Ratcheting Crimping Pliers for Insulated Connectors - Oval Profile



**CR OV 01**

|                         |            |        |   |          |
|-------------------------|------------|--------|---|----------|
|                         | <b>AWG</b> |        |   |          |
| 0.5-6.0 mm <sup>2</sup> | 20-10      | 256 mm | 1 | CR OV 01 |

Ratcheting Crimping Pliers for Open Plug Type Connectors



**CR W 03**

|                         |            |        |   |         |
|-------------------------|------------|--------|---|---------|
|                         | <b>AWG</b> |        |   |         |
| 0.5-6.0 mm <sup>2</sup> | 20-10      | 225 mm | 1 | CR W 03 |





Ratcheting Crimping Pliers for High Quality Crimping Connections



**CR W 04**

|                             |        |   |         |
|-----------------------------|--------|---|---------|
|                             |        |   |         |
| RG 58-59-62 mm <sup>2</sup> | 225 mm | 1 | CR W 04 |

Self-Adjusting Crimping Pliers - Square Profile



**CR SA S01**

|                         |            |        |   |           |
|-------------------------|------------|--------|---|-----------|
|                         | <b>AWG</b> |        |   |           |
| 0.14-10 mm <sup>2</sup> | 26-8       | 176 mm | 1 | CR SA S01 |

Ratcheting Crimping Pliers for Tubular Connectors 0.5 AWG-4.0 AWG



**CR W 05**

|            |        |   |         |
|------------|--------|---|---------|
| <b>AWG</b> |        |   |         |
| 0.5-4.0    | 225 mm | 1 | CR W 05 |

Self-Adjusting Crimping Pliers - Hexagonal Profile



**CR SA H01**

|                         |            |        |   |           |
|-------------------------|------------|--------|---|-----------|
|                         | <b>AWG</b> |        |   |           |
| 0.14-10 mm <sup>2</sup> | 26-8       | 176 mm | 1 | CR SA H01 |
| 0.14-16 mm <sup>2</sup> | 26-6       | 176 mm | 1 | CR SA H16 |

Ratcheting Crimping Pliers for Tubular Connectors 6 AWG-16 AWG



**CR W 06**

|            |        |   |         |
|------------|--------|---|---------|
| <b>AWG</b> |        |   |         |
| 6-16       | 225 mm | 1 | CR W 06 |

Self-Adjusting Crimping Pliers - Trapezoidal Profile



**CR SA T01**

|                         |            |        |   |           |
|-------------------------|------------|--------|---|-----------|
|                         | <b>AWG</b> |        |   |           |
| 0.14-10 mm <sup>2</sup> | 26-8       | 180 mm | 1 | CR SA T01 |

Heavy Duty Crimping Pliers for Non-insulated Connectors 600 mm



**CR L 01**

|                        |                       |        |   |         |
|------------------------|-----------------------|--------|---|---------|
|                        |                       |        |   |         |
| 10-120 mm <sup>2</sup> | 10-95 mm <sup>2</sup> | 600 mm | 1 | CR L 01 |

Heavy Duty Crimping Pliers for Non-insulated Connectors 360 mm



**CR L 02**

|                      |        |   |         |
|----------------------|--------|---|---------|
|                      |        |   |         |
| 6-50 mm <sup>2</sup> | 360 mm | 1 | CR L 02 |

Heavy Duty Crimping Pliers for Non-insulated Connectors 650 mm



**CR L 03**

|                        |        |   |         |
|------------------------|--------|---|---------|
|                        |        |   |         |
| 25-150 mm <sup>2</sup> | 650 mm | 1 | CR L 03 |

**PLIERS SETS**

ERGO™ Fine Mechanical Cutters and Pliers Set - 8 Pcs



**9733**

|                   |   |   |      |
|-------------------|---|---|------|
|                   |   |   |      |
| 30 x 215 x 215 mm | 8 | 1 | 9733 |

|            |  |
|------------|--|
| 4130, 4131 |  |
| 4239       |  |
| 4830       |  |
| 4530       |  |
| 4231       |  |
| 4430       |  |
| 4833       |  |

Compact Cutters and Pliers Set C3140, C3640 and C3830 - 3 Pcs



**C3901/3**

|   |   |         |
|---|---|---------|
|   |   |         |
| 3 | 1 | C3901/3 |

|         |  |
|---------|--|
| C3140IP |  |
| C3640IP |  |
| C3830IP |  |



Compact Cutters and Pliers Set C3330R, C3840 and C3745 - 3 Pcs



**C3902/3**



3

1 C3902/3

C3330R



C3840



C3745



Compact Pliers and Screwdrivers Set - 8 pcs



**C3903/2-6**



8

1 C3903/2-6

C3330R



C3840



700-1.5-50, 700-2-50, 700-2.5-50, 700-3-50



701-0-50, 701-1-75



ERGO™ Plumber's Set with 9031 Adjustable Wrench - 2 Pcs



**9031-8224**



2

693 g

3 9031-8224

**BAHCO**

9031



8224



ERGO™ Plumber's Set with 9072P Adjustable Wrench - 2 Pcs



**9873**



25 x 190 x 280 mm

2

1 9873

9072 P



8224



All Round Tool Set - 3 Pcs



**9853**



25 x 252 x 292 mm

3

1 9853

9071



2101G-160



8224



ERGO™ All Round Pliers Tool Set - 4 Pcs



**9897**



4

1030 g

1 9897

8224



2628 G-180



2101G-160



2430 G-160



ERGO™ All-Round Pliers Tool Set - 3 pcs



**9897G/3**



3

50 x 180 x 400 mm

788 g

1 9897G/3

2628 G-180



2101G-160



2430 G-200



**LOCKING PLIERS**

Grip Locking Pliers with Curved Jaws



**2951**



1.2 mm

140 mm

1 2951-140

2 mm

190 mm

1 2951-180

3 mm

235 mm

1 2951-250



4 mm

300 mm

1 2951-300

Self Grip Locking Pliers with Curved Jaws



**2953**



140 mm

1 2953-140

190 mm

1 2953-200

235 mm

1 2953-250

300 mm

1 2953-300

Grip Locking Pliers with Straight Jaws



**2958**



135 mm

1 2958-140

190 mm

1 2958-200

235 mm

1 2958-250

Grip Locking Pliers with Flat Jaws and Longitudinal Section



**2968**



205 mm

1 2968-190

235 mm

1 2968-235



Grip and Welding Pliers with Multipurpose Jaws



**2957**



250 mm



1 2957-250

Grip Locking Pliers with Parallel Jaws



**2955**



235 mm



1 2955-250

Grip Locking Pliers with Long and Slim Jaws



**2952**



155 mm

230 mm



1 2952-165

1 2952-235

Locking Chain Clamps with Nickel Finish



**2999**



230 mm

500 mm



1 2999-250

1 2999-SHN

Special Grips for Sheet Metals with Nickel Finish



**2967**



180 mm



1 2967-180

Chain Pipe Cutters with Chrome Finish



**2998**



240 mm

330 mm



1 2998-250

1 2998-SHN



### Table Locking Clamp



**2960**



280 mm



1 2960-280

### Self Adjusting Parallel Grip Pliers with Swivel Pads



**2950**



235 mm



1 2950-250

### Grip Locking Clamps with C-Clamp



**2963**



283 mm  
458 mm  
580 mm



1 2963-280  
1 2963-450  
1 2963-630

### Steel Clamp, Swivel Pads, Slim



**2956**



282 mm



1 2956-290

### Self Adjusting Grip Locking Clamps with Parallel C-Clamp



**2964**



175 mm  
280 mm  
436 mm  
625 mm



1 2964-160  
1 2964-280  
1 2964-450  
1 2964-600

### Stepped C Clamps



**2962**



290 mm  
290 mm  
290 mm



1 2962-8-150  
1 2962-8-230  
1 2962-8-300



### Special Grip and Locking U-Clamps



#### 2965



228 mm  
290 mm



1 2965-200  
1 2965-280

### Special Grips for Tubes and Pipes



#### 2966



290 mm



1 2966-280

### Locking Pliers Spare Parts



#### 2951-S



|       |      |   |          |
|-------|------|---|----------|
| 43 mm | 15 g | 1 | 2951-S05 |
| 46 mm | 25 g | 1 | 2951-S07 |
| 62 mm | 50 g | 1 | 2951-S10 |
| 87 mm | 70 g | 1 | 2951-S12 |

### Universal Grip Pliers with 4 Positions Long Jaws



#### 2997



255 mm

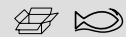

5 2997-300

### Universal Grip Pliers with 4 Positions Short Jaws



#### 2997-250



235 mm



1 2997-250

### Automatic Hand Vices with Phosphate Finish



#### 2949



193 mm  
196 mm  
240 mm  
240 mm



1 2949-190IP  
1 2949-200IP  
1 2949-240IP  
1 2949-250IP

Hand Vices Spare Bolt



**2949-L**

|                        |        |   |           |
|------------------------|--------|---|-----------|
|                        |        |   |           |
| 2949-190IP             | 75 mm  | 1 | 2949-L075 |
| 2949-200IP, 2949-240IP | 120 mm | 1 | 2949-L120 |
| 2949-250IP             | 200 mm | 1 | 2949-L200 |

Notching pliers.



**2690**

|        |    |      |
|--------|----|------|
|        |    |      |
| 200 mm | 10 | 2690 |

**RIVETING TOOLS**

Hand Riveters with 360° Swivel Head



**2681**

|        |    |      |
|--------|----|------|
|        |    |      |
| 285 mm | 12 | 2681 |

Long Arm Riveters with Transparent Tube Collects



**1467-520**

|        |   |          |
|--------|---|----------|
|        |   |          |
| 530 mm | 1 | 1467-520 |

Hand Riveters with Exchangeable Heads



**1467-250**

|        |   |          |
|--------|---|----------|
|        |   |          |
| 255 mm | 1 | 1467-250 |

Extensible Riveters for Cu/Al and Stainless Steel



**1467-320-850**

|        |   |              |
|--------|---|--------------|
|        |   |              |
| 850 mm | 1 | 1467-320-850 |



Spare Parts for 1467 Series Riveter



**1467**



10 g  
10 g



1 1467-LJ  
1 1467-SJ

Spare Part Set for 2681 Series Riveter - 4 Pcs



**2681-1**



15 g



1 2681-1

**SPECIAL PLIERS**

Automatic Wire Tie Tensioning Tools for Electric Nylon Ties



**790450A**



<2.2x5 mm



1 790450A

Wire Tie Tensioning Tools for Electric Nylon Ties



**790455A**



<9.5x2.3 mm



1 790455A

Wire Twisting Pliers with Phosphate Finish



**2855**



236 mm  
287 mm

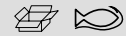

1 2855  
1 2855 D

Wire Twisting Pliers, One-hand Operation



**2856**



203 mm  
268 mm



1 2856-8  
1 2856-10



## Pipe Wrenches & Tubing Tools





## PIPE WRENCHES

### ERGO™ Quick-Adjust Pipe Wrenches



#### 1610/1620

| L      | max      |   |      |
|--------|----------|---|------|
| 320 mm | 1 in     | 1 | 1610 |
| 430 mm | 1 1/2 in | 1 | 1620 |

10 times faster vs standard model

### ERGO™ Swedish Model 90° Pipe Wrenches



#### 1410/1420

| L      | max      |   |      |
|--------|----------|---|------|
| 320 mm | 1 in     | 1 | 1410 |
| 430 mm | 1 1/2 in | 1 | 1420 |

### ERGO™ Swedish Model 90° Pipe Wrenches with Soft-Touch Shank



#### 1410D/1420D

| L      | max      |   |       |
|--------|----------|---|-------|
| 320 mm | 1 in     | 1 | 1410D |
| 430 mm | 1 1/2 in | 1 | 1420D |

### Swedish Model 90° Pipe Wrenches



#### 140-147

| L       | max      |   |     |
|---------|----------|---|-----|
| 210 mm  | 3/4 in   | 1 | 140 |
| 320 mm  | 1 in     | 1 | 141 |
| 426 mm  | 1 1/2 in | 1 | 142 |
| 557 mm  | 2 1/2 in | 1 | 143 |
| 722 mm  | 3 1/2 in | 1 | 144 |
| 1060 mm | 5 in     | 1 | 147 |

### Spare Nuts for Quick-Adjust Pipe Wrenches



#### 1610-nut/1620-nut

| Ø       | g    |   |          |
|---------|------|---|----------|
| 11 mm   | 34 g | 1 | 1610-NUT |
| 11.5 mm | 48 g | 1 | 1620-NUT |

### Swedish Model 90° Pipe Wrench with Green Powder Coat



#### DOW175

| L      | max      |   |              |
|--------|----------|---|--------------|
| 310 mm | 1 in     | 1 | DOW 175-1    |
| 420 mm | 1 1/2 in | 1 | DOW 175-11/2 |
| 560 mm | 2 in     | 1 | DOW 175-2    |
| 630 mm | 3 in     | 1 | DOW 175-3    |

### Corner Pipe Wrench



#### 442 B-444 B

| L      | max      |   |       |
|--------|----------|---|-------|
| 320 mm | 1 in     | 1 | 442 B |
| 430 mm | 2 in     | 1 | 443 B |
| 545 mm | 2 1/2 in | 1 | 444 B |

### Swedish Model Corner Combination Pipe Wrench



#### 341-344

| L      | max      |   |     |
|--------|----------|---|-----|
| 230 mm | 1/2 in   | 1 | 341 |
| 330 mm | 1 in     | 1 | 342 |
| 420 mm | 1 1/2 in | 1 | 343 |
| 530 mm | 2 in     | 1 | 344 |

### Swedish Model Corner Combination Pipe Wrench with Green Powder Coat



#### DOW177

| L      | max      |   |               |
|--------|----------|---|---------------|
| 325 mm | 1 in     | 1 | DOW 177-1/2-1 |
| 425 mm | 1 1/2 in | 1 | DOW 177-11/2  |
| 534 mm | 2 in     | 1 | DOW 177-2     |

Swedish Model 45° Corner Pipe Wrench with Green Powder



**DOW176**

| L      | max      |   |              |
|--------|----------|---|--------------|
| 330 mm | 1 in     | 1 | DOW 176-1    |
| 415 mm | 1 1/2 in | 1 | DOW 176-11/2 |
| 530 mm | 2 in     | 1 | DOW 176-2    |

Spare Fixed Jaw for Aluminium Pipe Wrenches



**8100F**

|        | g     |   |           |
|--------|-------|---|-----------|
| 380-18 | 90 g  | 1 | 8100F0180 |
| 380-24 | 180 g | 1 | 8100F0240 |

Mobil Jaws for Stillson Wrench



**8060B**

|        | g      |   |           |
|--------|--------|---|-----------|
| 361-8  | 80 g   | 1 | 8060B0080 |
| 361-10 | 200 g  | 1 | 8060B0100 |
| 361-12 | 270 g  | 1 | 8060B0120 |
| 361-14 | 330 g  | 1 | 8060B0140 |
| 361-18 | 520 g  | 1 | 8060B0180 |
| 361-24 | 970 g  | 1 | 8060B0240 |
| 361-36 | 1630 g | 1 | 8060B0360 |

Multipurpose Aluminium Pipe Wrenches



**380**

| L       | max      |   |        |
|---------|----------|---|--------|
| 253 mm  | 1.1/2 in | 1 | 380-10 |
| 320 mm  | 2 in     | 1 | 380-14 |
| 455 mm  | 2.1/2 in | 1 | 380-18 |
| 607 mm  | 3 in     | 1 | 380-24 |
| 910 mm  | 4 in     | 1 | 380-36 |
| 1210 mm | 6 in     | 1 | 380-48 |

Spare Nuts for Aluminium Pipe Wrench



**8100T**

|        | g     |   |           |
|--------|-------|---|-----------|
| 380-10 | 30 g  | 1 | 8100T0100 |
| 380-14 | 45 g  | 1 | 8100T0140 |
| 380-18 | 70 g  | 1 | 8100T0180 |
| 380-24 | 110 g | 1 | 8100T0240 |
| 380-36 | 220 g | 1 | 8100T0360 |
| 380-48 | 310 g | 1 | 8100T0480 |

Spare Nut for Stillson Wrench



**8060T**

|        | g     |   |           |
|--------|-------|---|-----------|
| 361-8  | 20 g  | 1 | 8060T0080 |
| 361-10 | 20 g  | 1 | 8060T0100 |
| 361-14 | 40 g  | 1 | 8060T0140 |
| 361-18 | 70 g  | 1 | 8060T0180 |
| 361-24 | 90 g  | 1 | 8060T0240 |
| 361-36 | 250 g | 1 | 8060T0360 |

Spare Mobil Jaws for Aluminium Pipe Wrenches



**8100B**

|        | g      |   |           |
|--------|--------|---|-----------|
| 380-14 | 430 g  | 1 | 8100B0140 |
| 380-18 | 680 g  | 1 | 8100B0180 |
| 380-24 | 1000 g | 1 | 8100B0240 |
| 380-36 | 1810 g | 1 | 8100B0360 |

Stillson Pipe Wrenches



**361**

| L      | max      |   |        |
|--------|----------|---|--------|
| 185 mm | 1 in     | 1 | 361-8  |
| 230 mm | 1.1/2 in | 1 | 361-10 |
| 265 mm | 1.3/4 in | 1 | 361-12 |
| 315 mm | 2 in     | 1 | 361-14 |
| 450 mm | 2.1/2 in | 1 | 361-18 |
| 535 mm | 3 in     | 1 | 361-24 |
| 900 mm | 4 in     | 4 | 361-36 |

Heavy Duty Chain Pipe Wrenches



**372**

| L      |  |   |           |
|--------|--|---|-----------|
| 1.1 in |  | 1 | 372-1.1/2 |
| 2.1 in |  | 1 | 372-2.1/2 |
| 4 in   |  | 1 | 372-4     |
| 6 in   |  | 1 | 372-6     |
| 8 in   |  | 1 | 372-8     |
| 12 in  |  | 1 | 372-12    |



Spare Chains For Special Pipe Wrenches



**3074**

| L       | Icon      | Icon | Icon    |
|---------|-----------|------|---------|
| 340 mm  | 372-1.1/2 | 1    | 307401B |
| 475 mm  | 372-2.1/2 | 1    | 307411B |
| 560 mm  | 372-4     | 1    | 307421B |
| 830 mm  | 372-6     | 1    | 307431B |
| 1000 mm | 372-8     | 1    | 307441  |
| 1400 mm | 372-12    | 1    | 307451  |

Telescopic Basin Wrenches with 4 Positionings



**363**

| L      | Icon | Icon | Icon   |
|--------|------|------|--------|
| 280 mm |      | 1    | 363-32 |

Pipe Cutters 3 mm-35 mm



**402-35**

| Icon    | Icon | Icon     |
|---------|------|----------|
| 3-35 mm |      | 6 402-35 |

Chain Pipe Wrenches with Steel Handle



**370**

| L      | Icon | Icon | Icon  |
|--------|------|------|-------|
| 300 mm |      | 1    | 370-4 |

Pipe Cutters



**401-16**

| Icon    | Icon | Icon | Icon   |
|---------|------|------|--------|
| 3-16 mm |      | 12   | 401-16 |

Pipe Cutters with Quick Adjust System



**402-76**

| Icon     | Icon | Icon | Icon   |
|----------|------|------|--------|
| 12-76 mm |      | 6    | 402-76 |

Special Pipe Wrenches with Nylon Strap and Steel Handle



**375**

| L      | Icon | Icon | Icon  |
|--------|------|------|-------|
| 300 mm |      | 50   | 375-8 |

Pipe Cutters 3 mm-28 mm



**401-28**

| Icon    | Icon | Icon | Icon   |
|---------|------|------|--------|
| 3-28 mm |      | 12   | 401-28 |

Automatic Tube Cutter 10-22 mm



**306-**

| Icon  | Icon | Icon | Icon   |
|-------|------|------|--------|
| 10 mm |      | 1    | 306-10 |
| 12 mm |      | 1    | 306-12 |
| 15 mm |      | 12   | 306-15 |
| 22 mm |      | 12   | 306-22 |

Compact Tube Cutter 3-16 mm



**301-16**

|         |       |    |        |
|---------|-------|----|--------|
|         |       |    |        |
| 3-16 mm | 72 mm | 12 | 301-16 |

Tube Cutter 35-75 mm



**302-76**

|  |   |           |
|--|---|-----------|
|  |   |           |
|  | 1 | 302-76-95 |

Spare Wheels Set and Pin for 301/302 Pipe Cutters



**302-95-SET**

|      |   |            |
|------|---|------------|
|      |   |            |
| 30 g | 1 | 302-95-SET |

Compact Tube Cutter 3-22 mm



**301-22**

|         |    |        |
|---------|----|--------|
|         |    |        |
| 3-28 mm | 12 | 301-22 |

Tube Cutter with Quick Adjust System 12-76 mm



**302-76N**

|          |        |   |         |
|----------|--------|---|---------|
|          |        |   |         |
| 12-76 mm | 318 mm | 6 | 302-76N |

Spare Cutting Wheels for 306 Series Tube Cutters



**306-15-95**

|      |   |           |
|------|---|-----------|
|      |   |           |
| 10 g | 1 | 306-15-95 |

Tube Cutter 8-35 mm



**302-35**

|         |   |        |
|---------|---|--------|
|         |   |        |
| 3-35 mm | 6 | 302-35 |

Spare Cutting Wheels for 301/302 & 401/402 Series Tube Cutters



**302/402-15-95**

|                              |     |     |           |
|------------------------------|-----|-----|-----------|
|                              |     |     |           |
| 301-16,301-22,302-35,302-75N | 5 g | 100 | 302-15-95 |
| 401-16,401-28,402-35,402-75  | 5 g | 1   | 402-15-95 |

Spare Wheels and Pins for 401/402 Pipe Cutters



**402-95-SET**

|      |   |            |
|------|---|------------|
|      |   |            |
| 30 g | 1 | 402-95-SET |



Plastic Tube Cutter



**311-32**

|       |   |        |
|-------|---|--------|
|       |   |        |
| 32 mm | 6 | 311-32 |

Plastic Pipe Scissors for Multilayer



**412-26-MULTI**

|       |   |              |
|-------|---|--------------|
|       |   |              |
| 26 mm | 5 | 412-26-MULTI |

Spare Blades for 412-26-MULTI Plastic Pipe Cutters



**412-26-MULTI-95**

|   |      |     |                 |
|---|------|-----|-----------------|
|   |      |     |                 |
| 1 | 10 g | 150 | 412-26-MULTI-95 |

Plastic Pipe Scissors



**411**

|       |   |        |
|-------|---|--------|
|       |   |        |
| 26 mm | 4 | 411-26 |
| 35 mm | 4 | 411-35 |
| 42 mm | 6 | 411-42 |
| 63 mm | 5 | 411-63 |

Spare Blades for Plastic Pipe Scissors



**411-95**

|   |      |    |           |
|---|------|----|-----------|
|   |      |    |           |
| 1 | 39 g | 50 | 411-26-95 |
| 1 | 37 g | 50 | 411-35-95 |
| 1 | 41 g | 50 | 411-42-95 |
| 1 | 48 g | 30 | 411-63-95 |

## BENDING & FORMING TOOLS

Multipurpose Tube Bender



**1084**

|        |           |   |      |
|--------|-----------|---|------|
|        |           |   |      |
| 250 mm | 6,8 10 mm | 5 | 1084 |

Plastic Pipe Scissors for PEX



**412-28-PEX**

|       |   |            |
|-------|---|------------|
|       |   |            |
| 28 mm | 5 | 412-28-PEX |

Spare Blades for 412-28-PEX Pipe Scissors



**412-28-PEX-95**

|   |      |    |               |
|---|------|----|---------------|
|   |      |    |               |
| 1 | 35 g | 30 | 412-28-PEX-95 |

Tube Bender



**500**

|       |   |        |
|-------|---|--------|
|       |   |        |
| 12 mm | 1 | 500-12 |
| 14 mm | 1 | 500-14 |
| 15 mm | 1 | 500-15 |
| 16 mm | 1 | 500-16 |
| 18 mm | 1 | 500-18 |
| 22 mm | 1 | 500-22 |



Tube Flaring Tool In Metric Sizes



**4480MM**

|     |                                |   |        |
|-----|--------------------------------|---|--------|
|     |                                |   |        |
| 45° | 4, 6, 8, 10, 12, 14, 16, 18 mm | 1 | 4480MM |

Imperial Tube Flaring Tool



**4480IM**

|     |  |   |        |
|-----|--|---|--------|
|     |  |   |        |
| 45° | 5/8, 3/16, 1/4, 5/16, 3/8, 7/16, 1/2, 3/4 in | 1 | 4480IM |

Tube Cutter and Double Flaring Tool Set



**4480/**

|                   |   |           |
|-------------------|---|-----------|
|                   |   |           |
| 45 x 140 x 330 mm | 1 | 4480/2-ZD |

**DEBURRING TOOLS**

Aluminium Pen Reamer



**316-1**

|        |    |       |
|--------|----|-------|
|        |    |       |
| 143 mm | 12 | 316-1 |

Plastic Pen Reamer



**316-2**

|        |    |       |
|--------|----|-------|
|        |    |       |
| 150 mm | 12 | 316-2 |

Spare Blade for 316-2 Pen Reamer



**316-2-95**

|     |   |          |
|-----|---|----------|
|     |   |          |
| 3 g | 1 | 316-2-95 |

Aluminium Wheel Reamer



**318-38/318-54**

|                     |        |                  |
|---------------------|--------|------------------|
|                     |        |                  |
| 8-38 mm<br>10-54 mm | 1<br>1 | 318-38<br>318-54 |

Plastic Wheel Reamer



**317-40**

|         |    |        |
|---------|----|--------|
|         |    |        |
| 3-40 mm | 12 | 317-40 |





**BAHCO**



## Air Tools



## IMPACT WRENCHES

3/8" Square Drive Mini Impact Wrenches



**BP704**

**BAR**



6.3 bar 1500 min 1 BP704

3/8" Square Drive Lightweight Impact Wrenches with Twin Hammer Mechanism



**BPC816**

**BAR**

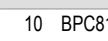

12.000 min 6,3 bar 10 BPC816

1/2" Square Drive Angle Impact Wrenches with Jumbo Hammer Mechanism



**BP814A**

**BAR**

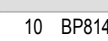

7000 min 6.2 bar 10 BP814A

1/2" Impact Wrenches with Twin Hammer Mechanism 360 N.m



**BP814**

**BAR**

10,000 min 6.3 bar



10 BP814

1/2" Impact Wrenches with Twin Hammer Mechanism 620 N.m



**BP815**

**BAR**

7,000 min 6.3 bar



1 BP815

1/2" Impact Wrench Kit - 13 Pcs



**BP815K1**

**BAR**

7,000 min 6.3 bar



1 BP815K1

**BP815**

K7800M-10, K7800M-11, K7800M-12, K7800M-13, K7800M-14, K7800M-15, K7800M-17, K7800M-19, K7800M-22, K7800M-24, K7800M-21

**PM5142**

1/2" Impact Wrench Kit - 3 Pcs



**BP815K2**

**BAR**

7,000 min 6.3 bar



1 BP815K2

1/2" Square Drive Micro Impact Wrenches with Twin Hammer Mechanism



**BPC813**

**BAR**

10000 min 6,3 bar



10 BPC813

1/2" Square Drive Micro Impact Wrench Set with Ultra Short Sockets



**BPC813K1**

**BAR**

1/2 in 65 x 162 x 215 mm



1 BPC813K1

**BPC813**

K7800M-13, K7800M-14, K7800M-16, K7800M-17, K7800M-19, K7800M-21, K7800M-22, K7800M-24

1/2" Composite Impact Wrenches with Twin Hammer Mechanism 338 N.m



**BPC814**



**BAR**



12000 min 6,3 bar 10 BPC814

1/2" Composite Impact Wrenches with Twin Hammer Mechanism 786 N.m



**BPC815**



**BAR**



8000 min 6,3 bar 1 BPC815

1/2" Square Drive Impact Wrench Set with 11 Metric Sockets



**BPC815K1**



1/2 in 90 x 230 x 390 mm 1 BPC815K1

**BPC815**

K7801M-10, K7801M-11, K7801M-12, K7801M-13, K7801M-14, K7801M-15, K7801M-17, K7801M-19, K7801M-21, K7801M-22, K7801M-24



1/2" Square Drive Impact Wrench Set with 5 Metric Sockets



**BPC815K2**



1/2 in 90 x 230 x 320 mm 1 BPC815K2

**BPC815**

K7801M-19, K7801M-22, K7801M-24, K7801M-17, K7801M-13



1/2" Square Drive Impact Wrench Set with 5 Imperial Sockets



**BPC815K3**



1/2 in 90 x 230 x 320 mm 1 BPC815K3

**BPC815**

K7801Z-1/2, K7801Z-5/8, K7801Z-3/4, K7801Z-7/8, K7801Z-15/16



**BPC815**



**BWSS12P5**



1/2" Square Drive Impact Wrench Set with 2 Wheel Metric Sockets



**BPC815K6**



1/2 in 90 x 230 x 320 mm 1 BPC815K6

**BPC815**



**BWSS12P319, BWSS12P317**



3/4" Impact Wrenches with Twin Hammer Mechanism 950 N.m



**BP817**



**BAR**



4,500 min 6,3 bar 1 BP817

3/4" Square Drive Lightweight Impact Wrenches with Twin Hammer Mechanism



**BPC817**



**BAR**



5000 min 6,2 bar 4 BPC817

**BPC815K4**



1/2 in 90 x 230 x 320 mm 1 BPC815K4





3/4" Square Drive Impact Wrench Set with 4 Metric Sockets



**BPC817K1**

3/4 in 105 x 295 x 390 mm 1 BPC817K1

BPC817

K8901M-24, K8901M-27, K8901M-32, K8901M-30



3/4" Square Drive Impact Wrench Set with 4 Imperial Sockets



**BPC817K2**

3/4 in 105 x 295 x 390 mm 1 BPC817K2

BPC817

K8901Z-15/16, K8901Z-1, K8901Z-1.1/16, K8901Z-1.1/8



1" Square Drive Lightweight Impact Wrenches with Durable Rocking Dog Mechanism



**BP901**

3800 min **BAR** 6.2 bar 1 BP901

1" Square Drive Lightweight Impact Wrenches with Durable Rocking Dog Mechanism and 9" Anvil



**BP901L**

3800 min **BAR** 6.2 bar 1 BP901L

1" Square Drive Lightweight Impact Wrenches with Twin Hammer Mechanism and Long Anvil



**BP905L**

6000 min **BAR** 6.2 bar 2 BP905L

1" Square Drive Lightweight Impact Wrenches with Twin Hammer Clutch Mechanism



**BP905P**

6000 min **BAR** 6.2 bar 2 BP905P

Impact Wrench Boots with Rubber Protection



**BPM91B**

85 x 80 x 180 mm 162 g 1 BPM91BOOT

1" Square Drive Lightweight Impact Wrenches with Twin Hammer Mechanism and Short Anvil



**BP905S**

6000 min **BAR** 6.2 bar 2 BP905S

Impact Wrench Silencer Kit



**BPM91MK**

30 x 25 x 25 mm 5 g 1 BPM91MK1  
30 x 25 x 50 mm 10 g 1 BPM91MK2

## RATCHETS

1/4" Mini Air Ratchets with Power Regulator



**BP700**

|         |            |    |       |
|---------|------------|----|-------|
|         | <b>BAR</b> |    |       |
| 300 min | 6.3 bar    | 20 | BP700 |

1/2" Ratchets with Rubber Grip



**BP821**

|         |            |   |       |
|---------|------------|---|-------|
|         | <b>BAR</b> |   |       |
| 150 min | 6.3 bar    | 1 | BP821 |

## GRINDERS, SANDERS & POLISHERS

Angle Die Grinders with Rubber Grip



**BP115**

|            |            |   |       |
|------------|------------|---|-------|
|            | <b>BAR</b> |   |       |
| 20,000 min | 6.3 bar    | 1 | BP115 |

3/8" Square Drive Stubby Air Ratchets



**BP721**

|         |            |   |       |
|---------|------------|---|-------|
|         | <b>BAR</b> |   |       |
| 350 min | 6.3 bar    | 1 | BP721 |

1/2" Square Drive Reactionless Impact Ratchet



**BPR821**

|         |            |   |        |
|---------|------------|---|--------|
|         | <b>BAR</b> |   |        |
| 600 min | 6.3 bar    | 1 | BPR821 |

Low Revolution Air Grinder/Tyre Buffers with Hex Quick Change Chuck



**BP117**

|          |            |   |       |
|----------|------------|---|-------|
|          | <b>BAR</b> |   |       |
| 2500 min | 6.3 bar    | 1 | BP117 |

3/8" Air Ratchets with Power Regulator



**BP820**

|         |            |   |       |
|---------|------------|---|-------|
|         | <b>BAR</b> |   |       |
| 270 min | 6.3 bar    | 1 | BP820 |

Air Ratchet Boots for 1/4" Ratchets



**BP91B**

|                 |      |   |        |
|-----------------|------|---|--------|
|                 |      |   |        |
| 35 x 40 x 60 mm | 12 g | 1 | BP91BL |
| 30 x 30 x 45 mm | 6 g  | 1 | BP91BS |

Low Speed Air Grinder/Tyre Buffers with Keyed Chuck



**BP118**

|          |            |   |       |
|----------|------------|---|-------|
|          | <b>BAR</b> |   |       |
| 2500 min | 6.3 bar    | 1 | BP118 |



Die Grinders with Rubber Grip



**BP822**

|            |            |   |       |
|------------|------------|---|-------|
|            | <b>BAR</b> |   |       |
| 25,000 min | 6.3 bar    | 1 | BP822 |

Coarse Grinding Bullet Abrasive Wheels with 6 mm Shank - 2 Pcs/Blister Pack



**BP421M**

|       |       |   |        |
|-------|-------|---|--------|
|       |       |   |        |
| 53 mm | 14 mm | 1 | BP421M |

Coarse Grinding 90° Cone Abrasive Wheels with 6 mm Shank - 2 Pcs/Blister Pack



**BP424M**

|       |       |   |        |
|-------|-------|---|--------|
|       |       |   |        |
| 57 mm | 19 mm | 1 | BP424M |

Air Die Grinders with 6 mm Shank, Long Anvil and Rubber Grip



**BP822E**

|           |            |    |        |
|-----------|------------|----|--------|
|           | <b>BAR</b> |    |        |
| 25000 min | 6.3 bar    | 10 | BP822E |

Coarse Grinding Cylindrical Abrasive Wheels with 6 mm Shank - 2 Pcs/Blister Pack



**BP422M**

|       |       |   |        |
|-------|-------|---|--------|
|       |       |   |        |
| 46 mm | 26 mm | 1 | BP422M |

Fine Grinding Conical Round Nose Abrasive Wheels with 3 mm Shank - 2 Pcs/Blister Pack



**BP430M**

|       |       |   |        |
|-------|-------|---|--------|
|       |       |   |        |
| 55 mm | 12 mm | 1 | BP430M |

Coarse Grinding Conical Round Nose Abrasive Wheels with 6 mm Shank - 2 Pcs/Blister Pack



**BP420M**

|       |       |   |        |
|-------|-------|---|--------|
|       |       |   |        |
| 67 mm | 25 mm | 1 | BP420M |

Coarse Grinding Spherical Abrasive Wheels with 6 mm Shank - 2 Pcs/Blister Pack



**BP423M**

|       |       |   |        |
|-------|-------|---|--------|
|       |       |   |        |
| 53 mm | 25 mm | 1 | BP423M |

Fine Grinding Small Bullet Abrasive Wheels with 3 mm Shank - 2 Pcs/Blister Pack



**BP431M**

|       |       |   |        |
|-------|-------|---|--------|
|       |       |   |        |
| 54 mm | 13 mm | 1 | BP431M |

**BAHCO**

Fine Grinding Small 90° Cone Abrasive Wheels with 3 mm Shank - 2 Pcs/Blister Pack



**BP432M**

|       |       |   |        |
|-------|-------|---|--------|
|       |       |   |        |
| 44 mm | 15 mm | 1 | BP432M |

Reversible Cut-Off Tools



**BP110**

|            |            |   |       |
|------------|------------|---|-------|
|            | <b>BAR</b> |   |       |
| 18,000 min | 6.3 bar    | 1 | BP110 |

Exhaust Hoses for BP117 Low Revolution Grinder/Tyre Buffers



**BP117EH**

|                  |      |   |         |
|------------------|------|---|---------|
|                  |      |   |         |
| 50 x 100 x 50 mm | 1 kg | 1 | BP117EH |

Fine Grinding Small Tapered Ball Abrasive Wheels with 3 mm Shank - 2 Pcs/Blister Pack



**BP433M**

|       |       |   |        |
|-------|-------|---|--------|
|       |       |   |        |
| 43 mm | 14 mm | 1 | BP433M |

Disc Grinders with Rubber Grip and Safety Trigger



**BP823**

|            |            |   |       |
|------------|------------|---|-------|
|            | <b>BAR</b> |   |       |
| 10,000 min | 6.3 bar    | 1 | BP823 |

Surface Cleaners with 19 Needles



**BP127**

|          |            |   |       |
|----------|------------|---|-------|
|          | <b>BAR</b> |   |       |
| 3700 min | 6.3 bar    | 1 | BP127 |

Fine Grinding Small Cylindrical Abrasive Wheels with 3 mm Shank - 2 Pcs/Blister Pack



**BP434M**

|       |       |   |        |
|-------|-------|---|--------|
|       |       |   |        |
| 45 mm | 13 mm | 1 | BP434M |

4"/102 mm Extended Air Cut-Off Tools



**BP111E**

|           |            |    |        |
|-----------|------------|----|--------|
|           | <b>BAR</b> |    |        |
| 15000 min | 6.3 bar    | 12 | BP111E |

Pistol Grip Surface Cleaners with 19 Needles



**BP127P**

|          |            |   |        |
|----------|------------|---|--------|
|          | <b>BAR</b> |   |        |
| 3800 min | 6.3 bar    | 1 | BP127P |





Needle Set



**BP12718**



BP127, BP127P 3 mm 1 BP12718

Rubber Dish Solvent Based



**BP830ESB**



30 mm 105 mm 1 BP830ESB

Straight Bristles Adaptor



**BP830SBA**

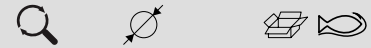

BP830K 105 mm 1 BP830SBA

Coarse Inclined Steel Bristles



**BP830CISB**



BP830K 105 mm 1 BP830CISB

Rubber Eraser, Water Based



**BP830EWB**



BP830K 105 mm 1 BP830EWB

Straight Steel Bristles



**BP830SSB**



BP830K 105 mm 1 BP830SSB

Air Blaster Kit



**BP830K**



4000 min<sup>-1</sup> 6.3 bar 4 BP830K

Straight Steel Bristles

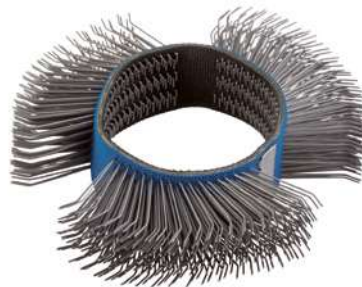

**BP830MISB**



BP830K 105 mm 1 BP830MISB

Stripping Wheel



**BP830SW**

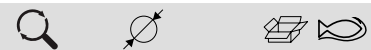

BP830K 105 mm 1 BP830SW



Pistol-Grip Air Sander Set - 71 Pcs



**BP204K**

|           |            |   |        |
|-----------|------------|---|--------|
|           | <b>BAR</b> |   |        |
| 15000 min | 6.3 bar    | 1 | BP204K |

BP20425180, BP20410800, BP20410320, BP20425220

BP204

Sanding Pads for BP204 Pistol-Grip Sander



**BP204PAD**

|       |   |   |          |
|-------|---|---|----------|
|       |   |   |          |
| 77 mm | - | 1 | BP204PAD |

Belt Sanders with Quick Belt Release Button



**BP212**

|            |            |   |       |
|------------|------------|---|-------|
|            | <b>BAR</b> |   |       |
| 16,000 min | 6.3 bar    | 1 | BP212 |

Orbital Sander Pads with Velcro Pad



**BP51137**

|        |   |   |         |
|--------|---|---|---------|
|        |   |   |         |
| 152 mm | x | 1 | BP51137 |

5 mm Palm Orbital Sanders with Velcro Pad



**BP601**

|        |            |   |       |
|--------|------------|---|-------|
|        | <b>BAR</b> |   |       |
| 152 mm | 6.3 bar    | 1 | BP601 |

Velcro Pad 53 Holes



**BP60102**

|       |        |   |         |
|-------|--------|---|---------|
|       |        |   |         |
| BP601 | 152 mm | 1 | BP60102 |

3" Pistol Grip Orbital Air Sanders with Rubber Grip



**BP204**

|           |            |   |       |
|-----------|------------|---|-------|
|           | <b>BAR</b> |   |       |
| 15000 min | 6.3 bar    | 1 | BP204 |

Sanding Discs for 3" Wheel Sanders



**BP204xyyy**

|       |  |   |            |
|-------|--|---|------------|
|       |  |   |            |
| 77 mm |  | 1 | BP20410320 |
| 77 mm |  | 1 | BP20410800 |
| 77 mm |  | 1 | BP20425180 |
| 77 mm |  | 1 | BP20425220 |

20 mm Belt Sanders with Quick Belt Release Button



**BP222**

|            |            |   |       |
|------------|------------|---|-------|
|            | <b>BAR</b> |   |       |
| 16,000 min | 6.3 bar    | 1 | BP222 |



2.5 mm Palm Orbital Sanders with Velcro Pad



**BP610**

|        |            |   |       |
|--------|------------|---|-------|
|        | <b>BAR</b> |   |       |
| 152 mm | 6.3 bar    | 1 | BP610 |

7" Vertical Air Polishers with Rubber Grip



**BP810**

|          |            |   |       |
|----------|------------|---|-------|
|          | <b>BAR</b> |   |       |
| 2500 min | 6.3 bar    | 1 | BP810 |

1/2" Reversible Air Drills 800 rpm



**BPC825**

|         |            |   |        |
|---------|------------|---|--------|
|         | <b>BAR</b> |   |        |
| 800 min | 6.3 bar    | 1 | BPC825 |

Pack of 25 Belts for Belt Sanders



**BPN22201/21201**

|       |   |          |
|-------|---|----------|
|       |   |          |
| 10 mm | 1 | BPN21201 |
| 20 mm | 1 | BPN22201 |

7" Wool Bonnets



**BP80950**

|        |      |   |         |
|--------|------|---|---------|
|        |      |   |         |
| 178 mm | 15 g | 1 | BP80950 |

3/8" Compact Reversible Air Drills 2,000 rpm



**BPC823**

|          |            |   |        |
|----------|------------|---|--------|
|          | <b>BAR</b> |   |        |
| 2000 min | 6.3 bar    | 1 | BPC823 |

**DRILLS & SCREWDRIVERS**

7" Air Angle Polishers with Rubber Grip and Spindle Lock



**BP809**

|          |            |   |       |
|----------|------------|---|-------|
|          | <b>BAR</b> |   |       |
| 2500 min | 6.3 bar    | 1 | BP809 |

1/2" Reversible Drills with Rubber Grip 13 mm



**BP825**

|         |            |   |       |
|---------|------------|---|-------|
|         | <b>BAR</b> |   |       |
| 450 min | 6.3 bar    | 1 | BP825 |

3/8" Compact Angle Air Drills 1,400 rpm



**BPA823**

|          |            |   |        |
|----------|------------|---|--------|
|          | <b>BAR</b> |   |        |
| 1400 min | 6.3 bar    | 1 | BPA823 |

1/4" Air Screwdrivers 1800 rpm



**BP826**

|          |            |   |       |
|----------|------------|---|-------|
|          | <b>BAR</b> |   |       |
| 1800 min | 6.3 bar    | 1 | BP826 |

Reciprocating Saws with Safety Trigger



**BP824**

|            |            |   |       |
|------------|------------|---|-------|
|            | <b>BAR</b> |   |       |
| 10,000 min | 6.3 bar    | 1 | BP824 |

Flat and Jagged Straight Blades



**BPBG**

|       |   |           |
|-------|---|-----------|
|       |   |           |
| 15 mm | 1 | BPBG3515  |
| 25 mm | 1 | BPBG3525A |
| 25 mm | 1 | BPBG3525B |

1/4" Air Screwdrivers 800 rpm



**BP827**

|         |            |   |       |
|---------|------------|---|-------|
|         | <b>BAR</b> |   |       |
| 800 min | 6.3 bar    | 1 | BP827 |

Geared Reciprocating Saws with Safety Trigger



**BPG824**

|          |            |    |        |
|----------|------------|----|--------|
|          | <b>BAR</b> |    |        |
| 7400 min | 6.3 bar    | 10 | BPG824 |

Offset Comma Shaped Blades - 2 Pcs/ Blister Pack



**BPBK**

|       |   |        |
|-------|---|--------|
|       |   |        |
| 30 mm | 1 | BPBK30 |

**CUTTING TOOLS**

Compact Reciprocating Saws with Safety Trigger



**BP828**

|           |            |   |       |
|-----------|------------|---|-------|
|           | <b>BAR</b> |   |       |
| 10000 min | 6.3 bar    | 1 | BP828 |

Windscreen Removers with Low Vibration



**BP233**

|    |            |   |       |
|----|------------|---|-------|
|    | <b>BAR</b> |   |       |
| 20 | 6.3 bar    | 1 | BP233 |

Scrapers - 2 Pcs/Blister Pack



**BPBSC**

|       |   |          |
|-------|---|----------|
|       |   |          |
| 15 mm | 1 | BPBSC156 |



U Shaped Blades - 2 Pcs/Blister Pack



**BPBU**

| L     |          |
|-------|----------|
| 18 mm | 1 BPBU18 |
| 24 mm | 1 BPBU24 |
| 36 mm | 1 BPBU36 |
| 60 mm | 1 BPBU60 |
| 90 mm | 1 BPBU90 |

Air Metal Shears with Rubber Grip and Safety Trigger



**BP811**

| min <sup>-1</sup> | BAR     |         |
|-------------------|---------|---------|
| 2,600 min         | 6.3 bar | 1 BP811 |

Straight Offset Blades - 2 Pcs/Blister Pack



**BPBG5725/9057**

| L     |            |
|-------|------------|
| 57 mm | 1 BPBG5725 |
| 90 mm | 1 BPBG9057 |

**HAMMERS, RIVETERS & MARKERS**

Air Hammers 3200 bpm



**BP910**

| BAR     | (min <sup>-1</sup> ) |         |
|---------|----------------------|---------|
| 6.3 bar | 3200                 | 5 BP910 |

Rotating Flat Chisels with 10.2 mm Shank



**BP909TF**

| L      |           |
|--------|-----------|
| 170 mm | 1 BP909TF |

Rotating Wide Flat Chisels with 10.2 mm Shank



**BP909TWF**

| L      |            |
|--------|------------|
| 170 mm | 1 BP909TWF |

Rotating Tapered Punch Chisels with 10.2 mm Shank



**BP909TTP**

| L      |            |
|--------|------------|
| 165 mm | 1 BP909TTP |

Rotating Edging Chisels with 10.2 mm Shank



**BP909TE**

| L      |           |
|--------|-----------|
| 139 mm | 1 BP909TE |

Rotating Hammer Chisels with 10.2 mm Shank



**BP909TH**

| L      |           |
|--------|-----------|
| 108 mm | 1 BP909TH |

Rotating Straight Punch Chisels with 10.2 mm Shank



**BP909TSP**



165 mm



1 BP909TSP

Non-Rotating Flat Chisels with 10.2 mm Shank



**BP909NF**



190.5 mm



1 BP909NF

Non-Rotating Edging Chisels with 10.2 mm Shank



**BP909NE**



173 mm



1 BP909NE

Air Riveters 880 kg pulling force



**BP277K**

**BAR**



6.3 bar

14



8 BP277K

Air Riveters 1600 kg pulling force



**BP125A**

**BAR**



6.3 bar

19



6 BP125A

Carbide Tips for Air Engraving Pen



**BP79912**



10 g



1 BP79912

Air Caulking Guns with 300 ml Cartridge Applicator



**BP215A**

**BAR**

3.5-4.8 bar



10 BP215A

**PAINT GUNS**

HVLP Spray Painting Guns



Air Engraving Markers with Low Vibration



**BP799**



13,000 min<sup>-1</sup>

**BAR**

6.3 bar



1 BP799

**BPHVLP01**



0.7 kg

**BAR**

2-2.8 bar



1 BPHVLP01





Nozzle Set for BPHVLP01 HVLP Painting Spray Guns



**BPHVLP**

|        |   |            |
|--------|---|------------|
|        |   |            |
| 1.2 mm | 1 | BPHVLP0112 |
| 1.4 mm | 1 | BPHVLP0114 |
| 1.7 mm | 1 | BPHVLP0117 |
| 2.0 mm | 1 | BPHVLP0120 |

**BLOWING & CLEANING TOOLS**

Air Blow Guns with Brass Inlet



**BP218  
BAR**

|         |         |
|---------|---------|
|         |         |
| 6.3 bar | 1 BP218 |

Air Blow Guns with Brass Inlet and Removable Safety Tip



**BP219  
BAR**

|         |         |
|---------|---------|
|         |         |
| 6.3 bar | 1 BP219 |

Air Blow Guns with Brass Inlet and Removable Safety Tip Long Nozzle



**BP219L  
BAR**

|         |          |
|---------|----------|
|         |          |
| 6.3 bar | 1 BP219L |

Air Blow Guns with Brass Inlet 1 m Extra Long Nozzle



**BP219XL  
BAR**

|         |           |            |
|---------|-----------|------------|
|         |           |            |
| 6.3 bar | 100 l/min | 10 BP219XL |

Air Blow Vacuum Guns with Removable Safety Tip



**BP219V  
BAR**

|         |          |
|---------|----------|
|         |          |
| 6.3 bar | 1 BP219V |

Cleaning Guns with Steel Nozzle



**BPN010  
BAR**

|         |               |          |
|---------|---------------|----------|
|         |               |          |
| 6.2 bar | 6000-7500 min | 1 BPN010 |

**AIR TOOLS ACCESSORIES & EQUIPMENT**

Magnetic Holders for Impact and Torque Wrenches



**BP500**

|          |         |  |
|----------|---------|--|
|          |         |  |
| 0.380 kg | 1 BP500 |  |

1/2" Filter Regulator Units



**BP254**

|                      |           |         |
|----------------------|-----------|---------|
|                      |           |         |
| max 3800 L/min l/min | 1-8.5 bar | 1 BP254 |

1/2" Filter Regulator and Lubricator Units



**BP255**

|                 |            |   |       |
|-----------------|------------|---|-------|
|                 | <b>BAR</b> |   |       |
| max 3,800 l/min | 1-8.5 bar  | 1 | BP255 |

Additional clean dry air outlet for 1/2" filter regulator and lubricator units with type T clean dry air outlet



**BP255T-1**

|                |            |   |          |
|----------------|------------|---|----------|
|                | <b>BAR</b> |   |          |
| max 3800 l/min | 1-8.5 bar  | 1 | BP255T-1 |

Spiral Air Hoses with Threaded Connector 13 mm



**BPH1310**

|              |      |   |          |
|--------------|------|---|----------|
|              |      |   |          |
| 1/2"-1/2" in | 10 m | 1 | BPH1310A |

1/4" Inline Lubricators



**BPN251**

|         |          |   |        |  |
|---------|----------|---|--------|--|
|         |          |   |        |  |
| 1/4" in | 0.100 kg | 1 | BPN251 |  |

Spiral Air Hoses with Threaded Connector 10 mm



**BPH1010**

|                  |      |   |          |
|------------------|------|---|----------|
|                  |      |   |          |
| 1/4"-1/4" NPT in | 10 m | 1 | BPH1010A |
| 1/4"-1/4" BSP in | 10 m | 1 | BPH1010B |

Speed Control Adaptors for Rewinding Speed Control



**BPHRSC**

|                  |   |        |
|------------------|---|--------|
|                  |   |        |
| 76 x 88 x 114 mm | 1 | BPHRSC |

1/2" Filter Regulator and Lubricator Units with Type T Clean Dry Air Outlet



**BP255T**

|                |            |   |        |
|----------------|------------|---|--------|
|                | <b>BAR</b> |   |        |
| max 3800 l/min | 1-8.5 bar  | 1 | BP255T |

Air Hose Reels with 145° Swivel Steel Bracket and Optional Speed Control Adaptor



**BPHRC815/1015**

|       |        |   |           |
|-------|--------|---|-----------|
|       |        |   |           |
| 8 mm  | 15 m   | 1 | BPHRC815  |
| 10 mm | 14+1 m | 1 | BPHRC1015 |

Air Hose Reels with 145° Swivel Steel Bracket



**BPHRC1020/1316**

|       |        |   |           |
|-------|--------|---|-----------|
|       |        |   |           |
| 10 mm | 20 m   | 1 | BPHRC1020 |
| 13 mm | 15+1 m | 1 | BPHRC1316 |



Air Hose Reels with 90° Swivel Base



**BPHRO1315**



13 mm

13+2 mm

1 BPHRO1315

1/4" Swivel Air Connectors



**BPSJ**



1/4" in

1 BPSJ

1/4" Swivel Air Connectors with Rotation Lock System



**BPSJL**



1/4" in

1 BPSJL





## Cordless Power Tools



## IMPACT WRENCHES

12 V 1/4" Square Drive Cordless Impact Wrenches



**BCL31IW1**



1 BCL31IW1

12 V

1/4"

14.4 V 3/8" Square Drive Cordless Brushless Impact Wrench Kit



**BCL32IW1K1**



110 x 310 x 390 mm 3.6 kg 1 BCL32IW1K1

BCL32IW1

BCL32B1x 2

BCL31C1

18 V 1/2" Square Drive Cordless Impact Wrenches



**BCL33IW1**



18 V 1/2" 1 BCL33IW1

12 V 1/4" Square Drive Cordless Impact Wrench Kit



**BCL31IW1K1**



1 BCL31IW1K1

110 x 310 x 390 mm 3.1 kg

BCL31B1x 2

BCL31C1

BCL31IW1

18 V 1/2" Square Drive Cordless Impact Wrench Kit



**BCL33IW1K1**



110 x 310 x 390 mm 5.77 kg 10 BCL33IW1K1

BCL33C1

BCL33IW1

BCL33B3x 2

18 V 1/2" Square Drive Cordless Brushless Impact Wrench Kit



**BCL33IW2K1**



110 x 310 x 390 mm 6.47 kg 1 BCL33IW2K1

BCL33IW2

BCL33C1

BCL33B3x 2

14.4 V 3/8" Square Drive Cordless Brushless Impact Wrenches



**BCL32IW1**



1 BCL32IW1

14.4 V

3/8"

18 V 1/2" Square Drive Cordless Brushless Impact Wrenches



**BCL33IW2**



18 V 1/2" 1 BCL33IW2

## RATCHETS

12 V 1/4" Cordless Square Drive Ratchet Wrenches



**BCL31R1**



12 V 1/4" 1 BCL31R1



12 V 1/4" Cordless Square Drive Ratchet Wrench Kit



**BCL31R1K1**

110 x 310 x 390 mm 3.1 kg 1 BCL31R1K1

BCL31B1x 2

BCL31C1

BCL31R1

**DRILLS & SCREWDRIVERS**

18 V 1/2"-13 mm Cordless Brushless Drill Drivers



**BCL33D1**

18 V 1/2 in 1 BCL33D1

18 V 1/2"-13 mm Cordless Drill Driver Kit



**BCL33D1K1**

110 x 310 x 390 mm 3.7 kg 1 BCL33D1K1

BCL33C1

BCL33D1

BCL33B1x 2

12 V 3/8"-10 mm Cordless Drill Drivers



**BCL31D1**

12 V 360/1550 min 1 BCL31D1

12 V 3/8"-10 mm Cordless Drill Driver Kit



**BCL31D1K1**

110 x 310 x 390 mm 3.15 kg 1 BCL31D1K1

BCL31B1x 2

BCL31C1

BCL31D1

12 V 1/4" Cordless Compact Impact Drivers with Quick Release Hex Drive



**BCL31IS1**

12 V 1/4 in 1 BCL31IS1

12 V 1/4" Cordless Compact Impact Driver with Quick Release Hex Drive Kit



**BCL31IS1K1**

110 x 310 x 390 mm 3.1 kg 1 BCL31IS1K1

BCL31B1x 2

BCL31IS1

BCL31C1

12 V 1/4" Cordless Two Speed Drivers



**BCL31SD1**

12 V 1/4 in 1 BCL31SD1

12 V 1/4" Cordless Two Speed Driver Kit



**BCL31SD1K1**

110 x 310 x 390 mm 2.99 kg 1 BCL31SD1K1

BCL31SD1

BCL31B1x 2

BCL31C1



## GRINDERS, SANDERS & POLISHERS

14.4 V Cordless 2" Sanders and 3" Polishers



**BCL32SP1**

**V** 14.4 V 1900/6900 min 1 BCL32SP1

18 V Cordless Orbital Angle Polishers with 5" Pad



**BCL33AP1**

**V** 18 V 1100-3500 min 1 BCL33AP1

14.4 V Cordless 2" Sanders and 3" Polishers Kit



**BCL32SP1K1**

265 x 290 x 480 mm 3.29 kg 1 BCL32SP1K1

BCL32SP1   
 BCL32B1x 2   
 BCL31C1

18 V Cordless Orbital Angle Polisher Kit with 5" Pad



**BCL33AP1K1**

265 x 290 x 480 mm 5.78 kg 1 BCL33AP1K1

BCL33AP1   
 BCL33B3x 2   
 BCL33C1

14.4 V 6 mm Cordless Collet Die Grinders



**BCL32DG1**

**V** 14.4 V 21000 min 1 BCL32DG1

14.4 V 6 mm Cordless Collet Die Grinder Kit



**BCL32DG1K1**

110 x 310 x 390 mm 3.2 kg 1 BCL32DG1K1

BCL32DG1   
 BCL32B1   
 BCL31C1

14.4 V Cordless Greaser Kit with GR-400 Container



**BCL32G1K1**

265 x 290 x 480 mm 5.22 kg 1 BCL32G1K1

BCL32G1   
 BCL31C1   
 BCL32B1x 2

## CUTTING TOOLS

14.4 V Cordless Reciprocating Saws



**BCL32RS1**

**V** 14.4 V 3000 min 1 BCL32RS1

14.4 V Cordless Reciprocating Saw Kit



**BCL32RS1K1**

265 x 290 x 480 mm 3.5 kg 1 BCL32RS1K1

BCL32RS1



BCL32B1x 2



BCL31C1



## GREASERS

14.4 V Cordless Greasers with GR-400 Container Capacity



**BCL32G1**

**V**



14.4 V

400 g

1 BCL32G1

## BATTERIES & CHARGERS

12 V 2 Ah Lithium-Ion Batteries



**BCL31B1**

**V**



12 V

2 A-h

1 BCL31B1

14.4 V 2 Ah Lithium-Ion Batteries



**BCL32B1**

**V**



14.4 V

2 A-h

1 BCL32B1

18 V 2 Ah Lithium-Ion Batteries



**BCL33B1**

**V**



18 V

2 A-h

1 BCL33B1

18 V 5 Ah Lithium-Ion Batteries



**BCL33B3**

**V**



18 V

2 A-h

1 BCL33B3

12 V-14.4 V 3 A Battery Chargers



**BCL31C1**

**V**<sub>in</sub>

**V**<sub>out</sub>



220 V

12/14.4 V

1 BCL31C1

18 V 2.3 A Battery Chargers



**BCL33C1**

**V**<sub>in</sub>

**V**<sub>out</sub>



220 V

18 V

1 BCL33C1

18 V 3.4 A Quick Battery Chargers



**BCL33C2**

**V**<sub>in</sub>

**V**<sub>out</sub>



220 V

18 V

1 BCL33C2





**BAHCO**





## Automotive Tools





## ENGINE TOOLS

Timing kit for FCA Group 1.4 Multiair engines



### BE501101



68 x 225 x 280 mm

1 BE501101

BE50110101



BE50110102



BE50110103



BE50110104



Timing kit for FCA Group 0.9 petrol Twinair



### BE501102



68 x 225 x 280 mm

1 BE501102

BE50110201



BE50110202



BE50110203



Timing kit for FCA Group 1.6-1.9-2.0-2.4 diesel



### BE501203



68 x 225 x 280 mm

1 BE501203

BE50120301



BE50120302



BE50120303



BE50120305



BE50110103



BMW crankshaft harmonic balancer holder



### BE502104



60 x 98 x 269 mm

1726 g

8 BE502104

BMW crankshaft holding tool



### BE502106



80 x 70 x 260 mm

10 BE502106

Timing kit for FCA Group 1.3 JTD MJ



### BE501204



68 x 225 x 280 mm

1 BE501204

BE50120401



BE50120402



BE50120403



BE50120404



BE50120405



Timing kit for BMW 1.8-2.0 petrol

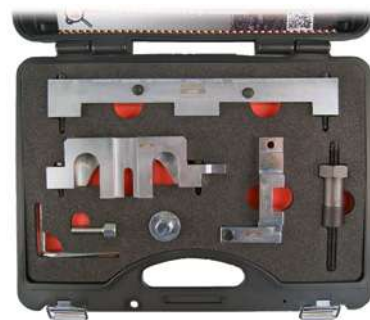

### BE502101



95 x 270 x 350 mm

1 BE502101

BE50210101



BE50210102



BE50210103



BE50210104



BE50210105



BE50210106



BE50210107



Timing kit for BMW 1.6 petrol

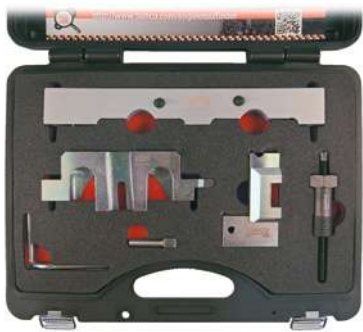

**BE502102**



270 x 95 x 355 mm



1 BE502102

BE50210103



BE50210105



BE50210107



BE50210201



BE50210202



BE50210203



Timing kit for BMW 1.6-2.0 petrol

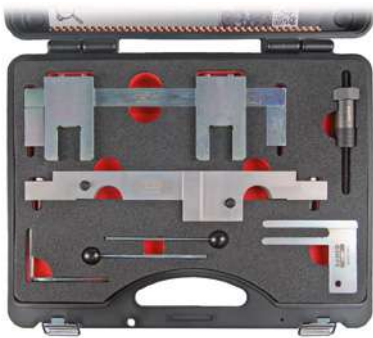

**BE502103**



80 x 300 x 375 mm



1 BE502103

BE50210301



BE50210302



BE50210303



BE50210305



BE50210105



BE50210107



Timing kit for BMW 2.0 - 2.5 - 3.0 diesel



**BE502204**



68 x 225 x 280 mm



1 BE502204

BE50220401



BE50220403



BE50220404



BE50220405



BE50210305



Timing kit for BMW Mini 1.6-2.0 diesel



**BE503201**



68 x 225 x 280 mm



1 BE503201

BE50320101



BE50320102



BE50320103



BE50320105



BE50210305



Timing kit for MINI-PSA 1.4-1.6 petrol



**BE504102**



95 x 270 x 350 mm



1 BE504102

BE50410201



BE50410202



BE50410203



BE50410204



BE50410206



BE50210105



Timing kit for MINI-PSA 1.6 diesel



**BE504201**



50 x 50 x 220 mm



1 BE504201

BE50420101



BE50420102



BE50420103



BE50420104



BE50210305



Timing kit for Ford 1.25-1.4-1.6 petrol



**BE505101**



68 x 225 x 280 mm

1 BE505101

- BE50510101
- BE50510102
- BE50510103
- BE50510104
- BE50510105
- BE50510106

Timing kit for Ford 1.0 EcoBoost petrol

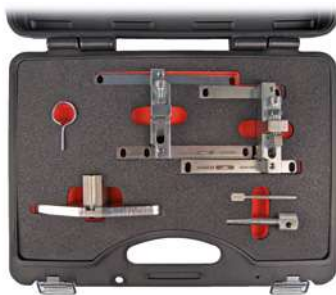

**BE505102**



95 x 270 x 350 mm

1 BE505102

- BE50510201
- BE50510202
- BE50510203
- BE50510204
- BE50420102
- BE50510102

Timing kit for Ford 2.0 - 2.2 - 2.4 Duratorq TDCI 16v diesel



**BE505203**



95 x 270 x 350 mm

1 BE505203

- BE50520301
- BE50520302
- BE50520303
- BE50520304
- BE50520305
- BE50520306
- BE50520307

Timing kit for Ford 1.4-1.6-1.8-2.0-2.2-2.5 diesel



**BE505204**



95 x 270 x 350 mm

1 BE505204

- BE50520401
- BE50520402
- BE50520403
- BE50520404
- BE50520405
- BE50520407
- BE50520411
- BE50520412
- BE50520413
- BE50510104
- BE50420102
- BE50420103
- BE50420104
- BE50510106

Timing kit for Opel 1.0-1.2-1.4 petrol



**BE506101**



50 x 50 x 160 mm

1 BE506101

- BE50610101
- BE50610102
- BE50610103
- BE50610104
- BE50610105

Timing kit for Opel 1.4-1.6-1.8 petrol



**BE506102**



68 x 225 x 280 mm

1 BE506102

- BE50610201
- BE50610202
- BE50610203
- BE50610204
- BE50610205
- BE50610206



Timing kit for Opel 1.0-1.2-1.4 Ecoflex petrol



**BE506103**



95 x 270 x 350 mm



1 BE506103

BE50610302



BE50610304



BE50610102



BE50610103



BE50610105



Timing kit for Opel 2.0 diesel



**BE506204**



85 x 300 x 375 mm



1 BE506204

BE50620401



BE50620402



BE50620403



BE50620404



BE50620405



Timing kit for PSA 1.0-1.1-1.4-1.6-1.8-2.0-2.2 petrol



**BE507101**



95 x 270 x 350 mm



1 BE507101

BE50710103



BE50710104



BE50710105



BE50710106



BE50710107



BE50710108



BE50710109



BE50710110



BE50710111



BE50710112



BE50710101



BE50710102



BE50710113



BE50710114



BE50710116



BE50710117



BE50710118



BE50710119



BE50420104



Timing kit for PSA 1.0-1.2 petrol



**BE507102**



68 x 225 x 280 mm



1 BE507102

BE50710201



BE50710202



Timing kit for PSA 1.4-1.5-1.6-1.9-2.0-2.2-2.5 diesel



**BE507203**



85 x 300 x 375 mm



1 BE507203

BE50720301



BE50720302



BE50720304



BE50720305



BE50720307



BE50720308



BE50720310



BE50720312



BE50720314



BE50720317



BE50720318



BE50720319



BE50720320



BE50720321



BE50720322



BE50720323



BE50520404



BE50520411



BE50710107



BE50710104



BE50710113



BE50710110



BE50710102



BE50710106



BE50420102



BE50420103



Timing kit for Renault/Dacia 1.2-1.4-1.6-1.8-2.0 petrol

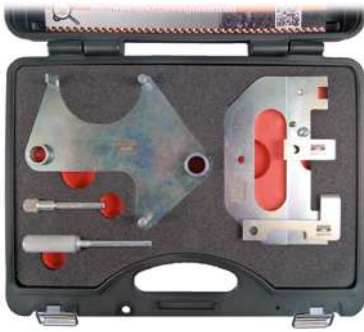

**BE508101**



95 x 270 x 350 mm



1 BE508101

|            |  |
|------------|--|
| BE50810101 |  |
| BE50810102 |  |
| BE50810103 |  |
| BE50810104 |  |
| BE50810105 |  |
| BE50810106 |  |

Timing kit for Renault 1.5-1.9-2.2-2.5 diesel



**BE508202**



80 x 300 x 375 mm



1 BE508202

|            |  |
|------------|--|
| BE50820201 |  |
| BE50820202 |  |
| BE50820203 |  |
| BE50820204 |  |
| BE50820205 |  |
| BE50820206 |  |
| BE50820207 |  |
| BE50820208 |  |
| BE50820209 |  |
| BE50820211 |  |
| BE50810103 |  |
| BE50810104 |  |

Timing kit for Renault 2.0 diesel



**BE508203**



68 x 225 x 280 mm



1 BE508203

|            |  |
|------------|--|
| BE50820301 |  |
| BE50820302 |  |
| BE50820303 |  |
| BE50820304 |  |
| BE50210305 |  |

Timing set for Renault-Nissan 1.6 diesel



**BE508204**



95 x 270 x 350 mm



1 BE508204

|            |  |
|------------|--|
| BE50820402 |  |
| BE50820403 |  |
| BE50820404 |  |
| BE50820302 |  |

Timing kit for VW Group 1.4-1.6-1.8-2.0 petrol



**BE509101**



80 x 300 x 375 mm



1 BE509101

|            |  |
|------------|--|
| BE50910101 |  |
| BE50910102 |  |
| BE50910103 |  |
| BE50910104 |  |
| BE50910105 |  |
| BE50910106 |  |
| BE50910107 |  |
| BE50910108 |  |
| BE50910109 |  |
| BE50910110 |  |
| BE50910111 |  |
| BE50910112 |  |
| BE50910114 |  |
| BE50520302 |  |

Timing kit for VW Group 1.2-1.4-1.6 petrol



**BE509102**



68 x 225 x 280 mm



1 BE509102

|            |  |
|------------|--|
| BE50910201 |  |
| BE50910202 |  |
| BE50910203 |  |
| BE50910205 |  |
| BE50910206 |  |
| BE50910207 |  |
| BE50520302 |  |



Timing kit for VW Group 1.2 TSI petrol



**BE509103**



50 x 50 x 210 mm

1 BE509103

BE50910302



BE50910203



Timing kit for VW Group 1.0 petrol



**BE509104**



68 x 225 x 280 mm

1 BE509104

BE50910401



BE50910402



BE50910403



BE50910404



BE50910203



Timing kit for VW Group 1.2-1.4-1.6-1.9-2.0 diesel



**BE509205\_1**



60 x 60 x 220 mm

1 BE509205

BE50910103



BE50920602



BE50920603



Timing kit for VW Group 1.9-2.0 diesel



**BE509206**



60 x 60 x 220 mm

1 BE509206

BE50920602



BE50910103



BE50920703



Timing kit for VW Group 1.2-1.4-1.6-1.9-2.0 diesel



**BE509207**



95 x 270 x 350 mm

1 BE509207

BE50920703



BE50920707



BE50920708



BE50920709



BE50920710



BE50920711



BE50910103



BE50910112



BE50920602



BE50920603



BE50910109



BE50510102



Timing kit for Volvo 1.6 - 1.8 - 1.9 - 2.0 - 2.3 - 2.4 - 2.5 petrol



**BE510101**



60 x 60 x 355 mm

1 BE510101

BE51010101



BE51010102



BE51010103



Timing kit for Volvo 1.6 - 1.8 - 2.0 16v. petrol



**BE510102**



50 x 50 x 220 mm

1 BE510102

BE51010201



BE51010202



BE50510102



BE50510105



BE50510106



Timing kit for Volvo 1.6 - 2.0 diesel



**BE510203**



68 x 225 x 280 mm



1 BE510203

BE50420102



BE50420103



BE50420104



BE50520407



BE50520411



BE50510104



Crankshaft pulley holding tool for Volvo



**BE510304**



50 x 145 x 265 mm



1 BE510304

Timing kit for Saab 1.8i petrol



**BE511101**



50 x 50 x 220 mm



1 BE511101

BE51110101



BE51110102



BE50610201



BE50610204



Timing kit for Saab 1.6t petrol



**BE511102**



50 x 50 x 207 mm



1 BE511102

BE50610201



BE50610202



BE50610205



BE50610203



Timing kit for Saab 1.9 - 2.0 - 2.2 Tid diesel



**BE511203**



80 x 300 x 375 mm



1 BE511203

BE51120301



BE51120302



BE51120303



BE51120304



BE51120305



BE50120302



BE50120303



BE50120305



BE50610201



Universal set for removing broken glow plugs



**BE513201**



95 x 270 x 350 mm



2.10 kg



1 BE513201

BE51320101



BE51320102



BE51320103



BE51320104



BE51320105



BE51320106



BE51320107



BE51320108



BE51320109



BE51320110



BE51320111



BE51320112



BE51320113



BE51320114



Sprocket holding wrench universal



**BE523106**



410 mm



1 BE523106

Adjustable Universal Camshaft Locking Tool



**BE5100**



345 x 150 x 85 mm

1 BE5100

Stretch belt installer/remover



**BE230**



35 x 145 x 155 mm

1 BE230

Alternator extractor 24 pcs set



**BE500P24**



55 x 270 x 370 mm

- 5 BE500P24
- 1 BE500P2401
- 1 BE500P2402
- 1 BE500P2403
- 1 BE500P2404
- 1 BE500P2405
- 1 BE500P2406
- 1 BE500P2407
- 1 BE500P2408



- 1 BE500P2409
- 1 BE500P2410
- 1 BE500P2411
- 1 BE500P2412
- 1 BE500P2413
- 1 BE500P2414
- 1 BE500P2415
- 1 BE500P2416
- 1 BE500P2417
- 1 BE500P2418
- 1 BE500P2419
- 1 BE500P2420
- 1 BE500P2421
- 1 BE500P2422
- 1 BE500P2423
- 1 BE500P2424

Diesel compression tester



**BE5401D**



105 x 325 x 410 mm

1 BE5401D

Digital petrol engine compressor tester



**BE5400P**



70 x 160 x 260 mm

1 BE5400P

Belt tension tester



**BE239**



38 x 82 x 95 mm 95 mm

1 BE239

Electronic belt tension tester



**BE240**

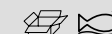

60 x 270 x 315 mm 315 mm

1 BE240

Data book of tension values for timing and accessory belts, synchronous, V&V and ribbed shape.



**BE240-CAT**



710 g

1 BE240-CAT



Laser thermometer



**BLT550**

-50 +550 °C 
 40 x 95 x 145 mm 
 10 
 BLT550

Quick fluid stopper and injector hose separator set



**BE257**

68 x 225 x 280 mm 
 8 
 BE257  
 1 BE25710  
 1 BE25718  
 1 BE2572  
 1 BE2576

Universal injector removal tool kit



**BE512201**

140 x 415 x 600 mm 
 1 
 BE512201

|            |  |
|------------|--|
| BE51220101 |  |
| BE51220102 |  |
| BE51220103 |  |
| BE51220104 |  |
| BE51220105 |  |
| BE51220106 |  |
| BE51220107 |  |
| BE51220108 |  |
| BE51220109 |  |
| BE51220110 |  |
| BE51220111 |  |
| BE51220112 |  |
| BE51220113 |  |
| BE51220114 |  |
| BE51220115 |  |
| BE51220116 |  |
| BE51220117 |  |
| BE51220118 |  |
| BE51220119 |  |
| BE51220120 |  |

Injector puller set



**BE1311P13**

80 x 355 x 445 mm 
 1 
 BE1311P13

Injection nozzle socket set; 25, 27, 29 & 30 mm



**BE1310P4**

68 x 225 x 225 mm 
 1 
 BE1310P4

1/2" impact socket for removing Bosch and Siemens injection nozzles



**BE1310P425-BE1310P430**

|       |        |   |            |
|-------|--------|---|------------|
|       |        |   |            |
| 25 mm | 1/2 in | 1 | BE1310P425 |
| 27 mm | 1/2 in | 1 | BE1310P427 |
| 29 mm | 1/2 in | 1 | BE1310P429 |
| 30 mm | 1/2 in | 1 | BE1310P430 |

Diesel injector seat cleaner set



**BE1320S17**

76 x 266 x 355 mm 
 10 
 BE1320S17



Diesel injector seat cutter



**BE1315P7**



|                   |   |           |
|-------------------|---|-----------|
| 68 x 225 x 280 mm | 1 | BE1315P7  |
| 25 x 180 x 275 mm | 1 | BE1315P71 |
| 20 x 93 x 175 mm  | 1 | BE1315P72 |
| 19 x 93 x 140 mm  | 1 | BE1315P73 |
| 16 x 93 x 140 mm  | 1 | BE1315P74 |
| 20 x 56 x 96 mm   | 1 | BE1315P75 |
| 20 x 56 x 96 mm   | 1 | BE1315P76 |
| 23 x 56 x 96 mm   | 1 | BE1315P77 |

Slide hammer / Washer and wiper puller



**BE1300SH**



|        |                  |    |          |
|--------|------------------|----|----------|
| 235 mm | 50 x 50 x 235 mm | 10 | BE1300SH |
|--------|------------------|----|----------|

Special Internal Valve Seat Removal Tool for Denso Common Rail Injectors



**BE1312DNS**



|    |           |
|----|-----------|
| 12 | BE1312DNS |
|----|-----------|

Diesel injector washer puller



**BE1300**



|        |                  |   |        |
|--------|------------------|---|--------|
| 230 mm | 35 x 35 x 260 mm | 1 | BE1300 |
|--------|------------------|---|--------|

Valve lapper set



**BE762**



|                  |      |    |       |
|------------------|------|----|-------|
| 30 x 90 x 315 mm | 68 g | 12 | BE762 |
|------------------|------|----|-------|

Valve spring compressor removal tools



**BE76101**



|                   |   |         |
|-------------------|---|---------|
| 40 x 200 x 290 mm | 1 | BE76101 |
|-------------------|---|---------|

Copper injector sealing ring set



**BE1305P450**



|                   |   |            |
|-------------------|---|------------|
| 40 x 140 x 205 mm | 1 | BE1305P450 |
|-------------------|---|------------|

Sets of 30 washers for injectors

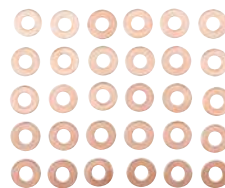

**BE1305P450B**



- 1 BE1305P450WS01
- 1 BE1305P450WS02
- 1 BE1305P450WS03
- 1 BE1305P450WS04
- 1 BE1305P450WS05
- 1 BE1305P450WS06
- 1 BE1305P450WS07
- 1 BE1305P450WS08
- 1 BE1305P450WS09
- 1 BE1305P450WS10
- 1 BE1305P450WS11
- 1 BE1305P450WS12
- 1 BE1305P450WS13
- 1 BE1305P450WS14
- 1 BE1305P450WS15

Common rail 8 injectors fuel return tester



**BE5350**



|                   |   |          |
|-------------------|---|----------|
| 84 x 341 x 447 mm | 5 | BE5350   |
| 10 x 56 x 96 mm   | 1 | BE5350C1 |
| 10 x 56 x 96 mm   | 1 | BE5350C2 |
| 10 x 56 x 96 mm   | 1 | BE5350C3 |
| 10 x 56 x 96 mm   | 1 | BE5350C4 |
| 115 x 65 x 205 mm | 1 | BE5350C5 |





Diesel injector tester



**BE13ZL11**

480 x 230 x 280 mm 4.24 kg 1 BE13ZL11

Tamper Torx® Bit/Socket Set, 1/4"



**BE5008**

40 x 20 x 175 mm 1 BE5008

BE5008-45, BE5008-27, BE5008-25,  
BE5008-40, BE5008-30, BE5008-10,  
BE5008-20, BE5008-15

Tamper Torx socket



**BE5008-10/BE5008-45**

|    |   |           |
|----|---|-----------|
| 10 | 1 | BE5008-10 |
| 15 | 1 | BE5008-15 |
| 20 | 1 | BE5008-20 |
| 25 | 1 | BE5008-25 |
| 27 | 1 | BE5008-27 |
| 30 | 1 | BE5008-30 |
| 40 | 1 | BE5008-40 |
| 45 | 1 | BE5008-45 |

Glow plug socket set



**BE1GP5**

1/4 in 110 x 240 x 40 mm 1 BE1GP5

BE1GP514, BE1GP510, BE1GP512,  
BE1GP58, BE1GP59

Glow plug puller



**BE1205**

130 mm 35 x 35 x 130 mm 1 BE1205

Sets of 5 inserts/coils for repairing/  
restoring damaged glow plug threads



**BE1210P110x**

|          |      |   |             |
|----------|------|---|-------------|
| M8x1     | 50 g | 1 | BE1210P1101 |
| M10x1    | 50 g | 1 | BE1210P1102 |
| M10x1,25 | 50 g | 1 | BE1210P1103 |

Glow plug chamber cleaning set



**BE1200P6**

50 x 115 x 260 mm 1 BE1200P6

Reamer for BE1200P6



**BE1200P6AC1**

50 x 158 x 192 mm 1 BE1200P6AC1

T-handle for glow plug sockets



**BE1GP5-T**

1/4 in 400 mm 10 BE1GP5-T

### Glow plug flex sockets



#### BE1GP58/BE1GP514



| Ø     | L     | Icon | Part No.   |
|-------|-------|------|------------|
| 8 mm  | 70 mm |      | 1 BE1GP58  |
| 9 mm  | 70 mm |      | 1 BE1GP59  |
| 10 mm | 70 mm |      | 1 BE1GP510 |
| 12 mm | 70 mm |      | 1 BE1GP512 |
| 14 mm | 70 mm |      | 1 BE1GP514 |

### Spark Plug Articulated Extension Tool



#### BE1SP1F



| Icon | Dimensions | Quantity | Part No. |
|------|------------|----------|----------|
|      | 30 mm      | 21       | BE1SP1F  |

### 3/8" Square Drive Spark Plug Sockets



#### 7402GPR



| Icon | Quantity | Part No.   |
|------|----------|------------|
|      | 120      | 7402GPR-16 |
|      | 120      | 7402GPR-18 |
|      | 100      | 7402GPR-21 |

### Glow plug thread repair set



#### BE1210P11

| Icon | Dimensions        | Quantity | Part No.    |
|------|-------------------|----------|-------------|
|      | 50 x 120 x 260 mm | 1        | BE1210P11   |
|      | 112 x 13 x 95 mm  | 1        | BE1210P9AC1 |

### Spark plug sockets with magnet, 3/8"



#### 7406ZZ



| Icon | Dimensions | Quantity | Part No.    |
|------|------------|----------|-------------|
|      | 16 mm      | 65 mm    | 1 7406ZZ-16 |
|      | 21 mm      | 64 mm    | 1 7406ZZ-21 |

### Spark plug wrench



#### BE1SP



| Icon | Dimensions | Quantity | Part No.    |
|------|------------|----------|-------------|
|      | 3/8 in     | 252 mm   | 10 BE1SP16L |
|      | 3/8 in     | 252 mm   | 1 BE1SP14L  |

### Spark Plug Pliers



#### BE1P

| Icon | Dimensions | Quantity         | Part No. |
|------|------------|------------------|----------|
|      | 290 mm     | 20 x 50 x 290 mm | 1 BE1P   |

### 1/2" Square Drive Spark Plug Sockets



#### 7805GPR



| Icon | Dimensions | Quantity | Part No.       |
|------|------------|----------|----------------|
|      | 16 mm      | 64 mm    | 120 7805GPR-16 |
|      | 21 mm      | 64 mm    | 100 7805GPR-21 |

### Spark plug wrenches



#### BE1T14/BE1T16/BE1T21



| Icon | Dimensions | Quantity  | Part No. |
|------|------------|-----------|----------|
|      | 14 mm      | 65/310 mm | 1 BE1T14 |
|      | 16 mm      | 63/450 mm | 1 BE1T16 |
|      | 21 mm      | 67/450 mm | 1 BE1T21 |



BE110014 / Tap: M14x1.25P



**BE110014/BE110015**

|      |   |          |
|------|---|----------|
|      |   |          |
| 55 g | 1 | BE110014 |
| 55 g | 1 | BE110015 |

Insert coils for repairing spark plug threads



**BE1100AC1/BE1100AC2**

|        |   |           |
|--------|---|-----------|
|        |   |           |
| 9.4 mm | 1 | BE1100AC1 |
| 15 mm  | 1 | BE1100AC2 |

Ribe 1/2" socket with bit, suitable for engines



**BE5102**

|                   |   |        |
|-------------------|---|--------|
|                   |   |        |
| 65 x 225 x 225 mm | 1 | BE5102 |

BE51026, BE51025, BE510210,  
BE510211, BE510212, BE510213,  
BE51027, BE51028, BE51029

1/2" socket drivers with Ribe bits



**BE51025-BE510213**

|      |        |   |          |
|------|--------|---|----------|
|      |        |   |          |
| RM5  | 100 mm | 1 | BE51025  |
| RM6  | 100 mm | 1 | BE51026  |
| RM7  | 100 mm | 1 | BE51027  |
| RM8  | 100 mm | 1 | BE51028  |
| RM9  | 100 mm | 1 | BE51029  |
| RM10 | 100 mm | 1 | BE510210 |
| RM11 | 100 mm | 1 | BE510211 |
| RM12 | 100 mm | 1 | BE510212 |
| RM13 | 100 mm | 1 | BE510213 |

XZN 1/2" socket with bit, suitable for engines



**BE5103**

|                   |   |        |
|-------------------|---|--------|
|                   |   |        |
| 65 x 225 x 225 mm | 1 | BE5103 |

BE51036, BE51038, BE510310,  
BE510312, BE51035, BE510314

1/2" socket drivers with XZN bits



**BE51035-BE510314**

|     |        |   |          |
|-----|--------|---|----------|
|     |        |   |          |
| M5  | 140 mm | 1 | BE51035  |
| M6  | 140 mm | 1 | BE51036  |
| M8  | 140 mm | 1 | BE51038  |
| M10 | 140 mm | 1 | BE510310 |
| M12 | 140 mm | 1 | BE510312 |
| M14 | 140 mm | 1 | BE510314 |

Spark plug wire brush



**52**

|        |    |    |
|--------|----|----|
|        |    |    |
| 150 mm | 12 | 52 |

General purpose utility wire brush



**782-U**

|        |   |       |
|--------|---|-------|
|        |   |       |
| 285 mm | 1 | 782-U |

Terminal brush



**2555**

|       |   |      |
|-------|---|------|
|       |   |      |
| 85 mm | 1 | 2555 |

Spark plug thread restorer set



**BE1100**

68 x 225 x 280 mm 1.55 kg 8 BE1100

Milling cutter



**BE110001**

60 g 1 BE110001

Piston Ring Tongs



**BE74-55100/BE74-80120**

55-100 mm 20 x 130 x 205 mm 1 BE74-55100  
80-120 mm 20 x 145 x 220 mm 1 BE74-80120

Piston ring tightener



**BE74-57125/BE74-90175**

80 mm 57-125 mm 1 BE74-57125  
165 mm 90-175 mm 1 BE74-90175  
80 mm 57-125 mm 1 BE74-57125L

Refractometer



**3046-REF**

150 mm 1 3046-REF

Antifreeze liquid tester



**BE401**

50 x 50 x 235 mm 235 mm 1 BE401

Cooling system pressure tester set



**BE400P24**

127 x 435 x 510 mm 1 BE400P24

Radiator pressure pump with gauge for testing cooling or heating systems



**BE400P241**

**BAR PSI** 1 BE400P241  
0-2,5 bar 0-36 psi

Piston Ring Tongs



Antifreeze liquid tester



Radiator cap test connector R124/R123



**BE400P242**

0.035 kg 1 BE400P242



Radiator cap test connector R123/R125



**BE400P243**

|         |   |           |
|---------|---|-----------|
|         |   |           |
| 0.06 kg | 1 | BE400P243 |

Radiator cap tester for cooling system



**BE400P2402**

|       |   |            |
|-------|---|------------|
|       |   |            |
| 65 mm | 1 | BE400P2402 |

Adaptor for testing the cooling system



**BE400P2405**

|          |   |            |
|----------|---|------------|
|          |   |            |
| 0.065 kg | 1 | BE400P2405 |

Thermometer 0-200°C



**BE400P244**

|         |   |           |
|---------|---|-----------|
|         |   |           |
| 0.02 kg | 1 | BE400P244 |

Radiator cap tester for cooling system



**BE400P2403**

|         |   |            |
|---------|---|------------|
|         |   |            |
| 43.5 mm | 1 | BE400P2403 |

Adaptor for testing the cooling system



**BE400P2406**

|          |   |            |
|----------|---|------------|
|          |   |            |
| 0.065 kg | 1 | BE400P2406 |

Radiator cap tester for cooling system



**BE400P2401**

|       |   |            |
|-------|---|------------|
|       |   |            |
| 65 mm | 1 | BE400P2401 |

Adaptor for testing the cooling system



**BE400P2404**

|          |   |            |
|----------|---|------------|
|          |   |            |
| 0.055 kg | 1 | BE400P2404 |

Adaptor for testing the cooling system



**BE400P2407**

|          |   |            |
|----------|---|------------|
|          |   |            |
| 0.065 kg | 1 | BE400P2407 |



Adaptor for testing the cooling system



**BE400P2408**



0.075 kg



1 BE400P2408

Adaptor for testing the cooling system



**BE400P2411**



0.11 kg



1 BE400P2411

Adaptor for testing the cooling system



**BE400P2414**



0.11 kg



1 BE400P2414

Adaptor for testing the cooling system



**BE400P2409**



0.11 kg



1 BE400P2409

Adaptor for testing the cooling system



**BE400P2412**



0.085 kg



1 BE400P2412

Adaptor for testing the cooling system



**BE400P2415**



0.075 kg



1 BE400P2415

Adaptor for testing the cooling system



**BE400P2410**



0.085 kg



1 BE400P2410

Adaptor for testing the cooling system



**BE400P2413**



0.065 kg



1 BE400P2413

Adaptor for testing the cooling system



**BE400P2416**



0.065 kg



1 BE400P2416



Adaptor for testing the cooling system



**BE400P2417**

|         |   |            |
|---------|---|------------|
|         |   |            |
| 0.11 kg | 1 | BE400P2417 |

Adaptor for testing the cooling system



**BE400P2418**

|          |   |            |
|----------|---|------------|
|          |   |            |
| 0.045 kg | 1 | BE400P2418 |

Adaptor for testing the cooling system



**BE400P2419**

|          |   |            |
|----------|---|------------|
|          |   |            |
| 0.075 kg | 1 | BE400P2419 |

Plastic wrench for radiator cap



**BE400P2420**

|          |   |            |
|----------|---|------------|
|          |   |            |
| 0.005 kg | 1 | BE400P2420 |

Cooling system purging and filling set



**BE410**

|                   |   |        |
|-------------------|---|--------|
|                   |   |        |
| 80 x 300 x 375 mm | 4 | BE410  |
| 45 x 45 x 105 mm  | 1 | BE4101 |

Gasket joints separator set



**BE700**

|                  |   |           |
|------------------|---|-----------|
|                  |   |           |
| 90 x 200 x 43 mm | 1 | BE700     |
|                  | 1 | BE700BP2  |
|                  | 1 | BE700SP15 |

10 mm bit set



**BE5032**

|                   |   |        |
|-------------------|---|--------|
|                   |   |        |
| 65 x 225 x 225 mm | 1 | BE5032 |

|   |  |  |
|---|--|--|
| BE5049M5, BE5049M6, BE5049M8, BE5049M10, BE5049M12, BE5032M14                                     |  |  |
| BE5049T20, BE5049T25, BE5049T27, BE5049T30, BE5049T40, BE5049T45, BE5049T50, BE5049T55, BE5049T60 |  |  |
| BE5049H5, BE5049H6, BE5049H8, BE5049H10, BE5049H12, BE5032H14                                     |  |  |
| BE5032SQ8, BE5032SQ10   |  |  |
| BE5049H6L, BE5049H8L, BE5032H10EL   |  |  |
| BE5049T45L, BE5032T55EL   |  |  |
| BE5049M8L, BE5049M10L, BE5049M12L   |  |  |
| BE504901  |  |  |

Bit for Robertson Metric Head Screws, 10 mm



**BE5032SQ**



|        |       |   |            |
|--------|-------|---|------------|
|        |       |   |            |
| #8 mm  | 30 mm | 1 | BE5032SQ8  |
| #10 mm | 30 mm | 1 | BE5032SQ10 |

1/2" socket drivers with Tamper Torx bits





**BE510125-BE510160**

|      |        |   |          |
|------|--------|---|----------|
|      |        |   |          |
| TR25 | 100 mm | 1 | BE510125 |
| TR27 | 100 mm | 1 | BE510127 |
| TR30 | 100 mm | 1 | BE510130 |

|      |  |  |          |
|------|---|---|----------|
| TR40 | 100 mm  | 1   | BE510140 |
| TR45 | 100 mm  | 1   | BE510145 |
| TR50 | 100 mm  | 1   | BE510150 |
| TR55 | 100 mm  | 1   | BE510155 |
| TR60 | 100 mm  | 1   | BE510160 |



Adaptor set for disconnection of A/C hoses



|               |  |  |  |        |
|---------------|---|---|---|--------|
| <b>BAC007</b> | 240 mm  | 0.075 kg  | 1   | BAC007 |



Crankshaft and camshaft seal installation set



|  |  |            |
|--|---|------------|
| 80 x 270 x 375 mm  | 1   | BE5150P27  |
| 56 x 56 x 96 mm  | 1   | BE5150P271 |
| 80 x 80 x 195 mm   | 1   | BE5150P272 |
| 170 x 160 x 385 mm   | 1   | BE5150P273 |



Engine support bar



|  |  |  |              |
|---|---|---|--------------|
| <b>BH8AC1-500</b>   | 150 x 165 x 1800 mm   | 20.71 kg  | 1 BH8AC1-500 |

A/C repair tool set



|  |  |            |
|--|---|------------|
| <b>BE800P12</b>  | 43 x 90 x 200 mm  | 1 BE800P12 |

500 kg geared engine stand



|  |  |            |
|---|---|------------|
| <b>BH8AC2-500</b>   | 1   | BH8AC2-500 |



Angle hose clamp pliers 45°



|  |  |  |         |
|---|---|---|---------|
| <b>BE250</b>  | 190 mm  | 245 g   | 1 BE250 |

Hose clamp pliers



|  |  |  |           |
|---|---|---|-----------|
| <b>BE251A</b>   | 30 x 55 x 220 mm  | 228 g   | 12 BE251A |

EGR type hose clamp pliers



|  |  |         |
|---|---|---------|
| <b>BE253</b>  | 870 mm  | 1 BE253 |



Standard Space Saver & Hose Clamp Ratcheting Tool



**BE254A**

|          |   |        |  |
|----------|---|--------|--|
|          |   |        |  |
| 18-53 mm | 1 | BE254A |  |

Cable

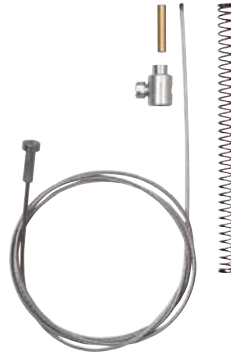

**BE2542**

|        |      |   |        |
|--------|------|---|--------|
|        |      |   |        |
| 630 mm | 20 g | 1 | BE2542 |

Oetiker™ Clamp Pliers



**BPOC15**

|        |    |        |
|--------|----|--------|
|        |    |        |
| 275 mm | 12 | BPOC15 |

Spare Cable for BE254A Pliers



**BE254A-01**

|        |       |   |           |
|--------|-------|---|-----------|
|        |       |   |           |
| 590 mm | 130 g | 1 | BE254A-01 |

Hose clamp metallic



**BE256M**

|                  |   |        |
|------------------|---|--------|
|                  |   |        |
| 40 x 45 x 310 mm | 1 | BE256M |

Hose clamp pliers set



**BE256P3**

|  |   |  |
|--|---|--|
|  |   |  |
| 40 x 93 x 330 mm<br>15 x 55 x 155 mm<br>20 x 45 x 185 mm<br>10 x 55 x 250 mm | 1 | BE256P3<br>BE256-155<br>BE256-178<br>BE256-250 |

Repair kit for BE254



**BE2541**

|       |   |        |
|-------|---|--------|
|       |   |        |
| 100 g | 1 | BE2541 |

Elastic hose clamp pliers



**BE258**

|          |        |   |       |
|----------|--------|---|-------|
|          |        |   |       |
| 12-55 mm | 285 mm | 1 | BE258 |

Slotted socket set



**BE5500**

|                   |    |        |
|-------------------|----|--------|
|                   |    |        |
| 10/11/12/14/17/19 | 25 | BE5500 |

Slotted Sockets



**BE5500-10/BE-5500-19**

|        |    |   |          |
|--------|----|---|----------|
|        |    |   |          |
| 3/8 in | 10 | 1 | BE550010 |
| 3/8 in | 11 | 1 | BE550011 |
| 3/8 in | 12 | 1 | BE550012 |
| 3/8 in | 14 | 1 | BE550014 |
| 1/2 in | 17 | 1 | BE550017 |
| 1/2 in | 19 | 1 | BE550019 |

Fuel line disconnecting pliers



**BE1FLD1/BE1FLD3**

|         |   |         |
|---------|---|---------|
|         |   |         |
| 10 mm   | 1 | BE1FLD1 |
| 8 mm    | 1 | BE1FLD2 |
| 18.5 mm | 1 | BE1FLD3 |

Seal and soft hose removal and picking tool set



**2633HD/S6**

|                   |             |
|-------------------|-------------|
|                   |             |
| 80 x 270 x 375 mm | 1 2633HD/S6 |
| 42 x 93 x 290 mm  | 1 2633HD1   |
| 30 x 85 x 215 mm  | 1 2633HD2   |
| 30 x 93 x 200 mm  | 1 2633HD3   |
| 20 x 87 x 165 mm  | 1 2633HD4   |
| 10 x 60 x 120 mm  | 1 2633HD5   |
| 10 x 10 x 155 mm  | 1 2633HD6   |

In-Line Fuel Filter Connection Pliers



**BE6FCP**

|        |        |    |        |
|--------|--------|----|--------|
|        |        |    |        |
| 104 mm | 218 mm | 30 | BE6FCP |

Fuel gauge puller



**BE1FTW**

|           |   |        |
|-----------|---|--------|
|           |   |        |
| 75-160 mm | 1 | BE1FTW |

T-Handle Set with Hex Metric Tips - 5 pcs



**BE1TH-S5**

|   |   |          |
|---|---|----------|
|   |   |          |
| 5 | 1 | BE1TH-S5 |

Fuel line disconnecting pliers set



**BE1FLDS**

|         |   |         |
|---------|---|---------|
|         |   |         |
| 8-10 mm | 1 | BE1FLDS |

Fuel Filter Wrench Ford 2.2TDCi



**BE1FFWF**

|                  |            |
|------------------|------------|
|                  |            |
| 5 x 142 x 169 mm | 12 BE1FFWF |

Set of 6 T-Bar Handles for Allen Hex Socket Head Screws 2.5, 3, 4, 5, 6 & 8 mm



**BE1TH-S6**

|   |    |          |
|---|----|----------|
|   |    |          |
| 6 | 30 | BE1TH-S6 |

BE1FLD2, BE1FLD3, BE1FLD1



BE1TH-4, BE1TH-8, BE1TH-2.5, BE1TH-3, BE1TH-6, BE1TH-5





T-bar handle for Allen - Hexagonal head screws



**BE1TH**

| mm     | g     | Icons | Part No.  |
|--------|-------|-------|-----------|
| 10 mm  | 385 g | 5     | BE1TH-10  |
| 12 mm  | 571 g | 5     | BE1TH-12  |
| 2 mm   | 15 g  | 10    | BE1TH-2   |
| 2.5 mm | 20 g  | 10    | BE1TH-2.5 |
| 3 mm   | 23 g  | 10    | BE1TH-3   |
| 3.5 mm | 23 g  | 10    | BE1TH-3.5 |
| 4 mm   | 60 g  | 10    | BE1TH-4   |
| 4.5 mm | 60 g  | 10    | BE1TH-4.5 |
| 5 mm   | 60 g  | 10    | BE1TH-5   |
| 6 mm   | 127 g | 10    | BE1TH-6   |
| 7 mm   | 205 g | 10    | BE1TH-7   |
| 8 mm   | 205 g | 10    | BE1TH-8   |
| 9 mm   | 385 g | 10    | BE1TH-9   |

T-bar handle with swivel socket 500 mm long



**BE1TS**

| mm    | g     | Icons | Part No. |
|-------|-------|-------|----------|
| 10 mm | 485 g | 10    | BE1TS-10 |
| 11 mm | 485 g | 10    | BE1TS-11 |
| 12 mm | 475 g | 10    | BE1TS-12 |
| 13 mm | 485 g | 10    | BE1TS-13 |
| 14 mm | 485 g | 10    | BE1TS-14 |
| 15 mm | 485 g | 10    | BE1TS-15 |
| 16 mm | 495 g | 10    | BE1TS-16 |
| 17 mm | 495 g | 10    | BE1TS-17 |
| 18 mm | 510 g | 10    | BE1TS-18 |
| 19 mm | 495 g | 10    | BE1TS-19 |
| 20 mm | 730 g | 8     | BE1TS-20 |
| 21 mm | 765 g | 8     | BE1TS-21 |
| 22 mm | 745 g | 8     | BE1TS-22 |
| 24 mm | 745 g | 8     | BE1TS-24 |
| 6 mm  | 475 g | 10    | BE1TS-6  |
| 7 mm  | 475 g | 10    | BE1TS-7  |
| 8 mm  | 485 g | 10    | BE1TS-8  |
| 9 mm  | 475 g | 10    | BE1TS-9  |

Set of 7 T-Bar Handles with Swivel Sockets 7, 8, 10, 12, 13, 14 & 17 mm 500 mm long



**BE1TS-S7**

| Quantity | Part No.   |
|----------|------------|
| 7        | 1 BE1TS-S7 |

BE1TS-17, BE1TS-13, BE1TS-14, BE1TS-12, BE1TS-7, BE1TS-8, BE1TS-10

T handle bar with rotating aluminium holder



**1945W**

| Size   | Length (mm) | Quantity | Part No. |
|--------|-------------|----------|----------|
| 1/2 in | 311 mm      | 6        | 1945W12  |
| 1/4 in | 311 mm      | 8        | 1945W14  |
| 3/8 in | 311 mm      | 6        | 1945W38  |

Bit set 49 pcs with Torx tamper bits



**BE5049**

| Dimensions        | Weight  | Quantity | Part No. |
|-------------------|---------|----------|----------|
| 55 x 190 x 320 mm | 3.56 kg | 5        | BE5049   |

1/2" adaptor for 10 mm bits



**BE504901**

| Size  | Length (mm) | Quantity | Part No. |
|-------|-------------|----------|----------|
| 10 mm | 36 mm       | 1        | BE504901 |

Bit for Hexagon Metric Head Screws, 10 mm



**BE5049H**

| Size  | Length (mm) | Quantity | Part No.  |
|-------|-------------|----------|-----------|
| 4 mm  | 30 mm       | 1        | BE5049H4  |
| 5 mm  | 30 mm       | 1        | BE5049H5  |
| 6 mm  | 30 mm       | 1        | BE5049H6  |
| 7 mm  | 30 mm       | 1        | BE5049H7  |
| 8 mm  | 30 mm       | 1        | BE5049H8  |
| 10 mm | 30 mm       | 1        | BE5049H10 |
| 12 mm | 30 mm       | 1        | BE5049H12 |
| 14 mm | 30 mm       | 1        | BE5032H14 |

Bit for XZN Head Screws, 10 mm



**BE5049M**

|     | L     |   |           |
|-----|-------|---|-----------|
| M5  | 30 mm | 1 | BE5049M5  |
| M6  | 30 mm | 1 | BE5049M6  |
| M8  | 30 mm | 1 | BE5049M8  |
| M10 | 30 mm | 1 | BE5049M10 |
| M12 | 30 mm | 1 | BE5049M12 |
| M14 | 30 mm | 1 | BE5032M14 |

Bit for Torx® Head Screws, 10 mm



**BE5049T**

|     | L     |   |           |
|-----|-------|---|-----------|
| T20 | 30 mm | 1 | BE5049T20 |
| T25 | 30 mm | 1 | BE5049T25 |
| T27 | 30 mm | 1 | BE5049T27 |
| T30 | 30 mm | 1 | BE5049T30 |
| T40 | 30 mm | 1 | BE5049T40 |
| T45 | 30 mm | 1 | BE5049T45 |
| T50 | 30 mm | 1 | BE5049T50 |
| T55 | 30 mm | 1 | BE5049T55 |
| T60 | 30 mm | 1 | BE5049T60 |

Bit for Torx® Tamper Head Screws, 10 mm



**BE5049T\_H**

|      | L     |   |            |
|------|-------|---|------------|
| TR20 | 30 mm | 1 | BE5049T20H |
| TR25 | 30 mm | 1 | BE5049T25H |
| TR27 | 30 mm | 1 | BE5049T27H |
| TR30 | 30 mm | 1 | BE5049T30H |
| TR40 | 30 mm | 1 | BE5049T40H |
| TR45 | 30 mm | 1 | BE5049T45H |
| TR50 | 30 mm | 1 | BE5049T50H |

|      | L     |   |            |
|------|-------|---|------------|
| TR55 | 30 mm | 1 | BE5049T55H |
| TR60 | 30 mm | 1 | BE5049T60H |

Torx® Tamper 1/2" socket with bit, suitable for engines



**BE5101**

| 65 x 225 x 225 mm |  | 1 | BE5101 |
|-------------------|--|---|--------|

| BE510150, BE510145, BE510160, BE510155, BE510127, BE510125, BE510140, BE510130 |  |  |  |
|--|--|--|--|

Engine oil pressure tester set



**BE5200**

| 85 x 355 x 445 mm |  | 1 | BE5200   |
|-------------------|--|---|----------|
| 25 x 105 x 195 mm |  | 1 | BE530001 |
|                   |  | 1 | BE52001  |
|                   |  | 1 | BE52002  |
|                   |  | 1 | BE52003  |

3/8" adaptor for 10 mm bits



**BE504902**

|       | L     |   |          |
|-------|-------|---|----------|
| 10 mm | 28 mm | 1 | BE504902 |

Bit for Hexagon Metric Head Screws, 10 mm



**BE5049H\_L**

|       | L      |   |             |
|-------|--------|---|-------------|
| 4 mm  | 75 mm  | 1 | BE5049H4L   |
| 5 mm  | 75 mm  | 1 | BE5049H5L   |
| 6 mm  | 75 mm  | 1 | BE5049H6L   |
| 7 mm  | 75 mm  | 1 | BE5049H7L   |
| 8 mm  | 75 mm  | 1 | BE5049H8L   |
| 10 mm | 75 mm  | 1 | BE5049H10L  |
| 10 mm | 115 mm | 1 | BE5032H10EL |
| 12 mm | 75 mm  | 1 | BE5049H12L  |

Bit for XZN Head Screws, 10 mm



**BE5049M\_L**

|     | L     |   |            |
|-----|-------|---|------------|
| M5  | 75 mm | 1 | BE5049M5L  |
| M6  | 75 mm | 1 | BE5049M6L  |
| M8  | 75 mm | 1 | BE5049M8L  |
| M10 | 75 mm | 1 | BE5049M10L |
| M12 | 75 mm | 1 | BE5049M12L |



Bit set 49 pcs with regular Torx bits



**BE5049t**

|                   |         |   |         |
|-------------------|---------|---|---------|
|                   |         |   |         |
| 55 x 190 x 320 mm | 3.54 kg | 1 | BE5049T |

Bit for Torx® Tamper Head Screws, 10 mm



**BE5049T\_HL**

|      |        |   |              |
|------|--------|---|--------------|
|      |        |   |              |
| TR20 | 75 mm  | 1 | BE5049T20HL  |
| TR25 | 75 mm  | 1 | BE5049T25HL  |
| TR27 | 75 mm  | 1 | BE5049T27HL  |
| TR30 | 75 mm  | 1 | BE5049T30HL  |
| TR40 | 75 mm  | 1 | BE5049T40HL  |
| TR45 | 75 mm  | 1 | BE5049T45HL  |
| TR50 | 75 mm  | 1 | BE5049T50HL  |
| TR55 | 75 mm  | 1 | BE5049T55HL  |
| TR60 | 75 mm  | 1 | BE5049T60HL  |
| TR70 | 100 mm | 1 | BE5049T70HL  |
| TR80 | 70 mm  | 1 | BE5049T80HL  |
| TR30 | 200 mm | 1 | BE5049T30HXL |
| TR40 | 200 mm | 1 | BE5049T40HXL |
| TR45 | 200 mm | 1 | BE5049T45HXL |

Bit for Torx® Head Screws, 10 mm

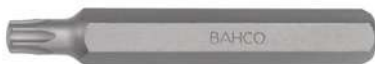

**BE5049T\_L**

|     |       |   |            |
|-----|-------|---|------------|
|     |       |   |            |
| T20 | 75 mm | 1 | BE5049T20L |
| T25 | 75 mm | 1 | BE5049T25L |
| T27 | 75 mm | 1 | BE5049T27L |
| T30 | 75 mm | 1 | BE5049T30L |

|     |        |   |             |
|-----|--------|---|-------------|
|     |        |   |             |
| T40 | 75 mm  | 1 | BE5049T40L  |
| T45 | 75 mm  | 1 | BE5049T45L  |
| T50 | 75 mm  | 1 | BE5049T50L  |
| T55 | 75 mm  | 1 | BE5049T55L  |
| T55 | 115 mm | 1 | BE5032T55EL |

## EXHAUST TOOLS

Exhaust Fume Extractor



**BUCPE**

|         |                     |   |         |
|---------|---------------------|---|---------|
|         |                     |   |         |
| 5000 mm | 1263 x 306 x 300 mm | 1 | BUCPE   |
| 105 mm  | 15 x 105 x 105 mm   | 1 | BUCPEF1 |
| 121 mm  | 60 x 121 x 121 mm   | 1 | BUCPEF  |

Tube extension for BUCPE



**BUCPE3SH**

|         |         |   |          |
|---------|---------|---|----------|
|         |         |   |          |
| 3000 mm | 63,5 mm | 1 | BUCPE3SH |

A dual exhaust pipe for BUCPE



**BUCPE3SDH**

|                     |         |   |           |
|---------------------|---------|---|-----------|
|                     |         |   |           |
| 420 x 530 x 3000 mm | 3000 mm | 1 | BUCPE3SDH |

1/2" Lambda service socket



**7812**

|       |       |     |      |
|-------|-------|-----|------|
|       |       |     |      |
| 22 mm | 78 mm | 100 | 7812 |

Exhaust clamp pliers



**BUC50**

|       |        |   |       |
|-------|--------|---|-------|
|       |        |   |       |
| 65 mm | 305 mm | 1 | BUC50 |

Universal exhaust removal tool



**BUC110**

|        |                  |   |        |
|--------|------------------|---|--------|
|        |                  |   |        |
| 360 mm | 50 x 65 x 360 mm | 1 | BUC110 |

Oil & Fuel Filter Remover



**BE60FW**

|           |                  |   |        |
|-----------|------------------|---|--------|
|           |                  |   |        |
| 57-120 mm | 18 x 95 x 325 mm | 5 | BE60FW |

Oil filter chain wrench



**BE64520/BE64350**

|        |           |   |           |
|--------|-----------|---|-----------|
|        |           |   |           |
| 350 mm | 60-105 mm | 1 | BE64350   |
| 350 mm | 60-105 mm | 1 | BE64350CH |
| 520 mm | 60-160 mm | 1 | BE64520   |
| 520 mm | 60-160 mm | 1 | BE64520CH |

Universal exhaust puller



**BUC100**

|          |        |   |        |
|----------|--------|---|--------|
|          |        |   |        |
| 34-54 mm | 320 mm | 1 | BUC100 |

Oil filter strap wrench



**BE611**

|            |                  |     |           |
|------------|------------------|-----|-----------|
|            |                  |     |           |
| 65-105 mm  | 25 x 55 x 210 mm | 12  | BE61110   |
| 65-105 mm  | 1 x 12 x 382 mm  | 100 | BE61110-1 |
| 100-155 mm | 37 x 75 x 275 mm | 12  | BE61155   |
| 100-155 mm | 1 x 12 x 529 mm  | 1   | BE61155-1 |

Rubber belt wrench



**BE66152A**

|        |                   |   |          |
|--------|-------------------|---|----------|
|        |                   |   |          |
| 150 mm | 95 x 170 x 220 mm | 6 | BE66152A |

**OIL SERVICE TOOLS & EQUIPMENT**

Fuel Filter Cover Wrench



**BE60F108**

|        |        |    |          |
|--------|--------|----|----------|
|        |        |    |          |
| 3/8 in | 108 mm | 50 | BE60F108 |

Oil filter strap wrench with rubber handle



**BE62**

|            |                    |    |         |
|------------|--------------------|----|---------|
|            |                    |    |         |
| 65-105 mm  | 42.5 x 57 x 249 mm | 10 | BE62110 |
| 110-155 mm | 42.5 x 85 x 314 mm | 10 | BE62155 |

3-jaw oil filter wrench



**BE65F65120**

|        |           |    |            |
|--------|-----------|----|------------|
|        |           |    |            |
| 3/8 in | 65-120 mm | 12 | BE65F65120 |



## Magnetic 3-jaw oil filter wrenches



### BE65R

| Icon 1     | Icon 2     | Icon 3 | Icon 4      |
|------------|------------|--------|-------------|
| 3/8-1/2 in | 65-120 mm  | 1      | BE65R65120  |
| 3/8-1/2 in | 80-119 mm  | 1      | BE65R80120  |
| 1/2 in     | 105-160 mm | 1      | BE65R106160 |

## Oil filter cup set



### BE630

| Icon 1            | Icon 2 | Icon 3 | Icon 4 |
|-------------------|--------|--------|--------|
| 87 x 505 x 610 mm |        | 3      | BE630  |

## Individual filter cups



### BE630 Parts

| Icon 1   | Icon 2                         | Icon 3 | Icon 4       |
|----------|--------------------------------|--------|--------------|
| 66 mm    | Fiat, Renault                  | 1      | BE630666F    |
| 64 mm    | Daihatsu, Fiat, Nissan, Toyota | 12     | BE6306514F   |
| 65-66 mm | Daihatsu, Toyota               | 12     | BE630656714F |
| 66 mm    | Ford, Mazda, Subaru            | 1      | BE6306814F   |

| Icon 1   | Icon 2  | Icon 3 | Icon 4       |
|----------|---|--------|--------------|
| 73 mm    | Alfa Romeo, Lexus, Toyota   | 1      | BE6307314F   |
| 74 mm    | Audi, Chrysler, GM, Rover   | 1      | BE6307415F   |
| 74-76 mm | Audi, Ford, Mercedes Benz, Opel, VW   | 12     | BE630747615F |
| 74-75 mm | Audi, Ford, Isuzu, Mercedes Benz, Opel, VW                                      | 1      | BE630757715F |
| 76 mm    | Fiat, Mercedes Benz, Renault  | 12     | BE6307612F   |
| 74 mm    | Audi, BMW, Mercedes Benz, Opel, Porsche, VW                                     | 12     | BE6307614F   |
| 74 mm    | Ford  | 1      | BE6307630F   |
| 74 mm    | Fiat, Lancia  | 1      | BE630768F    |
| 78 mm    | Ford, Honda, Nissan, Toyota   | 12     | BE6307815F   |
| 80 mm    | Honda, Isuzu, Mazda, Nissan, Opel, Subaru, Toyota                               | 1      | BE6308015F   |
| 80-82 mm | Acura, Honda, Mazda, Nissan, Subaru, Toyota                                     | 1      | BE630808215F |
| 86 mm    | Volvo   | 1      | BE6308616F   |
| 86 mm    | Audi, Citroen, Peugeot, Renault, VW   | 1      | BE6308618F   |
| 89 mm    | Honda, Isuzu, Mitsubishi  | 12     | BE6309015F   |
| 92 mm    | Fiat, Lancia  | 1      | BE6309210F   |
| 92 mm    | Audi, Ford, Honda, Mazda, Mitsubishi, Nissan, Opel, Porsche, Renault, Volvo, VW | 1      | BE6309315F   |
| 93 mm    | Ford  | 1      | BE6309336F   |
| 93 mm    | Audi, VW  | 1      | BE6309345F   |
| 95 mm    | Alfa Romeo, Chrysler, Ford, Toyota  | 1      | BE6309515F   |
| 96 mm    | Audi, Renault, VW   | 1      | BE6309618F   |
| 101 mm   | Isuzu, Mitsubishi   | 25     | BE63010015F  |
| 24 mm    | BMW   | 50     | BE630246F    |
| 106 mm   | Fiat, MAN, Scania   | 1      | BE63010615F  |
| 27 mm    | Mercedes Benz   | 50     | BE630276F    |
| 107 mm   | Volvo   | 1      | BE63010815F  |
| 32 mm    | GM, Mercedes Benz, Opel, Saab   | 50     | BE630326F    |
| 108 mm   | Renault   | 1      | BE63010818F  |
| 36 mm    | BMW, Ford, Mercedes Benz, Opel, Rover, VW                                       | 100    | BE630366F    |
| 38 mm    | BMW, Opel, Volvo  | 50     | BE630386F    |
| 66.5 mm  | Daihatsu, Toyota  | 25     | BE63066514F  |

## 27 mm oil filter wrench for Ford and PSA Group



### BE6302712F

| Icon 1 | Icon 2 | Icon 3 | Icon 4     |
|--------|--------|--------|------------|
| 1/2 in | 27 mm  | 5      | BE6302712F |

## Oil Filter Wrench Toyota, Lexus, Subaru, Daihatsu with 4 Cylinders (1.8 to 2.0 litre)



### BE63064514F1

| Icon 1   | Icon 2  | Icon 3 | Icon 4       |
|--|---------|--------|--------------|
| Toyota, Lexus, Subaru, Daihatsu 4 cylinders (1.8-2.0l) | 64.5 mm | 1      | BE63064514F1 |

## Oil Filter Wrench Toyota, Lexus, Subaru, Daihatsu with 4, 6 or 8 Cylinders (2.5 to 5.7 litre)



### BE63064514F2

| Icon 1  | Icon 2   | Icon 3 | Icon 4       |
|---------|--|--------|--------------|
| 64.5 mm | Toyota, Lexus, Subaru, Daihatsu 4, 6, 8 cylinders (2.5-5.7L) | 1      | BE63064514F2 |



Oil Filter Cup 74 mm 14 Flutes



**BE6307414F**

|    |   |    |            |
|----|---|----|------------|
|    |   |    |            |
| 14 | 1 | 10 | BE6307414F |

Oil drain plug socket set



**BE6217**

|  |                   |   |        |
|--|-------------------|---|--------|
|  |                   |   |        |
|  | 55 x 105 x 220 mm | 1 | BE6217 |

Oil drain plug restorer set



**BOD10P64**

|  |                   |   |          |
|--|-------------------|---|----------|
|  |                   |   |          |
|  | 68 x 225 x 280 mm | 8 | BOD10P64 |

Carter wrenches



**BE68**

|           |        |    |         |
|-----------|--------|----|---------|
|           |        |    |         |
| 8 in      | 265 mm | 12 | BE6810Z |
| 8 in      | 235 mm | 1  | BE68    |
| 8 x 10 mm | 270 mm | 1  | BE6810  |

3/8" Oil Plug Socket



**BE621701-BE621717**

|     |         |   |          |
|-----|---------|---|----------|
|     |         |   |          |
| 6   | 8 mm    | 1 | BE621701 |
| 6   | 9 mm    | 1 | BE621702 |
| 6   | 10 mm   | 1 | BE621703 |
| 6   | 12 mm   | 1 | BE621704 |
| 6   | 13 mm   | 1 | BE621705 |
| 6   | 14 mm   | 1 | BE621706 |
| 6   | 17 mm   | 1 | BE621707 |
| 4   | 8 mm    | 1 | BE621708 |
| 4   | 9.5 mm  | 1 | BE621709 |
| 4   | 10 mm   | 1 | BE621710 |
| 4   | 10.5 mm | 1 | BE621711 |
| 4   | 11 mm   | 1 | BE621712 |
| 4   | 12 mm   | 1 | BE621713 |
| 4   | 13.1 mm | 1 | BE621714 |
| 4   | 10 mm   | 1 | BE621715 |
| 3   | 10 mm   | 1 | BE621716 |
| xZN | M16 mm  | 1 | BE621717 |

1/4" Oil sump plug removal bit for VAG engine 2 litre 4 cylinders



**BE6701VAG**

|                  |         |   |           |
|------------------|---------|---|-----------|
|                  |         |   |           |
| 10 x 50 x 125 mm | 0.02 kg | 1 | BE6701VAG |

Mini oil drain plug restorer sets



**BOD10**

|                  |   |        |  |
|------------------|---|--------|--|
|                  |   |        |  |
| 34 x 93 x 105 mm | 1 | BOD101 |  |
| 35 x 95 x 105 mm | 1 | BOD102 |  |
| 33 x 93 x 105 mm | 1 | BOD103 |  |
| 33 x 93 x 105 mm | 1 | BOD104 |  |
| 33 x 93 x 105 mm | 1 | BOD105 |  |
| 95 x 105 x 35 mm | 1 | BOD106 |  |

Oil drain plug and washer set



**BOD10XNWS**

|          |   |           |
|----------|---|-----------|
|          |   |           |
| M13x1.25 | 1 | BOD101NWS |
| M13x1.5  | 1 | BOD102NWS |
| M15x1.5  | 1 | BOD103NWS |
| M17x1.5  | 1 | BOD104NWS |
| M20x1.5  | 1 | BOD105NWS |
| M22x1.5  | 1 | BOD106NWS |



2 in 1 oil drainer with tank capacity 90L and inspection chamber



**BOD8903A**



1700 x 419 x 608 mm

1 BOD8903A

2 in 1 oil drainer with tank capacity 90L



**BOD8902**



1000 x 413 x 632 mm 38 kg

1 BOD8902

Gravity oil drainer with tank capacity 90L



**BOD8901**



1000 x 413 x 630 mm 32 kg

1 BOD8901

Extension funnel for oil drainers



**BOD8901AC1**



620 x 620 x 150 mm

1 BOD8901AC1

Automatic transmission fluid refiller



**BOD6080P12**



595 x 255 x 330 mm

1 BOD6080P12

Adaptor for BOD6080P12 set



**BOD6080P12-01**



35 g

1 BOD6080P12-01

Adaptor for BOD6080P12 set



**BOD6080P12-02**



55 g

1 BOD6080P12-02

Adaptor for BOD6080P12 set



**BOD6080P12-03**



45 g

1 BOD6080P12-03

Adaptor for BOD6080P12 set



**BOD6080P12-04**



6 g

1 BOD6080P12-04

Adaptor for BOD6080P12 set



**BOD6080P12-05**

|      |   |               |
|------|---|---------------|
|      |   |               |
| 25 g | 1 | BOD6080P12-05 |

Adaptor for BOD6080P12 set



**BOD6080P12-06**

|      |   |               |
|------|---|---------------|
|      |   |               |
| 25 g | 1 | BOD6080P12-06 |

Adaptor for BOD6080P12 set



**BOD6080P12-07**

|      |   |               |
|------|---|---------------|
|      |   |               |
| 45 g | 1 | BOD6080P12-07 |

Adaptor for BOD6080P12 set



**BOD6080P12-08**

|      |   |               |
|------|---|---------------|
|      |   |               |
| 45 g | 1 | BOD6080P12-08 |

Adaptor for BOD6080P12 set



**BOD6080P12-09**

|      |   |               |
|------|---|---------------|
|      |   |               |
| 15 g | 1 | BOD6080P12-09 |

Adaptor for BOD6080P12 set



**BOD6080P12-10**

|      |   |               |
|------|---|---------------|
|      |   |               |
| 85 g | 1 | BOD6080P12-10 |

Adaptor for BOD6080P12 set



**BOD6080P12-11**

|       |   |               |
|-------|---|---------------|
|       |   |               |
| 105 g | 1 | BOD6080P12-11 |

Oil cans



**BOD4200/BOD4500**

|      |                   |   |         |
|------|-------------------|---|---------|
|      |                   |   |         |
| 0.2l | 158 x 86 x 128 mm | 1 | BOD4200 |
| 0.5l | 158 x 86 x 128 mm | 1 | BOD4500 |

Oil funnel



**BOD301200**

|                    |   |           |
|--------------------|---|-----------|
|                    |   |           |
| 225 x 165 x 165 mm | 1 | BOD301200 |

Oil drain tank



**BOD2008**

|     |                    |   |         |
|-----|--------------------|---|---------|
|     |                    |   |         |
| 8 l | 115 x 325 x 590 mm | 1 | BOD2008 |

Oil drain pan



**BOD1016**

|      |                    |   |         |
|------|--------------------|---|---------|
|      |                    |   |         |
| 16 l | 170 x 450 x 570 mm | 1 | BOD1016 |



For tapping damaged oil plug thread slightly oversize, then fitting a new drain plug and washer



**BOD10XT**

| Length (mm) | Thread   | Quantity | Part No. |
|-------------|----------|----------|----------|
| 92 mm       | M13x1.25 | 1        | BOD101T  |
| 70 mm       | M13x1.5  | 1        | BOD102T  |
| 70 mm       | M15x1.5  | 1        | BOD103T  |
| 70 mm       | M17x1.5  | 1        | BOD104T  |
| 70 mm       | M20x1.5  | 1        | BOD105T  |
| 70 mm       | M22x1.5  | 1        | BOD106T  |

**Lever Action Barrel Pump**



**BOD60**

|                   |   |       |
|-------------------|---|-------|
| 875 x 57 x 245 mm | 1 | BOD60 |
|-------------------|---|-------|

**Grease flex hoses**



**BOD54-1 / -2**

|        |         |   |         |
|--------|---------|---|---------|
| 4.1 mm | 10.8 mm | 1 | BOD54-1 |
| 4.1 mm | 10.8 mm | 1 | BOD54-2 |

**2L Can with Flexible Spout**



**BOD2FS**

|    |                    |    |        |
|----|--------------------|----|--------|
| 21 | 330 x 130 x 380 mm | 20 | BOD2FS |
|----|--------------------|----|--------|

**Heavy duty cartridge grease pump**



**BOD5HD400**

|                   |   |           |
|-------------------|---|-----------|
| 60 x 115 x 360 mm | 1 | BOD5HD400 |
|-------------------|---|-----------|

**Grease coupler**



**BOD54-3**

|       |   |         |
|-------|---|---------|
| 37 mm | 1 | BOD54-3 |
|-------|---|---------|

**Rotary barrel pump**



**BOD70**

|                     |   |       |
|---------------------|---|-------|
| 230 x 250 x 1330 mm | 1 | BOD70 |
|---------------------|---|-------|

**Cartridge grease pump**



**BOD5400/BOD5450**

|                   |   |         |
|-------------------|---|---------|
| 55 x 120 x 390 mm | 1 | BOD5400 |
| 65 x 125 x 385 mm | 1 | BOD5450 |

**BRAKE SYSTEM TOOLS & EQUIPMENT**

**Brake fluid tester pen**



**BBR100**

|                  |   |        |
|------------------|---|--------|
| 20 x 20 x 150 mm | 1 | BBR100 |
|------------------|---|--------|

Brake fluid tester moisture check



**BBR110**



35 x 65 x 160 mm

1 BBR110

Brake Nipple Spanners



**BBR501011-50121314**



10 / 11 mm  
12 / 14 mm

3/8 in  
3/8 in

50 BBR501011  
50 BBR50121314

Air brake system bleeder



**BBR350**



1/4" in 300 x 125 x 125 mm

1 BBR350

12V Electrical Brake Bleeder



**BBRBB12**



895 x 390 x 395 mm 14.6 kg

1 BBRBB12

Brake bleeder master cylinder cap adapter kit



Brake Bleeder Master Cylinder Cap Adapter Kit Contents



**BBRAS14-01/BBRAS14-14**



|        |   |   |            |
|--------|---|---|------------|
| PN5 in | Universal   | 1 | BBRAS14-01 |
| PN5 in | Honda   | 1 | BBRAS14-02 |
| PN5 in | Honda Accord  | 1 | BBRAS14-03 |
| PN5 in | Universal   | 1 | BBRAS14-04 |
| PN5 in | Chrysler, Jeep, Plymouth  | 1 | BBRAS14-05 |
| PN5 in | Chrysler, Jeep, Plymouth, Dodge   | 1 | BBRAS14-06 |
| PN5 in | Nissan  | 1 | BBRAS14-07 |
| PN5 in | Alfa Romeo, Fiat, Peugeot, Citroën, Audi, BMW, Jaguar, Land Rover, Mercedes, Porsche, Renault, Saab, VW, Volvo, Chrysler, Daewoo, Ford, Kia, Mazda, Mini, etc | 1 | BBRAS14-08 |
| PN5 in | Hyundai, Mitsubishi, Nissan, Subaru, Chrysler, Dodge, Ford, etc.  | 1 | BBRAS14-09 |
| PN5 in | GM Models and Mazda   | 1 | BBRAS14-10 |
| PN5 in | Toyota and Lexus  | 1 | BBRAS14-11 |
| N/A in | Holder for universal adaptor  | 1 | BBRAS14-12 |
| N/A in | Syringe   | 1 | BBRAS14-13 |
| N/A in | Hooks, chains and roulettes for BBRAS14-01 and BBRAS14-04   | 1 | BBRAS14-14 |



**BBRAS14**



PN5 in 85 x 350 x 445 mm 4 BBRAS14

Brake pad thickness gauge



**BBRPTG1**



68 g 10 BBRPTG1





Micrometer with magnetic base



**1154**



230 x 50 x 75 mm

1 1154

1154-DG



1154-MB



Dial indicator



**1154-DG**



0-10 mm

0.01 mm

1 1154-DG

Magnetic base holder



**1154-MB**



70 x 96 x 297 mm 230 + 150 mm

1 1154-MB

Aluminium caliper



**BBR400**



6 x 89 x 120 mm

1 BBR400

Digital caliper for brake discs



**BBR420**



0-60 mm 35 x 104 x 176 mm

50 BBR420

Digital Brake Caliper

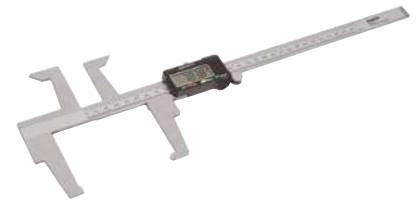

**BBR405**



460 mm

20 BBR405

Brake brush, steel



**783**



223 mm

1 783

Caliper for measuring brake disc and brake shoe diameters



**BBR410**



20 x 210 x 280 mm 0.610 kg

24 BBR410

Brake caliper wind-back air tool



**BBR320**



3/8 in

1/4" in

1 BBR320

Universal brake caliper tool set 50 pieces



**BBR300P50**

|                   |         |   |           |
|-------------------|---------|---|-----------|
|                   |         |   |           |
| 82 x 350 x 425 mm | 5.56 kg | 4 | BBR300P50 |

|     |       |   |            |
|-----|-------|---|------------|
|     |       |   |            |
| T30 | 78 mm | 1 | BBR203P930 |
| T40 | 78 mm | 1 | BBR203P940 |
| T45 | 78 mm | 1 | BBR203P945 |
| T50 | 78 mm | 1 | BBR203P950 |
| T55 | 78 mm | 1 | BBR203P955 |
| T60 | 78 mm | 1 | BBR203P960 |

XZN 1/2" impact socket bit set for brakes



**BBR201P6**

|                   |   |          |
|-------------------|---|----------|
|                   |   |          |
| 68 x 225 x 225 mm | 8 | BBR201P6 |

BBR201P67814, BBR201P67816,  
BBR201P67818, BBR201P64018,  
BBR201P64014, BBR201P64016

1/2 impact socket driver XZN



**BBR201P64014-BB201P67818**

|     |       |   |              |
|-----|-------|---|--------------|
|     |       |   |              |
| M14 | 40 mm | 1 | BBR201P64014 |
| M16 | 40 mm | 1 | BBR201P64016 |
| M18 | 40 mm | 1 | BBR201P64018 |
| M14 | 78 mm | 1 | BBR201P67814 |
| M16 | 78 mm | 1 | BBR201P67816 |
| M18 | 78 mm | 1 | BBR201P67818 |

1/2" impact socket drivers with Torx bits for brakes



**BBR203P920-BBR203P960**

|     |       |   |            |
|-----|-------|---|------------|
|     |       |   |            |
| T20 | 78 mm | 1 | BBR203P920 |
| T25 | 78 mm | 1 | BBR203P925 |
| T27 | 78 mm | 1 | BBR203P927 |

1/2" pentagon socket and bit set for hand brake



**BBR202P4**

|                  |   |            |
|------------------|---|------------|
|                  |   |            |
| 43 x 90 x 200 mm | 1 | BBR202P4   |
|                  | 1 | BBR202P410 |
|                  | 1 | BBR202P414 |
|                  | 1 | BBR202P419 |
|                  | 1 | BBR202P455 |

Shoe brake springs removal and installation set



**BBR210P3**

|                   |   |           |
|-------------------|---|-----------|
|                   |   |           |
| 80 x 270 x 375 mm | 1 | BBR210P3  |
| 25 x 59 x 182 mm  | 1 | BBRS210P  |
| 75 x 270 x 350 mm | 1 | BBRS210P2 |

Brake spring pliers with pivoting head



**BBR6135**

|        |   |         |
|--------|---|---------|
|        |   |         |
| 335 mm | 1 | BBR6135 |



### Brake spring pliers



#### BBR6131



210 mm



1 BBR6131

### Hand Brake Cable Pliers



#### BBR204



235 mm



21,9 mm



6 BBR204

### Brake Circuit Clamps



#### BBR150i



13.5 mm



10 x 52 x 165 mm



24 BBR150i

### Flaring Kit



#### BBRFKM1



141 x 115 x 195 mm



1551 g



12 BBRFKM1

## TRANSMISSION & WHEEL TOOLS

### Wheel wrenches



#### 29-B/BWXW1/BWXW2



17,19,21 mm

1/2 in

1 29-B

17,19,22 mm

1/2 in

1 BWXW1

24,27,32 mm

3/4 in

1 BWXW2

17, 19, 21, 22 mm

1 BWXW3

24, 27, 32, 38 mm

1 BWXW4

### 17, 19, 21, 22 and 24 mm impact wheel socket set



#### BWSS12P5



17, 19, 21,  
22, 24 mm

175 x 240 x 50 mm

1 BWSS12P5

BWSS12P319, BWSS12P317,  
BWSS12P524, BWSS12P522, BWS-  
S12P321



### Wheel socket sets



#### BWSS12P



1/2 in

17 mm

1 BWSS12P317

1/2 in

19 mm

1 BWSS12P319

1/2 in

21 mm

1 BWSS12P321

1/2 in

22 mm

1 BWSS12P522

1/2 in

24 mm

1 BWSS12P524

### 17, 19 and 21 mm impact wheel socket set



#### BWSS12P3



17, 19, 21 mm 45 x 125 x 145 mm

20 BWSS12P3

### 15 mm impact wheel socket



#### BWSMB15



15 mm

25 BWSMB15

BWSS12P317, BWSS12P319, BWS-  
S12P321



17 mm impact socket for Mercedes anti-theft wheel nut



**BWSMB17**

|       |  |   |         |
|-------|--|---|---------|
|       |  |   |         |
| 17 mm |  | 1 | BWSMB17 |

21 mm anti-theft impact socket for Hyundai and KIA



**BWSHK21**

|         |       |    |         |
|---------|-------|----|---------|
|         |       |    |         |
| 1/2" in | 21 mm | 25 | BWSHK21 |

17, 19 and 21 mm long reach impact wheel socket set



**BWSS12P3L**

|               |                   |  |   |           |
|---------------|-------------------|--|---|-----------|
|               |                   |  |   |           |
| 17, 19, 21 mm | 68 x 225 x 225 mm |  | 1 | BWSS12P3L |

BWSS12P317L, BWSS12P319L, BWSS12P321L

1/2" long reach impact wheel socket



**BWSS12PL**

|        |       |       |       |   |             |
|--------|-------|-------|-------|---|-------------|
|        |       |       |       |   |             |
| 1/2 in | 17 mm |       |       | 1 | BWSS12P317L |
| 1/2 in |       | 19 mm |       | 1 | BWSS12P319L |
| 1/2 in |       |       | 21 mm | 1 | BWSS12P321L |

Long twist socket set 1/2" 17, 19 and 21 mm



**BWTSP3L**

|                   |           |
|-------------------|-----------|
|                   |           |
| 68 x 225 x 150 mm | 1 BWTSP3L |

BWTSP317L, BWTSP319L, BWT-SP321L

Deep 1/2" Twist Sockets 150 mm long



**BWTSP317L-BWTSP321L**

|        |       |       |       |   |           |
|--------|-------|-------|-------|---|-----------|
|        |       |       |       |   |           |
| 1/2 in | 17 mm |       |       | 1 | BWTSP317L |
| 1/2 in |       | 19 mm |       | 1 | BWTSP319L |
| 1/2 in |       |       | 21 mm | 1 | BWTSP321L |

Twist socket set 1/2" 17, 19, 21, 22, 24 mm



**BWTSP6**

|                   |          |
|-------------------|----------|
|                   |          |
| 55 x 105 x 217 mm | 1 BWTSP6 |

BWTSP619, BWTSP617, BWTSP622, BWTSP621, BWTSP624

Deep Twist Sockets



**BWTSP617-BWTSP624**

|       |        |   |          |
|-------|--------|---|----------|
|       |        |   |          |
| 17 mm | 1/2 in | 1 | BWTSP617 |
| 19 mm | 1/2 in | 1 | BWTSP619 |
| 21 mm | 1/2 in | 1 | BWTSP621 |
| 22 mm | 1/2 in | 1 | BWTSP622 |
| 24 mm | 1/2 in | 1 | BWTSP624 |

Twist socket set



**BWTSP7**

|                   |          |
|-------------------|----------|
|                   |          |
| 52 x 117 x 207 mm | 1 BWTSP7 |

1/2": 22, 24, 27, 32 mm & 3/4": 36, 41 mm





Twist socket sets



**BWTSP16**

|                   |   |         |
|-------------------|---|---------|
|                   |   |         |
| 48 x 125 x 245 mm | 1 | BWTSP16 |

3/8": 8, 10, 11, 12, 13, 14, 16, 17, 18, 19 mm & 1/2": 21, 22, 24, 27 mm

Twist socket



**BWTSP**

|       |        |   |           |
|-------|--------|---|-----------|
|       |        |   |           |
| 8 mm  | 3/8 in | 1 | BWTSP1608 |
| 10 mm | 3/8 in | 1 | BWTSP1610 |
| 11 mm | 3/8 in | 1 | BWTSP1611 |
| 12 mm | 3/8 in | 1 | BWTSP1612 |
| 13 mm | 3/8 in | 1 | BWTSP1613 |
| 14 mm | 3/8 in | 1 | BWTSP1614 |
| 16 mm | 3/8 in | 1 | BWTSP1616 |
| 17 mm | 3/8 in | 1 | BWTSP1617 |
| 18 mm | 3/8 in | 1 | BWTSP1618 |
| 19 mm | 3/8 in | 1 | BWTSP1619 |
| 21 mm | 1/2 in | 1 | BWTSP1621 |
| 22 mm | 1/2 in | 1 | BWTSP1622 |
| 24 mm | 1/2 in | 1 | BWTSP1624 |
| 27 mm | 1/2 in | 1 | BWTSP1627 |
| 32 mm | 1/2 in | 1 | BWTSP732  |
| 36 mm | 3/4 in | 1 | BWTSP736  |
| 41 mm | 3/4 in | 1 | BWTSP741  |

Set of 5 torsion bars with 1/2" drive designed for tightening wheel nuts with an impact wrench without exceeding the recommended torque



**BWTB12P5**

|                   |         |   |          |
|-------------------|---------|---|----------|
|                   |         |   |          |
| 68 x 225 x 280 mm | 1.74 kg | 1 | BWTB12P5 |

BWTB12P90, BWTB12P100, BWTB12P110, BWTB12P120, BWTB12P135

Torsion bars with 1/2" drive designed for tightening wheel nuts with an impact wrench without exceeding the recommended torque



**BWTB1290-BWTB12P200**

|        |         |   |            |
|--------|---------|---|------------|
|        |         |   |            |
| 200 mm | 100 N·m | 1 | BWTB12P100 |
| 200 mm | 110 N·m | 1 | BWTB12P110 |
| 200 mm | 120 N·m | 1 | BWTB12P120 |
| 200 mm | 135 N·m | 1 | BWTB12P135 |
| 200 mm | 150 N·m | 1 | BWTB12P150 |
| 200 mm | 160 N·m | 1 | BWTB12P160 |
| 200 mm | 175 N·m | 1 | BWTB12P175 |
| 200 mm | 190 N·m | 1 | BWTB12P190 |
| 200 mm | 200 N·m | 1 | BWTB12P200 |
| 200 mm | 90 N·m  | 1 | BWTB12P90  |

1" impact torsion bars



**BZWTB**

|       |         |   |              |
|-------|---------|---|--------------|
|       |         |   |              |
| 32 mm | 450 N·m | 1 | BZWTB0132450 |
| 32 mm | 600 N·m | 1 | BZWTB0132600 |

Wheel bolt bag



**BWBB**

|          |                  |     |      |
|----------|------------------|-----|------|
|          |                  |     |      |
| 0.023 kg | 180 x 1 x 300 mm | 200 | BWBB |

Thread Tapping Set



**BWHTRS12**

|                   |        |    |          |
|-------------------|--------|----|----------|
|                   |        |    |          |
| 225 x 67 x 225 mm | 1350 g | 15 | BWHTRS12 |



Tyre lever



**38-8 - 38-24**

| Length (mm) | Quantity | Part Number |
|-------------|----------|-------------|
| 200 mm      | 5        | 38-8        |
| 300 mm      | 5        | 38-12       |
| 400 mm      | 5        | 38-16       |
| 500 mm      | 2        | 38-20       |
| 600 mm      | 1        | 38-24       |

Tyre lever, special bent form



**39-24**

| Length (mm) | Quantity | Part Number |
|-------------|----------|-------------|
| 605 mm      | 1        | 39-24       |

Digital tyre tread depth gauge



**BWTDG1**

| Length (mm) | Dimensions (mm)  | Quantity | Part Number |
|-------------|------------------|----------|-------------|
| 0 - 25 mm   | 30 x 76 x 156 mm | 50       | BWTDG1      |

Tyre levers



**38A**

| Length (mm) | Quantity | Part Number |
|-------------|----------|-------------|
| 200 mm      | 25       | 38A-08      |
| 240 mm      | 25       | 38A-10      |
| 304 mm      | 1        | 38A-12      |
| 382 mm      | 25       | 38A-15      |
| 537 mm      | 1        | 38A-21      |
| 655 mm      | 1        | 38A-26      |

Wheel Chocks



**BWC1**

| Dimensions (mm)  | Quantity | Part Number |
|------------------|----------|-------------|
| 75 x 77 x 110 mm | 25       | BWC1        |

Tyre pressure gauge



**BWTPG1**

| Dimensions (mm)  | Quantity | Part Number |
|------------------|----------|-------------|
| 20 x 90 x 394 mm | 10       | BWTPG1      |

Tyre lever for commercial vehicles and trucks



**38C**

| Length (mm) | Quantity | Part Number |
|-------------|----------|-------------|
| 645 mm      | 1        | 38C-26      |

Wheel balancing pliers



**BWP150**

| Dimensions (mm)  | Quantity | Part Number |
|------------------|----------|-------------|
| 20 x 87 x 255 mm | 1        | BWP150      |

Tire Pressure Monitoring System Maintenance Tool Set



**BWTPMSS9**

| Dimensions (mm)   | Weight (g) | Quantity | Part Number |
|-------------------|------------|----------|-------------|
| 68 x 225 x 225 mm | 1049 g     | 8        | BWTPMSS9    |



Tire valve core tool with 0.45 Nm max torque



**BWTVCTT355**

|          |             |   |            |
|----------|-------------|---|------------|
|          |             |   |            |
| 0.45 N·m | 0.33 lbf·ft | 1 | BWTVCTT355 |

1/2" impact socket with bihex profile



**BT15P524-BT15P536**

|        |       |   |          |
|--------|-------|---|----------|
|        |       |   |          |
| 1/2 in | 24 mm | 1 | BT15P524 |
| 1/2 in | 30 mm | 1 | BT15P530 |
| 1/2 in | 32 mm | 1 | BT15P532 |
| 1/2 in | 36 mm | 1 | BT15P536 |

Impact sockets BPW



**BHVISxxBPW**

|        |        |   |               |
|--------|--------|---|---------------|
|        |        |   |               |
| 3/4 in | 111 mm | 1 | BHVIS111BPW12 |
| 3/4 in | 80 mm  | 1 | BHVIS80BPW12  |
| 3/4 in | 95 mm  | 1 | BHVIS95BPW9   |

Tyre Nozzle Deflation Caps



**BWTPMSS4C**

|                  |      |    |           |
|------------------|------|----|-----------|
|                  |      |    |           |
| 27 x 59 x 108 mm | 60 g | 25 | BWTPMSS4C |

3/4" heavy vehicle impact sockets Scania, Volvo



**BHVIS08**

|        |        |   |               |
|--------|--------|---|---------------|
|        |        |   |               |
| 3/4 in | 95 mm  | 1 | BHVIS0895     |
| 3/4 in | 100 mm | 1 | BHVIS08100    |
| 3/4 in | 115 mm | 1 | BHVIS08115    |
|        | 109 mm | 1 | BHVIS109BPW12 |
|        | 120 mm | 1 | BHVIS120BPW16 |

Wheel hub plate with slide hammer and hydraulic spindle



**BWHEPSSH8**

|       |                 |   |           |
|-------|-----------------|---|-----------|
|       |                 |   |           |
| 12 to | #4-5/116-135 mm | 1 | BWHEPSSH8 |

1/2" impact socket and bit set



**BT15P5**

|                  |   |        |
|------------------|---|--------|
|                  |   |        |
| 60 x 85 x 255 mm | 1 | BT15P5 |

1" thin wall impact sockets



**BHVIS12 / BHVIS06**

|    |        |   |            |
|----|--------|---|------------|
|    |        |   |            |
| 12 | 68 mm  | 1 | BHVIS1265  |
| 6  | 70 mm  | 1 | BHVIS0670  |
| 6  | 77 mm  | 1 | BHVIS0677  |
| 6  | 80 mm  | 1 | BHVIS0680  |
| 6  | 85 mm  | 1 | BHVIS0685  |
| 6  | 90 mm  | 1 | BHVIS0690  |
| 6  | 95 mm  | 1 | BHVIS0695  |
| 6  | 100 mm | 1 | BHVIS06100 |
| 6  | 105 mm | 1 | BHVIS06105 |

Wheel hub hydraulic puller



**BWHEPS**

|       |                   |   |        |
|-------|-------------------|---|--------|
|       |                   |   |        |
| 12 to | #4-5 / 116-135 mm | 1 | BWHEPS |

BWHEP

BWHEHS



Set of wheel hub plate and slide hammer



**BWHEPSH8**

|                   |                    |            |
|-------------------|--------------------|------------|
|                   |                    |            |
| #4-5 / 116-135 mm | 960 x 150 x 150 mm | 1 BWHEPSH8 |

5 kg slide hammer



**BWSH5**

|                    |         |  |
|--------------------|---------|--|
|                    |         |  |
| 100 x 100 x 985 mm | 2 BWSH5 |  |

M18 adaptor



**BWSH51**

|        |        |          |  |
|--------|--------|----------|--|
|        |        |          |  |
| M38 mm | M18x38 | 1 BWSH51 |  |

Wheel hub plate



**BWHEP**

|                   |                   |         |  |
|-------------------|-------------------|---------|--|
|                   |                   |         |  |
| #4-5 / 116-135 mm | 90 x 147 x 147 mm | 1 BWHEP |  |

Slide hammer, 8 kg



**BWSH8**

|                    |         |  |
|--------------------|---------|--|
|                    |         |  |
| 960 x 100 x 100 mm | 1 BWSH8 |  |

Steering Arm Inner Tie Rod Removal Tool Cages



**BS5228-BS523945**

|          |          |          |             |             |             |
|----------|----------|----------|-------------|-------------|-------------|
|          |          |          |             |             |             |
| 28-34 mm | 34-40 mm | 39-35 mm | 1 BS5228341 | 1 BS5234401 | 1 BS5239451 |

12 T hydraulic spindle



**BWHEHS**

|       |            |          |  |
|-------|------------|----------|--|
|       |            |          |  |
| 12 to | 265-282 mm | 1 BWHEHS |  |

3.5 kg mass



**BSSHE3**

|       |        |          |  |
|-------|--------|----------|--|
|       |        |          |  |
| 60 mm | 100 mm | 1 BSSHE3 |  |

Stainless strap and buckles



**BE2512005**



|      |      |             |  |
|------|------|-------------|--|
|      |      |             |  |
| 5 mm | 12 m | 1 BE2512005 |  |



Stainless steel strap pliers



**BE251200**

170 mm   1 BE251200

CV boot installation pneumatic tool



**BPCVB1**

25-110 mm  138 x 138 x 455 mm   6 BPCVB1

Stainless strap and buckles



**BE2512008**

8 mm  15 mm   1 BE2512008

Steering Arm Inner Tie Rod Removal Tool Set.



**BS52**

110 x 315 x 380 mm  3.08 kg   1 BS52

Axle joint tool



**BS54**

57 x 57 x 70 mm  1 BS54

Tie Rod End Extractor



**BS56**

1/2 in  57 x 57 x 57 mm   6 BS56

Rear Axle Eccentric Socket



**BS45BMW**

1/2 in  40 x 43 x 43 mm   20 BS45BMW

Camber Adjusting Tool



**BS40VAG**

22 mm  52 x 92 x 150 mm   20 BS40VAG

Wheel Bearing Tool Set



**BWB14**

80 x 300 x 525 mm   2 BWB14

Bearing removal and installation set



**BT20P26**



150 x 310 x 535 mm

1 BT20P26

Hydraulic Bearing Removal and Installation Set



**BT20P49**



164 x 520 x 890 mm

1 BT20P49

Ball joint fork puller



**BS6**



18 mm

400 mm

1 BS618

23 mm

400 mm

1 BS623

Ball joint extractor set with 12T hydraulic spindle



**BWHPJ12**



12 to

70 mm

4 BWHPJ12

VW T4 Supporting Joint Tool



**4594VWT4**



245 x 112 x 320 mm

5 4594VWT4

Ball joint socket puller for PSA



**BS100PSA1**



56 mm

52 mm

1 BS100PSA1

SAC Clutch Tool Set



**BE301**



80 x 395 x 430 mm

2 BE301

Centring Mandrels Set for SAC Clutches



**BE301CM-SET**



26 x 81.5 x 200 mm

50 BE301CM

BE301CM-01, BE301CM-02

Centring Mandrels for SAC Clutches



**BE301CM**



15.19 mm

174 mm

20 BE301CM-01

20.26 mm

174 mm

20 BE301CM-02





### Clutch alignment rectifier



#### BE310

|                   |         |   |       |
|-------------------|---------|---|-------|
|                   |         |   |       |
| 68 x 225 x 280 mm | 1.14 kg | 8 | BE310 |

|                   |   |          |
|-------------------|---|----------|
|                   |   |          |
| 42 x 160 x 160 mm | 1 | BS15160  |
| 42 x 160 x 170 mm | 1 | BS15160C |
| 42 x 160 x 212 mm | 1 | BS15212  |
| 24 x 160 x 215 mm | 1 | BS15212C |
| 45 x 56 x 95 mm   | 1 | BS1550   |

### Double Pneumatic Piston Shock Absorber Compressor with Protective Screen



#### BS30PG

|                     |       |   |        |
|---------------------|-------|---|--------|
|                     |       |   |        |
| 1180 x 500 x 625 mm | 24 kN | 1 | BS30PG |

### Universal Shock Absorber Blocking System



#### BS10AC2

|                    |      |   |         |
|--------------------|------|---|---------|
|                    |      |   |         |
| 400 x 400 x 200 mm | 1 kg | 1 | BS10AC2 |

### Moving height extension



#### BS30AC1

|                    |   |         |
|--------------------|---|---------|
|                    |   |         |
| 336 x 545 x 450 mm | 1 | BS30AC1 |

### Turnbuckle shock absorber



#### BS1000

|                   |   |          |
|-------------------|---|----------|
|                   |   |          |
| 70 x 405 x 575 mm | 1 | BS1000   |
|                   | 1 | BS100001 |
|                   | 1 | BS100002 |
|                   | 1 | BS100003 |
|                   | 1 | BS100004 |
|                   | 1 | BS100005 |
|                   | 1 | BS100006 |
|                   | 1 | BS100007 |
|                   | 1 | BS100008 |
|                   | 1 | BS100009 |
|                   | 1 | BS100010 |
|                   | 1 | BS100011 |
|                   | 1 | BS100012 |
|                   | 1 | BS100013 |
|                   | 1 | BS100014 |
|                   | 1 | BS100015 |
|                   | 1 | BS100016 |
|                   | 1 | BS100017 |
|                   | 1 | BS100018 |
|                   | 1 | BS100019 |
|                   | 1 | BS100020 |
|                   | 1 | BS100021 |
|                   | 1 | BS100022 |
|                   | 1 | BS100023 |
|                   | 1 | BS100024 |
|                   | 1 | BS100025 |
|                   | 1 | BS100026 |

## SUSPENSION TOOLS & EQUIPMENT

### Suspension arm lever bar



#### BS25

|        |        |   |      |
|--------|--------|---|------|
|        |        |   |      |
| 20 N·m | 200 kg | 1 | BS25 |

### MacPherson spring compressor



#### BS15

|                    |   |          |
|--------------------|---|----------|
|                    |   |          |
| 125 x 425 x 510 mm | 1 | BS15     |
| 43 x 110 x 160 mm  | 1 | BS15125  |
| 165 x 160 x 385 mm | 1 | BS15125C |

|   |          |  |
|---|----------|--|
|   |          |  |
| 1 | BS100027 |  |
| 1 | BS100028 |  |
| 1 | BS100029 |  |
| 1 | BS100030 |  |
| 1 | BS100031 |  |
| 1 | BS100032 |  |
| 1 | BS100033 |  |
| 1 | BS100034 |  |
| 1 | BS100035 |  |
| 1 | BS100036 |  |
| 1 | BS100037 |  |
| 1 | BS100038 |  |
| 1 | BS100039 |  |

Booster 12/24V 2400 / 1200 CA



**BBAGM1224-2400**

|           |               |   |                |
|-----------|---------------|---|----------------|
|           | <b>CA</b>     |   |                |
| 12 / 24 V | 2400 / 1200 A | 1 | BBAGM1224-2400 |

Spare Booster 12V Charging Cable



**BBAGMCAB**

|                  |      |   |          |
|------------------|------|---|----------|
|                  |      |   |          |
| 25 x 80 x 200 mm | 12 V | 1 | BBAGMCAB |

**BATTERY MANAGEMENT & ELECTRICAL TOOLS**

On Board Diagnostic Memory Saver Detector



**BELMS12OBDL**

|                  |   |             |
|------------------|---|-------------|
|                  |   |             |
| 40 x 70 x 140 mm | 8 | BELMS12OBDL |

Spare battery for 12V boosters

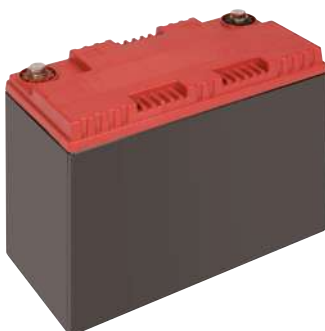

**BBAGMBAT**

|      |        |   |          |
|------|--------|---|----------|
|      |        |   |          |
| 12 V | 25 A·h | 1 | BBAGMBAT |

12V/24V Heavy Duty Booster



**BBA1224-3200**

|         |             |   |              |
|---------|-------------|---|--------------|
|         | <b>CA</b>   |   |              |
| 12/24 V | 3200/1600 A | 1 | BBA1224-3200 |

Booster 12V 1200 CA



**BBAGM12-1200**

|      |           |   |              |
|------|-----------|---|--------------|
|      | <b>CA</b> |   |              |
| 12 V | 1200 A    | 1 | BBAGM12-1200 |

Automatic electronic booster chargers



**BBAGMCHG**

|                   |   |          |
|-------------------|---|----------|
|                   |   |          |
| 70 x 105 x 130 mm | 1 | BBAGMCHG |

12V Hybrid Booster with Capacitors



**BBH12-1200**

|      |           |   |            |
|------|-----------|---|------------|
|      | <b>CA</b> |   |            |
| 12 V | 1200 A    | 1 | BBH12-1200 |



Jumper leads



**BBJL**



|                    |       |   |          |
|--------------------|-------|---|----------|
| 16 mm <sup>2</sup> | 3 m   | 5 | BBJL1630 |
| 25 mm <sup>2</sup> | 3.5 m | 1 | BBJL2535 |
| 35 mm <sup>2</sup> | 4.5 m | 1 | BBJL3545 |

10 Amp Fully Automatic Charger/Maintainer for 12V Batteries



**BBCE12-10**

|          |          |  |             |
|----------|----------|--|-------------|
| <b>V</b> | <b>A</b> |  | 2 BBCE12-10 |
| 12V      | 10A      |  |             |

100A Battery Charger/Power Supply



**BBCE12-F100**

|          |               |  |               |
|----------|---------------|--|---------------|
| <b>V</b> | <b>A</b>      |  | 1 BBCE12-F100 |
| 12V      | 4/20/70/100AA |  |               |

3 Amp Fully Automatic Charger/Maintainer for 12V Lead-acid and Lithium LiFeP04 Batteries



**BBCE12-3**

|          |          |  |            |
|----------|----------|--|------------|
| <b>V</b> | <b>A</b> |  | 2 BBCE12-3 |
| 12V      | 3A       |  |            |

15 Amp Fully Automatic Charger/Maintainer for 12V Batteries with Supply Mode



**BBCE12-15S**

|          |          |  |              |
|----------|----------|--|--------------|
| <b>V</b> | <b>A</b> |  | 2 BBCE12-15S |
| 12V      | 10/15A   |  |              |

Mobile charger/starter



**BBC420-BBC620**

|          |             |  |          |
|----------|-------------|--|----------|
| <b>V</b> |             |  | 1 BBC420 |
| 230 V    | 20/1000 A-h |  |          |
| 230 V    | 20/1550 A-h |  | 1 BBC620 |

6 Amp Fully Automatic Charger/Maintainer for 12V Batteries



**BBCE12-6**

|          |          |  |            |
|----------|----------|--|------------|
| <b>V</b> | <b>A</b> |  | 2 BBCE12-6 |
| 12V      | 6A       |  |            |

10 Amp Fully Automatic Charger/Maintainer for 24V Batteries



**BBCE24-10**

|          |          |  |             |
|----------|----------|--|-------------|
| <b>V</b> | <b>A</b> |  | 2 BBCE24-10 |
| 24V      | 10A      |  |             |

Hydrometer battery tester



**BB10**

|                  |  |        |
|------------------|--|--------|
|                  |  | 1 BB10 |
| 50 x 50 x 285 mm |  |        |

12V digital battery tester



**BBT20**



90 x 160 x 345 mm

1 BBT20

Digital multimeter, autoranging, true RMS 1000V, with port for connection to PC



**BMMTRMS1**



155 x 60 x 225 mm

0.8 kg

1 BMMTRMS1

IR & RF key tester



**BELTKEY**



35 x 63 x 160 mm

1 BELTKEY

12V Digital Battery Tester



**BBT60A**



27 x 95 x 135 mm

36 BBT60A

1000V Voltage Absence Tester, Non-Contact Voltage Tester



**BMVAT1000**



310 x 50 x 100 mm

0.302 kg

50 BMVAT1000

Socket tester 7 pin 12V



**BELT127**



35 x 63 x 160 mm

1 BELT127

6V & 12V Digital Battery Tester with Printer



**BBT80**



64 x 130 x 251 mm

6 BBT80

1000A AC/DC True RMS Digital Clamp Meter



**BDACM1000**



60 x 143 x 250 mm

0.551 kg

30 BDACM1000

12V Vehicle Lamps Operation Plug Socket Tester



**BELT1213A**



40 x 138 x 205 mm

1.726 kg

20 BELT1213A





24V Vehicle Lamps Operation Plug Socket Tester



**BELT2415A**

40 x 138 x 205 mm 1.897 kg 20 BELT2415A

Socket tester 7 Pin 24V (24N)



**BELT247N**

55 x 63 x 160 mm 1 BELT247N

Socket tester 7 pin 24V (24S)



**BELT247S**

35 x 63 x 155 mm 1 BELT247S

Professional gas soldering iron



**BGIS125**

25-125 W 46 x 88 x 295 mm 20 BGIS125

Terminal set 16 pcs



**BELTRP16**

58 x 215 x 265 mm

- 1 BELTRP16
- 1 BELTRP1601
- 1 BELTRP1602
- 1 BELTRP1603
- 1 BELTRP1604
- 1 BELTRP1605
- 1 BELTRP1606
- 1 BELTRP1607
- 1 BELTRP1608
- 1 BELTRP1609
- 1 BELTRP1610
- 1 BELTRP1611
- 1 BELTRP1612
- 1 BELTRP1613
- 1 BELTRP1614
- 1 BELTRP1615
- 1 BELTRP1616

Memory saver 12V



**BELS12**

35 x 63 x 160 mm 1 BELS12

12V/24V peak protector



**BELP1224**

35 x 63 x 160 mm 1 BELP1224

Battery clamps (quick connect) for BBCE612-2, BBCE12-3 and BBCE12-6 chargers



**BBCEC1**

68 g 1 BBCEC1

Ring connectors (quick connect) for BBCE612-2, BBCE12-3 and BBCE12-6 chargers



**BBCER1**

100 g 1 BBCER1



Battery Clamps (quick connect) for Battery Clamps (quick connect) for BBCE12-10 and BBCE24-10 chargers



**BBCEC2**

|      |   |        |
|------|---|--------|
|      |   |        |
| 68 g | 1 | BBCEC2 |

Ring connectors (quick connect) for BBCE12-10 and BBCE24-10 chargers



**BBCER2**

|       |   |        |
|-------|---|--------|
|       |   |        |
| 100 g | 1 | BBCER2 |

Booster charger cables - spares



**BBBCAB**

|                  |   |            |
|------------------|---|------------|
|                  |   |            |
| 50 x 125 x 50 mm | 1 | BBBCAB-AUZ |
| 50 x 125 x 50 mm | 1 | BBBCAB-EU  |
| 50 x 50 x 50 mm  | 1 | BBBCAB-UK  |

**PRESSES & ACCESSORIES**

Bench Press, 15 Tonne



**BH715**

|           |   |       |
|-----------|---|-------|
|           |   |       |
| 15.000 kg | 1 | BH715 |

Press, 20T, 30T and 50T

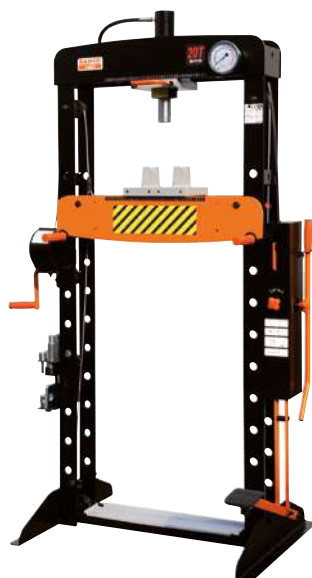

**BH720/BH730/BH750**

|           |   |       |
|-----------|---|-------|
|           |   |       |
| 20.000 kg | 1 | BH720 |
| 30.000 kg | 1 | BH730 |
| 50.000 kg | 1 | BH750 |

Hydro-pneumatic press 100T



**BH7100**

|           |   |         |
|-----------|---|---------|
|           |   |         |
| 100000 kg | 1 | BH7100A |

Universal Press Supports 30 t



**BH7PS30**

|                    |   |         |
|--------------------|---|---------|
|                    |   |         |
| 225 x 100 x 275 mm | 2 | BH7PS30 |

Press pins set for presses



**BH715-13**

|         |   |          |
|---------|---|----------|
|         |   |          |
| 7.09 kg | 1 | BH715-13 |
| 7.09 kg | 1 | BH720-22 |



Safety grids for presses 15, 20, 30 and 50T



**BH7 SG**

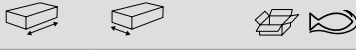

|        |       |   |         |
|--------|-------|---|---------|
| 530 mm | 20 mm | 1 | BH720SG |
| 590 mm | 20 mm | 1 | BH730SG |
| 625 mm | 20 mm | 1 | BH750SG |

Safety grid for press 100ton



**BH7100SG**



|                    |         |   |          |
|--------------------|---------|---|----------|
| 150 x 593 x 625 mm | 5.54 kg | 1 | BH7100SG |
|--------------------|---------|---|----------|

**GENERAL AUTOMOTIVE TOOLS AND EQUIPMENT**

Multi-Purpose Tables



**BLEMAT1**



|                    |         |   |         |
|--------------------|---------|---|---------|
| 860 x 155 x 780 mm | 28.7 kg | 1 | BLEMAT1 |
|--------------------|---------|---|---------|

Multi-Purpose Table Bottom Trays



**BLEMAT1BT**



|                   |         |   |           |
|-------------------|---------|---|-----------|
| 50 x 760 x 890 mm | 10.5 kg | 1 | BLEMAT1BT |
|-------------------|---------|---|-----------|

Set of 4 Storage/Protection Bags for Wheels and Tyres



**BWB1418S4/BWB1922S4**



|              |   |           |
|--------------|---|-----------|
| 355 - 470 mm | 6 | BWB1418S4 |
| 470 - 560 mm | 6 | BWB1922S4 |

Magnetic dish



**1419-MD**



|        |   |         |
|--------|---|---------|
| 150 mm | 1 | 1419-MD |
|--------|---|---------|

Round magnetic dish



**BMD150**

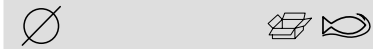

|        |   |        |
|--------|---|--------|
| 160 mm | 1 | BMD150 |
|--------|---|--------|

Rectangular magnetic tray



**BMR240**

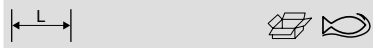

|        |   |        |
|--------|---|--------|
| 250 mm | 1 | BMR240 |
|--------|---|--------|

Pneumatic stool



**BLE305**



|                    |   |        |
|--------------------|---|--------|
| 430 x 410 x 430 mm | 1 | BLE305 |
|--------------------|---|--------|

Pneumatic stool



**BLE300**



380 x 380 x 550 mm 136 kg 1 BLE300

Creepers and stool set



**BLE304**

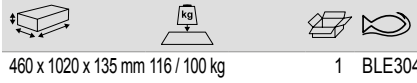

460 x 1020 x 135 mm 116 / 100 kg 1 BLE304

Car panel protector



**BBS50**



900 mm 1.2 mm 1 BBS50

Creepers and stool combo



**BLE302**



135 x 490 x 1010 mm 136 kg 1 BLE302

Seat cover



**5750**



1390 mm 1 5750

Dual Laser Headlamp Tester



**BLBT100**



1650 x 500 x 565 mm 1 BLBT100

Low profile creeper



**BLE301**

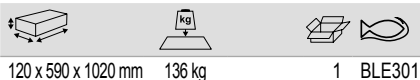

120 x 590 x 1020 mm 136 kg 1 BLE301

Multipurpose Vehicle Front Body Protector



**5770**

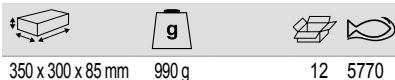

350 x 300 x 85 mm 990 g 12 5770

Rail track for BLBT100



**BLBT100AC1**



150 x 150 x 1025 mm 7.77 kg 1 BLBT100AC1



Multi-position ratcheting pry bar set



**BT10P3**



80 x 270 x 375 mm



1 BT10P3

Multi Position Prybar



**BT10P325-BT10P338**



250 mm  
300 mm  
380 mm



40 BT10P325  
1 BT10P330  
1 BT10P338

Long Pry Bar Set with Rubber Grip



**BPBLS4**



78 x 255 x 1000 mm



9050 g



2 BPBLS4

BPBL00900, BPBL30900, BPBL70600,  
BPBL90600

Long Pry Bars with Rubber Grip



**BPBL**



930 mm  
925 mm  
610 mm  
628 mm



5 BPBL00900  
5 BPBL30900  
5 BPBL70600  
5 BPBL90600

**BODY SHOP TOOLS**

Universal holder with rubber vacuum pads



**BBS3BH1**



955 mm



1 BBS3BH1

Holder for bodywork shop



**BBS3UH**



950 x 800 x 1200 mm



20 kg



1 BBS3UH

Rubber suction cup



**BBS075**



160 mm



175 mm



12 BBS075

Vacuum Pad for Universal Holder



**BBS3BH1-VP**



60 x 95 x 95 mm



40 BBS3BH1-VP

Two double suction cups and belt



**BBS150**



120 mm



400 mm



1 BBS150

Glass run channel cleaner



**BBS106**

|                  |          |   |        |
|------------------|----------|---|--------|
|                  |          |   |        |
| 25 x 25 x 332 mm | 0.145 kg | 1 | BBS106 |

Wire starter



**BBS103**

|                  |   |        |
|------------------|---|--------|
|                  |   |        |
| 25 x 25 x 345 mm | 1 | BBS103 |

T-handle wire pushing tool



**BBS102**

|        |   |        |
|--------|---|--------|
|        |   |        |
| 265 mm | 1 | BBS102 |

Wire grip handle set



**BBS101**

|                  |   |        |
|------------------|---|--------|
|                  |   |        |
| 30 x 80 x 115 mm | 1 | BBS101 |

Windscreen cut-out wires



**BBS150S**

|      |   |         |
|------|---|---------|
|      |   |         |
| 50 m | 1 | BBS150R |
| 50 m | 1 | BBS150S |
| 50 m | 1 | BBS150T |

Windscreen cut-out tool



**BBS105**

|                  |   |        |
|------------------|---|--------|
|                  |   |        |
| 20 x 90 x 200 mm | 1 | BBS105 |

Urethane cutting knife



**BBS10450**

|                  |          |   |          |
|------------------|----------|---|----------|
|                  |          |   |          |
| 10 x 30 x 450 mm | 0.240 kg | 1 | BBS10450 |

Blades for windscreen cut-out tool



**BBS107**

|                 |   |        |
|-----------------|---|--------|
|                 |   |        |
| 1 x 18 x 125 mm | 1 | BBS107 |

Blades for windscreen cut-out tool



**BBS108**

|                 |   |        |
|-----------------|---|--------|
|                 |   |        |
| 20 x 19 x 88 mm | 1 | BBS108 |

WIPER ARM PULLER SET



**BBS165**

|                  |    |        |
|------------------|----|--------|
|                  |    |        |
| 117 x 25 x 78 mm | 10 | BBS165 |





Wiper puller set



**BBS170P13**



80 x 275 x 375 mm



- 1 BBS170P13
- 1 BBS170P131
- 1 BBS170P132
- 1 BBS170P133
- 1 BBS170P134
- 1 BBS170P135
- 1 BBS170P136
- 1 BBS170P137
- 1 BBS170P138
- 1 BBS170P139
- 50 BBS165SP4

Bodywork dressing hammer



**BBSH1M**



50x30 mm



1 BBSH1M

Bodywork pein & finishing hammer



**BBSH2F**



40 mm



6 BBSH2F

Bodywork pein & finishing hammer



**BBSH2C**



40 mm



1 BBSH2C

Bodywork bumping hammer



**BBSH3CF**



40 mm



37 mm



6 BBSH3CF

12 kg slide hammer



**BBS12SH**



800 mm



12 kg



1 BBS12SH

Bodywork angled pein & finishing hammer



**BBSH2CA**



40 mm



12 BBSH2CA

Bodywork shop light bumping hammer



**BBSH3CF30**



30 mm



25 mm



6 BBSH3CF30

Bodywork dressing hammer



**BBSH1F**



50x30 mm



1 BBSH1F

Bodywork pick & finishing hammer



**BBSH2CP**



40 mm



6 BBSH2CP

Bodywork light shrinking hammer



**BBSH3FS**



37 mm



40 mm



6 BBSH3FS

Bodywork shrinking hammer



**BBSH3MF**



30 mm 27 mm 1 BBSH3MF

Spare handle for BBSH hammers



**BBSHWH1**

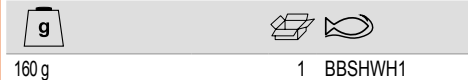

160 g 1 BBSHWH1

Bodywork American dolly



**BBSDA**



30 x 63 x 83 mm 1 BBSDA

Bodywork comma dolly



**BBSDC**



40 x 58 x 128 mm 6 BBSDC

Bodywork diablo dolly



**BBSDD**

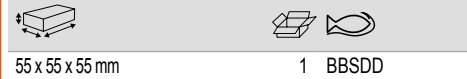

55 x 55 x 55 mm 1 BBSDD

Bodywork heel dolly



**BBSDH**

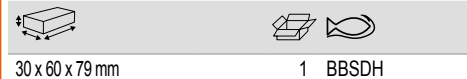

30 x 60 x 79 mm 1 BBSDH

Bodywork toe dolly



**BBSDT**

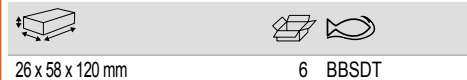

26 x 58 x 120 mm 6 BBSDT

Bodywork wedge dolly



**BBSDW**



25 x 64 x 112 mm 6 BBSDW

Rubber heel dolly



**BBSDHR**

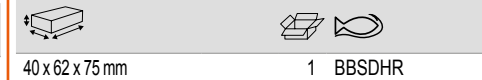

40 x 62 x 75 mm 1 BBSDHR

Bodywork single spoon



**BBSS1**



25 x 56 x 390 mm 1 BBSS1

Bodywork double spoon short



**BBSS2**



150 x 60 x 410 mm 8 BBSS2

Bodywork double spoon long



**BBSS2L**



175 x 60 x 520 mm 2.3 kg 1 BBSS2L



Trim pad remover



**2485**



240 mm



1 2485

Trim pad removal pliers



**BBS200**



65 x 75 x 250 mm



1 BBS200

Trim remover



**BBS20P12**



35 x 355 x 585 mm



1 BBS20P12

Plastic repair set



**BBS210**



100 x 280 x 360 mm  
22 x 64 x 106 mm  
22 x 64 x 106 mm  
22 x 64 x 106 mm  
22 x 64 x 106 mm  
22 x 64 x 106 mm  
22 x 64 x 106 mm  
22 x 64 x 106 mm  
22 x 64 x 106 mm



1 BBS210  
1 BBS210U06  
1 BBS210U08  
1 BBS210UA06  
1 BBS210UA08  
1 BBS210V06  
1 BBS210V08  
1 BBS210W06  
1 BBS210W08

Airbag removal tool set 12 pcs



**BBS100**



55 x 160 x 275 mm



1 BBS100  
1 BBS10001  
1 BBS10002  
1 BBS10003  
1 BBS10004  
1 BBS10005  
1 BBS100057  
1 BBS10006  
1 BBS10007  
1 BBS10008  
1 BBS10009  
1 BBS10010

Bodywork scraper set, 4 pcs



**2220**



125 g



1 22209004B

Nut riveter



**1468-M6**



20 x 110 x 265 mm



1 1468-M6

Nut riveter



**1468-M10**



50 x 210 x 575 mm



6 1468-M10

1468-M6 nut riveter inserts



**1468-6M**



|                 |   |          |
|-----------------|---|----------|
| 15 x 15 x 50 mm | 1 | 1468-6M3 |
| 13 x 13 x 50 mm | 1 | 1468-6M4 |
| 25 x 25 x 55 mm | 1 | 1468-6M5 |
| 20 x 20 x 55 mm | 1 | 1468-6M6 |

1468-M10 Nut Riveter inserts



**1468-10M**



|                 |   |            |
|-----------------|---|------------|
| 17 x 17 x 90 mm | 1 | 1468-10M4  |
| 17 x 17 x 90 mm | 1 | 1468-10M5  |
| 20 x 20 x 90 mm | 1 | 1468-10M6  |
| 20 x 20 x 85 mm | 1 | 1468-10M8  |
| 20 x 20 x 85 mm | 1 | 1468-10M10 |

Portable ram sets 4T and 10T



**BH8PR**



|                     |          |   |            |
|---------------------|----------|---|------------|
| 220 x 480 x 1030 mm | 31 kg    | 1 | BH8PR10000 |
| 168 x 345 x 575 mm  | 18.65 kg | 1 | BH8PR4000  |

Body clamps



**BH8BC1**



|                   |   |        |
|-------------------|---|--------|
| 45 x 135 x 230 mm | 1 | BH8BC1 |
|-------------------|---|--------|

Body clamps



**BH8BC2**



|                   |   |        |
|-------------------|---|--------|
| 51 x 150 x 220 mm | 1 | BH8BC2 |
|-------------------|---|--------|

Body clamps



**BH8BC3**



|                  |    |        |
|------------------|----|--------|
| 90 x 65 x 240 mm | 10 | BH8BC3 |
|------------------|----|--------|

Body clamps



**BH8BC4**



|                   |   |        |
|-------------------|---|--------|
| 80 x 120 x 175 mm | 6 | BH8BC4 |
|-------------------|---|--------|

Body clamps



**BH8BC5**



|                   |   |        |
|-------------------|---|--------|
| 45 x 155 x 230 mm | 6 | BH8BC5 |
|-------------------|---|--------|

**LIFTING EQUIPMENT**

Welded bottle jack



**BH4S**



|          |                    |   |        |
|----------|--------------------|---|--------|
| 2000 kg  | 180 x 83 x 93 mm   | 6 | BH4S2  |
| 4000 kg  | 190 x 91 x 100 mm  | 6 | BH4S4  |
| 6000 kg  | 215 x 96 x 114 mm  | 4 | BH4S6  |
| 8000 kg  | 230 x 103 x 120 mm | 4 | BH4S8  |
| 12000 kg | 235 x 117 x 135 mm | 3 | BH4S12 |
| 20000 kg | 240 x 145 x 153 mm | 1 | BH4S20 |
| 50000 kg | 240 x 315 x 220 mm | 1 | BH4S50 |



Premium quality welded bottle jack



**BH4**

| Weight   | Dimensions         | Quantity | Model |
|----------|--------------------|----------|-------|
| 2000 kg  | 180 x 103 x 103 mm | 1        | BH42  |
| 5000 kg  | 210 x 110 x 110 mm | 1        | BH45  |
| 10000 kg | 220 x 124 x 128 mm | 1        | BH410 |
| 15000 kg | 235 x 140 x 140 mm | 2        | BH415 |
| 20000 kg | 240 x 165 x 160 mm | 1        | BH420 |
| 30000 kg | 245 x 185 x 175 mm | 2        | BH430 |

2.5 T Aluminium Trolley Jack



**BH1A2500A**

| Weight  | Dimensions         | Quantity | Model     |
|---------|--------------------|----------|-----------|
| 2500 kg | 205 x 385 x 800 mm | 1        | BH1A2500A |

Extra low entry, extra long reach



**BH11500**

| Weight  | Dimensions          | Quantity | Model   |
|---------|---------------------|----------|---------|
| 1500 kg | 1270 x 364 x 945 mm | 1        | BH11500 |

Air Hydraulic Welded Bottle Jacks



**BH4HP50**

| Weight   | Dimensions         | Quantity | Model   |
|----------|--------------------|----------|---------|
| 50000 kg | 300 x 210 x 310 mm | 1        | BH4HP50 |

Trolley jack, 3T



**BH1EU3000**

| Weight  | Dimensions          | Quantity | Model     |
|---------|---------------------|----------|-----------|
| 3000 kg | 1400 x 340 x 617 mm | 1        | BH1EU3000 |

Extra low entry



**BH12000**

| Weight  | Dimensions          | Quantity | Model   |
|---------|---------------------|----------|---------|
| 2000 kg | 1270 x 364 x 780 mm | 1        | BH12000 |

1.5 T Aluminium Trolley Jack



**BH1A1500A**

| Weight  | Dimensions         | Quantity | Model     |
|---------|--------------------|----------|-----------|
| 1500 kg | 170 x 370 x 660 mm | 1        | BH1A1500A |

Trolley jack, 1T



**BH1M1000**

| Weight  | Dimensions          | Quantity | Model    |
|---------|---------------------|----------|----------|
| 1000 kg | 1280 x 478 x 700 mm | 1        | BH1M1000 |

Trolley jack 3T



**BH13000**

| Weight  | Dimensions          | Quantity | Model   |
|---------|---------------------|----------|---------|
| 3000 kg | 1280 x 364 x 825 mm | 1        | BH13000 |



3T trolley jack with Quick Approach



**BH13000QA**

|         |                    |   |           |
|---------|--------------------|---|-----------|
|         |                    |   |           |
| 3000 kg | 220 x 395 x 900 mm | 1 | BH13000QA |

Cross beam adaptor, 1 T



**BH1CB1000**

|         |                    |   |           |
|---------|--------------------|---|-----------|
|         |                    |   |           |
| 1000 kg | 145 x 125 x 710 mm | 1 | BH1CB1000 |

3T long chassis high elevation trolley jack



**BH13000L**

|         |                      |   |          |
|---------|----------------------|---|----------|
|         |                      |   |          |
| 3000 kg | 1310 x 530 x 1370 mm | 1 | BH13000L |

Extra Long Trolley Jack, 5T



**BH15000B**

|         |                     |   |          |
|---------|---------------------|---|----------|
|         |                     |   |          |
| 5000 kg | 330 x 520 x 1670 mm | 1 | BH15000B |

10T Extra Long Trolley Jack



**BH110000B**

|          |                     |   |           |
|----------|---------------------|---|-----------|
|          |                     |   |           |
| 10000 kg | 270 x 520 x 1670 mm | 1 | BH110000B |

120 mm extensions for jacks ref. BH15000A and ref. BH110000A



**BH15000A-EXT/BH110000A-EXT**

|        |  |   |               |
|--------|--|---|---------------|
|        |  |   |               |
| 108 mm |  | 1 | BH15000A-EXT  |
| 151 mm |  | 1 | BH110000A-EXT |

Scissor jack, 4T - 5T



**BH1S45**

|         |                     |   |        |
|---------|---------------------|---|--------|
|         |                     |   |        |
| 4000 kg | 1194 x 212 x 680 mm | 1 | BH1S45 |

Spare rubber saddle



**BH1RS**

|   |  |    |              |
|---|--|----|--------------|
|   |  |    |              |
| BH1A1500A   |  | 40 | BH1A1500A-05 |
| BH1EU3000   |  | 1  | BH1EU3000-03 |
| BH11500, BH12000, BH13000, BH13000QA, BH13000L, BH1M1000, BH1A2500A |  | 1  | BH11500-04   |
| BH15000A  |  | 1  | BH15000A-04  |
| BH110000A   |  | 1  | BH110000A-04 |

Spare front wheels for jacks



**BH1 FW**

|                            |  |   |              |
|----------------------------|--|---|--------------|
|                            |  |   |              |
| BH1A2500                   |  | 1 | BH1A2500-03  |
| BH13000                    |  | 1 | BH13000-02   |
| BH1EU3000                  |  | 1 | BH1EU3000-01 |
| BH1M1000, BH11500, BH12000 |  | 1 | BH11500-02   |
| BH1S45                     |  | 1 | BH1S45-03    |
| BH15000A                   |  | 1 | BH15000A-02  |
| BH110000A                  |  | 1 | BH110000A-02 |



2 step balloon jacks



**BH9BJ22SSH**

|         |                    |   |            |
|---------|--------------------|---|------------|
|         |                    |   |            |
| 2000 kg | 345 x 265 x 265 mm | 1 | BH9BJ22SSH |

2 step balloon jacks



**BH9BJ22**

|         |                     |   |            |
|---------|---------------------|---|------------|
|         |                     |   |            |
| 2000 kg | 1000 x 265 x 265 mm | 1 | BH9BJ22SLH |

3 step balloon jacks



**BH9BJ23SSH**

|         |                    |   |            |
|---------|--------------------|---|------------|
|         |                    |   |            |
| 2000 kg | 490 x 250 x 250 mm | 1 | BH9BJ23SSH |

3 step balloon jacks



**BH9BJ23**

|         |                     |   |            |
|---------|---------------------|---|------------|
|         |                     |   |            |
| 2000 kg | 1000 x 250 x 250 mm | 1 | BH9BJ23SLH |

Extensions for pneumatic stage jacks



**BH9BJ260\_80**

|                 |   |                      |
|-----------------|---|----------------------|
|                 |   |                      |
| 970 g<br>1180 g | 1 | BH9BJ260<br>BH9BJ280 |

Air hydraulic jack, 30T



**BH230**

|                  |   |       |  |
|------------------|---|-------|--|
|                  |   |       |  |
| 360 mm<br>627 mm | 1 | BH230 |  |

Compact air hydraulic jack, 15T - 30T



**BH23015C**

|          |                     |   |          |
|----------|---------------------|---|----------|
|          |                     |   |          |
| 30000 kg | 1350 x 290 x 430 mm | 1 | BH23015C |

Air-hydraulic jack 30T/15T



**BH23015**

|          |                     |   |         |
|----------|---------------------|---|---------|
|          |                     |   |         |
| 30000 kg | 1250 x 282 x 810 mm | 1 | BH23015 |

Extra low entry air-hydraulic



**BH2402010**

|          |                     |   |           |
|----------|---------------------|---|-----------|
|          |                     |   |           |
| 40000 kg | 1225 x 302 x 825 mm | 1 | BH2402010 |

Air-hydraulic



**BH2604020**

|          |                     |   |           |
|----------|---------------------|---|-----------|
|          |                     |   |           |
| 60000 kg | 1250 x 295 x 875 mm | 1 | BH2604020 |

Pair of aluminium of jack stands, 2,500kg capacity



**BH3AL2500**

|         |   |           |
|---------|---|-----------|
|         |   |           |
| 2500 kg | 1 | BH3AL2500 |

Square base jack stand



**BH3SQ**

|                     |   |                         |
|---------------------|---|-------------------------|
|                     |   |                         |
| 7000 kg<br>15000 kg | 2 | BH3SQ7000<br>BH3SQ15000 |

Air Hydraulic Jacks 80/50T



**BH28050**

|          |                     |   |         |
|----------|---------------------|---|---------|
|          |                     |   |         |
| 80000 kg | 380 x 470 x 1200 mm | 1 | BH28050 |

Jack stands (pair)



**BH33000/BH36000**

|                    |   |                    |
|--------------------|---|--------------------|
|                    |   |                    |
| 3000 kg<br>6000 kg | 1 | BH33000<br>BH36000 |

Heavy duty jack stand



**BH3HD8000**

|         |   |           |
|---------|---|-----------|
|         |   |           |
| 8000 kg | 2 | BH3HD8000 |

Adaptor set



**BH2AC**

|                |          |   |                  |
|----------------|----------|---|------------------|
|                |          |   |                  |
| 67 mm<br>75 mm | 45-75 mm | 1 | BH2AC1<br>BH2AC2 |

Auto-rising jack stands



**BH3A**

|                                |   |                                   |
|--------------------------------|---|-----------------------------------|
|                                |   |                                   |
| 3000 kg<br>5000 kg<br>10000 kg | 1 | BH3A3000<br>BH3A5000<br>BH3A10000 |

Heavy duty jack stand



**BH3HD12000**

|          |   |            |
|----------|---|------------|
|          |   |            |
| 12000 kg | 1 | BH3HD12000 |



Heavy duty jack stand



**BH3HD16000**



16000 kg 1 BH3HD16000

Hydraulic transmission jack double piston 1000kg capacity



**BH5DP1000QA**



1000 kg 1954 x 759 x 759 mm 1 BH5DP1000QA

Storage rack for car dollies



**BH1CD680ST**

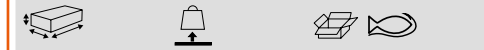

715 x 130 x 155 mm 135 kg 1 BH1CD680ST

20T Heavy Duty Jack Stand



**BH3HD20000A**

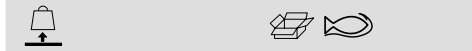

20000 kg 1 BH3HD20000A

Universal saddle for transmission jacks



**BH5US1000**



250 x 340 x 420 mm 260-510 mm 1 BH5US1000

Hydraulic Wheel Dolly 600kg capacity



**BH8AC3-600**



1030 x 1050 x 1020 mm 93.5 kg 1 BH8AC3-600

Hydraulic transmission jack single piston 500kg capacity



**BH5SP500QA**



500 kg 2041 x 660 x 660 mm 1 BH5SP500QA

Car dolly for vehicle manoeuvring



**BH1CD680**



16.22 kg 610 x 240 x 220 mm 1 BH1CD680

Hydraulic Wheel Dolly, 1.5T



**BH8AC3-1500A**



310 x 1070 x 1345 mm 132 kg 1 BH8AC3-1500A

Foldable europallet crane, 600 kg



**BH6PC600**

|                       |       |   |          |
|-----------------------|-------|---|----------|
|                       |       |   |          |
| 2315 x 1040 x 1480 mm | 96 kg | 1 | BH6PC600 |

Foldable crane, 2T



**BH6FC2000**

|                       |        |   |           |
|-----------------------|--------|---|-----------|
|                       |        |   |           |
| 2640 x 1220 x 1845 mm | 170 kg | 1 | BH6FC2000 |

Hydraulic ISO VG15 oil spare can 250 ml



**BHVG15-250**

|                  |       |   |            |
|------------------|-------|---|------------|
|                  |       |   |            |
| 160 x 60 x 60 mm | 220 g | 1 | BHVG15-250 |

Foldable crane 1T



**BH6FC1000**

|                       |       |   |           |
|-----------------------|-------|---|-----------|
|                       |       |   |           |
| 2175 x 1030 x 1480 mm | 85 kg | 1 | BH6FC1000 |

Engine Hoist Load Balancer



**BH6AC1-680A**

|                   |  |   |             |
|-------------------|--|---|-------------|
|                   |  |   |             |
| 565 x 12 x 774 mm |  | 1 | BH6AC1-680A |

Spare rear wheels for jacks



**BH1\_RW**

|                                     |   |              |
|-------------------------------------|---|--------------|
|                                     |   |              |
| BH1A1500                            | 1 | BH1A1500-04  |
| BH1A2500                            | 1 | BH1A2500-04  |
| BH1M1000, BH11500, BH12000, BH13000 | 1 | BH11500-01   |
| BH1EU3000                           | 1 | BH1EU3000-08 |
| BH13000L                            | 1 | BH13000L-01  |
| BH1S45-01                           | 1 | BH1S45-01    |
| BH15000A, BH110000A                 | 1 | BH15000A-01  |







**BAHCO**



# Lighting Equipment



## HAND LIGHTS

Pocket Lamps with Torch



### BLTS7P

|       |    |        |
|-------|----|--------|
|       |    |        |
| 45 lm | 58 | BLTS7P |

Aluminium Flex Work Lights with Torch



### BLTFC1

|        |    |        |
|--------|----|--------|
|        |    |        |
| 180 lm | 20 | BLTFC1 |

Slim Lights with Torch



### BLTS10

|        |    |        |
|--------|----|--------|
|        |    |        |
| 400 lm | 20 | BLTS10 |

## HEAD LIGHTS

Head Lights with Elastic Strap



### BFRL11

|        |   |        |
|--------|---|--------|
|        |   |        |
| 260 lm | 1 | BFRL11 |

## CABLE REELS

2-Phase 230 VAC Cable Reels without Lamp



### BLCR230

|       |            |   |           |
|-------|------------|---|-----------|
|       |            |   |           |
| 230 V | 800/2000 W | 1 | BLCR230FR |
| 230 V | 800/2000 W | 1 | BLCR230SC |

Lamps with Cable Reels



### BLCR24V

|          |      |   |           |
|----------|------|---|-----------|
|          |      |   |           |
| 230/24 V | 60 W | 1 | BLCR24VCL |
| 230/24 V | 60 W | 1 | BLCR24VLL |

3-Phase 400 VAC Cable Reels without Lamp



### BLCR400E

|       |             |   |          |
|-------|-------------|---|----------|
|       |             |   |          |
| 400 V | 2800/5000 W | 1 | BLCR400E |

Speed Control Adaptors for Cable Reels



### BLCRSC

|             |                  |           |
|-------------|------------------|-----------|
|             |                  |           |
| BLCR        |                  |           |
| 230PL,FR,SC | 76 x 91 x 117 mm | 1 BLCRSC1 |
| 24VCL,VLL   | 76 x 91 x 117 mm | 1 BLCRSC2 |



# Inspection Tools



## ENDOSCOPES

Handheld Videoscopes with 3.5" LCD Screen



### BE210

| Dimensions      | Weight (kg) | Accessories  |
|-----------------|-------------|--------------|
| 5 x 50 x 56 mm  | 0.04 kg     | 1 ZHVIDEOBAT |
| 40 x 44 x 75 mm | 0.17 kg     | 1 ZHVIDEOCHA |

Mirrored and Magnetic Tips for Endoscopes



### BE200M

| Angle | Tip Type | Quantity | Part Number    |
|-------|----------|----------|----------------|
| 0°    | Magnetic | 4        | 1 BE200MAG4    |
| 0°    | Mirrored | 5.5, 5.8 | 1 BE200MAG55   |
|       | Magnetic | 8        | 1 BE200MAG80   |
| 35°   | Mirrored | 5.5, 5.8 | 1 BE200MIR5535 |
| 45°   | Mirrored | 5.5, 5.8 | 1 BE200MIR5545 |
| 55°   | Mirrored | 5.5, 5.8 | 1 BE200MIR5555 |
| 35°   | Magnetic | 8        | 1 BE200MIR8035 |
| 45°   | Magnetic | 8        | 1 BE200MIR8045 |
| 55°   | Magnetic | 8        | 1 BE200MIR8055 |
| 35°   | Mirrored | 4        | 1 BE200MIR4035 |
| 55°   | Mirrored | 4        | 1 BE200MIR4055 |

Stethoscopes with Steel Probe



### 5050

| Length  | Quantity | Part Number |
|---------|----------|-------------|
| 1050 mm | 1        | 5050        |

Fibre Optic Lens Cables for Endoscopes



### BE200C

| Tip Diameter | Length | Quantity | Part Number     |
|--------------|--------|----------|-----------------|
| 25 mm        | 10 m   | 1        | BE200CAB250SH10 |
| 25 mm        | 25 m   | 1        | BE200CAB250SH25 |
| 25 mm        | 3 m    | 1        | BE200CAB250SH3  |
| 4 mm         | 1 m    | 1        | BE200CAB40F1    |
| 5.5 mm       | 1 m    | 1        | BE200CAB55F1    |
| 5.5 mm       | 3 m    | 1        | BE200CAB55F3    |
| 5.8 mm       | 1 m    | 1        | BE200CAB58SR1   |
| 5.8 mm       | 3 m    | 1        | BE200CAB58SR3   |
| 8 mm         | 1 m    | 1        | BE200CAB80SR1   |
| 8 mm         | 3 m    | 1        | BE200CAB80SR3   |

## STETHOSCOPES

Garage Stethoscope Set



### BE220

| Dimensions         | Weight (kg) | Quantity | Part Number |
|--------------------|-------------|----------|-------------|
| 130 x 370 x 340 mm | 2.94 kg     | 1        | BE220       |

Magnifying Swivel Head Mirrors



### 5515GV

| Length | Head Diameter | Quantity | Part Number |
|--------|---------------|----------|-------------|
| 215 mm | 30 mm         | 1        | 5515GV      |

Telescopic Swivel Head Mirrors 52 mm



### 5515T-52

| Length     | Head Diameter | Quantity | Part Number |
|------------|---------------|----------|-------------|
| 255-450 mm | 52 mm         | 25       | 5515T-52    |



Pivoting Inspection Mirror with LED and Insulated Semi-rigid Cable



**5515FL**

|        |            |    |        |
|--------|------------|----|--------|
|        |            |    |        |
| 550 mm | 62 x 38 mm | 10 | 5515FL |

Repair Mirrors with Metal Handle 30 mm



**5515M**

|        |       |   |       |
|--------|-------|---|-------|
|        |       |   |       |
| 210 mm | 30 mm | 1 | 5515M |

**MAGNIFIERS**

Optical Magnifier



**BOM10X**

|        |    |        |
|--------|----|--------|
|        |    |        |
| 180 mm | 10 | BOM10X |

Pivoting Inspection Mirror with UV and Insulated Semi-rigid Cable



**5515FUV**

|        |          |   |         |
|--------|----------|---|---------|
|        |          |   |         |
| 550 mm | 65x42 mm | 1 | 5515FUV |

Magnifying Small and Light Mirrors 18 mm



**5515L**

|        |       |   |       |
|--------|-------|---|-------|
|        |       |   |       |
| 160 mm | 21 mm | 1 | 5515L |

Optical Magnifiers 90 mm x 30 mm



**3046-OP**

|        |    |         |
|--------|----|---------|
|        |    |         |
| 105 mm | 12 | 3046-OP |

Plastic Repair Mirrors



**5515B**

|        |         |    |       |
|--------|---------|----|-------|
|        |         |    |       |
| 220 mm | 28.5 mm | 25 | 5515B |

Swivel Head Telescopic Pocket Mirrors



**5515T**

|            |       |    |       |
|------------|-------|----|-------|
|            |       |    |       |
| 180-690 mm | 30 mm | 25 | 5515T |





**BAHCO**



## Extractors & Pullers



## MECHANICAL

### 2-Arm Universal Pullers with Induction Hardened Spindle and Galvanized Finish



#### 4532

| 25-80 mm   | 100 mm | 1 |  |  | 4532-A    |
|------------|--------|---|--|--|-----------|
| 25-80 mm   | 200 mm | 1 |  |  | 4532-AL   |
| 25-130 mm  | 100 mm | 1 |  |  | 4532-B    |
| 25-130 mm  | 200 mm | 1 |  |  | 4532-BL   |
| 50-160 mm  | 150 mm | 1 |  |  | 4532-C    |
| 50-160 mm  | 300 mm | 1 |  |  | 4532-CL   |
| 60-200 mm  | 150 mm | 1 |  |  | 4532-D    |
| 80-250 mm  | 200 mm | 1 |  |  | 4532-E    |
| 80-350 mm  | 200 mm | 1 |  |  | 4532-F    |
| 110-520 mm | 200 mm | 1 |  |  | 4532-G    |
| 110-520 mm | 300 mm | 1 |  |  | 4532-G-SO |
| 170-640 mm | 225 mm | 1 |  |  | 4532-H    |

4532/B: Spare body 4532K: Pair of spare arms 4532LK: Pair of long spare arms 4532/S: Spare spindles

### Pair of Spare Arm for 4532 Extractor



#### 4532K-4532LK

| 4532-A, 4532-B                    | 100 mm | 1 |  |  | 4532K1  |
|-----------------------------------|--------|---|--|--|---------|
| 4532-C, 4532-D                    | 150 mm | 1 |  |  | 4532K2  |
| 4532-E, 4532-F, 4532-G            | 200 mm | 1 |  |  | 4532K3  |
| 4532-H                            | 225 mm | 1 |  |  | 4532K4  |
| 4532-AL, 4532-BL                  | 200 mm | 1 |  |  | 4532LK1 |
| 4532-CL                           | 300 mm | 1 |  |  | 4532LK2 |
| 4532-G-SO                         | 300 mm | 1 |  |  | 4532LK3 |
| 4532-E, 4532-F, 4532-G, 4532-G-SO | 400 mm | 1 |  |  | 4532LK4 |
| 4532-E, 4532-F, 4532-G, 4532-G-SO | 500 mm | 1 |  |  | 4532LK5 |

### Spindle for 4532 Puller



#### 4532-S

| 4532-0, 4532-A, 4532-AL, 4532-B, 4532-BL |  | 1 |  |  | 4532-OAB/S |
|--|--|---|--|--|------------|
| 4532-C, 4532-CL, 4532-D                  |  | 1 |  |  | 4532-CD/S  |
| 4532-E, 4532-F, 4532-G, 4532-G-SO        |  | 1 |  |  | 4532-EFG/S |
| 4532-H                                   |  | 1 |  |  | 4532-H/S   |

### 2-Arm Universal Pullers with Galvanized Finish



#### 4532-0

| 20-90 mm | 100 mm | 1 |  |  | 4532-0 |
|----------|--------|---|--|--|--------|

4532-0/B: Spare body 4532K0: Pair of spare arms

### 2-Arm Universal Pullers with Long Arms/ Spindle and Galvanized Finish



#### 3115

| 80-250 mm | 300 mm | 1 |  |  | 3115 |
|-----------|--------|---|--|--|------|

### 2-Arm Universal Puller Set Displays with Galvanized Finish



#### 4532ST/5

| 16700 g |  | 1 |  |  | 4532ST/5 |
|---------|--|---|--|--|----------|

4532-A, 4532-B, 4532-C, 4532-D, 4532-E

### 3-Leg and Multi Arm Pullers



#### 4533

| 150-700 mm | 185 mm | 1 |  |  | 4533HP   |
|------------|--------|---|--|--|----------|
| 150-700 mm | 200 mm | 1 |  |  | 4533M    |
|            | 185 mm | 1 |  |  | 4533HPK  |
|            | 200 mm | 1 |  |  | 4533MK   |
|            |        | 1 |  |  | 4533HP/S |
|            |        | 1 |  |  | 4533M/S  |

4533HP: hydraulic 4533M: mechanical 4533/S: Spare spindle 4533/K: Set of 3 spare arms

### Hydraulic Rams with Galvanized Finish



#### 4529

| 8 to 15 to | $T_n$<br>max |   |  |  |         |
|------------|--------------|---|--|--|---------|
|            | 60 N·m       | 1 |  |  | 4529-8  |
|            | 70 N·m       | 1 |  |  | 4529-15 |

### 3-Arm Hydraulic Extractors



#### 4528

| 50-350 mm | 135 mm | 1 | 4528-1 |  |  |
|-----------|--------|---|--------|--|--|

4528K: Set of 3 spare arms 4528/B: Spare body 4533HP/S: Spare hydraulic spindle

### 2-Arm Heavy Duty Pullers with Galvanized Finish



#### 4544

| 10-100 mm | 80 mm  | 1 | 4544-1     |  |  |
|-----------|--------|---|------------|--|--|
| 10-120 mm | 120 mm | 1 | 4544-2     |  |  |
| 20-160 mm | 160 mm | 1 | 4544-3     |  |  |
| 20-200 mm | 200 mm | 1 | 4544-4     |  |  |
|           |        | 1 | 4544-110/S |  |  |
|           |        | 1 | 4544-220/S |  |  |
|           |        | 1 | 4519-1/S   |  |  |
|           |        | 1 | 4544-440/S |  |  |

4544-1/4: w/2 arms 4544-10/30: w/3 arms 4544/B: spare body 4544K: spare arm 4544/S: spare spindle

### 3-Arm Heavy Duty Pullers with Galvanized Finish



#### 4544-

| 10-100 mm | 80 mm  | 1 | 4544-10 |  |  |
|-----------|--------|---|---------|--|--|
| 10-120 mm | 120 mm | 1 | 4544-20 |  |  |
| 20-160 mm | 160 mm | 1 | 4544-30 |  |  |

### 2-Arm Heavy Duty Pullers with Galvanized Finish



#### 4543

| 10-60 mm | 40 mm | 1 | 4543-1   |  |  |
|----------|-------|---|----------|--|--|
| 10-70 mm | 74 mm | 1 | 4543-2   |  |  |
| 10-90 mm | 84 mm | 1 | 4543-3   |  |  |
|          |       | 1 | 4543-1/S |  |  |
|          |       | 1 | 4543-2/S |  |  |
|          |       | 1 | 4543-3/S |  |  |

4543-1/3: w/2 arms 4543-10/30: w/3 arms 4543/B: Spare body 4543K: Spare arm 4543/S: Spare spindle

### 3-Arm Light Duty Pullers with Galvanized Finish



#### 4543-

| 10-60 mm | 40 mm | 1 | 4543-10 |  |  |
|----------|-------|---|---------|--|--|
| 10-70 mm | 74 mm | 1 | 4543-20 |  |  |
| 10-90 mm | 84 mm | 1 | 4543-30 |  |  |

### 2-Arm Pullers with Galvanized Finish



#### 4541

| 20-150 mm | 85 mm  | 1 | 4541-A |  |  |
|-----------|--------|---|--------|--|--|
| 40-220 mm | 130 mm | 1 | 4541-B |  |  |

4541/B: Spare body 4541K: Spare arm 4532-4519/S: Spare spindle

### 3-Arm Pullers with Galvanized Finish



#### 4542

| 20-150 mm | 85 mm  | 1 | 4542-A |  |  |
|-----------|--------|---|--------|--|--|
| 40-220 mm | 130 mm | 1 | 4542-B |  |  |

4542/B: Spare body 4541K: Spare arm 4532-4519/S: Spare spindle

### 2-Arm Puller with Galvanized Finish



#### 4537

| 20-170 mm | 130 mm | 1 | 4537-1 |  |  |
|-----------|--------|---|--------|--|--|
| 20-230 mm | 200 mm | 1 | 4537-2 |  |  |
| 50-300 mm | 250 mm | 1 | 4537-3 |  |  |
| 50-350 mm | 350 mm | 1 | 4537-4 |  |  |

4537/B: Spare body 4537K: Spare arm 4532-4519/S: Spare spindle

### 3-Arm Pullers for 4528M1/4528M2/4528M3 Extractors



#### 4528M

| 20-170 mm | 130 mm | 1 | 4528M1 |  |  |
|-----------|--------|---|--------|--|--|
| 20-230 mm | 200 mm | 1 | 4528M2 |  |  |
| 50-300 mm | 250 mm | 1 | 4528M3 |  |  |
| 50-350 mm | 350 mm | 1 | 4528M4 |  |  |
| 50-400 mm | 400 mm | 1 | 4528M5 |  |  |

4528M/B: Spare body 4537K-4528MK: Spare arm 4532/S-4519/S: Spare spindle





## 2-Arm Pullers with Clamp and Galvanized Finish



### 4519

| Icon 1    |           | Icon 2 |        | Icon 3 |  |
|-----------|-----------|--------|--------|--------|--|
| 20-110 mm | 80-170 mm | 1      | 4519-1 |        |  |
| 40-150 mm | 90-270 mm | 1      | 4519-2 |        |  |
| 40-150 mm | 90-330 mm | 1      | 4519-3 |        |  |

4519/B: spare body 4519K: spare arm 4519/S: spare spindle

## Scissor-Type Pullers with Galvanized Finish



### 4614

| Icon 1    |           | Icon 2 |        | Icon 3 |  |
|-----------|-----------|--------|--------|--------|--|
| 6-100 mm  | 70-85 mm  | 1      | 4614-1 |        |  |
| 10-140 mm | 85-120 mm | 1      | 4614-2 |        |  |

4614/B: spare body 4614K: pair of spare arms 4543-4532/S: spare spindle

## Multiple Extractors - 5 Pcs



### 4540

| Icon 1    |           | Icon 2 |           | Icon 3 |  |
|-----------|-----------|--------|-----------|--------|--|
| 30-170 mm | 65-140 mm | 1      | 4540-17   |        |  |
|           |           | 1      | 4540-17/S |        |  |
| 75-250 mm | 77-180 mm | 1      | 4540-25   |        |  |
|           |           | 1      | 4540-25/S |        |  |

## Extractors for Separators



### 4552

| Icon 1   |  | Icon 2 |        | Icon 3 |  |
|----------|--|--------|--------|--------|--|
| 4551-A-B |  | 1      | 4552-1 |        |  |
| 4551-C   |  | 1      | 4552-2 |        |  |
| 4551-D   |  | 1      | 4552-3 |        |  |

4552/B: Spare body 4552K: Spare tie rod 4532/S: Spare spindle

## Separators with Galvanized Finish



### 4551

| Icon 1 |  | Icon 2 |        | Icon 3 |  |
|--------|--|--------|--------|--------|--|
| 4552-1 |  | 1      | 4551-A |        |  |
| 4552-1 |  | 1      | 4551-B |        |  |
| 4552-2 |  | 1      | 4551-C |        |  |
| 4552-3 |  | 1      | 4551-D |        |  |

4551/S: spare spindle

## Pullers and Separator Set with Galvanized Finish



### 4574

| Icon 1             |  | Icon 2 |      | Icon 3 |  |
|--------------------|--|--------|------|--------|--|
| 105 x 300 x 360 mm |  | 1      | 4574 |        |  |

4532-A, 4532-C

4532LK1, 4532LK2

4551-C

4529-15

## Ball Bearing Extractors without Arms



### 4581N-4583N

| Icon 1                  |  | Icon 2 |         | Icon 3 |  |
|-------------------------|--|--------|---------|--------|--|
| 4581NA, 4581NB          |  | 1      | 4581N-1 |        |  |
| 4581NB2, 4581NC, 4582NA |  | 1      | 4582N-1 |        |  |
| 4581NC, 4582NA, 4582NB  |  | 1      | 4582N-2 |        |  |
| 4582NA, 4583NA          |  | 1      | 4583N-1 |        |  |
| 4582NA, 4582NB, 4583NB  |  | 1      | 4583N-2 |        |  |

## Extractors Spare Arms Set



### 4581NA-4583NB

| Icon 1 |                                    | Icon 2 |         | Icon 3 |  |
|--------|------------------------------------|--------|---------|--------|--|
| 145 mm | 4581N-1                            | 1      | 4581NA  |        |  |
| 120 mm | 4581N-1                            | 1      | 4581NB  |        |  |
| 130 mm | 4582N-1                            | 1      | 4581NB2 |        |  |
| 130 mm | 4582N-1, 4582N-2                   | 1      | 4581NC  |        |  |
| 150 mm | 4582N-1, 4582N-2, 4583N-1, 4583N-2 | 1      | 4582NA  |        |  |
| 150 mm | 4582N-2, 4583N-2                   | 1      | 4582NB  |        |  |
| 190 mm | 4583N-1                            | 1      | 4583NA  |        |  |
| 235 mm | 4583N-2                            | 1      | 4583NB  |        |  |

## Ball Bearing Puller Set with Galvanized Finish



### 4580N/7

| Icon 1            |  | Icon 2 |         | Icon 3 |  |
|-------------------|--|--------|---------|--------|--|
| 66 x 192 x 287 mm |  | 1      | 4580N/7 |        |  |

4581N-1, 4582N-1, 4582N-2, 4583N-1, 4583N-2, 4581NA to 4583NB

Ball Bearing Extractor Set with Galvanized Finish



**4578**



75 x 235 x 285 mm

1 4578

4581N-1, 4582N-2, 4581NA, 4581NB, 4581NB2, 4581NC

Ball Bearing Internal Extractors with Gunmetal Finish



**4521N**



|           |   |          |
|-----------|---|----------|
| 5-7 mm    | 1 | 4521N-00 |
| 7-9 mm    | 1 | 4521N-0  |
| 9-12 mm   | 1 | 4521N-A  |
| 10-13 mm  | 1 | 4521N-B  |
| 13-17 mm  | 1 | 4521N-C  |
| 14-19 mm  | 1 | 4521N-D  |
| 16-21 mm  | 1 | 4521N-E  |
| 18-23 mm  | 1 | 4521N-F  |
| 20-25 mm  | 1 | 4521N-G  |
| 25-30 mm  | 1 | 4521N-H  |
| 30-37 mm  | 1 | 4521N-I  |
| 35-42 mm  | 1 | 4521N-K  |
| 38-45 mm  | 1 | 4521N-L  |
| 43-50 mm  | 1 | 4521N-M  |
| 40-75 mm  | 1 | 4521N-S  |
| 70-115 mm | 1 | 4521N-T  |

2-Arm Counter Stay Extractors with Galvanized Finish



**4522**



|           |   |        |
|-----------|---|--------|
| 35-75 mm  | 1 | 4522-1 |
| 60-130 mm | 1 | 4522-2 |

4522/B: Spare body 4522K: Spare arm 4522/S: Spare spindle

Sliding Hammer Pulling Bars with Gunmetal Finish



**4523G**



|            |   |       |
|------------|---|-------|
| Ø10x170 mm | 1 | 4523G |
|------------|---|-------|

Sliding Hammer Pulling Bars with Galvanized Finish



**4524G**



|              |   |       |
|--------------|---|-------|
| Ø16 x 250 mm | 1 | 4524G |
|--------------|---|-------|

Complete Workshop Puller Assortment Set - 9 Pcs



**4521N/7**



|                   |        |   |         |
|-------------------|--------|---|---------|
| 95 x 360 x 310 mm | 6800 g | 1 | 4521N/7 |
|-------------------|--------|---|---------|

4521N-B, 4521N-D, 4521N-H, 4521N-I, 4521N-L, 4521N-S, 4521N-G

4522-2, 4522-1

Universal Ball Joint Pullers with Galvanized Finish



**4545-N**



|           |          |   |          |
|-----------|----------|---|----------|
| Max 50 mm | 18-22 mm | 1 | 4545-N1  |
| Max 90 mm | 27-36 mm | 1 | 4545-N11 |
| Max 50 mm | 26 mm    | 1 | 4545-N2  |
| 60-80 mm  | 26 mm    | 1 | 4545-N21 |

4545/S: Spare spindle

Universal Hub Pullers with Galvanized Finish



**4518**



|        |        |   |        |
|--------|--------|---|--------|
| 225 mm | 140 mm | 1 | 4518-3 |
| 225 mm | 140 mm | 1 | 4518-4 |
| 225 mm | 140 mm | 1 | 4518-5 |



Ball Joint Extractors with Galvanized Finish



**4545**

|       |   |        |
|-------|---|--------|
|       |   |        |
| 18 mm | 1 | 4545-1 |
| 25 mm | 1 | 4545-2 |
| 29 mm | 1 | 4545-3 |
| 40 mm | 1 | 4545-4 |
| 45 mm | 1 | 4545-5 |

Internal and External Extractor with Sliding Hammer Set



**4590SHS5**

|                   |   |          |
|-------------------|---|----------|
|                   |   |          |
| 79 x 230 x 500 mm | 4 | 4590SHS5 |

Mechanical Nut Splitters with Galvanised and Gunmetal Finish



**4611**

|        |   |        |
|--------|---|--------|
|        |   |        |
| to M16 | 1 | 4611-2 |
| to M24 | 1 | 4611-3 |

4611/S: spare spindles 4611/B: spare blades

Extractors Set for Car Maintenance



**4577**

|                   |   |      |
|-------------------|---|------|
|                   |   |      |
| 70 x 340 x 425 mm | 1 | 4577 |

|  |  |
|--|--|
| 4545-N2  |  |
| 4532-B   |  |
| 4614-1   |  |
| 4521N-D, 4521N-B, 4521N-H, 4521N-I, 4521N-G, 4521N-L |  |
| 4522-1   |  |

Mini Puller Set with Galvanized Finish



**4579**

|                   |   |      |
|-------------------|---|------|
|                   |   |      |
| 65 x 210 x 275 mm | 1 | 4579 |

4543-2, 4543-3, 4543-1020/B, 4543-30/B, 4543K220, 4543K330

Stud Removers with Chromed Plated



**4553**

|         |   |      |
|---------|---|------|
|         |   |      |
| 5-20 mm | 1 | 4553 |

Stud Removers with Galvanised and Gunmetal Finish



**4591-4593**

|          |   |      |
|----------|---|------|
|          |   |      |
| 10-19 mm | 1 | 4592 |
| 5-15 mm  | 1 | 4591 |
| 18-28 mm | 1 | 4593 |

Hydraulic Nut Splitters with Galvanised and Gunmetal Finish



**4610**

|        |   |        |
|--------|---|--------|
|        |   |        |
| M4-M14 | 1 | 4610-1 |

Stud Extractors Rolled Thread



**1420-1424**

| Item   | Quantity | Part Number |
|--------|----------|-------------|
| M 3-6  | 1        | 1420-1.4    |
| M 6-8  | 1        | 1421-2.1    |
| M 8-11 | 1        | 1422-3.1    |
| M11-14 | 1        | 1423-4.8    |
| M14-18 | 1        | 1424-6.2    |

Stud Extractors - 5 Pcs



**1435/5**

| Dimensions      | Weight | Quantity | Part Number |
|-----------------|--------|----------|-------------|
| 15 x 50 x 90 mm | 110 g  | 1        | 1435/5      |

1423-4.8, 1420-1.4, 1422-3.1, 1421-2.1, 1424-6.2

Stud Extractors - 8 Pcs



**1435/8**

| Dimensions        | Weight | Quantity | Part Number |
|-------------------|--------|----------|-------------|
| 29 x 110 x 118 mm | 700 g  | 1        | 1435/8      |

1420-1.4, 1421-2.1, 1422-3.1, 1423-4.8, 1424-6.2

Stud Extractors for Broken-Off Screws/  
Bolts/Studs M5-M24



**1419-M5/1419-M16**

| Item    | Quantity | Part Number |
|---------|----------|-------------|
| M5-M10  | 1        | 1419-M5     |
| M8-M14  | 1        | 1419-M8     |
| M12-M20 | 1        | 1419-M12    |
| M16-M24 | 1        | 1419-M16    |

Stud Extractor Set for Broken-Off Screws/  
Bolts/Studs - 4 Pcs



**1419/4**

| Item   | Weight | Quantity | Part Number |
|--------|--------|----------|-------------|
| M5-M24 | 430 g  | 1        | 1419/4      |

M5-M10; M8-M14; M12-M20; M16-M24

Multi Spine Extractors Set - 15 Pcs



**BWMSP15**

| Dimensions       | Weight  | Quantity | Part Number |
|------------------|---------|----------|-------------|
| 43 x 90 x 200 mm | 0.54 kg | 1        | BWMSP15     |

Stud Extraction Bits with Blasted Finish



**BWMSP15**

| Item    | Quantity | Part Number |
|---------|----------|-------------|
| 3 mm    | 1        | BWMSP1501   |
| 4 mm    | 1        | BWMSP1502   |
| 5 mm    | 1        | BWMSP1503   |
| 5.5 mm  | 1        | BWMSP1504   |
| 6 mm    | 1        | BWMSP1505   |
| 8 mm    | 1        | BWMSP1506   |
| 10 mm   | 1        | BWMSP1507   |
| 1/8 in  | 1        | BWMSP1508   |
| 3/16 in | 1        | BWMSP1509   |
| 1/4 in  | 1        | BWMSP1510   |
| 3/8 in  | 1        | BWMSP1511   |
| 11 mm   | 1        | BWMSP1512   |
| 12 mm   | 1        | BWMSP1513   |
| 14 mm   | 1        | BWMSP1514   |
| 1/2 in  | 1        | BWMSP1515   |

Stud Extractors for Broken-Off Screws/  
Bolts/Studs M5-M16



**1418S**

| Dimensions               | Quantity | Part Number |
|--------------------------|----------|-------------|
| 25 x 127 x 162 mm M6-M16 | 1        | 1418S       |

1418-4, 1418-5, 1418-6, 1418-7.5, 1418-8.5



Stud Extractors with Alloy Steel



**1418**

|         |   |          |
|---------|---|----------|
|         |   |          |
| M5-M8   | 1 | 1418-4   |
| M8-M10  | 1 | 1418-5   |
| D11-M12 | 1 | 1418-6   |
| M12-M14 | 1 | 1418-7.5 |
| M14-M16 | 1 | 1418-8.5 |

Flat Head Pinch Bars with Flat Shank



**3680**

|        |   |      |
|--------|---|------|
|        |   |      |
| 400 mm | 1 | 3680 |

Flat Head Pry Bar with Through Blade for Hammering



**2484T-20/2484T-60**

|        |   |          |
|--------|---|----------|
|        |   |          |
| 210 mm | 1 | 2484T-20 |
| 312 mm | 1 | 2484T-30 |
| 450 mm | 1 | 2484T-45 |
| 600 mm | 1 | 2484T-60 |

**PRY BARS**

Combination Pinch Bars with Hexagon Shank



**2632**

|        |   |      |
|--------|---|------|
|        |   |      |
| 170 mm | 1 | 2632 |

Flat Head Pry Bars with PP Handle



**2484-20/2484-60**

|        |   |         |
|--------|---|---------|
|        |   |         |
| 205 mm | 1 | 2484-20 |
| 305 mm | 1 | 2484-30 |
| 465 mm | 1 | 2484-45 |
| 615 mm | 1 | 2484-60 |

4 pcs Flat Head Pry Bars with Through Blade for Hammering



**2484T/S4**

|                   |        |   |          |
|-------------------|--------|---|----------|
|                   |        |   |          |
| 42 x 145 x 693 mm | 1950 g | 1 | 2484T/S4 |

Flat Head Pinch Bars with Hexagon Shank



**3684**

|        |   |         |
|--------|---|---------|
|        |   |         |
| 406 mm | 1 | 3684-16 |
| 457 mm | 1 | 3684-18 |
| 609 mm | 1 | 3684-24 |
| 760 mm | 1 | 3684-30 |

Flat Head Pry Bar Set with PP Handle



**2484/S4**

|                   |    |         |
|-------------------|----|---------|
|                   |    |         |
| 42 x 145 x 693 mm | 10 | 2484/S4 |

Rolling Head Pry Bar



**3683**

|        |   |      |
|--------|---|------|
|        |   |      |
| 400 mm | 1 | 3683 |

2484-20, 2484-30, 2484-45, 2484-60



Rolling Head Pry Bars with Phosphated Body



**3681**



|        |   |         |
|--------|---|---------|
| 304 mm | 1 | 3681-11 |
| 406 mm | 1 | 3681-16 |
| 503 mm | 1 | 3681-20 |

## PICKING TOOLS

ERGO™ Neodymium Magnetic Pick-Up Tool 4 mm x 290 mm



ergo®

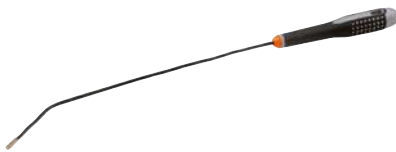

**2535F0**



|        |        |   |        |
|--------|--------|---|--------|
| 5.5 mm | 515 mm | 1 | 2535F0 |
|--------|--------|---|--------|

BahcoFit Flexible Magnetic Pullers with Rubber Grip 10-18 mm



**B147**



|       |        |   |              |
|-------|--------|---|--------------|
| 13 mm | 400 mm | 1 | B147.001.400 |
| 19 mm | 400 mm | 1 | B147.003.400 |

Magnetic pick-up ERGO™



ergo®



**2535F**



|       |        |   |        |
|-------|--------|---|--------|
| 10 mm | 400 mm | 1 | 2535F1 |
| 10 mm | 400 mm | 1 | 2535F2 |
| 17 mm | 400 mm | 1 | 2535F3 |

Magnetic pick-up tool with light



**2535L**



|       |           |    |       |
|-------|-----------|----|-------|
| 20 mm | 40-670 mm | 12 | 2535L |
|-------|-----------|----|-------|

Flexible Pick-Up Tools with Steel Core



**2509**



|        |    |      |
|--------|----|------|
| 555 mm | 50 | 2509 |
|--------|----|------|

Claw Pick-Up Tools with Steel Core



**2530**



|        |   |      |
|--------|---|------|
| 605 mm | 1 | 2530 |
|--------|---|------|

## THREAD TOOLS

Thread Cutting Toolset - 37 Pcs



**1460M/1**



|                   |        |   |         |
|-------------------|--------|---|---------|
| 53 x 407 x 220 mm | M5-M12 | 1 | 1460M/1 |
|-------------------|--------|---|---------|

Thread Cutting Toolset - 55 Pcs



**1460M/2**



|                   |        |   |         |
|-------------------|--------|---|---------|
| 53 x 407 x 220 mm | M5-M20 | 1 | 1460M/2 |
|-------------------|--------|---|---------|



Thread Cutting Toolset - 54 Pcs



**1460Z/2**



53 x 407 x 220 mm 1/4-3/4

1 1460Z/2

Tap Wrenches with Chrome Finish



**600**



3-10 mm 1 600.003.010  
5-12 mm 1 600.005.012

Metric Double Thread Restorers



**1450D-ISO**



230 mm 1 1450D-ISO

Imperial Double Thread Restorers



**1450D-WW**



230 mm 1 1450D-WW

Double Thread Restorers Set in Wooden Box



**1450D/2**



40 x 70 x 270 mm M5-M27 1 1450D/2

1450D-ISO

1450D-WW



## Tool Storage & Toolkits



# TOOL TROLLEYS

53" Tool Trolley General Purpose Tool Kit  
- 488 Pcs



**XXL**



986 x 501 x 1430 mm



1 XXL

|   |  |
|---|--|
| 1476KXXL7BK   |  |
| 2058-BR   |  |
| 6700SM-10, 6700SM-11, 6700SM-12, 6700SM-13, 6700SM-14, 6700SM-4, 6700SM-4.5, 6700SM-5, 6700SM-5.5, 6700SM-6, 6700SM-7, 6700SM-8, 6700SM-9   |  |
| 6700TORX-E10, 6700TORX-E4, 6700TORX-E5, 6700TORX-E6, 6700TORX-E7, 6700TORX-E8   |  |
| 6950SL  |  |
| 6954  |  |
| 6956  |  |
| 6960, 6962, 6962L, 696EX-11   |  |
| 6963  |  |
| 6966  |  |
| 6972H   |  |
| 7400SM-10, 7400SM-11, 7400SM-12, 7400SM-13, 7400SM-14, 7400SM-15, 7400SM-16, 7400SM-17, 7400SM-18, 7400SM-19, 7400SM-20, 7400SM-21, 7400SM-22, 7400SM-6, 7400SM-7, 7400SM-8, 7400SM-9 |  |
| 7400TORX-E10, 7400TORX-E11, 7400TORX-E12, 7400TORX-E14, 7400TORX-E16, 7400TORX-E18, 7400TORX-E8   |  |
| 7406ZZ-16, 7406ZZ-21  |  |
| 7409BH-10, 7409BH-4, 7409BH-5, 7409BH-6, 7409BH-8   |  |
| 7409F-10, 7409F-6.5, 7409F-8  |  |
| 7409TORX-R-T27, 7409TORX-R-T30, 7409TORX-R-T40, 7409TORX-R-T45, 7409TORX-R-T50  |  |
| 7409TORX-T25, 7409TORX-T27, 7409TORX-T30, 7409TORX-T40, 7409TORX-T45, 7409TORX-T50  |  |
| 7750SL  |  |
| 7757, K6650-1/4-1P  |  |
| 7758  |  |
| 7759  |  |
| 7760  |  |

|   |  |
|---|--|
| 7761-W  |  |
| 7764  |  |
| 7765  |  |
| 7766  |  |
| 7767  |  |
| 776EX-11  |  |
| 7800SM-10, 7800SM-11, 7800SM-12, 7800SM-13, 7800SM-14, 7800SM-15, 7800SM-16, 7800SM-17, 7800SM-18, 7800SM-19, 7800SM-20, 7800SM-21, 7800SM-22, 7800SM-23, 7800SM-24, 7800SM-25, 7800SM-26, 7800SM-27, 7800SM-28, 7800SM-29, 7800SM-30, 7800SM-32, 7800SM-33, 7800SM-34, 7800SM-36, 7800SM-8, 7800SM-9 |  |
| 7800TORX-E10, 7800TORX-E11, 7800TORX-E12, 7800TORX-E14, 7800TORX-E16, 7800TORX-E18, 7800TORX-E20, 7800TORX-E24, 7800TORX-E8   |  |
| 7805SM-10, 7805SM-12, 7805SM-13, 7805SM-14, 7805SM-15, 7805SM-16, 7805SM-17, 7805SM-18, 7805SM-19, 7805SM-20, 7805SM-21, 7805SM-22, 7805SM-23, 7805SM-24, 7805SM-25, 7805SM-26, 7805SM-27, 7805SM-28, 7805SM-29, 7805SM-30, 7805SM-32   |  |
| 7809M-10, 7809M-12, 7809M-14, 7809M-4, 7809M-5, 7809M-6, 7809M-7, 7809M-8   |  |
| 7809M-10-140, 7809M-5-100, 7809M-6-100, 7809M-7-100, 7809M-8-120  |  |
| 7809XZN-10, 7809XZN-10-100, 7809XZN-12, 7809XZN-12-100, 7809XZN-14, 7809XZN-14-100, 7809XZN-16, 7809XZN-18, 7809XZN-6, 7809XZN-8, 7809XZN-100   |  |
| 8150SL  |  |
| 8160-3, 8160-5  |  |
| 8160W-10  |  |
| 8164-1/2  |  |
| 8171  |  |
| 8166  |  |
| 8167  |  |
| A6800DM-10, A6800DM-11, A6800DM-12, A6800DM-13, A6800DM-14, A6800DM-4, A6800DM-5, A6800DM-5.5, A6800DM-6, A6800DM-7, A6800DM-8, A6800DM-9   |  |
| A7402DM-10, A7402DM-11, A7402DM-12, A7402DM-13, A7402DM-14, A7402DM-15, A7402DM-16, A7402DM-17, A7402DM-18, A7402DM-19, A7402DM-21, A7402DM-21, A7402DM-7, A7402DM-8, A7402DM-9   |  |
| K6625-1/4-1P  |  |
| K6650-1/2-1P, K6650-3/8-1P  |  |
| 2101G-160   |  |
| 2421 G-140IP, 2421 G-180  |  |
| 2427 G-200  |  |
| 2430 G-160  |  |
| 2628 G-180  |  |
| 2800-140, 2800-180, 2800-225  |  |
| 2890-125, 2890-180, 2890-210  |  |
| 2900-140, 2900-180, 2900-215  |  |
| 2951-250  |  |
| 2952-165  |  |
| 2990-140, 2990-180, 2990-200  |  |
| 3416 A  |  |
| 4130  |  |
| 7224  |  |

|   |  |
|---|--|
| BE256-155, BE256-178, BE256-250   |  |
| BLTS7P  |  |
| CR W 01   |  |
| 1150-1/2H/P   |  |
| 1544  |  |
| 2633/S4x 4  |  |
| 59/S100BCx 100  |  |
| 806-1-3   |  |
| 808050L   |  |
| BE-7607   |  |
| BE-8020L  |  |
| BE-8155TB, BE-8256TB, BE-8258TB   |  |
| BE-8355   |  |
| BE-8600   |  |
| BE-8602   |  |
| BE-8610TB, BE-8620TB, BE-8623TB, BE-8624TB  |  |
| BE-8802   |  |
| BE-8810TB, BE-8820TB, BE-8823TB, BE-8824TB  |  |
| BE-8907, BE-8908, BE-8909, BE-8910, BE-8915, BE-8920, BE-8925, BE-8927, BE-8930, BE-8940  |  |
| BE-8986   |  |
| BE-9770x 9  |  |
| BE-9785x 13   |  |
| MTC-5-16-C1   |  |
| 1-170-08-2-2  |  |
| 1-210-08-2-2  |  |
| 1-230-08-2-2  |  |
| 208   |  |
| 2484T-30, 2484T-60  |  |
| 2509  |  |
| 2535L   |  |
| 319   |  |
| 3625N-32  |  |
| 3681-16   |  |
| 3734-2, 3734-3, 3734-4, 3734-5, 3734-6, 3734-8  |  |
| 3735-4-120, 3735-5-120  |  |
| 3740-150, 3740-250  |  |
| 3906-300-32-5Px 5   |  |
| 479-08  |  |
| 481-1000, 481-400   |  |
| 5515T   |  |
| 782-U   |  |
| KBGU-5P-DISPENx 5   |  |
| KERU-01   |  |
| 111M-10, 111M-11, 111M-12, 111M-13, 111M-14, 111M-15, 111M-16, 111M-17, 111M-18, 111M-19, 111M-20, 111M-21, 111M-22, 111M-23, 111M-24, 111M-25, 111M-26, 111M-27, 111M-28, 111M-29, 111M-30, 111M-32, 111M-33, 111M-34, 111M-36, 111M-6, 111M-7, 111M-8, 111M-9 |  |
| 1RM-10, 1RM-11, 1RM-12, 1RM-13, 1RM-14, 1RM-15, 1RM-16, 1RM-17, 1RM-18, 1RM-19, 1RM-21, 1RM-22, 1RM-24, 1RM-27, 1RM-30, 1RM-32, 1RM-6, 1RM-7, 1RM-8, 1RM-9  |  |
| 4040M-10-11, 4040M-12-13, 4040M-14-15, 4040M-16-17, 4040M-18-19, 4040M-8-9  |  |
| 8069, 8071, 8073  |  |

Tool Trolley General Purpose Tool Kit - 758 pcs



**MONSTER**



1370 x 501 x 1100 mm

1 MONSTER

FF1BSET-MONSTER

Tool Trolley Auto Repair Tool Kit - 357 pcs



**AUTO**



976 x 510 x 820 mm

1 AUTO

FF1ASET-AUTO

Tool Trolley General Purpose Tool Kit - 158 pcs



**BASIC1**



952 x 510 x 782 mm

1 BASIC

FF1ASET-BASIC

Tool Trolley General Purpose Tool Kit - 560 pcs



**XLARGE**



1360 x 510 x 820 mm

1 XLARGE

FF1ASET-XLARGE

Tool Trolley General Purpose Tool Kit - 346 pcs



**LARGE**



952 x 510 x 782 mm

1 LARGE

FF1ASET-LARGE

Tool Trolley General Purpose Tool Kit - 187 pcs



**1475KXL6CBK-FF6**



986 x 501 x 1100 mm

1 1475KXL6CBK-FF6

FF1A65



FF1A66



FF1A67



FF1A68



FF1A194





Tool Trolley General Purpose Tool Kit - 210 pcs



**1475KXL6CBK-FF5**



986 x 501 x 1100 mm

1 1475KXL6CBK-FF5

|         |  |  |
|---------|--|--|
| FF1A48  |  |  |
| FF1A49  |  |  |
| FF1A50  |  |  |
| FF1A51  |  |  |
| FF1A213 |  |  |
| FF1A53  |  |  |

26" E77 Premium Storage HUB Tool Trolleys with 9 Drawers



**1477K9**



976 x 510 x 820 mm  
 976 x 510 x 820 mm  
 976 x 510 x 820 mm  
 976 x 510 x 820 mm  
 976 x 510 x 820 mm

1 1477K9  
 1 1477K9BLACK  
 1 1477K9GREY  
 1 1477K9WHITE  
 1 1477K9RED

26" E77 Premium Storage HUB Tool Trolleys with 8 Drawers



**1477K8**



976 x 510 x 820 mm  
 976 x 510 x 820 mm

1 1477K8  
 1 1477K8BLACK



976 x 510 x 820 mm  
 976 x 510 x 820 mm  
 976 x 510 x 820 mm

1 1477K8GREY  
 1 1477K8WHITE  
 1 1477K8RED

26" E77 Premium Storage HUB Tool Trolleys with 7 Drawers



**1477K7**



976 x 510 x 820 mm  
 976 x 510 x 820 mm  
 976 x 510 x 820 mm  
 976 x 510 x 820 mm  
 976 x 510 x 820 mm

1 1477K7  
 1 1477K7BLACK  
 1 1477K7GREY  
 1 1477K7WHITE  
 1 1477K7RED

26" E77 Premium Storage HUB Tool Trolleys with 6 Drawers



**1477K6**



976 x 510 x 820 mm  
 976 x 510 x 820 mm  
 976 x 510 x 820 mm  
 976 x 510 x 820 mm  
 976 x 510 x 820 mm

1 1477K6  
 1 1477K6BLACK  
 1 1477K6GREY  
 1 1477K6WHITE  
 1 1477K6RED

Premium E87 Storage HUB Top Chests with 4-Drawers



**1487K4**



402 x 510 x 692 mm  
 402 x 510 x 692 mm  
 402 x 510 x 692 mm

1 1487K4  
 1 1487K4BLACK  
 1 1487K4GREY

Premium E87 Storage HUB Top Chests on Wheels with 4 Drawers



**1487K4W**



564 x 510 x 692 mm  
 564 x 510 x 692 mm

1 1487K4W  
 1 1487K4BKW

26" E72 Storage HUB Tool Trolleys with 8 Drawers



**1472K8**



952 x 510 x 782 mm  
 952 x 510 x 782 mm  
 952 x 510 x 782 mm  
 952 x 510 x 782 mm  
 952 x 510 x 782 mm  
 952 x 510 x 782 mm

1 1472K8  
 1 1472K8BLACK  
 1 1472K8GREY  
 1 1472K8WHITE  
 1 1472K8RED  
 1 1472K8BLUE

26" E72 Storage HUB Tool Trolleys with 7 Drawers



**1472K7**



|                    |   |             |
|--------------------|---|-------------|
| 952 x 510 x 782 mm | 1 | 1472K7      |
| 952 x 510 x 782 mm | 1 | 1472K7BLACK |
| 952 x 510 x 782 mm | 1 | 1472K7GREY  |
| 952 x 510 x 782 mm | 1 | 1472K7WHITE |
| 952 x 510 x 782 mm | 1 | 1472K7RED   |
| 952 x 510 x 782 mm | 1 | 1472K7BLUE  |

26" E72 Storage HUB Tool Trolleys with 5 Drawers



**1472K5**



|                    |   |             |
|--------------------|---|-------------|
| 952 x 510 x 782 mm | 1 | 1472K5      |
| 952 x 510 x 782 mm | 1 | 1472K5BLACK |
| 952 x 510 x 782 mm | 1 | 1472K5GREY  |
| 952 x 510 x 782 mm | 1 | 1472K5WHITE |
| 952 x 510 x 782 mm | 1 | 1472K5RED   |
| 952 x 510 x 782 mm | 1 | 1472K5BLUE  |

26" E72 Storage HUB Top Chests with 4 Drawers



**1482K4W**



|                    |   |           |
|--------------------|---|-----------|
| 542 x 515 x 699 mm | 1 | 1482K4W   |
| 542 x 515 x 699 mm | 1 | 1482K4BKW |

26" E72 Storage HUB Tool Trolleys with 6 Drawers



**1472K6**



|                    |   |             |
|--------------------|---|-------------|
| 952 x 510 x 782 mm | 1 | 1472K6      |
| 952 x 510 x 782 mm | 1 | 1472K6BLACK |
| 952 x 510 x 782 mm | 1 | 1472K6GREY  |
| 952 x 510 x 782 mm | 1 | 1472K6WHITE |
| 952 x 510 x 782 mm | 1 | 1472K6RED   |
| 952 x 510 x 782 mm | 1 | 1472K6BLUE  |

26" E72 Storage HUB Top Chests with 4 Drawers



**1482K4**



|                    |   |             |
|--------------------|---|-------------|
| 386 x 510 x 692 mm | 1 | 1482K4      |
| 386 x 510 x 692 mm | 1 | 1482K4BLACK |
| 386 x 510 x 692 mm | 1 | 1482K4GREY  |
| 386 x 510 x 692 mm | 1 | 1482K4WHITE |
| 386 x 510 x 692 mm | 1 | 1482K4RED   |
| 386 x 510 x 692 mm | 1 | 1482K4BLUE  |

Top Tool Panels for 1477K Storage HUB Tool Trolleys



**1477K-AC12**



|                   |   |            |
|-------------------|---|------------|
| 396 x 25 x 610 mm | 1 | 1477K-AC12 |
|-------------------|---|------------|

26" E72 Storage HUB Top Chests on Wheels with 5 Drawers



**1482K5W**



|                    |   |         |
|--------------------|---|---------|
| 542 x 515 x 699 mm | 1 | 1482K5W |
|--------------------|---|---------|

Top Side Tool Panels for 1477K Storage HUB Tool Trolleys



**1477K-AC13**



|                   |   |            |
|-------------------|---|------------|
| 400 x 25 x 365 mm | 1 | 1477K-AC13 |
|-------------------|---|------------|



Work Document Boards for 1477K Storage HUB Tool Trolleys



**1477K-AC14**



327 x 25 x 240 mm

1 1477K-AC14

Jacket Holders for 1477K Storage HUB Tool Trolleys



**1477K-AC17**



68 x 65 x 435 mm

1 1477K-AC17

Spray Canister Holders for 1477K and 1472K Storage HUB Tool Trolleys



**1477K-AC20**



125 x 105 x 307 mm

1 1477K-AC20

Laptop Boards for 1477K Storage HUB Tool Trolleys



**1477K-AC15**



80 x 298 x 424 mm

1 1477K-AC15

Roll Holders for 1477K and 1472K Storage HUB Tool Trolleys



**1477K-AC18**



33 x 265 x 313 mm

1 1477K-AC18

Power Tool Holders for 1477K and 1472K Storage HUB Tool Trolleys



**1477K-AC21**



115 x 175 x 302 mm

1 1477K-AC21

Windshield Supports for 1477K Storage HUB Tool Trolleys



**1477K-AC16**



106 x 115 x 208 mm

1 1477K-AC16

Document Holders for 1477K and 1472K Storage HUB Tool Trolleys



**1477K-AC19**



241 x 65 x 300 mm

1 1477K-AC19

Side Tool Panels for 1477K and 1472K Storage HUB Tool Trolleys



**1477K-AC22**



659 x 18 x 300 mm

1 1477K-AC22

Folding Tray for 1472K and 1477K Trolleys



**1477K-AC30**



22 x 430 x 460 mm

1 1477K-AC30

Pin Code Locking Systems for 1477K Storage HUB Tool Trolleys



**1477K-AC24**



135 x 36 x 62 mm

1 1477K-AC24

Wooden Top Middle Parts for 1477K & 1487K Storage HUB Tool Trolleys



**1477K-ACTW**



20 x 510 x 550 mm

1 1477K-ACTW

Removable Drawer Dividers for 1477K Storage HUB Tool Trolleys



**1477K-AC26**



48 x 2 x 147 mm 0.07 kg

1 1477K-AC26

Mifare Locking Systems for 1477K Storage HUB Tool Trolleys



**1477K-AC25**



135 x 36 x 62 mm

1 1477K-AC25

Composite Bench Tops for 1477K Storage HUB Tool Trolley



**1477K-ACTP**



20 x 510 x 550 mm

1 1477K-ACTP

Bottom Drawers for 1477K Storage HUB Tool Trolleys



**1477K-AC10**



110 x 390 x 495 mm

1 1477K-AC10

Stainless Steel Top Middle Parts for 1477K & 1487K Storage HUB Tool Trolleys



**1477K-ACTSS**



20 x 510 x 550 mm

1 1477K-ACTSS

MDF Top Middle Parts for 1477K Storage HUB Tool Trolleys



**1477K-ACTD**



20 x 510 x 550 mm

1 1477K-ACTD





Stainless Steel Tops for 1472K & 1482K Storage HUB Tool Trolley



**1472K-ACTSS**



30 x 501 x 682 mm

1 1472K-ACTSS

53" Tool Trolleys with 7 Drawers



**1476KXXL7BK**



986 x 501 x 1430 mm

1 1476KXXL7BK

40" Classic C75 Tool Trolleys with 12 Drawers



**1475KXXL12**



986 x 501 x 1100 mm  
986 x 501 x 1100 mm  
986 x 501 x 1100 mm

1 1475KXXL12  
1 1475KXXL12BLACK  
1 1475KXXL12RED

Chestnut Wood Tops for 1472K & 1482K Storage HUB Tool Trolley



**1472K-ACTW**



30 x 501 x 680 mm

1 1472K-ACTW

53" Double Bank Tool Trolleys with 12 Drawers



**1471KXXL12BKTSS**



1016 x 501 x 1440 mm

1 1471KXXL12BKTSS

40" Classic C75 Tool Trolleys with 8 Drawers



**1475KXXL8**



986 x 501 x 1100 mm  
986 x 501 x 1100 mm  
986 x 501 x 1100 mm  
986 x 501 x 1100 mm

1 1475KXXL8  
1 1475KXXL8BLACK  
1 1475KXXL8BLUE  
1 1475KXXL8RED

MDF Tops for 1472K & 1482K Storage HUB Tool Trolley



**1472K-ACTD**



30 x 501 x 682 mm

1 1472K-ACTD

53" Special Tool Trolley with 8 Drawers and Side Cabinet



**1475KXXL8CWTSS**



1218 x 500 x 1505 mm 1089 kg

1 1475KXXL8CWTSS

40" Classic C75 Tool Trolleys with 7 Drawers



**1475KXXL7**



986 x 501 x 1100 mm  
986 x 501 x 1100 mm  
986 x 501 x 1100 mm  
986 x 501 x 1100 mm

1 1475KXXL7  
1 1475KXXL7BLACK  
1 1475KXXL7BLUE  
1 1475KXXL7RED



40" Classic C75 Tool Trolleys with 6 Drawers



**1475KXL6**

|                     |   |               |
|---------------------|---|---------------|
|                     |   |               |
| 986 x 501 x 1100 mm | 1 | 1475KXL6      |
| 986 x 501 x 1100 mm | 1 | 1475KXL6BLACK |
| 986 x 501 x 1100 mm | 1 | 1475KXL6BLUE  |
| 986 x 501 x 1100 mm | 1 | 1475KXL6RED   |

26" Classic C75 Tool Trolleys with 8 Drawers



**1475K8**

|                    |   |             |
|--------------------|---|-------------|
|                    |   |             |
| 956 x 501 x 763 mm | 1 | 1475K8      |
| 956 x 501 x 763 mm | 1 | 1475K8BLACK |
| 956 x 501 x 763 mm | 1 | 1475K8BLUE  |
| 956 x 501 x 763 mm | 1 | 1475K8RED   |

26" Low Height Tool Trolleys with 7 Drawers



**1470K7LH**

|                    |   |              |
|--------------------|---|--------------|
|                    |   |              |
| 755 x 501 x 760 mm | 1 | 1470K7LH     |
| 755 x 501 x 760 mm | 1 | 1470K7LHBLUE |
| 755 x 501 x 760 mm | 1 | 1470K7LHGREY |
| 755 x 501 x 760 mm | 1 | 1470K7LHRED  |

40" Classic C75 Tool Trolleys with 6 Drawers and Side Cabinet



**1475KXL6C**

|                     |   |                |
|---------------------|---|----------------|
|                     |   |                |
| 986 x 501 x 1100 mm | 1 | 1475KXL6C      |
| 986 x 501 x 1100 mm | 1 | 1475KXL6CBLACK |

26" Classic C75 Tool Trolleys with 7 Drawers



**1475K7**

|                    |   |             |
|--------------------|---|-------------|
|                    |   |             |
| 956 x 501 x 763 mm | 1 | 1475K7      |
| 956 x 501 x 763 mm | 1 | 1475K7BLACK |
| 956 x 501 x 763 mm | 1 | 1475K7BLUE  |
| 956 x 501 x 763 mm | 1 | 1475K7RED   |

26" Classic C85 Top Chests with 4 Drawers



**1485K4**

|                    |   |             |
|--------------------|---|-------------|
|                    |   |             |
| 417 x 500 x 677 mm | 1 | 1485K4      |
| 417 x 500 x 677 mm | 1 | 1485K4BLACK |
| 417 x 500 x 677 mm | 1 | 1485K4BLUE  |
| 417 x 500 x 677 mm | 1 | 1485K4RED   |

40" Classic C85 Top Chests with 4 Drawers



**1485KXL4**

|                     |   |               |
|---------------------|---|---------------|
|                     |   |               |
| 417 x 500 x 1016 mm | 1 | 1485KXL4      |
| 417 x 500 x 1016 mm | 1 | 1485KXL4BLACK |
| 417 x 500 x 1016 mm | 1 | 1485KXL4BLUE  |
| 417 x 500 x 1016 mm | 1 | 1485KXL4RED   |

26" Classic C75 Tool Trolleys with 6 Drawers



**1475K6**

|                    |   |             |
|--------------------|---|-------------|
|                    |   |             |
| 956 x 501 x 763 mm | 1 | 1475K6      |
| 956 x 501 x 763 mm | 1 | 1475K6BLACK |
| 956 x 501 x 763 mm | 1 | 1475K6BLUE  |
| 956 x 501 x 763 mm | 1 | 1475K6RED   |

Stainless Steel Tops for 1475KXXL Tool Trolley



**1475KXXL-ACTSS**

|                    |   |                |
|--------------------|---|----------------|
|                    |   |                |
| 45 x 495 x 1347 mm | 1 | 1475KXXL-ACTSS |



Chestnut Wood Tops for 1475KXXL Tool Trolley



**1475KXXL-ACTW**



45 x 495 x 1347 mm

1 1475KXXL-ACTW

Stainless Steel Tops for Tool Trolleys 40 mm



**1470K-ACTSS**



40 x 495 x 1010 mm  
38 x 495 x 670 mm

1 1470KXL-ACTSS  
1 1470K-ACTSS

Chestnut Tops for Tool Trolleys 40 mm



**1470K-ACTW**



40 x 500 x 1012 mm  
40 x 497 x 674 mm

1 1470KXL-ACTW  
1 1470K-ACTW

MDF Top for Tool Trolleys 40 mm



**1470K-ACTD**



40 x 495 x 1012 mm  
40 x 497 x 674 mm

1 1470KXL-ACTD  
1 1470K-ACTD

Side Cabinet with Lock for 1475KXL Trolley



**1475KXL-AC20BK**



820 x 503 x 419 mm

1 1475KXL-AC20BK

Foldable Trays for 1470 and 1475 Drawers



**1470K-AC1**



9 x 455 x 395 mm

1 1470K-AC1

Tool Holders for 23 Pcs Screwdrivers/Pry Bars

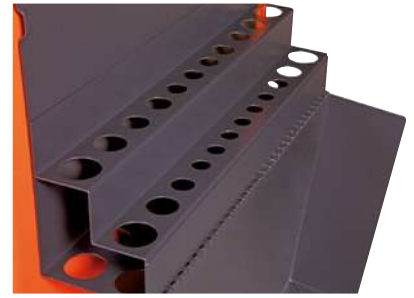

**1470K-AC2**



280 x 100 x 428 mm

1 1470K-AC2

Can Holders for 1470 and 1475 Drawers



**1470K-AC3**



140 x 90 x 457 mm

1 1470K-AC3

Document Holders for 1470 and 1475 Drawers



**1470K-AC4**



180 x 83 x 360 mm

1 1470K-AC4

Metallic Side Panels with Slots and Dots



**1470K-ACSIDE**



822 x 20 x 418 mm



1 1470K-ACSIDE

Tool Panels for 1475K 26" Trolleys



**1470K-AC8**



850 x 25 x 680 mm  
850 x 25 x 680 mm



1 1470K-AC8  
1 1470K-AC8GR

Three Tray Steel Roll Carts



**1470KC3A**



1051 x 435 x 764 mm



1 1470KC3A

26" ABS Tops for 26" Trolleys



**1470K-AC7**



45 x 497 x 674 mm



1 1470K-AC7

Metallic Adjustable Trays for Side Cabinet



**1470KXLC-TRAY**



470 x 10 x 310 mm



1 1470KXLC-TRAY

Two Tray Steel Roll Carts



**1470KC2**



1051 x 435 x 764 mm



1 1470KC2

Metallic Side Panels for 1495TP Hook System



**1475K-ACSIDE**



822 x 20 x 418 mm



1 1475K-ACSIDE

Multifunctional Two Tray Aluminium Roll Carts



**1470KC5**



1051 x 435 x 1381 mm  
1051 x 435 x 1381 mm



1 1470KC5  
1 1470KC5PC

Middle Trays for 1470KC2 Roll Cart



**1470KCTRAY**



750 mm 420 mm



1 1470KCTRAY



Folding Transport Trolleys with Aluminium Tray



**1430FT120**

|                     |        |   |           |
|---------------------|--------|---|-----------|
|                     |        |   |           |
| 1077 x 520 x 487 mm | 6.4 kg | 1 | 1430FT120 |

General Purpose 11 Foam Tool Kit - 758 pcs



**FF1BSET-MONSTER**

|                   |   |                 |
|-------------------|---|-----------------|
|                   |   |                 |
| 40 x 445 x 880 mm | 1 | FF1BSET-MONSTER |

|          |  |
|----------|--|
| FF1B01LM |  |
| FF1B02LM |  |
| FF1B03LM |  |
| FF1B04LM |  |
| FF1B05LM |  |
| FF1B10LM |  |
| FF1B11LM |  |
| FF1B08LM |  |
| FF1B09LM |  |
| FF1B06LM |  |
| FF1B07LM |  |

Foam Inlay for 40" Trolley 1/4" Metric & Imperial Socket Sets - 141 pcs



**FF1B01LM**

|                   |   |          |
|-------------------|---|----------|
|                   |   |          |
| 35 x 445 x 880 mm | 1 | FF1B01LM |

|   |  |  |
|---|--|--|
| 6700SM-10, 6700SM-11, 6700SM-12, 6700SM-13, 6700SM-14, 6700SM-4, 6700SM-4.5, 6700SM-5, 6700SM-5.5, 6700SM-6, 6700SM-7, 6700SM-8, 6700SM-9   |  |  |
| 6700SZ-1/2, 6700SZ-1/8, 6700SZ-9/16, 6700SZ-1/4, 6700SZ-11/32, 6700SZ-3/16, 6700SZ-3/8, 6700SZ-5/16, 6700SZ-7/16, 6700SZ-7/32, 6700SZ-9/32, 6700SZ-5/32                               |  |  |
| 6700TORX-E4, 6700TORX-E5, 6700TORX-E6, 6700TORX-E7, 6700TORX-E8, 6700TORX-E10   |  |  |
| 6950SL  |  |  |
| 6962L, 6960, 6961   |  |  |
| 6972H   |  |  |
| 7400SM-10, 7400SM-11, 7400SM-12, 7400SM-13, 7400SM-14, 7400SM-15, 7400SM-16, 7400SM-17, 7400SM-18, 7400SM-19, 7400SM-20, 7400SM-21, 7400SM-22, 7400SM-6, 7400SM-7, 7400SM-8, 7400SM-9 |  |  |
| 7400TORX-E10, 7400TORX-E11, 7400TORX-E12, 7400TORX-E14, 7400TORX-E16, 7400TORX-E18  |  |  |
| 7406ZZ-16, 7406ZZ-21  |  |  |
| 7409TORX-R-T27, 7409TORX-R-T30, 7409TORX-R-T40, 7409TORX-R-T45, 7409TORX-R-T50  |  |  |
| 7409TORX-T25, 7409TORX-T27, 7409TORX-T30, 7409TORX-T40, 7409TORX-T45, 7409TORX-T50  |  |  |
| 7750SL  |  |  |
| 2058-BR   |  |  |
| 8164-1/2  |  |  |
| A6800DM-10, A6800DM-12, A6800DM-13, A6800DM-4, A6800DM-5, A6800DM-5.5, A6800DM-6, A6800DM-7, A6800DM-8, A6800DM-9, A6800DM-11, A6800DM-14   |  |  |
| A6800DZ-9/16, A6800DZ-1/2, A6800DZ-1/4, A6800DZ-11/32, A6800DZ-3/16, A6800DZ-3/8, A6800DZ-5/16, A6800DZ-7/16, A6800DZ-7/32, A6800DZ-9/32  |  |  |
| A7400DZ-1/2, A7400DZ-11/16, A7400DZ-3/4, A7400DZ-3/8, A7400DZ-5/8, A7400DZ-7/16, A7400DZ-17/32, A7400DZ-9/16, A7400DZ-19/32, A7400DZ-13/16, A7400DZ-7/8, A7400DZ-1/4, A7400DZ-5/16    |  |  |
| K6650-1/4-1P  |  |  |
| K6625-1/4-1P  |  |  |
| 6954  |  |  |

|  |  |
|--|--|
| 6956   |  |
| 6963   |  |
| 6966   |  |
| 7760, 7761, 7762   |  |
| 7764   |  |
| 7765   |  |
| 7766   |  |
| 7409BH-4, 7409BH-5, 7409BH-6, 7409BH-8, 7409BH-10  |  |
| A7402DM-10, A7402DM-11, A7402DM-12, A7402DM-13, A7402DM-14, A7402DM-15, A7402DM-16, A7402DM-17, A7402DM-18, A7402DM-19, A7402DM-8, A7402DM-9 |  |
| K6650-3/8-1P   |  |
| 7756   |  |

Foam Inlay for 40" Trolley 1/2" Metric & Imperial Socket Sets - 76 pcs



**FF1B02LM**

|                   |   |          |
|-------------------|---|----------|
|                   |   |          |
| 40 x 445 x 880 mm | 1 | FF1B02LM |

|  |  |  |
|--|--|--|
| 7800DM-10, 7800DM-11, 7800DM-12, 7800DM-13, 7800DM-14, 7800DM-15, 7800DM-16, 7800DM-17, 7800DM-18, 7800DM-19, 7800DM-20, 7800DM-21, 7800DM-22, 7800DM-24, 7800DM-27, 7800DM-30, 7800DM-32, 7800DM-34, 7800DM-36                |  |  |
| 7800DZ-1, 7800DZ-1.1/16, 7800DZ-1.1/4, 7800DZ-1.1/8, 7800DZ-1.3/16, 7800DZ-1/2, 7800DZ-11/16, 7800DZ-13/16, 7800DZ-15/16, 7800DZ-25/32, 7800DZ-3/4, 7800DZ-3/8, 7800DZ-5/8, 7800DZ-7/16, 7800DZ-7/8, 7800DZ-9/16, 7800DZ-19/32 |  |  |
| 7809M-10, 7809M-12, 7809M-14, 7809M-4, 7809M-5, 7809M-6, 7809M-7, 7809M-8  |  |  |
| 8150SL   |  |  |
| SBS87  |  |  |
| K7801M-13, K7801M-15, K7801M-16, K7801M-17, K7801M-18, K7801M-19, K7801M-21, K7801M-22, K7801M-24  |  |  |
| K8160D-2   |  |  |
| K7806M-13, K7806M-14, K7806M-16, K7806M-17, K7806M-18, K7806M-19, K7806M-21, K7806M-22, K7806M-24  |  |  |
| 7809M-5-100, 7809M-6-100, 7809M-7-100, 7809M-8-120, 7809M-10-140   |  |  |
| K6650-1/2-1P   |  |  |
| 8160-3, 8160-5, 8160-10  |  |  |
| 8171   |  |  |
| 8166   |  |  |



Foam Inlay for 40" Trolley Combination Spanner & Ratcheting Spanner Sets - 36 pcs



**FF1B03LM**



35 x 445 x 880 mm

1 FF1B03LM

111M-10, 111M-11, 111M-12, 111M-13, 111M-14, 111M-15, 111M-16, 111M-17, 111M-18, 111M-19, 111M-20, 111M-21, 111M-22, 111M-24, 111M-27, 111M-30, 111M-32, 111M-34, 111M-8, 111M-9



1RM-10, 1RM-11, 1RM-12, 1RM-13, 1RM-14, 1RM-15, 1RM-16, 1RM-17, 1RM-18, 1RM-19, 1RM-21, 1RM-22, 1RM-24, 1RM-27, 1RM-8, 1RM-9



Foam Inlay for 40" Trolley Combination Spanner, Flex-Head Spanners & Telescopic Mirror - 26 pcs



**FF1B04LM**



35 x 445 x 880 mm

1 FF1B04LM

1RM-30, 1RM-32



111Z-1, 111Z-1.1/16, 111Z-1.1/4, 111Z-1.1/8, 111Z-1/2, 111Z-11/16, 111Z-13/16, 111Z-15/16, 111Z-3/4, 111Z-3/8, 111Z-5/16, 111Z-5/8, 111Z-7/16, 111Z-7/8, 111Z-9/16



4040M-10-11, 4040M-12-13, 4040M-14-15, 4040M-16-17, 4040M-18-19, 4040M-8-9



5515T



BLTS7P



2535L



Foam Inlay for 40" Trolley Pliers, Compact Pliers, Spanners & Calipers - 32 pcs



**FF1B05LM**



35 x 445 x 880 mm

1 FF1B05LM

1150-1/2H/P



1520 G



1620



2101S-160



21HDG-160



2223 S-150



2430 G-160



2430 S-200



2628 G-180

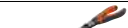

2628 S-180



2744



426TOR9



KBGU-10P-DISPEN

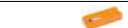

KERU-01



MTC-5-16-C1



8224



9029, 9031



806-1-3



C3330R



C3530



C3230

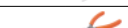

C3640

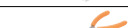

Foam Inlay for 40" Trolley ERGO™ Insulated and Precision Screwdriver Sets - 88 pcs



**FF1B06LM**



40 x 445 x 880 mm

1 FF1B06LM

|  |  |
|--|--|
| 700-2.5-50, 700-2-50, 700-3-50                               |  |
| 701-00-50, 701-0-50, 701-1-75                                |  |
| 703-10-50, 703-15-75, 703-6-50, 703-7-50, 703-8-50, 703-9-50 |  |
| 808050L  |  |
| BE-8010S   |  |
| BE-8020, BE-8040   |  |
| BE-8040SL, BE-8050SL   |  |
| BE-8150, BE-8155, BE-8256                                    |  |
| BE-8355  |  |
| BE-8600, BE-8611, BE-8621, BE-8623                           |  |
| BE-8600S   |  |
| BE-8602  |  |
| BE-8610SL, BE-8620SL   |  |
| BE-8702, BE-8725   |  |
| BE-8820SL  |  |
| BE-8870  |  |
| BE-8975B   |  |
| BE-9777B   |  |
| BE-9787  |  |
| BE-9770  |  |
| BE-9785  |  |

Foam Inlay for 40" Trolley ERGO™ Screwdrivers & Bit Sets - 169 pcs



**FF1B07LM**



40 x 445 x 880 mm

1 FF1B07LM

BE-8256TB, BE-8258TB



BE-8620TB, BE-8623TB



59/S100BC



7455-200



BE-8907, BE-8908, BE-8909, BE-8910, BE-8915, BE-8920, BE-8925, BE-8927, BE-8930, BE-8940



BE-8811, BE-8821



BE-8830



BE-8802

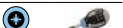

BE5049T



BE-7607





Foam Inlay for 40" Trolley Striking, Filing & Extracting Sets - 45 pcs



**FF1B08LM**

40 x 445 x 880 mm 1 FF1B08LM

|  |  |
|--|--|
| 1-100-08-2-2                                   |  |
| 1-170-08-2-2                                   |  |
| 1-210-08-2-2                                   |  |
| 1-230-08-2-2                                   |  |
| 1435/5   |  |
| 2484-30, 2484-45, 2484-60                      |  |
| 3734-2, 3734-3, 3734-4, 3734-5, 3734-6, 3734-8 |  |
| 3735-4-120, 3735-5-120                         |  |
| 3740-150, 3740-250                             |  |
| 4543-3   |  |
| 4611-3   |  |
| 481-400  |  |
| 7865   |  |
| 3625N-32                                       |  |
| 1418-4, 1418-5, 1418-6, 1418-7.5               |  |

Foam Inlay for 40" Trolley Hexagonal T-Handle, Multi-Position Pry Bars & Feeler Gauges Sets - 21 pcs



**FF1B09LM**

35 x 445 x 880 mm 1 FF1B09LM

|  |  |
|--|--|
| 900T-025-100, 900T-030-100, 900T-040-150, 900T-050-150, 900T-060-200, 900T-080-200               |  |
| 901T-010-100, 901T-015-150, 901T-020-150, 901T-025-150, 901T-027-150, 901T-030-200, 901T-040-200 |  |
| BE256-155, BE256-178, BE256-250  |  |
| BE66152  |  |
| BT10P325, BT10P330, BT10P338   |  |
| 1544   |  |

Foam Inlay for 40" Trolley Hand Hacksaw, Circip Pliers & Grips - 20 pcs



**FF1B10LM**

45 x 445 x 880 mm 1 FF1B10LM

|                    |  |
|--------------------|--|
| 2633/S4            |  |
| 2800-140, 2800-180 |  |
| 2890-125, 2890-180 |  |
| 2900-140, 2900-180 |  |
| 2951-180           |  |
| 2952-165           |  |
| 2963-280           |  |
| 2965-200           |  |
| 2990-125, 2990-180 |  |
| BE-8986            |  |
| 325                |  |
| 2681               |  |
| CR B 02            |  |

Foam Inlay for 40" Trolley Metal Clips for 1/4", 3/8", 1/2" Sockets & 3/4" Sockets Set - 104 pcs



**FF1B11LM**

50 x 445 x 880 mm 1 FF1B11LM

|           |  |
|-----------|--|
| RAIL-264  |  |
| CLIPS-1/4 |  |
| CLIPS-3/8 |  |
| CLIPS-1/2 |  |
| SLX 17    |  |

General Purpose 12 Foam Tool Kit - 560 pcs



**FF1ASET-XLARGE**

40 x 543 x 445 mm 1 FF1ASET-XLARGE

|           |  |
|-----------|--|
| FF1A195LM |  |
| FF1A196LM |  |
| FF1A197LM |  |
| FF1A198LM |  |
| FF1A199LM |  |
| FF1A200LM |  |
| FF1A201LM |  |
| FF1A202LM |  |
| FF1A203LM |  |
| FF1A204LM |  |
| FF1A205LM |  |
| FF1A206LM |  |

General Purpose 6 Foam Tool Kit - 346 pcs



**FF1ASET-LARGE**

40 x 543 x 445 mm 1 FF1ASET-LARGE

|           |  |
|-----------|--|
| FF1A207LM |  |
| FF1A208LM |  |
| FF1A209LM |  |
| FF1A210LM |  |
| FF1A211LM |  |
| FF1A212LM |  |

General Purpose 3 Foam Tool Kit - 158 pcs



**FF1ASET-BASIC**



40 x 543 x 445 mm

1 FF1ASET-BASIC

FF1A214LM

FF1A215LM

FF1A216LM

MRO 7 Foam Toolkit - 256 Pcs



**FF1ASET-MRO2**



530 x 600 x 800 mm

1 FF1ASET-MRO2

FF1A130

FF1A131

FF1A132

FF1A133

FF1A134

FF1A135

FF1A136

MRO 5 Foam Toolkit - 188 Pcs



**FF1ASET-MRO3**



530 x 600 x 800 mm

1 FF1ASET-MRO3

FF1A138

FF1A134

FF1A139

FF1A141

FF1A137

MRO 4 Foam Toolkit - 147 Pcs



**FF1ASET-MRO4**



530 x 600 x 800 mm

1 FF1ASET-MRO4

FF1A143

FF1A145

FF1A134

FF1A142

MRO 3 Foam Toolkit - 84 Pcs



**FF1ASET-MRO5**



530 x 600 x 800 mm

1 FF1ASET-MRO5

FF1A147

FF1A146

FF1A134

Auto Repair 8 Foam Tool Kit - 357 pcs



**FF1ASET-AUTO**



40 x 543 x 445 mm

1 FF1ASET-AUTO

FF1A218LM

FF1A219LM

FF1A220LM

FF1A221LM

FF1A222LM

FF1A223LM

FF1A224LM

FF1A225LM

Auto Repair 5 Foam Toolkit - 196 Pcs



**FF1ASET-AUTO1**



50 x 543 x 445 mm

1 FF1ASET-AUTO1

FF1A19

FF1A20

FF1A21

FF1A23

FF1A22



Auto Repair 4 Foam Toolkit - 168 Pcs



**FF1ASET-AUTO2**



50 x 543 x 445 mm

1 FF1ASET-AUTO2

|        |  |
|--------|--|
| FF1A19 |  |
| FF1A24 |  |
| FF1A21 |  |
| FF1A25 |  |

Auto Repair 3 Foam Toolkit - 140 Pcs



**FF1ASET-AUTO3**



50 x 543 x 445 mm

1 FF1ASET-AUTO3

|        |  |
|--------|--|
| FF1A28 |  |
| FF1A26 |  |
| FF1A27 |  |

Auto Repair 4 Foam Toolkit - 177 Pcs



**FF1ASET-AUTO6**



50 x 543 x 445 mm

1 FF1ASET-AUTO6

|        |  |
|--------|--|
| FF1A19 |  |
| FF1A72 |  |
| FF1A70 |  |
| FF1A71 |  |

Auto Repair 2 Foam Tool Kit - 62 pcs



**FF1ASET-AUTO-M1**



50 x 543 x 445 mm

1 FF1ASET-AUTO-M1

|  |  |
|--|--|
| BP910  |  |
| BP909TH  |  |
| BE-9678  |  |
| BE-9675  |  |
| 29M-30   |  |
| 2997-250   |  |
| 1995LM-9, 1995LM-8, 1995LM-6   |  |
| 3750   |  |
| 1177-SCRIBE  |  |
| K7801M-9, K7801M-10, K7801M-11, K7801M-12, K7801M-13, K7801M-14, K7801M-15, K7801M-16, K7801M-17, K7801M-18, K7801M-19, K7801M-21, K7801M-22, K7801M-23, K7801M-24, K7801M-30, K7801M-32 |  |
| K7806M-15, K7806M-21, K7806M-24, K7806M-27   |  |
| K8901M-32, K8901M-34, K8901M-36  |  |
| K8964D   |  |
| K8167S   |  |

K8160D-3

2800-150

2900-150

3734S/6

BE-8258TB



Auto Repair 2 Foam & SAC Alignment Tool Kit - 54 pcs



**FF1ASET-AUTO-M2**

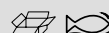

60 x 543 x 445 mm

1 FF1ASET-AUTO-M2

|  |  |
|--|--|
| BE301  |  |
| K7801TORX-E10, K7801TORX-E12, K7801TORX-E14, K7801TORX-E16, K7801TORX-E18, K7801TORX-E20 |  |
| K8160D-2   |  |
| BE301CM  |  |
| BWHEPSSH8  |  |
| BE51038, BE510310, BE510312  |  |
| BP822  |  |
| BP825  |  |

Auto Repair 2 Foam Tool Kit - 34 pcs



**FF1ASET-AUTO-M3**



40 x 543 x 445 mm

1 FF1ASET-AUTO-M3

|            |  |
|------------|--|
| BE1GP5T    |  |
| 6968       |  |
| BE1SP1F    |  |
| BE6OF108   |  |
| BE6307414F |  |
| BE6OFW     |  |



|                           |  |
|---------------------------|--|
| BE1FFWF                   |  |
| BE63064514F1              |  |
| BE6810Z, BE6810           |  |
| BE6FCP                    |  |
| 52                        |  |
| 1546                      |  |
| 5515M                     |  |
| BE1P                      |  |
| 7455-60                   |  |
| BE1FLD2, BE1FLD1, BE1FLD3 |  |
| BE65F65120                |  |
| 7764                      |  |
| 8164-1/2                  |  |
| BE6302712F                |  |
| 6962-W                    |  |
| 6954                      |  |
| BE6701VAG                 |  |
| BE62110                   |  |
| BE1310P427                |  |
| 7406ZZ-21, 7406ZZ-16      |  |
| BE1SP14L                  |  |
| BE1GP5                    |  |
| 2421GC-160IP              |  |
| 8166                      |  |

Auto Repair 2 Foam Tool Kit - 32 pcs



**FF1ASET-AUTO-M5**

45 x 543 x 445 mm 1 FF1ASET-AUTO-M5

|   |  |
|---|--|
| 319   |  |
| 484-1000  |  |
| SB3654BM-20   |  |
| 3625S-44  |  |
| B192.004.200  |  |
| BE-8258TB   |  |
| 2484/S4   |  |
| 6225D   |  |
| B194.030.150, B194.025.125, B194.020.100, B194.010.075  |  |
| 600.005.012   |  |
| BBS165  |  |
| K7801TORX-E10, K7801TORX-E12, K7801TORX-E14, K7801TORX-E16, K7801TORX-E18, K7801TORX-E20, K7801TORX-E24 |  |
| BBR203P920, BBR203P925, BBR203P930, BBR203P940, BBR203P945, BBR203P950, BBR203P955, BBR203P960          |  |

Auto Repair 2 Foam Tool Kit - 23 pcs



**FF1ASET-AUTO-M4**

60 x 543 x 445 mm 1 FF1ASET-AUTO-M4

|  |  |
|--|--|
| BS618  |  |
| 4545-N1, 4545-N11  |  |
| 4545-1, 4545-2   |  |
| MTB-3-16   |  |
| 361-14   |  |
| 8900SM-41  |  |
| BS52   |  |
| 747-22, 747-21, 747-19, 747-17, 747-15, 747-14, 747-13, 747-12 |  |
| BS40VAG  |  |
| BS56   |  |
| BS100PSA1  |  |
| BS45BMW  |  |
| 8157-24  |  |
| 8171   |  |

Auto Repair 2 Foam Tool Kit - 42 pcs



**FF1ASET-AUTO-M6**

40 x 543 x 445 mm 1 FF1ASET-AUTO-M6

|       |  |
|-------|--|
| FM10  |  |
| 782-U |  |

|  |  |
|--|--|
| BBR405   |  |
| BBR400   |  |
| BBR210P3   |  |
| BBR6131  |  |
| BBR204   |  |
| BBR1501  |  |
| BBR501011, BBR50121314                           |  |
| 2900-215   |  |
| 7823   |  |
| BBR100   |  |
| 1154   |  |
| 6M-16-17, 6M-14-15                               |  |
| 1949M-17-19, 1949M-12-13, 1949M-10-11, 1949M-8-9 |  |

Fit&Go 3/3 Foam Laser Marked Inlay 1/2" & 1/4" Socket Set & Bit Set - 139 pcs



**FF1A195LM**

40 x 445 x 543 mm 1 FF1A195LM

|  |  |
|--|--|
| A6800DZ-9/16, A6800DZ-1/2, A6800DZ-1/4, A6800DZ-11/32, A6800DZ-3/16, A6800DZ-3/8, A6800DZ-5/16, A6800DZ-7/16, A6800DZ-7/32, A6800DZ-9/32 |  |
| K6625-1/4-1P   |  |
| K6650-1/4-1P   |  |
| 6954   |  |
| 6963   |  |
| K6650-3/8-1P   |  |
| 7767   |  |
| 8167   |  |
| 2058-BR  |  |
| 59/S31B  |  |
| SL25L  |  |
| S330L  |  |



Fit&Go 3/3 Foam Laser Marked Inlay 1/2" Socket Set & 1/2" Deep Socket Set - 67 pcs



**FF1A196LM**

40 x 445 x 543 mm 1 FF1A196LM

- 7800DZ-1.1/16, 7800DZ-1.1/4, 7800DZ-1.1/8, 7800DZ-1.3/16, 7800DZ-1/2, 7800DZ-11/16, 7800DZ-13/16, 7800DZ-15/16, 7800DZ-25/32, 7800DZ-3/4, 7800DZ-3/8, 7800DZ-5/8, 7800DZ-7/16, 7800DZ-7/8, 7800DZ-9/16, 7800DZ-19/32
- 7809M-10, 7809M-12, 7809M-14, 7809M-4, 7809M-5, 7809M-6, 7809M-7, 7809M-8
- 7809M-5-100, 7809M-6-100, 7809M-7-100, 7809M-8-120, 7809M-10-140
- K6650-1/2-1P
- S1612L
- 8967
- S240

Fit&Go 3/3 Foam Laser Marked Inlay 1/2" Impact Socket Set, Cutting & Measuring - 36 pcs



**FF1A197LM**

40 x 445 x 543 mm 1 FF1A197LM

- 1150-1/2H/P
- 2744
- 426TOR9
- K7801M-13, K7801M-15, K7801M-16, K7801M-17, K7801M-18, K7801M-19, K7801M-21, K7801M-22, K7801M-24
- K8160D-2
- K7806M-13, K7806M-14, K7806M-16, K7806M-17, K7806M-18, K7806M-19, K7806M-21, K7806M-22, K7806M-24
- KBGU-10P-DISPEN

- KERU-01
- MTC-5-16-C1
- 325
- 1544

Fit&Go 3/3 Foam Laser Marked Inlay Combination Spanners Set - 20 pcs



**FF1A198LM**

35 x 445 x 543 mm 1 FF1A198LM

- 111M-10, 111M-11, 111M-12, 111M-13, 111M-14, 111M-15, 111M-16, 111M-17, 111M-18, 111M-19, 111M-20, 111M-21, 111M-22, 111M-24, 111M-27, 111M-30, 111M-32, 111M-34, 111M-8, 111M-9

Fit&Go 3/3 Foam Laser Marked Inlay Adjustable, Ratcheting & Swivel Head Spanners Set - 23 pcs



**FF1A199LM**

35 x 445 x 543 mm 1 FF1A199LM

- 1RM-10, 1RM-11, 1RM-12, 1RM-13, 1RM-14, 1RM-15, 1RM-16, 1RM-17, 1RM-18, 1RM-19, 1RM-21, 1RM-22, 1RM-24, 1RM-8, 1RM-9
- 4040M-10-11, 4040M-12-13, 4040M-14-15, 4040M-16-17, 4040M-18-19, 4040M-8-9
- 9029, 9031

Fit&Go 3/3 Foam Laser Marked Inlay Pipe Wrench, Holding, Cutting & Circlip Pliers - 14 pcs



**FF1A200LM**

35 x 445 x 543 mm 1 FF1A200LM

- 1520 G
- 1620
- 2101G-160
- 2223 S-150
- 2233 D-160
- 2430 G-190HD
- 2628 G-180
- 2890-180
- 2990-180
- C3330R
- C3530
- C3230
- C3640
- 8224

Fit&Go 3/3 Foam Laser Marked Inlay ERGO™ Screwdrivers, Precision Screwdrivers & L-Keys - 37 pcs



**FF1A201LM**

40 x 445 x 543 mm 1 FF1A201LM

- BE-8256TB
- BE-8620TB, BE-8623TB
- 700-2-50
- 701-00-50, 701-0-50, 701-1-75
- 703-10-50, 703-15-75, 703-6-50, 703-7-50, 703-8-50, 703-9-50
- BE-8040SL
- BE-8040



|                                    |  |  |
|------------------------------------|--|--|
| BE-8150, BE-8155, BE-8256          |  |  |
| BE-8355                            |  |  |
| BE-8600, BE-8611, BE-8621, BE-8623 |  |  |
| BE-8602                            |  |  |
| BE-8811, BE-8821                   |  |  |
| BE-8802                            |  |  |
| BE-8870                            |  |  |
| BE-9787                            |  |  |

Fit&Go 3/3 Foam Laser Marked Inlay ERGO™ Screwdrivers, T-Handle Screwdrivers & L-Keys - 39 pcs



**FF1A202LM**

40 x 445 x 543 mm 1 FF1A202LM

|  |  |  |
|--|--|--|
| 900T-025-100, 900T-030-100, 900T-040-150, 900T-050-150, 900T-060-200, 900T-080-200 |  |  |
| BE-8907, BE-8908, BE-8909, BE-8910, BE-8915, BE-8920, BE-8925, BE-8927, BE-8930    |  |  |
| BE-8702, BE-8725   |  |  |
| BE-9770  |  |  |
| BE-9785  |  |  |

Fit&Go 3/3 Foam Laser Marked Inlay Ratcheting Screwdrivers, T-Handle Screwdrivers & Bit Set - 114 pcs



**FF1A203LM**

40 x 445 x 543 mm 1 FF1A203LM

|  |  |  |
|--|--|--|
| 59/S100BC  |  |  |
| 808050L  |  |  |
| 2058-BR  |  |  |
| 901T-010-100, 901T-015-150, 901T-020-150, 901T-025-150, 901T-027-150, 901T-030-200, 901T-040-200 |  |  |

Fit&Go 3/3 Foam Laser Marked Inlay Striking & Files - 40 pcs



**FF1A204LM**

40 x 445 x 543 mm 1 FF1A204LM

|  |  |
|--|--|
| 1-100-08-2-2                                   |  |
| 1-170-08-2-2                                   |  |
| 1-210-08-2-2                                   |  |
| 1-230-08-2-2                                   |  |
| 1435/5   |  |
| 3734-2, 3734-3, 3734-4, 3734-5, 3734-6, 3734-8 |  |
| 3735-4-120, 3735-5-120                         |  |
| 3740-150, 3740-250                             |  |
| 481-400  |  |
| 7865   |  |
| 3625N-32                                       |  |
| 1418-4, 1418-5, 1418-6, 1418-7.5               |  |

Fit&Go 3/3 Foam Laser Marked Inlay Awls, Hooks, Inspection Mirrors & Rivet Gun - 14 pcs



**FF1A205LM**

35 x 445 x 543 mm 1 FF1A205LM

|           |  |
|-----------|--|
| 2484-45   |  |
| 2633/S4   |  |
| 2951-180  |  |
| 5515T     |  |
| BE66152   |  |
| BE-8986   |  |
| BT10P330  |  |
| 2681      |  |
| 1450D-ISO |  |
| 806-1-3   |  |
| 5515FL    |  |

Fit&Go 3/3 Foam Laser Marked Inlay 3/4" Socket Set - 17 pcs



**FF1A206LM**

50 x 445 x 543 mm 1 FF1A206LM

SLX 17

Fit&Go 3/3 Foam Laser Marked Inlay 1/4" & 3/8" Socket Set, T-Handle Screwdrivers, Caliper & Bit Set - 192 pcs



**FF1A207LM**

40 x 445 x 543 mm 1 FF1A207LM

|              |  |
|--------------|--|
| 1150-1/2H/P  |  |
| 59/S100BC    |  |
| 808050L      |  |
| 2058-BR      |  |
| K6650-1/4-1P |  |
| 6956         |  |
| 6963         |  |
| K6650-3/8-1P |  |
| 8967/S3      |  |
| 6966         |  |
| 6954         |  |
| 696EX-08     |  |
| 904T-060-150 |  |
| 905T-060-100 |  |
| 6973A        |  |
| SL25L        |  |
| S330         |  |



Fit&Go 3/3 Foam Laser Marked Inlay  
Socket Set, 1/2" Impact Socket Set &  
Cutting - 56 pcs



### FF1A208LM



45 x 445 x 543 mm



1 FF1A208LM

2744

7809M-10, 7809M-12, 7809M-14,  
7809M-4, 7809M-5, 7809M-6, 7809M-7,  
7809M-8

K7801M-13, K7801M-15, K7801M-16,  
K7801M-17, K7801M-18, K7801M-19,  
K7801M-21, K7801M-22, K7801M-24

K8160D-2

KBGU-10P-DISPEN

KERU-01

319

K6650-1/2-1P

S240

Fit&Go 3/3 Foam Laser Marked Inlay  
Combination Spanners & Magnetic Pick-  
Up with LED Light - 56 pcs



### FF1A209LM



35 x 445 x 543 mm



1 FF1A209LM

111M-10, 111M-11, 111M-12, 111M-13,  
111M-14, 111M-15, 111M-16, 111M-17,  
111M-18, 111M-19, 111M-20, 111M-21,  
111M-22, 111M-24, 111M-27, 111M-30,  
111M-32, 111M-34, 111M-8, 111M-9

2535L

Fit&Go 3/3 Foam Laser Marked Inlay  
ERGO™ Screwdrivers, Spanners & Pliers - 24 pcs



ergo



### FF1A210LM



40 x 445 x 543 mm



1 FF1A210LM

1RM-10, 1RM-11, 1RM-12, 1RM-13,  
1RM-14, 1RM-15, 1RM-16, 1RM-17,  
1RM-18, 1RM-19, 1RM-8, 1RM-9

1520 G

2101G-160

2430 G-190HD

2628 G-180

BE-8602

BE-8611, BE-8621

BE-8811, BE-8821

BE-8802

8224

9031

Fit&Go 3/3 Foam Laser Marked Inlay  
ERGO™ Screwdrivers, T-Handle  
Screwdrivers & L-Keys - 35 pcs



ergo



### FF1A211LM



40 x 445 x 543 mm



1 FF1A211LM

900T-025-100, 900T-030-100, 900T-  
040-150, 900T-050-150, 900T-060-200,  
900T-080-200

BE-8910, BE-8915, BE-8920, BE-8925,  
BE-8930

BE-8020, BE-8040

BE-8050SL

BE-8150, BE-8155

BE-8355

BE-9787

BE-9770

Fit&Go 3/3 Foam Laser Marked Inlay  
ERGO™ Screwdrivers, T-Handle  
Screwdrivers & L-Keys - 18 pcs



ergo



### FF1A212LM



35 x 445 x 543 mm



1 FF1A212LM

1-100-08-2-2

1-210-08-2-2

1-230-08-2-2

3734-2, 3734-3, 3734-4, 3734-5, 3734-  
6, 3734-8

3735-4-120

3740-150, 3740-250

426TOR9

481-400

BE-8986

MTC-5-16-C1

2446

3625N-32

Fit&Go 3/3 Foam Inlay 1/4" & 3/8" Socket  
Set & Torque Wrench - 85 pcs



### FF1A213



52 x 445 x 543 mm



1 FF1A213

8150SL

7800SM-8, 7800SM-9, 7800SM-12,  
7800SM-13, 7800SM-10, 7800SM-11,  
7800SM-30, 7800SM-32, 7800SM-24,  
7800SM-22, 7800SM-23, 7800SM-27,  
7800SM-16, 7800SM-17, 7800SM-14,  
7800SM-15, 7800SM-21, 7800SM-18,  
7800SM-19

7455-200

|  |  |  |
|--|--|--|
| 7809TORX-T45, 7809TORX-T40,<br>7809TORX-T30, 7809TORX-T20,<br>7809TORX-T25   |  |  |
| 7809M-6, 7809M-5, 7809M-7,<br>7809M-10, 7809M-14, 7809M-12   |  |  |
| 7809M-6-140, 7809M-5-180, 7809M-10-<br>140, 7809M-8-120  |  |  |
| 6950SL   |  |  |
| 6962-W, K6650-1/4-1P   |  |  |
| 6960-W   |  |  |
| 6968   |  |  |
| 6700SM-9, 6700SM-10, 6700SM-7,<br>6700SM-8, 6700SM-13, 6700SM-14,<br>6700SM-11, 6700SM-12, 6700SM-4,<br>6700SM-6, 6700SM-5                                       |  |  |
| 6709M-6, 6709M-8, 6709M-4, 6709M-5,<br>6709M-3   |  |  |
| A6709M-2.5, A6709M-5, A6709M-6,<br>A6709M-3, A6709M-4  |  |  |
| 6962L  |  |  |
| 7400SM-17, 7400SM-18, 7400SM-15,<br>7400SM-16, 7400SM-19, 7400SM-9,<br>7400SM-10, 7400SM-7, 7400SM-8,<br>7400SM-13, 7400SM-14, 7400SM-11,<br>7400SM-12, 7400SM-6 |  |  |
| 7760-W, 7761-W   |  |  |
| 7750SL   |  |  |
| 7768   |  |  |
| 8160-5, 8160-10  |  |  |
| 8166   |  |  |

Fit&Go 3/3 Foam Laser Marked Inlay 1/4" & 1/2" Socket Set, Pliers & Bit Set - 91 pcs



### FF1A214LM

40 x 445 x 543 mm 1 FF1A214LM

|              |  |  |
|--------------|--|--|
| 2058-BR      |  |  |
| K6650-1/4-1P |  |  |
| 6956         |  |  |
| 6963         |  |  |
| K6650-1/2-1P |  |  |
| SL25         |  |  |
| 8072         |  |  |
| 2971G-250    |  |  |
| 806-1-3      |  |  |
| 2171G-160    |  |  |
| 59/S31B      |  |  |
| S240         |  |  |

Fit&Go 3/3 Foam Laser Marked Inlay ERGO™ Screwdrivers & Combination Spanners - 31 pcs



### FF1A215LM

40 x 445 x 543 mm 1 FF1A215LM

|   |  |  |
|---|--|--|
| 111M-10, 111M-11, 111M-12, 111M-13,<br>111M-14, 111M-15, 111M-16, 111M-17,<br>111M-18, 111M-19, 111M-20, 111M-21,<br>111M-22, 111M-24, 111M-8, 111M-9 |  |  |
| BE-8910, BE-8915, BE-8920, BE-8925,<br>BE-8930  |  |  |
| BE-8020, BE-8040  |  |  |
| BE-8155   |  |  |
| BE-8355   |  |  |
| BE-8602   |  |  |
| BE-8611, BE-8621  |  |  |
| BE-8811, BE-8821  |  |  |
| BE-8802   |  |  |

Fit&Go 3/3 Foam Laser Marked Inlay Striking, Cutting, Files & L-Keys - 36 pcs



### FF1A216LM

40 x 445 x 543 mm 1 FF1A216LM

|                                   |  |  |
|-----------------------------------|--|--|
| 1-100-08-2-2                      |  |  |
| 1-210-08-2-2                      |  |  |
| 1-230-08-2-2                      |  |  |
| 3734-3, 3734-4, 3734-5            |  |  |
| 3735-4-120                        |  |  |
| 481-400                           |  |  |
| BE-8986                           |  |  |
| BE-9770                           |  |  |
| S4RM-8-11, S4RM-12-15, S4RM-16-19 |  |  |
| KB18-01                           |  |  |

### KSBG18-10DISPEN

|          |  |  |
|----------|--|--|
| MTG-3-16 |  |  |
| WR2-MM   |  |  |
| 3740-200 |  |  |
| 317      |  |  |

Fit&Go 3/3 Foam Laser Marked Inlay Window Click Torque Wrench, Spark Plug Sockets & 1/4" Socket Set - 79 pcs



### FF1A218LM

45 x 445 x 543 mm 1 FF1A218LM

|  |  |  |
|--|--|--|
| 1178-SCRIBE  |  |  |
| 1547   |  |  |
| 74WR-200   |  |  |
| 7805ZZ-16, 7805ZZ-21   |  |  |
| BBR201P64014, BBR201P64016,<br>BBR201P64018, BBR201P67814,<br>BBR201P67816, BBR201P67818 |  |  |
| BWSS12P3   |  |  |
| MTC-3-13-C1  |  |  |
| 7800SM-34, 7800SM-36   |  |  |
| SL25L  |  |  |
| SR200-MM   |  |  |
| S240   |  |  |

Fit&Go 3/3 Foam Laser Marked Inlay 1/2" Deep Socket & Socket Hex Bits Set - 49 pcs



### FF1A219LM

35 x 445 x 543 mm 1 FF1A219LM

|              |  |  |
|--------------|--|--|
| 1-100-08-2-2 |  |  |
| S1612L       |  |  |
| S18HEX       |  |  |
| S18TORX      |  |  |





Fit&Go 3/3 Foam Laser Marked Inlay Combination Spanner Set & Adjustable Spanner - 21 pcs



**FF1A220LM**



35 x 445 x 543 mm

1 FF1A220LM

111M-10, 111M-11, 111M-12, 111M-13, 111M-14, 111M-15, 111M-16, 111M-17, 111M-18, 111M-19, 111M-20, 111M-21, 111M-22, 111M-23, 111M-24, 111M-27, 111M-30, 111M-32, 111M-8, 111M-9

8071

Fit&Go 3/3 Foam Laser Marked Inlay Ratcheting Combination Spanner, Swivel Head Spanner & L-Keys Sets - 42 pcs



**FF1A221LM**



40 x 445 x 543 mm

1 FF1A221LM

1RM-10, 1RM-11, 1RM-12, 1RM-13, 1RM-14, 1RM-17, 1RM-19, 1RM-8

2681

4040M-10-11, 4040M-12-13, 4040M-14-15, 4040M-16-17, 4040M-18-19, 4040M-8-9

8045LVDE

806-1-1

808050

808050S

9715-14-250

BE-9575

BE-9770

Fit&Go 3/3 Foam Laser Marked Inlay ERGO™ Screwdrivers, Caliper, Bit Set & 1/2" Impact Socket Set - 65 pcs



**FF1A222LM**



45 x 445 x 543 mm

1 FF1A222LM

BE-7805, BE-7806, BE-7807, BE-7808, BE-7809, BE-7810, BE-7811, BE-7813, BE-7855

D/S14

K8160D-1, K8160D-2

K8167S

BE-8135TB, BE-8145TB, BE-8150TB, BE-8155TB

BE-8610TB, BE-8620TB, BE-8623TB

1150-1/2H/P

59/S31B

Fit&Go 3/3 Foam Laser Marked Inlay Pliers & T-Type Hex Key Spanners - 15 pcs



**FF1A223LM**



35 x 445 x 543 mm

1 FF1A223LM

5226 DC

158-N

158-NB

21HDG-200

2430 G-190HD

2628G-200IP

2968-190

8224 IP

BE1P

BE1TH-2.5, BE1TH-3, BE1TH-4, BE1TH-5, BE1TH-6, BE1TH-8

Fit&Go 3/3 Foam Laser Marked Inlay Striking, Cutting & Hose Clamp Set - 26 pcs



**FF1A224LM**



40 x 445 x 543 mm

1 FF1A224LM

1435/8

319

3625S-35

3734S/6

3735-5-150

3740-200

3750

3906-300-24-2P

479-16

KBFU-01

BE256P3

Fit&Go 3/3 Foam Laser Marked Inlay Awls, Hooks, Scraper, Magnetic Pick Up Tool & Torx Bits Set - 60 pcs



**FF1A225LM**



40 x 445 x 543 mm

1 FF1A225LM

2487

2535F1

2633/S4

2485

782-U

BE5049T

BE66152

2484-45

5515T-52

Fit&Go 3/3 Foam Inlay 1/4" + 1/2" Screwdriver/Socket Set - 77 Pcs



**FF1A01**



45 x 445 x 543 mm



1 FF1A01



A6800DM-4, A6800DM-5, A6800DM-6, A6800DM-7, A6800DM-8, A6800DM-9, A6800DM-10, A6800DM-11, A6800DM-12, A6800DM-13



6700SM-4.5, 6700SM-5, 6700SM-5.5, 6700SM-6, 6700SM-7, 6700SM-8, 6700SM-9, 6700SM-10, 6700SM-11, 6700SM-12, 6700SM-13, 6700SM-4



59S/22-1



6950SL



6954



6956



6960, 6961



6966



6972H



7800SM-18, 7800SM-19, 7800SM-10, 7800SM-11, 7800SM-12, 7800SM-13, 7800SM-14, 7800SM-15, 7800SM-16, 7800SM-17, 7800SM-22, 7800SM-27, 7800SM-24, 7800SM-30, 7800SM-32



7805ZZ-21



7807H



B191.040.100, B191.055.150



B192.001.100, B192.002.125



8150SL



8154-11



8160-3, 8160-10



8166



Fit&Go 3/3 Foam Inlay Combination and Double Open End Wrench Set - 19 Pcs



**FF1A02**



45 x 445 x 543 mm



1 FF1A02



111M-12, 111M-13, 111M-14, 111M-17, 111M-19, 111M-22, 111M-6, 111M-7, 111M-8, 111M-10



6M-6-7, 6M-8-9, 6M-10-11, 6M-12-13, 6M-14-15, 6M-16-17, 6M-18-19, 6M-20-22



808050L



Fit&Go 3/3 Foam Inlay Pliers/Striking/Measuring Toolset - 18 Pcs



**FF1A03**



50 x 445 x 543 mm



1 FF1A03



BE-9770



MTB-5-25



3734N-4-150, 3734N-6-150



1-100-08-2-2



2171G-160



2971G-250



481-400



2678 G-160



306



Fit&Go 3/3 Foam Inlay Adjustable/Combination/Double Open End Wrench Set - 30 Pcs



**FF1A04**



50 x 445 x 543 mm



1 FF1A04



S4RM-12-15, S4RM-16-19, S4RM-8-11



111M-30, 111M-32, 111M-6, 111M-7, 111M-8, 111M-9, 111M-10, 111M-11, 111M-12, 111M-13, 111M-14, 111M-15, 111M-16, 111M-17, 111M-18, 111M-19, 111M-21, 111M-22, 111M-24, 111M-27



6M-10-11, 6M-12-13, 6M-14-15, 6M-17-19, 6M-6-7, 6M-8-9



9071C



Fit&Go 3/3 Foam Laser Marked Inlay 1/2" & 1/4" Sockets Ratcheting Screwdriver & Bit Set - 104 pcs



**FF1A051**



50 x 445 x 543 mm



1 FF1A051

BE-9678



SBS60-4, SBS60-4.5, SBS60-5, SBS60-5.5, SBS60-6, SBS60-7, SBS60-8, SBS60-9, SBS60-10, SBS60-11, SBS60-12, SBS60-13, SBS60-14



SBS61



SBS63-2, SBS63-4, SBS63-6



SBS65



SBS67



SBS69



7800SM-10, 7800SM-11, 7800SM-12, 7800SM-13, 7800SM-14, 7800SM-15, 7800SM-16, 7800SM-18, 7800SM-19, 7800SM-21, 7800SM-17, 7800SM-22, 7800SM-24, 7800SM-27, 7800SM-32, 7800SM-30



SBS88



59S/31-1



6956



6972H



7809M-5, 7809M-6, 7809M-7, 7809M-8, 7809M-10, 7809M-12, 7809M-14, 7809M-17, 7809M-19



7809TORX-T20, 7809TORX-T25, 7809TORX-T27, 7809TORX-T30, 7809TORX-T40, 7809TORX-T45, 7809TORX-T50, 7809TORX-T55, 7809TORX-T60



808050



8150SL



8154-11



8160-W



8160-10



8166



6954





Fit&Go 3/3 Foam Inlay Screwdriver/Pliers Set - 23 Pcs



**FF1A06**

45 x 445 x 543 mm 1 FF1A06

|  |  |  |
|--|--|--|
| BE-8020L, BE-8040                                    |  |  |
| BE-8150, BE-8255, BE-8256                            |  |  |
| BE-8350  |  |  |
| BE-8601  |  |  |
| BE-8610, BE-8620                                     |  |  |
| BE-8910, BE-8915, BE-8920, BE-8925, BE-8927, BE-8930 |  |  |
| MTB-3-16   |  |  |
| 2101G-160IP  |  |  |
| 2427 G-200 IP  |  |  |
| 2535L  |  |  |
| 2628 G-160IP   |  |  |
| 2951-180   |  |  |
| 5515T-52   |  |  |
| 8224 IP  |  |  |

Fit&Go 3/3 Foam Inlay File/Striking Toolset with Hacksaw Frame - 15 Pcs



**FF1A07**

40 x 445 x 543 mm 1 FF1A07

|                                       |  |
|---------------------------------------|--|
| 3734N-3-150, 3734N-5-150, 3734N-6-150 |  |
| 3735N-4-120                           |  |
| 3740-175                              |  |
| SQZ150003                             |  |
| 1-100-08-2-2                          |  |
| 1-210-08-2-2                          |  |
| 1-230-08-2-2                          |  |
| 2744                                  |  |
| 3625W-35                              |  |

|          |  |
|----------|--|
| 3745-150 |  |
| 481-400  |  |
| 782-U    |  |
| 317      |  |

Fit&Go 3/3 Foam Inlay 1/4" + 1/2" + 3/8" Socket and Pear Head Ratchet Set - 138 Pcs



**FF1A08**

60 x 445 x 543 mm 1 FF1A08

|   |  |
|---|--|
| A6800DM-5.5, A6800DM-6, A6800DM-7, A6800DM-8, A6800DM-9, A6800DM-10, A6800DM-11, A6800DM-12, A6800DM-13   |  |
| A7402DM-10, A7402DM-11, A7402DM-12, A7402DM-13, A7402DM-14, A7402DM-15, A7402DM-16, A7402DM-17, A7402DM-18, A7402DM-19  |  |
| 1544  |  |
| 2058-BR   |  |
| 6700SM-5.5, 6700SM-6, 6700SM-7, 6700SM-8, 6700SM-9, 6700SM-10, 6700SM-11, 6700SM-12, 6700SM-13  |  |
| 6709M-3, 6709M-4, 6709M-5, 6709M-6, 6709M-8   |  |
| 6709PH-1, 6709PH-2, 6709PH-3  |  |
| 6709TORX-T20, 6709TORX-T25, 6709TORX-T27, 6709TORX-T30, 6709TORX-T40, 6709TORX-T8, 6709TORX-T9, 6709TORX-T10, 6709TORX-T15                                      |  |
| 6950SL  |  |
| 6954  |  |
| 6956  |  |
| 6958  |  |
| 6960, 6961, 6962, 6962L   |  |
| 6966  |  |
| 6972H   |  |
| 7400SM-6, 7400SM-7, 7400SM-8, 7400SM-9, 7400SM-10, 7400SM-11, 7400SM-12, 7400SM-13, 7400SM-14, 7400SM-15, 7400SM-16, 7400SM-17, 7400SM-18, 7400SM-19, 7400SM-22 |  |
| 7407H   |  |
| 7409M-3, 7409M-4, 7409M-5, 7409M-6, 7409M-7, 7409M-8, 7409M-10  |  |
| 7409TORX-T25, 7409TORX-T27, 7409TORX-T30, 7409TORX-T40, 7409TORX-T45, 7409TORX-T50  |  |
| 7750SL  |  |
| 7754  |  |
| 7758  |  |
| 7760, 7761, 7762  |  |
| 7764  |  |
| 7765  |  |

|  |  |
|--|--|
| 7766   |  |
| 7800SM-10, 7800SM-11, 7800SM-12, 7800SM-13, 7800SM-14, 7800SM-15, 7800SM-16, 7800SM-17, 7800SM-18, 7800SM-19, 7800SM-21, 7800SM-22, 7800SM-24, 7800SM-27, 7800SM-30, 7800SM-32 |  |

|  |  |
|--|--|
| 7807H  |  |
| 7809M-5, 7809M-6, 7809M-7, 7809M-8, 7809M-10, 7809M-12, 7809M-14, 7809M-17, 7809M-19 |  |

|  |  |
|--|--|
| 7809TORX-T20, 7809TORX-T25, 7809TORX-T27, 7809TORX-T30, 7809TORX-T40, 7809TORX-T45, 7809TORX-T55, 7809TORX-T50, 7809TORX-T60 |  |
|--|--|

|                 |  |
|-----------------|--|
| 8150SL          |  |
| 8164-1/2        |  |
| 8154-11         |  |
| 8160-5, 8160-10 |  |
| 8171            |  |
| 8166            |  |
| 8172            |  |

Fit&Go 3/3 Foam Inlay Adjustable/Combination/Double Open End Wrench Set - 34 Pcs



**FF1A09**

50 x 445 x 543 mm 1 FF1A09

|  |  |
|--|--|
| 111M-30, 111M-32, 111M-6, 111M-7, 111M-8, 111M-9, 111M-10, 111M-11, 111M-12, 111M-13, 111M-14, 111M-15, 111M-16, 111M-17, 111M-18, 111M-19, 111M-21, 111M-22, 111M-24, 111M-27 |  |
| 1320RM-10-11, 1320RM-12-13, 1320RM-8-9   |  |
| 6M-6-7, 6M-8-9, 6M-10-11, 6M-12-13, 6M-14-15, 6M-16-17, 6M-18-19, 6M-20-22, 6M-24-27, 6M-30-32   |  |
| 9071C  |  |

Fit&Go 3/3 Foam Inlay T-Handle + L-Key Screwdriver Set - 19 Pcs



**FF1A1004**

38 x 445 x 543 mm 1 FF1A1004

|  |  |
|--|--|
| 900T-050-150, 900T-020-100, 900T-025-100, 900T-030-100, 900T-040-150, 900T-060-200, 900T-080-200, 900T-100-200 |  |
| BE-9777B   |  |

Fit&Go 3/3 T-Handle Screwdriver Set - 54 Pcs



**FF1A1010**

51 x 445 x 543 mm 1 FF1A1010

|  |  |
|--|--|
| 901T-010-100, 901T-015-150, 901T-020-150, 901T-025-150, 901T-027-150, 901T-030-200, 901T-040-200 |  |
| 808050   |  |
| 1419-MD  |  |
| 7805DM-10, 7805DM-12, 7805DM-13, 7805DM-17, 7805DM-19  |  |
| BE-9678  |  |
| 59S/31-1   |  |

Fit&Go 3/3 Hex/TORX T-Handle Screwdriver Set - 12 Pcs

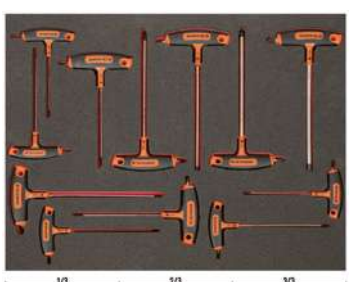

**FF1A1011**

35 x 445 x 543 mm 1 FF1A1011

|        |  |
|--------|--|
| 903T-2 |  |
| 903T-1 |  |

Fit&Go 3/3 Foam Inlay Combination Wrenches and Pliers Set - 82 Pcs



**FF1A102**

40 x 445 x 543 mm 1 FF1A102

|   |  |
|---|--|
| 111M-32, 111M-8, 111M-9, 111M-10, 111M-11, 111M-12, 111M-13, 111M-14, 111M-15, 111M-16, 111M-17, 111M-18, 111M-19, 111M-21, 111M-22, 111M-24, 111M-27 |  |
| 7224  |  |
| 2800-180  |  |
| 2900-180  |  |
| 2890-180  |  |
| 2990-180  |  |
| 2101G-180   |  |
| 2628 G-180IP  |  |

Fit&Go 3/3 Foam Inlay Wrench and Bits Set - 19 Pcs



**FF1A104**

35 x 445 x 543 mm 1 FF1A104

|   |  |
|---|--|
| 111M-32, 111M-7, 111M-8, 111M-9, 111M-10, 111M-11, 111M-12, 111M-13, 111M-14, 111M-15, 111M-16, 111M-17, 111M-18, 111M-19, 111M-21, 111M-22, 111M-24, 111M-27 |  |
| 59/S54BC  |  |

Fit&Go 3/3 Foam Inlay Socket Set - 93 Pcs



**FF1A106**

55 x 543 x 445 mm 1 FF1A106

|       |  |
|-------|--|
| S87+7 |  |
|-------|--|

Fit&Go 3/3 Foam Inlay Pliers Set - 16 Pcs



**FF1A11**

43 x 543 x 445 mm 1 FF1A11

|                              |  |
|------------------------------|--|
| 2101GC-125IP, 2101GC-160IP   |  |
| 21HDGC-200IP                 |  |
| 2427 GC-200IP                |  |
| 2430 GC-200 IP               |  |
| 2628 GC-160IP                |  |
| 2928-160, 2928-200, 2928-250 |  |
| 2951-250                     |  |
| 2952-165                     |  |
| 8224CIP                      |  |
| BFLA01                       |  |



Fit&Go 3/3 Foam Inlay Striking and Cutting Toolset - 11 Pcs



**FF1A110**



50 x 445 x 543 mm



1 FF1A110

|           |  |
|-----------|--|
| 2535L     |  |
| 426TOR9   |  |
| 9572-200  |  |
| MTB-8-25  |  |
| SQZ150003 |  |
| 3875-LY3  |  |
| 479-24    |  |
| 481-400   |  |
| 529-20-L  |  |
| 225-PLUS  |  |
| 208       |  |

Fit&Go 3/3 Foam Inlay Wrench/Adjustable Wrench Set - 22 Pcs



**FF1A112**



35 x 445 x 543 mm



1 FF1A112

|   |  |
|---|--|
| S4RM/3T   |  |
| 111M-6, 111M-7, 111M-8, 111M-9, 111M-10, 111M-11, 111M-12, 111M-13, 111M-14, 111M-15, 111M-16, 111M-17, 111M-18, 111M-19, 111M-20, 111M-21, 111M-22, 111M-24, 111M-27 |  |
| 9031  |  |
| 9070  |  |

Fit&Go 3/3 Foam Inlay Pliers and Striking Toolset - 18 Pcs



**FF1A114**



42 x 445 x 543 mm



1 FF1A114

|  |  |
|--|--|
| 8224 IP  |  |
| 2632   |  |
| 3734-2, 3734-3, 3734-4, 3734-5, 3734-6, 3734-8 |  |
| 2800-180                                       |  |
| 2890-180                                       |  |
| 2900-180                                       |  |
| 2990-180                                       |  |
| 4611-2   |  |
| 479-24   |  |
| 1435/5   |  |
| 1178-SCRIBE                                    |  |
| 2430 G-160 IP                                  |  |
| 2101G-180IP                                    |  |

Fit&Go 3/3 Foam Inlay Measuring and Cutting Toolset - 9 Pcs



**FF1A115**



35 x 445 x 543 mm



1 FF1A115

|              |  |
|--------------|--|
| 1-210-08-1-2 |  |
| 9045-B-250   |  |
| 406T-225     |  |
| MTB-5-25     |  |
| BFLA01       |  |
| K-AP-1       |  |
| 268          |  |
| 5515T-52     |  |
| 319          |  |

Fit&Go 3/3 Foam Inlay Wrench and Screwdriver Set - 26 Pcs



**FF1A117**



35 x 445 x 543 mm



1 FF1A117

|   |  |
|---|--|
| B191.040.100  |  |
| B190.055.125, B190.065.150  |  |
| B192.000.075, B192.001.100, B192.002.125  |  |
| 111M-32, 111M-6, 111M-7, 111M-8, 111M-9, 111M-10, 111M-11, 111M-12, 111M-13, 111M-14, 111M-15, 111M-16, 111M-17, 111M-18, 111M-19, 111M-21, 111M-22, 111M-24, 111M-27 |  |
| 8073 IP   |  |

Fit&Go 3/3 Foam Inlay Pliers and File Set - 14 Pcs



**FF1A118**



35 x 445 x 543 mm



1 FF1A118

|               |  |
|---------------|--|
| 1-100-08-2-2  |  |
| 2430 G-160 IP |  |
| 2628G-200IP   |  |
| 2800-180      |  |
| 2900-180      |  |
| 2890-180      |  |
| 2990-180      |  |
| 5515T         |  |
| 1-170-08-2-2  |  |
| 1-210-08-2-2  |  |
| 1-230-08-2-2  |  |
| 2535F1        |  |
| 8224 IP       |  |
| 2101G-180IP   |  |



Fit&Go 3/3 Foam Inlay Striking and Cutting Toolset - 10 Pcs



**FF1A119**



47 x 445 x 543 mm



1 FF1A119



|              |  |
|--------------|--|
| 3734S/6      |  |
| 481-300      |  |
| KGAU-01      |  |
| MTB-5-25-M-E |  |
| 137-10       |  |
| 1150-1/2H/P  |  |
| 426TOR9      |  |
| BLTS10       |  |
| 375-8        |  |
| 319          |  |

Fit&Go 3/3 Foam Inlay Striking and File Set - 19 Pcs



**FF1A12**



35 x 445 x 543 mm



1 FF1A12



|                            |  |
|----------------------------|--|
| FS-8                       |  |
| 1-100-06-1-2, 1-100-06-2-2 |  |
| 1-160-06-1-2               |  |
| 1-210-06-1-2               |  |
| 1-230-06-1-2               |  |
| 2509                       |  |
| 2535F2                     |  |
| 3625W-35                   |  |
| 3734-3, 3734-5, 3734-8     |  |
| 3735-4-120                 |  |
| 3740-150                   |  |
| 3745-150                   |  |
| 481-300, 481-500           |  |
| 319                        |  |
| 8157-15                    |  |

Fit&Go 3/3 Foam Inlay Wrench/Pliers Set - 28 Pcs



**FF1A121**



40 x 445 x 543 mm



1 FF1A121



|   |  |
|---|--|
| 111M-8, 111M-9, 111M-10, 111M-11, 111M-12, 111M-13, 111M-14, 111M-15, 111M-16, 111M-17, 111M-18, 111M-19, 111M-22 |  |
| 2470 G-200  |  |
| 7224  |  |
| 2953-250  |  |
| 6M-6-7, 6M-8-9, 6M-10-11, 6M-12-13, 6M-14-15, 6M-16-17, 6M-18-19, 6M-20-22  |  |
| 2800-180  |  |
| 2900-180  |  |
| 2101G-160IP   |  |

Fit&Go 3/3 Foam Inlay Wrench/Screwdriver Set - 25 Pcs



**FF1A124**



45 x 445 x 543 mm



1 FF1A124



|   |  |
|---|--|
| B191.040.100  |  |
| B190.055.125, B190.065.150  |  |
| B192.000.075, B192.001.100, B192.002.125  |  |
| 111M-32, 111M-6, 111M-7, 111M-8, 111M-9, 111M-10, 111M-11, 111M-12, 111M-13, 111M-14, 111M-15, 111M-16, 111M-17, 111M-18, 111M-19, 111M-21, 111M-22, 111M-24, 111M-27 |  |

Fit&Go 3/3 Foam Inlay Striking/Cutting Toolset - 11 Pcs



**FF1A127**



35 x 445 x 543 mm



1 FF1A127



|                 |  |
|-----------------|--|
| 3734S/6         |  |
| 479-16          |  |
| 3625W-35        |  |
| MTG-3-16        |  |
| KB18-01         |  |
| KSBG18-10DISPEN |  |
| 8224 IP         |  |
| 2101G-160IP     |  |
| 2628 G-180IP    |  |
| 2430 G-200 IP   |  |
| 2530            |  |

Fit&Go 3/3 Foam Inlay Wrench/File Set - 18 Pcs



**FF1A128**



65 x 445 x 543 mm



1 FF1A128



|   |  |
|---|--|
| 9029, 9031  |  |
| 111Z-1/4, 111Z-5/16, 111Z-3/8, 111Z-7/16, 111Z-1/2, 111Z-9/16, 111Z-5/8, 111Z-11/16, 111Z-3/4, 111Z-13/16, 111Z-7/8, 111Z-1 |  |
| 1-473-08-2-2  |  |
| 361-12  |  |
| 2633/S4   |  |
| S4RM/5T   |  |



Fit&Go 3/3 Foam Inlay Pliers/Screwdriver Set - 16 Pcs



**FF1A129**

45 x 445 x 543 mm 1 FF1A129

|  |  |
|--|--|
| 2171G-180                                |  |
| 2470 G-200                               |  |
| 2477 G-200                               |  |
| 9033, 9035                               |  |
| 1520 G                                   |  |
| 808050P                                  |  |
| B191.040.100                             |  |
| B190.055.125, B190.065.150               |  |
| B192.000.075, B192.001.100, B192.002.125 |  |
| BE-9777B                                 |  |
| 2678 G-200                               |  |
| 59S/31-1                                 |  |

Fit&Go 3/3 Foam Inlay 1/4" + 3/8" Socket and Pear Head Ratchet Set - 83 Pcs



**FF1A131**

55 x 445 x 543 mm 1 FF1A131

|  |  |
|--|--|
| A6700DZ-1/2, A6700DZ-1/4, A6700DZ-11/32, A6700DZ-3/16, A6700DZ-3/8, A6700DZ-5/16, A6700DZ-7/16, A6700DZ-7/32, A6700DZ-9/16, A6700DZ-9/32   |  |
| A6710DZ-1/2, A6710DZ-1/4, A6710DZ-11/32, A6710DZ-3/16, A6710DZ-3/8, A6710DZ-5/16, A6710DZ-7/16, A6710DZ-7/32, A6710DZ-9/16, A6710DZ-9/32   |  |
| A6800DM-4, A6800DM-10  |  |
| A6800DZ-1/2, A6800DZ-1/4, A6800DZ-11/32, A6800DZ-3/16, A6800DZ-3/8, A6800DZ-5/16, A6800DZ-7/16, A6800DZ-7/32, A6800DZ-9/16, A6800DZ-9/32   |  |
| A7400DZ-1/2, A7400DZ-1/4, A7400DZ-11/16, A7400DZ-13/16, A7400DZ-17/32, A7400DZ-19/32, A7400DZ-3/4, A7400DZ-3/8, A7400DZ-5/16, A7400DZ-5/8, A7400DZ-7/16, A7400DZ-7/8, A7400DZ-9/16 |  |

|   |  |
|---|--|
| A7402DZ-1/2, A7402DZ-1/4, A7402DZ-11/16, A7402DZ-13/16, A7402DZ-19/32, A7402DZ-3/4, A7402DZ-3/8, A7402DZ-5/16, A7402DZ-5/8, A7402DZ-7/16, A7402DZ-7/8, A7402DZ-9/16 |  |
| 6700SZ-5/32   |  |
| 6950SL  |  |
| 6954  |  |
| 6956  |  |
| 6958  |  |
| 6960, 6961, 6962, 6962L   |  |
| 6966  |  |
| 6972H   |  |
| 7407H, 7408H  |  |
| 7750SL  |  |
| 7752  |  |
| 7754  |  |
| 7758  |  |
| 7760, 7761, 7762  |  |
| 7764  |  |
| 7765  |  |
| 7766  |  |
| 8164-1/2  |  |
| U-S6106KA   |  |
| 8171  |  |

Fit&Go 3/3 Foam Inlay Socket/Bit Set - 53 Pcs



**FF1A130**

45 x 445 x 543 mm 1 FF1A130

|   |  |
|---|--|
| 7800SM-8, 7800SM-9, 7800SM-10, 7800SM-11, 7800SM-12, 7800SM-13, 7800SM-14, 7800SM-15, 7800SM-16, 7800SM-17, 7800SM-18, 7800SM-19, 7800SM-21, 7800SM-22, 7800SM-23, 7800SM-24, 7800SM-27, 7800SM-30, 7800SM-32 |  |
| 8150SL  |  |
| SBS87S, SBS87   |  |
| SBS83-3, SBS83-5, SBS83-10  |  |
| SBS85   |  |
| SBS86   |  |
| SBS88   |  |
| SBS89   |  |
| 7809TORX-T20, 7809TORX-T25, 7809TORX-T27, 7809TORX-T30, 7809TORX-T40, 7809TORX-T45, 7809TORX-T50, 7809TORX-T55, 7809TORX-T60  |  |

|   |  |
|---|--|
| 7809M-5, 7809M-6, 7809M-7, 7809M-8, 7809M-9, 7809M-10, 7809M-12, 7809M-14, 7809M-17, 7809M-19 |  |
| 7809M-5-180, 7809M-6-140, 7809M-7-100, 7809M-8-120, 7809M-10-140                              |  |

Fit&Go 3/3 Foam Inlay Mixed Tightening/Measuring Toolset - 10 Pcs



**FF1A131**

40 x 445 x 543 mm 1 FF1A131

|  |  |
|--|--|
| SQZ150003                                      |  |
| FS-8   |  |
| SQZ150003-SBL                                  |  |
| 481-400  |  |
| 3734-2, 3734-4, 3734-5, 3734-6, 3734-8, 3734-3 |  |
| 3735-5-120                                     |  |
| 3740-175                                       |  |
| BE-9678  |  |
| 1547   |  |
| 319  |  |
| 208  |  |
| 3625N-32                                       |  |

Fit&Go 3/3 Foam Inlay Mixed Sockets/File Set - 31 Pcs











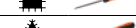

**FF1A132**

40 x 445 x 543 mm 1 FF1A132

|  |  |
|--|--|
| 7400SM-6, 7400SM-7, 7400SM-8, 7400SM-9, 7400SM-10, 7400SM-11, 7400SM-12, 7400SM-13, 7400SM-14, 7400SM-15, 7400SM-16, 7400SM-17, 7400SM-18, 7400SM-19 |  |
| 7750SL   |  |
| SBS705   |  |





|                        |   |
|------------------------|---|
| SBS755                 |  |
| SBS723, SBS724         |  |
| SBS775                 |  |
| SBS760, SBS761, SBS762 |  |
| 1-100-08-1-2           |  |
| 1-160-08-1-2           |  |
| 1-170-08-2-2           |  |
| 1-210-08-1-2           |  |
| 1-230-08-1-2           |  |
| 2635                   |  |
| 1150D                  |  |
| 2681                   |  |



Fit&Go 3/3 Foam Inlay Screwdriver Set - 17 Pcs



**FF1A133**



35 x 445 x 543 mm 1 FF1A133

|  |   |
|--|---|
| 900T-020-100, 900T-025-100, 900T-030-100, 900T-040-150, 900T-050-150, 900T-060-200, 900T-080-200, 900T-100-200               |  |
| B194.006.075, B194.007.075, B194.008.075, B194.009.075, B194.010.075, B194.015.100, B194.020.100, B194.025.125, B194.030.150 |  |

Fit&Go 3/3 Foam Inlay Combination Wrench Set - 21 Pcs



**FF1A134**

37 x 445 x 543 mm 1 FF1A134

|   |   |
|---|---|
| 111M-30, 111M-32, 111M-6, 111M-7, 111M-8, 111M-9, 111M-10, 111M-11, 111M-12, 111M-13, 111M-14, 111M-15, 111M-16, 111M-17, 111M-18, 111M-19, 111M-20, 111M-21, 111M-22, 111M-24, 111M-27 |  |
|---|---|



Fit&Go 3/3 Foam Inlay Wrench/Bit Set - 51 Pcs



**FF1A135**

40 x 445 x 543 mm 1 FF1A135

|  |   |
|--|---|
| 4040M-8-9, 4040M-10-11, 4040M-12-13, 4040M-14-15, 4040M-16-17, 4040M-18-19, 4040M-20-22, 4040M-21-23               |  |
| 59S/31-1   |  |
| 6M-6-7, 6M-8-9, 6M-10-11, 6M-12-13, 6M-14-15, 6M-16-17, 6M-18-19, 6M-20-22, 6M-21-23, 6M-24-27, 6M-25-28, 6M-30-32 |  |













Fit&Go 3/3 Foam Inlay 1/4" Socket/Pliers/Screwdriver Set - 40 Pcs











**FF1A136**

40 x 445 x 543 mm 1 FF1A136

|   |  |
|---|--|
| 2628 G-180  |  |
| 2430 G-160  |  |
| 8224  |  |
| 2101G-160   |  |
| 6700SM-4.5, 6700SM-5, 6700SM-5.5, 6700SM-6, 6700SM-7, 6700SM-8, 6700SM-9, 6700SM-10, 6700SM-11, 6700SM-12, 6700SM-13, 6700SM-14, 6700SM-4 |   |
| 6950SL  |  |
| SBS67   |  |
| SBS69   |  |
| SBS65   |  |
| SBS63-2, SBS63-4, SBS63-6   |  |
| 2800-180  |   |
| 2890-180  |   |

|  |   |
|--|---|
| 2900-180                                 |  |
| 2990-180                                 |  |
| B191.030.075, B191.040.100               |  |
| B190.055.100, B190.065.125, B190.080.150 |  |
| B195.050.025                             |  |
| B195.001.025                             |  |
| B192.001.100, B192.002.125               |  |
| 808050                                   |  |
| 6954                                     |  |

















Fit&Go 3/3 Foam Inlay Socket and Round Head Ratchet Set - 59 Pcs



**FF1A137**

50 x 445 x 543 mm 1 FF1A137

|   |   |
|---|---|
| 7800SM-8, 7800SM-9, 7800SM-10, 7800SM-11, 7800SM-12, 7800SM-13, 7800SM-14, 7800SM-15, 7800SM-16, 7800SM-17, 7800SM-18, 7800SM-19, 7800SM-21, 7800SM-22, 7800SM-23, 7800SM-24, 7800SM-27, 7800SM-30, 7800SM-32 |  |
| 8150SL  |  |
| SBS87S, SBS87   |  |
| SBS83-3, SBS83-5, SBS83-10  |  |
| SBS85   |  |
| SBS86   |  |
| SBS88   |  |
| SBS89   |  |
| 7809TORX-T50, 7809TORX-T20, 7809TORX-T25, 7809TORX-T27, 7809TORX-T30, 7809TORX-T40, 7809TORX-T45, 7809TORX-T55, 7809TORX-T60  |  |
| 6700SM-4, 6700SM-4.5, 6700SM-5, 6700SM-5.5, 6700SM-6, 6700SM-7, 6700SM-8, 6700SM-9, 6700SM-10, 6700SM-11, 6700SM-12, 6700SM-13, 6700SM-14   |  |
| 6950SL  |  |
| SBS67   |  |
| SBS69   |  |
| SBS65   |  |
| SBS63-2, SBS63-4, SBS63-6   |  |
| 6954  |  |



Fit&Go 3/3 Foam Inlay Mixed Striking/  
Cutting Toolset - 16 Pcs



**FF1A138**

40 x 445 x 543 mm 1 FF1A138

|  |  |
|--|--|
| SQZ150003                                      |  |
| FS-8   |  |
| SQZ150003-SBL                                  |  |
| 481-400  |  |
| 3734-2, 3734-3, 3734-4, 3734-5, 3734-6, 3734-8 |  |
| 3735-5-120                                     |  |
| 3740-175                                       |  |
| BE-9678  |  |
| 319  |  |
| 208  |  |
| 3625N-32                                       |  |

Fit&Go 3/3 Foam Inlay Screwdriver Set -  
18 Pcs



**FF1A139**

38 x 445 x 543 mm 1 FF1A139

|  |  |
|--|--|
| 808050   |  |
| 900T-020-100, 900T-025-100, 900T-030-100, 900T-040-150, 900T-050-150, 900T-060-200, 900T-080-200, 900T-100-200 |  |
| B191.030.075, B191.040.100   |  |
| B190.055.100, B190.065.125, B190.080.150   |  |
| B195.050.025   |  |
| B195.001.025   |  |
| B192.001.100, B192.002.125   |  |

Fit&Go 3/3 Foam Inlay Imperial  
Combination and Double Open End  
Wrench Set - 43 Pcs



**FF1A14**

46 x 445 x 543 mm 1 FF1A14

|   |  |
|---|--|
| 111Z-1, 111Z-1/2, 111Z-1/4, 111Z-11/16, 111Z-13/16, 111Z-15/16, 111Z-3/4, 111Z-3/8, 111Z-5/16, 111Z-5/8, 111Z-7/16, 111Z-7/8, 111Z-9/16                 |  |
| 1320RZ-1/2-9/16, 1320RZ-1/4-5/16, 1320RZ-3/8-7/16, 1320RZ-5/16-11/32  |  |
| 1931Z-1/2, 1931Z-1/4, 1931Z-11/32, 1931Z-3/16, 1931Z-3/8, 1931Z-5/16, 1931Z-5/32, 1931Z-7/16, 1931Z-7/32, 1931Z-9/16, 1931Z-9/32                        |  |
| 1950MZ-3/8  |  |
| 1952Z-11/32   |  |
| 6Z-1.1/16-1.1/4, 6Z-1.1-1/8, 6Z-1/2-9/16, 6Z-1/4-5/16, 6Z-15/16-1, 6Z-19/32-11/16, 6Z-25/32-13/16, 6Z-3/8-7/16, 6Z-5/16-11/32, 6Z-5/8-3/4, 6Z-7/8-15/16 |  |
| 8069 C IP   |  |
| 9070C   |  |

Fit&Go 3/3 Foam Inlay Mixed Wrench/  
Pliers Set - 46 Pcs

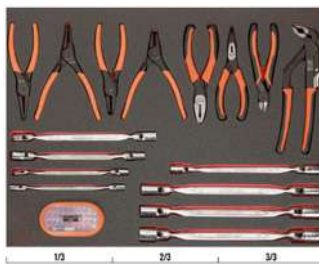

**FF1A141**

42 x 445 x 543 mm 1 FF1A141

|            |  |
|------------|--|
| 2628 G-180 |  |
| 2430 G-160 |  |
| 8224       |  |
| 2101G-160  |  |
| 2800-180   |  |
| 2890-180   |  |
| 2900-180   |  |
| 2990-180   |  |

4040M-8-9, 4040M-10-11, 4040M-12-13, 4040M-14-15, 4040M-16-17, 4040M-18-19, 4040M-20-22, 4040M-21-23

59S/31-1

Fit&Go 3/3 Foam Inlay Measuring Tapes/  
Socket/Bit Set - 71 Pcs



**FF1A142**

50 x 445 x 543 mm 1 FF1A142

7800SM-8, 7800SM-9, 7800SM-10, 7800SM-11, 7800SM-12, 7800SM-13, 7800SM-14, 7800SM-15, 7800SM-16, 7800SM-17, 7800SM-18, 7800SM-19, 7800SM-21, 7800SM-22, 7800SM-23, 7800SM-24, 7800SM-27, 7800SM-30, 7800SM-32

8150SL

BE-9678

SBS87S, SBS87

1547

1150D

59S/31-1

8160-3, 8160-5, 8160-10

8166

8154-11

8171

8172

Fit&Go 3/3 Foam Inlay Mixed Striking/  
Cutting Toolset - 15 Pcs











**FF1A143**

45 x 445 x 543 mm 1 FF1A143

SQZ150003

FS-8

SQZ150003-SBL

























|  |   |
|--|---|
| MTB-5-25                                       |  |
| 481-400  |  |
| 3734-2, 3734-3, 3734-4, 3734-5, 3734-6, 3734-8 |  |
| 3735-5-120                                     |  |
| 3740-175                                       |  |
| 319  |  |
| 208  |  |
| 3625N-32                                       |  |

Fit&Go 3/3 Foam Inlay Screwdriver/File/Pliers Set - 20 Pcs



**FF1A145**

 38 x 445 x 543 mm  1 FF1A145

















|  |   |
|--|---|
| 2628 G-180   |    |
| 2430 G-160   |    |
| 8224   |   |
| 2101G-160  |    |
| 8045LVDE   |   |
| 808050   |   |
| 613-3-75   |   |
| 611-4-100, 611-5.5-100, 611-6.5-150, 611-8-150, 611-6.5-25 |   |
| 615-1-100, 615-2-125, 615-2-25                             |   |
| 1-100-08-1-2   |   |
| 1-160-08-1-2   |   |
| 1-170-08-2-2   |   |
| 1-210-08-1-2   |   |
| 1-230-08-1-2   |   |

Fit&Go 3/3 Foam Inlay 1/2" Socket/Pliers Set - 34 Pcs



**FF1A146**

 50 x 445 x 543 mm  1 FF1A146

















|   |  |
|---|--|
| 2628 G-180  |    |
| 2430 G-160  |    |
| 8224  |   |
| 2101G-160   |    |
| FS-8  |   |
| 7800SM-8, 7800SM-9, 7800SM-10, 7800SM-11, 7800SM-12, 7800SM-13, 7800SM-14, 7800SM-15, 7800SM-16, 7800SM-17, 7800SM-18, 7800SM-19, 7800SM-21, 7800SM-22, 7800SM-23, 7800SM-24, 7800SM-27, 7800SM-30, 7800SM-32 |   |
| 8150SL  |    |
| SBS87S, SBS87   |    |
| 8160-3, 8160-5, 8160-10   |    |
| 8166  |    |
| 8154-11   |    |
| 8171  |    |
| 8172  |    |

Fit&Go 3/3 Foam Inlay Cutting/Striking/Screwdriver Set - 16 Pcs



**FF1A147**

 40 x 445 x 543 mm  1 FF1A147













|  |  |
|--|--|
| 2951-250, 2951-180                       |    |
| SQZ150003                                |    |
| SQZ150003-SBL                            |    |
| B191.030.075, B191.040.100               |   |
| B190.055.100, B190.065.125, B190.080.150 |   |
| B195.050.025                             |   |
| B195.001.025                             |   |
| B192.001.100, B192.002.125               |   |
| 319                                      |    |
| 208                                      |    |
| 3625N-32                                 |    |

Fit&Go 3/3 Foam Inlay Cutters and Pliers Set - 12 Pcs



**FF1A15**

 40 x 445 x 543 mm  1 FF1A15

|                            |   |
|----------------------------|---|
| 2101GC-125IP, 2101GC-160IP |    |
| 2233D-240IP                |    |
| 2421GC-180IP               |    |
| 2427 GC-200IP              |   |
| 2430 GC-200 IP             |    |
| 2628 GC-160IP              |    |
| 2650                       |   |
| 2855, 2855 D               |   |
| 2951-180                   |    |
| 8224CIP                    |   |

Fit&Go 3/3 Foam Inlay 1/4" & 1/2" Socket Set and Wrenches - 94 Pcs



**FF1A153**

 335 x 445 x 543 mm  1 FF1A153

|       |   |
|-------|---|
| S87+7 |  |
|-------|---|





Fit&Go 3/3 Foam Inlay Mixed Striking/  
Cutting/ Pliers Set - 13 Pcs



**FF1A154**



37 x 445 x 543 mm

1 FF1A154

|                 |  |
|-----------------|--|
| 2171G-160       |  |
| 224 D           |  |
| 2470 G-160      |  |
| 317             |  |
| 3625W-28        |  |
| 3733-4          |  |
| 3734-3, 3734-6  |  |
| 3735-5-120      |  |
| 481-400         |  |
| KB18-01         |  |
| KSBG18-10DISPEN |  |
| 2678 G-180      |  |

Fit&Go 3/3 Foam Inlay Mixed Toolset - 18  
Pcs



**FF1A16**



40 x 445 x 543 mm

1 FF1A16

|             |  |
|-------------|--|
| KE18-01     |  |
| 1150-1/2H/P |  |
| MTB-3-16    |  |
| 1177-SCRIBE |  |
| 1544        |  |
| 2509        |  |
| 2535F2      |  |
| 2632        |  |
| 268         |  |
| 2744        |  |

|            |  |
|------------|--|
| 2820EF2    |  |
| 3525HB     |  |
| 5471 F-145 |  |
| 5515T      |  |
| 5515T-52   |  |
| 5516       |  |
| BFLA01     |  |
| SR300-E    |  |

Fit&Go 3/3 Foam Inlay 1/4" & 1/2" Socket  
Set, Spanners & Pliers - 50 pcs



**FF1A164**



40 x 445 x 543 mm

1 FF1A164

|   |  |
|---|--|
| 1RM-10, 1RM-11, 1RM-12, 1RM-13,<br>1RM-14, 1RM-15, 1RM-16, 1RM-17,<br>1RM-18, 1RM-19, 1RM-8 |  |
| 2058-BR   |  |
| S330  |  |
| 111M-24, 111M-21, 111M-27, 111M-32  |  |

Fit&Go 3/3 Foam Inlay 1/2" & 3/8" Socket  
Set & Bit Set - 177 pcs



**FF1A165**



40 x 445 x 543 mm

1 FF1A165

|            |  |
|------------|--|
| 59/S100B-T |  |
| BE5049     |  |
| S1214L     |  |
| S1612L     |  |
| SBS87      |  |
| 7402GPR-16 |  |

Fit&Go 3/3 Foam Inlay Pliers, L-Keys,  
Magnetic Dish and Picking - 23 pcs



**FF1A167**



45 x 445 x 543 mm

1 FF1A167

|                                       |  |
|---------------------------------------|--|
| 1178-SCRIBE                           |  |
| 1419-MD                               |  |
| 2101G-160IP                           |  |
| 2430 G-190HD                          |  |
| 2628 G-180IP                          |  |
| 2744                                  |  |
| 2953-250                              |  |
| 8224                                  |  |
| 9031                                  |  |
| BE-9770                               |  |
| BWSS12P317, BWSS12P319,<br>BWSS12P321 |  |
| CR B 02                               |  |
| 2530                                  |  |

Fit&Go 3/3 Foam Inlay Cutting Tools, Files  
& Impact Driver Set - 36 pcs





**FF1A168**



40 x 445 x 543 mm

1 FF1A168











|                    |  |
|--------------------|--|
| 1-100-08-2-2       |  |
| 1-210-08-2-2       |  |
| 1-230-08-2-2       |  |
| 2485               |  |
| 2487               |  |
| 319                |  |
| 268                |  |
| 3740-100, 3740-150 |  |
| 5515T              |  |
| 782-U              |  |

|                 |   |
|-----------------|---|
| 7865            |  |
| KB18-01         |  |
| KSBG18-10DISPEN |  |

Fit&Go 3/3 Foam Inlay Cutting Tools, Files & Impact Driver Set - 13 pcs 





|  |   |
|--|---|
| <b>FF1A169</b>   |    |
|  |   |
| 35 x 445 x 543 mm  | 1 FF1A169   |

|                        |   |
|------------------------|---|
| 2681                   |    |
| 3625W-28               |    |
| 3733-4                 |   |
| 3734-3, 3734-4, 3734-6 |  |
| 3735-5-120             |  |
| 481-400                |  |
| BB10                   |  |
| BE66152                |  |
| BT10P330               |  |
| MA321                  |  |
| MTB-3-16               |  |

Fit&Go 3/3 Foam Inlay Metric Double Head Offset Socket Spanners Set - 14 pcs 













|  |   |
|--|---|
| <b>FF1A170</b>   |    |
|  |   |
| 40 x 445 x 543 mm  | 1 FF1A170   |

|  |   |
|--|---|
| 28M-16, 28M-15, 28M-18, 28M-17, 28M-12, 28M-11, 28M-14, 28M-13, 28M-24, 28M-19, 28M-22, 28M-8, 28M-10, 28M-9 |  |
|--|---|

Fit&Go 3/3 Foam Inlay Striking/File Set - 24 Pcs 













|   |   |
|---|---|
| <b>FF1A18</b>   |   |
|  |   |
| 44 x 445 x 543 mm   | 1 FF1A18  |

|                  |  |
|------------------|--|
| 1-476-04-3-2     |     |
| 2633/S4          |    |
| 3734S/6          |    |
| 3736S/6          |    |
| 481-200, 481-500 |    |
| 782-U            |   |
| 3625N-32         |  |

Fit&Go 3/3 Foam Inlay Striking, Cutting & Pliers - 14 Pcs 













|   |   |
|---|---|
| <b>FF1A185</b>  |   |
|  |   |
| 40 x 445 x 543 mm   | 1 FF1A185   |

|                 |  |
|-----------------|--|
| 3734S/6-T       |  |
| 479-16          |  |
| 3625W-35        |  |
| KB18-01         |  |
| KSBG18-10DISPEN |  |
| 2101G-180IP     |  |
| 2470 G-200      |  |
| 2678 G-180      |  |
| 8224 IP         |  |
| 2530            |  |

Fit&Go 3/3 Foam Inlay Striking, Pliers, Cutting & Pick-Up Tool - 25 pcs 





|   |   |
|---|---|
| <b>FF1A189</b>  |    |
|  |   |
| 40 x 445 x 543 mm   | 1 FF1A189   |

|                 |   |
|-----------------|---|
| 3734S/6         |    |
| 479-16          |    |
| 3625W-35        |    |
| MTG-3-16        |    |
| KB18-01         |    |
| KSBG18-10DISPEN |    |
| 2101G-180IPD    |  |
| 2630GC-180IP    |  |
| 2470 G-200      |  |
| 8224 IP         |  |
| 2530            |  |

Fit&Go 3/3 Foam Inlay Adjustable/Combination/Double Open End Wrench Set - 33 Pcs 



|   |   |
|---|---|
| <b>FF1A19</b>   |    |
|  |   |
| 50 x 543 x 445 mm   | 1 FF1A19  |

|   |   |
|---|---|
| 111M-30, 111M-32, 111M-6, 111M-7, 111M-8, 111M-9, 111M-10, 111M-11, 111M-12, 111M-13, 111M-14, 111M-15, 111M-16, 111M-17, 111M-18, 111M-19, 111M-20, 111M-21, 111M-22, 111M-24, 111M-27 |  |
| 6M-6-7, 6M-8-9, 6M-10-11, 6M-12-13, 6M-14-15, 6M-16-17, 6M-18-19, 6M-20-22, 6M-21-23, 6M-24-27, 6M-30-32  |  |
| 92C   |  |





Fit&Go 3/3 Foam Inlay 1/2" & 1/4" Socket Set & Torque Wrench - 51 pcs



**FF1A194**

40 x 445 x 543 mm 1 FF1A194

|  |  |  |
|--|--|--|
| 6968   |  |  |
| 6700SM-14, 6700SM-13, 6700SM-12, 6700SM-11, 6700SM-10, 6700SM-9, 6700SM-8, 6700SM-7, 6700SM-6, 6700SM-5, 6700SM-4  |  |  |
| 6709M-3, 6709M-8, 6709M-6, 6709M-5, 6709M-4  |  |  |
| 6950SL   |  |  |
| 7800SM-24, 7800SM-23, 7800SM-22, 7800SM-13, 7800SM-12, 7800SM-11, 7800SM-10, 7800SM-9, 7800SM-8, 7800SM-21, 7800SM-19, 7800SM-18, 7800SM-17, 7800SM-16, 7800SM-15, 7800SM-14 |  |  |
| 7809M-8, 7809M-7, 7809M-10, 7809M-6, 7809M-5   |  |  |
| 7809TORX-T20, 7809TORX-T25, 7809TORX-T30, 7809TORX-T40   |  |  |
| 7455-200   |  |  |
| 8150SL   |  |  |
| 8168   |  |  |
| K6650-1/4-1P   |  |  |
| 6960W-2, 6960W-6   |  |  |
| 8160-10, 8160-5  |  |  |

Fit&Go 3/3 Foam Inlay Double Ring End/ Double Socket Head Ratchet Set - 18 Pcs



**FF1A20**

50 x 445 x 543 mm 1 FF1A20

|  |  |  |
|--|--|--|
| 2M-6-7, 2M-8-9, 2M-10-11, 2M-12-13, 2M-14-15, 2M-16-17, 2M-18-19, 2M-20-22, 2M-21-23, 2M-24-27, 2M-30-32 |  |  |
| 4040M-10-11, 4040M-12-13, 4040M-14-15, 4040M-16-17, 4040M-18-19, 4040M-21-23                             |  |  |
| 2953-250   |  |  |

Fit&Go 3/3 Foam Inlay Puller/Round Head Ratchet/Socket Set - 58 Pcs



**FF1A22**

50 x 445 x 543 mm 1 FF1A22

|   |  |  |
|---|--|--|
| 7800SM-10, 7800SM-12, 7800SM-13, 7800SM-14, 7800SM-16, 7800SM-17, 7800SM-18, 7800SM-19, 7800SM-21, 7800SM-22, 7800SM-23, 7800SM-24, 7800SM-27, 7800SM-30, 7800SM-32 |  |  |
| 7805SM-13, 7805SM-16, 7805SM-17, 7805SM-18, 7805SM-19, 7805SM-21, 7805SM-22, 7805SM-24, 7805SM-27, 7805SM-30, 7805SM-32   |  |  |
| 7809M-5, 7809M-6, 7809M-8, 7809M-10, 7809M-12, 7809M-14   |  |  |
| 8150SL  |  |  |
| 6700SM-4, 6700SM-4.5, 6700SM-5, 6700SM-5.5, 6700SM-6, 6700SM-7, 6700SM-8, 6700SM-9, 6700SM-10, 6700SM-11, 6700SM-12, 6700SM-13                                      |  |  |
| 6958  |  |  |
| 6954  |  |  |
| 6960, 6962  |  |  |
| 6966  |  |  |
| 6950SL  |  |  |
| 4532-A  |  |  |
| 8157-15   |  |  |
| 8154-11   |  |  |
| 8160-3, 8160-5  |  |  |
| 8166  |  |  |

Fit&Go 3/3 Foam Inlay Measuring Tape/ Striking/Pliers Set - 21 Pcs



**FF1A23**

40 x 445 x 543 mm 1 FF1A23

|  |  |
|--|--|
| 3735-4-120                                     |  |
| 3734-2, 3734-3, 3734-4, 3734-5, 3734-6, 3734-8 |  |
| 2630GC-180IP                                   |  |
| 2430 GC-200 IP                                 |  |
| 2427 GC-200IP                                  |  |
| 2900-180                                       |  |
| 2890-180                                       |  |
| 2990-180                                       |  |
| 2800-180                                       |  |
| 7224   |  |
| 2101GC-160IP                                   |  |
| 479-16   |  |
| 1547   |  |
| MTB-3-16                                       |  |
| SC127  |  |
| 3625N-32                                       |  |

Fit&Go 3/3 Foam Inlay Circlip Pliers & Spanners Set - 17 pcs



**FF1A230**

40 x 445 x 543 mm 1 FF1A230

|  |  |  |
|--|--|--|
| 1RM-9, 1RM-8, 1RM-11, 1RM-10, 1RM-13, 1RM-12, 1RM-15, 1RM-14, 1RM-17, 1RM-16, 1RM-19, 1RM-18 |  |  |
| 28-29/S4   |  |  |
| 8072 C   |  |  |

Fit&Go 3/3 Foam Inlay 3/4" Socket Set - 26 Pcs



**FF1A2301**



|                   |   |          |  |
|-------------------|---|----------|--|
|                   |   |          |  |
| 70 x 445 x 543 mm | 1 | FF1A2301 |  |

|   |  |  |
|---|--|--|
| 8900DM-19, 8900DM-22, 8900DM-23, 8900DM-24, 8900DM-25, 8900DM-26, 8900DM-27, 8900DM-28, 8900DM-29, 8900DM-30, 8900DM-32, 8900DM-33, 8900DM-34, 8900DM-36, 8900DM-41, 8900DM-46, 8900DM-50, 8900DM-55, 8900DM-60 |  |  |
| 8954  |  |  |
| 8954A   |  |  |
| 8958A   |  |  |
| 8961  |  |  |
| 8965  |  |  |
| 8966  |  |  |
| 8955N/B   |  |  |

Fit&Go 3/3 Laser Marked Foam Inlay with Automotive Plug Socketry - 31 pcs



**FF1A235**

|                   |         |   |         |
|-------------------|---------|---|---------|
|                   |         |   |         |
| 50 x 445 x 543 mm | 4.10 kg | 1 | FF1A235 |

|  |  |  |
|--|--|--|
| BE61110  |  |  |
| BE621702, BE621703, BE621701, BE621706, BE621707, BE621704, BE621705, BE621710, BE621711, BE621708, BE621709, BE621714, BE621715, BE621712, BE621713, BE621716, BE621717 |  |  |
| BE6810   |  |  |
| 2M-6-7, 2M-8-9, 2M-12-13, 2M-18-19, 2M-16-17, 2M-10-11, 2M-14-15, 2M-24-26, 2M-21-23, 2M-27-29, 2M-20-22, 2M-30-32   |  |  |

Fit&Go 3/3 Laser Marked Foam Inlay for Automotive Body Shop - 13 pcs



**FF1A236**

|                   |        |   |         |
|-------------------|--------|---|---------|
|                   |        |   |         |
| 55 x 445 x 543 mm | 9.5 kg | 1 | FF1A236 |

|              |  |  |
|--------------|--|--|
| 3-330-14-2-0 |  |  |
| 9-462-14-0-0 |  |  |
| 1467-250     |  |  |
| BBSH2F       |  |  |
| BBSH2CA      |  |  |
| BBSDW        |  |  |
| BBSDA        |  |  |
| BBSDT        |  |  |
| BBSDH        |  |  |
| BBSDC        |  |  |
| BBSDHR       |  |  |
| BBSS1        |  |  |
| 2485         |  |  |

Fit&Go 3/3 Foam Inlay Measuring Tape/Striking/Pliers Set - 19 Pcs



**FF1A24**

|                   |   |        |  |
|-------------------|---|--------|--|
|                   |   |        |  |
| 45 x 445 x 543 mm | 1 | FF1A24 |  |

|  |  |  |
|--|--|--|
| 3735-4-120                                     |  |  |
| 3734-2, 3734-3, 3734-4, 3734-5, 3734-6, 3734-8 |  |  |
| 2630GC-180IP                                   |  |  |

|                |  |  |
|----------------|--|--|
| 2430 GC-200 IP |  |  |
| 2900-180       |  |  |
| 2890-180       |  |  |
| 2990-180       |  |  |
| 2800-180       |  |  |
| 7224           |  |  |
| 2101GC-160IP   |  |  |
| 479-16         |  |  |
| 3625N-32       |  |  |
| MTB-3-16       |  |  |
| SC127          |  |  |

Fit&Go 3/3 Foam Inlay Socket and Round Head Ratchet Set - 50 Pcs



**FF1A25**

|                   |   |        |  |
|-------------------|---|--------|--|
|                   |   |        |  |
| 50 x 445 x 543 mm | 1 | FF1A25 |  |

|  |  |  |
|--|--|--|
| 7800SM-10, 7800SM-12, 7800SM-13, 7800SM-14, 7800SM-15, 7800SM-16, 7800SM-17, 7800SM-18, 7800SM-19, 7800SM-21, 7800SM-22, 7800SM-23, 7800SM-24, 7800SM-27, 7800SM-30, 7800SM-32 |  |  |
| 7805SM-13, 7805SM-16, 7805SM-17, 7805SM-18, 7805SM-19, 7805SM-21, 7805SM-22, 7805SM-24, 7805SM-27, 7805SM-30, 7805SM-32  |  |  |
| 8150SL   |  |  |
| 6700SM-4, 6700SM-4.5, 6700SM-5, 6700SM-5.5, 6700SM-6, 6700SM-7, 6700SM-8, 6700SM-9, 6700SM-10, 6700SM-11, 6700SM-12, 6700SM-13   |  |  |
| 6954   |  |  |
| 6960, 6962   |  |  |
| 6966   |  |  |
| 6950SL   |  |  |
| 2953-250   |  |  |
| 8166   |  |  |
| 8154-11  |  |  |
| 8160-3, 8160-5   |  |  |



Fit&Go 3/3 Foam Inlay 1/4" + 1/2" + 3/8" Socket and Pear/Round Head Ratchet Set - 83 Pcs



**FF1A2501**



|                   |            |
|-------------------|------------|
|                   |            |
| 50 x 445 x 543 mm | 1 FF1A2501 |

|   |  |  |
|---|--|--|
| 6700SM-4, 6700SM-5, 6700SM-5.5, 6700SM-6, 6700SM-7, 6700SM-8, 6700SM-9, 6700SM-10, 6700SM-11, 6700SM-12, 6700SM-13  |  |  |
| 6700TORX-E8, 6700TORX-E10   |  |  |
| 6709M-3, 6709M-4, 6709M-5, 6709M-6, 6709M-8   |  |  |
| 6709TORX-T8, 6709TORX-T10, 6709TORX-T15, 6709TORX-T20, 6709TORX-T25, 6709TORX-T27, 6709TORX-T30, 6709TORX-T40   |  |  |
| 6950SL  |  |  |
| 6954  |  |  |
| 6956  |  |  |
| 6962  |  |  |
| 6966  |  |  |
| 7400SM-8, 7400SM-9, 7400SM-10, 7400SM-11, 7400SM-12, 7400SM-13, 7400SM-14, 7400SM-15, 7400SM-16, 7400SM-17, 7400SM-18, 7400SM-19, 7400SM-20, 7400SM-21, 7400SM-22 |  |  |
| 7400TORX-E8, 7400TORX-E10, 7400TORX-E12, 7400TORX-E14   |  |  |
| 7750SL  |  |  |
| 7754  |  |  |
| 7762  |  |  |
| 7764  |  |  |
| 7765  |  |  |
| 7766  |  |  |
| 7768  |  |  |
| 7800SM-13, 7800SM-17, 7800SM-12, 7800SM-18, 7800SM-19, 7800SM-20, 7800SM-27, 7800SM-30, 7800SM-32, 7800SM-21, 7800SM-22, 7800SM-24                                |  |  |
| 7809M-12, 7809M-10  |  |  |
| 7809TORX-T20, 7809TORX-T25, 7809TORX-T40, 7809TORX-T50, 7809TORX-T55  |  |  |
| 8150SL  |  |  |
| 8164-1/2  |  |  |
| 8154-11   |  |  |
| 8160-10   |  |  |
| 8171  |  |  |
| 8166  |  |  |
| 8172  |  |  |

Fit&Go 3/3 Foam Inlay 1/2"-3/8" Socket Set - 101 Pcs



**FF1A2503**



|                   |            |
|-------------------|------------|
|                   |            |
| 55 x 445 x 543 mm | 1 FF1A2503 |

|   |  |  |
|---|--|--|
| 6700SM-4.5, 6700SM-4, 6700SM-5, 6700SM-5.5, 6700SM-6, 6700SM-7, 6700SM-8, 6700SM-9, 6700SM-10, 6700SM-11, 6700SM-12, 6700SM-13, 6700SM-14   |  |  |
| 7800SM-10, 7800SM-11, 7800SM-12, 7800SM-13, 7800SM-14, 7800SM-15, 7800SM-18, 7800SM-19, 7800SM-21, 7800SM-22, 7800SM-23, 7800SM-24, 7800SM-30, 7800SM-26, 7800SM-27, 7800SM-28, 7800SM-32, 7800SM-16, 7800SM-17, 7800SM-8, 7800SM-9 |  |  |
| BE-9678   |  |  |
| 7809M-10, 7809M-12, 7809M-14, 7809M-17, 7809M-19, 7809M-5, 7809M-7, 7809M-8, 7809M-9, 7809M-6   |  |  |
| 59S/31-1  |  |  |
| 7809M-10-140, 7809M-5-180, 7809M-6-140, 7809M-7-100, 7809M-8-120  |  |  |
| 808050  |  |  |
| 8155-1/2  |  |  |
| 6950  |  |  |
| 6954  |  |  |
| 6956  |  |  |
| 6960, 6962  |  |  |
| 6966  |  |  |
| 8154-11   |  |  |
| 8160-5, 8160-10   |  |  |
| 8166  |  |  |

Fit&Go 3/3 Foam Inlay Pliers and Wrench Set - 27 Pcs



**FF1A26**



|                   |          |
|-------------------|----------|
|                   |          |
| 50 x 445 x 543 mm | 1 FF1A26 |

|   |  |  |
|---|--|--|
| 111M-30, 111M-32, 111M-6, 111M-7, 111M-8, 111M-9, 111M-10, 111M-11, 111M-12, 111M-13, 111M-14, 111M-15, 111M-16, 111M-17, 111M-18, 111M-19, 111M-20, 111M-21, 111M-22, 111M-24, 111M-27 |  |  |
| 2630GC-180IP  |  |  |
| 2430 GC-200 IP  |  |  |
| 7224  |  |  |
| 2953-250  |  |  |
| 2101GC-160IP  |  |  |
| SC127   |  |  |

Fit&Go 3/3 Foam Inlay Socket and Striking Set - 48 Pcs



**FF1A28**



|                   |          |
|-------------------|----------|
|                   |          |
| 50 x 445 x 543 mm | 1 FF1A28 |

|  |  |  |
|--|--|--|
| 7800SM-18, 7800SM-19, 7800SM-21, 7800SM-22, 7800SM-23, 7800SM-24, 7800SM-27, 7800SM-30, 7800SM-32, 7800SM-10, 7800SM-12, 7800SM-13, 7800SM-14, 7800SM-15, 7800SM-16, 7800SM-17 |  |  |
| 8150SL   |  |  |
| 6700SM-4.5, 6700SM-5, 6700SM-5.5, 6700SM-6, 6700SM-7, 6700SM-8, 6700SM-9, 6700SM-10, 6700SM-11, 6700SM-12, 6700SM-13, 6700SM-4   |  |  |
| 6954   |  |  |
| 6960, 6962   |  |  |
| 6966   |  |  |
| 6950SL   |  |  |
| 3735-4-120   |  |  |
| 3734-2, 3734-3, 3734-4, 3734-5, 3734-6, 3734-8   |  |  |
| 479-16   |  |  |
| MTB-3-16   |  |  |
| 3625N-32   |  |  |
| 8154-11  |  |  |
| 8160-3, 8160-5   |  |  |
| 8166   |  |  |



Fit&Go 3/3 Foam Laser Marked Inlay Spanners, Pliers & Sockets - 45 pcs



**FF1A29NB**

|                   |         |   |          |
|-------------------|---------|---|----------|
|                   |         |   |          |
| 50 x 445 x 543 mm | 6.26 kg | 1 | FF1A29NB |

111M-6, 111M-7, 111M-8, 111M-9, 111M-13, 111M-12, 111M-11, 111M-10, 111M-24, 111M-22, 111M-17, 111M-16, 111M-15, 111M-14, 111M-21, 111M-19, 111M-18

8071 IP

2470 G-160

2971G-250

2171G-160

8150SL

SBS83-10, SBS83-5

SBS87S

SBS85

SP16SLH

7800SM-27, 7800SM-22, 7800SM-23, 7800SM-24, 7800SM-18, 7800SM-19, 7800SM-20, 7800SM-21, 7800SM-14, 7800SM-15, 7800SM-16, 7800SM-17, 7800SM-10, 7800SM-11, 7800SM-12, 7800SM-13, 7800SM-30, 7800SM-22

Fit&Go 3/3 Foam Inlay Combination Wrench Set - 21 Pcs



**FF1A3001**

|                   |   |          |
|-------------------|---|----------|
|                   |   |          |
| 40 x 445 x 543 mm | 1 | FF1A3001 |

111M-32, 111M-30, 111M-24, 111M-22, 111M-27, 111M-17, 111M-16, 111M-15, 111M-14, 111M-21, 111M-20, 111M-19, 111M-18, 111M-9, 111M-8, 111M-7, 111M-6, 111M-13, 111M-12, 111M-11, 111M-10

Fit&Go 3/3 Foam Inlay Combination Ratcheting Wrench Set - 7 Pcs



**FF1A3002**

|                   |   |          |
|-------------------|---|----------|
|                   |   |          |
| 35 x 445 x 543 mm | 1 | FF1A3002 |

1RM-24, 1RM-22, 1RM-21, 1RM-19, 1RM-32, 1RM-30, 1RM-27

Fit&Go 3/3 Foam Inlay Combination Offset Wrench Set - 28 Pcs



**FF1A3003**

|                   |   |          |
|-------------------|---|----------|
|                   |   |          |
| 40 x 445 x 543 mm | 1 | FF1A3003 |

1952M-27, 1952M-21, 1952M-20, 1952M-19, 1952M-18, 1952M-24, 1952M-22, 1952M-13, 1952M-12, 1952M-11, 1952M-10, 1952M-17, 1952M-16, 1952M-15, 1952M-14, 1952M-9, 1952M-8, 1952M-7, 1952M-6

BE-9778

Fit&Go 3/3 Foam Inlay Standard Combination and Ratcheting Wrench Set - 30 Pcs



**FF1A3004**

|                   |   |          |
|-------------------|---|----------|
|                   |   |          |
| 48 x 445 x 543 mm | 1 | FF1A3004 |

111M-24, 111M-22, 111M-17, 111M-16, 111M-15, 111M-14, 111M-21, 111M-20, 111M-19, 111M-18, 111M-9, 111M-8, 111M-7, 111M-6, 111M-13, 111M-12, 111M-11, 111M-10

1RM-19, 1RM-10, 1RM-9, 1RM-8, 1RM-14, 1RM-13, 1RM-12, 1RM-11, 1RM-18, 1RM-17, 1RM-16, 1RM-15

Fit&Go 3/3 Foam Inlay Offset Combination and Ratcheting Wrench Set - 28 Pcs



**FF1A3005**

|                   |   |          |
|-------------------|---|----------|
|                   |   |          |
| 38 x 445 x 543 mm | 1 | FF1A3005 |

1952M-19, 1952M-18, 1952M-22, 1952M-13, 1952M-12, 1952M-11, 1952M-10, 1952M-17, 1952M-16, 1952M-15, 1952M-14, 1952M-9, 1952M-8, 1952M-7, 1952M-6

1RM-6, 1RM-10, 1RM-9, 1RM-8, 1RM-7, 1RM-24, 1RM-22, 1RM-19, 1RM-14, 1RM-13, 1RM-12, 1RM-11, 1RM-17

Fit&Go 3/3 Foam Laser Marked Inlay ERGO™ Screwdrivers, Ratchet, Sockets & Bit Set - 22 pcs



**FF1A30NB**

|                   |        |   |          |
|-------------------|--------|---|----------|
|                   |        |   |          |
| 35 x 445 x 543 mm | 2.8 kg | 1 | FF1A30NB |

BE-8020, BE-8030, BE-8040

BE-8150, BE-8155

BE-8160

BE-8611, BE-8621

BE-8811, BE-8821

BE-8910, BE-8915, BE-8920, BE-8925, BE-8930

808050S

808050

6972H

K6650-1/4-1P

6950SL

59S/31-1

SBS64

SB6963

SBS60-4, SBS60-11, SBS60-12, SBS60-13, SBS60-7, SBS60-8, SBS60-9, SBS60-10, SBS60-4.5, SBS60-5, SBS60-5.5, SBS60-6



Fit&Go 3/3 Foam Laser Marked Inlay Striking, Cutting Tools, Files & L-Keys - 28 pcs



**FF1A31NB**

45 x 445 x 543 mm 2.69 kg 1 FF1A31NB

|                 |  |
|-----------------|--|
| 317             |  |
| 1-100-08-1-2    |  |
| 1-210-08-1-2    |  |
| 1-230-08-1-2    |  |
| MTB-3-16        |  |
| 3625W-35        |  |
| 481-300         |  |
| 782-U           |  |
| BE-9770         |  |
| KG09-01         |  |
| KSBG09-10DISPEN |  |

Fit&Go 3/3 Foam Inlay Striking and File Set - 24 Pcs



**FF1A35**

42 x 445 x 543 mm 1 FF1A35

|   |  |
|---|--|
| 317   |  |
| 1-100-08-1-2  |  |
| 1-210-08-1-2  |  |
| 1-230-08-1-2  |  |
| MTB-3-16  |  |
| 3625W-35  |  |
| 481-300   |  |
| 782-U   |  |
| BE-9770   |  |
| KG09-01   |  |
| 4040M-8-9, 4040M-10-11, 4040M-12-13, 4040M-14-15, 4040M-16-17 |  |

Fit&Go 3/3 Foam Inlay Screwdriver/Bit/Socket Set - 89 Pcs



**FF1A36**

50 x 445 x 543 mm 1 FF1A36

|  |  |
|--|--|
| 4040M-8-9, 4040M-10-11, 4040M-12-13, 4040M-14-15, 4040M-16-17  |  |
| 808050S  |  |
| 808050   |  |
| 6972H  |  |
| K6650-1/4-1P, 59S/H8   |  |
| 6950SL   |  |
| 59S/31-1   |  |
| 59S/H2, 59S/H3, 59S/H4, 59S/H5, 59S/H6   |  |
| 8030-2P, 8040-2P, 8242-2P, 8252-2P   |  |
| 8610-2P, 8620-2P, 8630-2P  |  |
| 8810-2P, 8820-2P, 8830-2P  |  |
| 8910-2P, 8915-2P, 8925-2P, 8930-2P, 8940-2P  |  |
| BE-8575  |  |
| SBS60-11, SBS60-12, SBS60-13, SBS60-4, SBS60-4.5, SBS60-5, SBS60-5.5, SBS60-6, SBS60-7, SBS60-8, SBS60-9, SBS60-10 |  |
| SB6963   |  |
| SBS64  |  |

Fit&Go 3/3 Foam Inlay Socket and Wrench Set - 46 Pcs



**FF1A37**

35 x 445 x 543 mm 1 FF1A37

|   |  |
|---|--|
| 111M-6, 111M-7, 111M-8, 111M-9, 111M-10, 111M-11, 111M-12, 111M-13, 111M-14, 111M-15, 111M-16, 111M-17, 111M-18, 111M-19, 111M-21, 111M-22, 111M-24 |  |
| 8071 IP   |  |
| 2101G-160   |  |
| 2430 G-160  |  |
| 8224  |  |
| S240NB-NR   |  |
| 8150SL  |  |

Fit&Go 3/3 Foam Inlay Socket and Wrench Set - 54 Pcs



**FF1A39**

45 x 445 x 543 mm 1 FF1A39

|         |  |
|---------|--|
| S410    |  |
| S1612L  |  |
| 8071 IP |  |

Fit&Go 3/3 Foam Inlay Pliers Set - 12 Pcs



**FF1A4001**

38 x 445 x 543 mm 1 FF1A4001

|             |  |
|-------------|--|
| 1520 D      |  |
| 2101G-160IP |  |
| 21HDG-200IP |  |
| 2223 G-150  |  |



|                             |  |
|-----------------------------|--|
| 2421 G-140IP, 2421 G-180 IP |  |
| 2427 G-200 IP               |  |
| 2628 G-180IP                |  |
| 2681                        |  |
| 2951-140, 2951-300          |  |
| 8224 IP                     |  |

Fit&Go 3/3 Foam Inlay Pliers Set - 11 Pcs



**FF1A4002**

42 x 445 x 543 mm 1 FF1A4002

|               |  |
|---------------|--|
| 2101G-160IP   |  |
| 2430 G-200 IP |  |
| 2465D-200     |  |
| 2628 G-160IP  |  |
| 2744          |  |
| 2951-140      |  |
| 2952-165      |  |
| 1520 G        |  |
| 527 D-160     |  |
| 7224          |  |
| 5515FL        |  |

Fit&Go 3/3 Foam Inlay Circlip Pliers Set - 12 Pcs



**FF1A4003**

35 x 445 x 543 mm 1 FF1A4003

|                              |  |
|------------------------------|--|
| 2800-150, 2800-180, 2800-225 |  |
| 2890-140, 2890-180, 2890-210 |  |
| 2900-150, 2900-180, 2900-215 |  |
| 2990-140, 2990-180, 2990-200 |  |

Fit&Go 3/3 Foam Inlay Striking and Saw Set - 9 Pcs



**FF1A41**

42 x 445 x 543 mm 1 FF1A41

|            |  |
|------------|--|
| 2171G-160  |  |
| 2470 G-160 |  |
| 2971G-250  |  |
| MTB-3-16   |  |
| WR2-12     |  |
| 3625W-35   |  |
| 481-300    |  |
| 218        |  |
| 306        |  |

Fit&Go 3/3 Foam Inlay Spanners Set - 31 pcs



**FF1A48**

44 x 543 x 445 mm 1 FF1A48

|   |  |
|---|--|
| 1RM-6, 1RM-7, 1RM-8, 1RM-9, 1RM-10, 1RM-11, 1RM-12, 1RM-13, 1RM-14, 1RM-17, 1RM-19, 1RM-22, 1RM-24, 1RM-27  |  |
| 111M-6, 111M-7, 111M-8, 111M-9, 111M-10, 111M-11, 111M-12, 111M-13, 111M-14, 111M-15, 111M-16, 111M-17, 111M-18, 111M-19, 111M-20, 111M-21, 111M-22, 111M-24, 111M-27 |  |

Fit&Go 3/3 Foam Inlay Pliers/Wrench Set - 13 Pcs



**FF1A50**

45 x 445 x 543 mm 1 FF1A50

|                           |  |
|---------------------------|--|
| 8223 IP, 8224 IP, 8225 IP |  |
| 1420                      |  |
| 2430 G-160 IP             |  |
| 2427 G-160 IP             |  |
| 8069                      |  |
| 9070                      |  |
| 9031                      |  |
| 2101G-160IP               |  |
| 21HDG-180IP               |  |

Fit&Go 3/3 Foam Inlay Wrench/Drift Punch Set - 27 Pcs



**FF1A5002**

50 x 445 x 543 mm 1 FF1A5002

|   |  |
|---|--|
| 111M-30, 111M-32, 111M-6, 111M-7, 111M-8, 111M-9, 111M-10, 111M-11, 111M-12, 111M-13, 111M-14, 111M-15, 111M-16, 111M-17, 111M-18, 111M-19, 111M-20, 111M-21, 111M-22, 111M-24, 111M-27 |  |
| 3734S/6   |  |



Fit&Go 3/3 Foam Inlay 1/4" + 3/8" Socket and Combination Wrench Set - 91 Pcs



**FF1A5003**



45 x 445 x 543 mm 1 FF1A5003

|  |  |  |
|--|--|--|
| 111M-13, 111M-12, 111M-10, 111M-8, 111M-19, 111M-17, 111M-15   |  |  |
| 6700SM-5.5, 6700SM-5, 6700SM-14, 6700SM-13, 6700SM-12, 6700SM-11, 6700SM-10, 6700SM-9, 6700SM-8, 6700SM-7, 6700SM-6                                    |  |  |
| 6700TORX-E5, 6700TORX-E4, 6700TORX-E10, 6700TORX-E8, 6700TORX-E7, 6700TORX-E6  |  |  |
| 6709TORX-T27, 6709TORX-T25, 6709TORX-T20, 6709TORX-T15, 6709TORX-T10, 6709TORX-T9, 6709TORX-T8, 6709TORX-T40, 6709TORX-T30                             |  |  |
| 6950   |  |  |
| 6961, 6962   |  |  |
| 6966   |  |  |
| 7400SM-13, 7400SM-12, 7400SM-11, 7400SM-10, 7400SM-9, 7400SM-8, 7400SM-21, 7400SM-19, 7400SM-18, 7400SM-17, 7400SM-16, 7400SM-15, 7400SM-14, 7400SM-22 |  |  |
| 7400TORX-E18, 7400TORX-E16, 7400TORX-E14, 7400TORX-E12, 7400TORX-E11, 7400TORX-E10, 7400TORX-E8  |  |  |
| 7409TORX-T30, 7409TORX-T27, 7409TORX-T25, 7409TORX-T50, 7409TORX-T45, 7409TORX-T40   |  |  |
| 7750   |  |  |
| 7760, 7761, 7762   |  |  |
| 7764   |  |  |
| 7765   |  |  |
| 7766   |  |  |
| A6800DM-8, A6800DM-7, A6800DM-6, A6800DM-14, A6800DM-13, A6800DM-12, A6800DM-11, A6800DM-10, A6800DM-9   |  |  |
| A7402DM-19, A7402DM-18, A7402DM-17, A7402DM-16, A7402DM-15, A7402DM-14, A7402DM-13, A7402DM-12, A7402DM-11, A7402DM-10                                 |  |  |
| 8157-15  |  |  |

Fit&Go 3/3 Foam Inlay Wrench/Socket Set - 38 Pcs



**FF1A5004**



55 x 445 x 543 mm 1 FF1A5004

|  |  |  |
|--|--|--|
| 1RM-19, 1RM-13, 1RM-12, 1RM-11, 1RM-10, 1RM-9, 1RM-8, 1RM-27, 1RM-7, 1RM-24, 1RM-6, 1RM-22, 1RM-17 |  |  |
| 6700SM-13, 6700SM-12, 6700SM-11, 6700SM-10, 6700SM-9, 6700SM-8, 6700SM-7, 6700SM-6                 |  |  |
| 6950   |  |  |
| 6960   |  |  |
| 6966   |  |  |
| 7800SM-19, 7800SM-17, 7800SM-32, 7800SM-30, 7800SM-13, 7800SM-27, 7800SM-24, 7800SM-22             |  |  |
| 8155-1/2   |  |  |
| SBS86  |  |  |
| 6954   |  |  |
| 8160-5   |  |  |
| 8166   |  |  |

Fit&Go 3/3 Foam Inlay Standard Combination Wrench/Socket Set - 83 Pcs



**FF1A5005**



50 x 445 x 543 mm 1 FF1A5005

|   |  |  |
|---|--|--|
| 111M-17, 111M-15, 111M-13, 111M-19, 111M-8  |  |  |
| 6700SM-8, 6700SM-7, 6700SM-6, 6700SM-12, 6700SM-11, 6700SM-10, 6700SM-9, 6700SM-14, 6700SM-13, 6700SM-5, 6700SM-4 |  |  |
| 6709M-5, 6709M-4, 6709M-8, 6709M-6, 6709M-3   |  |  |

|  |  |
|--|--|
| 6950SL   |  |
| 6962   |  |
| 6968   |  |
| 7400SM-8, 7400SM-7, 7400SM-6, 7400SM-12, 7400SM-11, 7400SM-10, 7400SM-9, 7400SM-16, 7400SM-15, 7400SM-14, 7400SM-13, 7400SM-18, 7400SM-17  |  |
| 7750SL   |  |
| 7760-W   |  |
| 7761   |  |
| 7768   |  |
| 7800SM-11, 7800SM-10, 7800SM-15, 7800SM-14, 7800SM-13, 7800SM-12, 7800SM-19, 7800SM-18, 7800SM-17, 7800SM-16, 7800SM-22, 7800SM-21, 7800SM-27, 7800SM-24, 7800SM-32, 7800SM-30, 7800SM-8, 7800SM-9 |  |
| 7809M-17, 7809M-14, 7809M-12, 7809M-10, 7809M-5, 7809M-6, 7809M-7, 7809M-8   |  |
| 7809TORX-T40, 7809TORX-T30, 7809TORX-T25, 7809TORX-T20, 7809TORX-T45   |  |
| 8150SL   |  |
| A6709M-6, A6709M-5, A6709M-4, A6709M-3, A6709M-2.5   |  |
| K6650-1/4-1P   |  |
| 6960W-2, 6960W-6   |  |
| 8160-5, 8160-10  |  |
| 8166   |  |

Fit&Go 3/3 Foam Inlay Files and Wrench Set - 27 Pcs



**FF1A5006**



54 x 445 x 543 mm 1 FF1A5006

|  |  |  |
|--|--|--|
| 1-100-08-2-2   |  |  |
| 1-210-08-2-2   |  |  |
| 1-230-06-2-2, 1-230-10-2-2   |  |  |
| 111M-7, 111M-8, 111M-9, 111M-10, 111M-11, 111M-12, 111M-13, 111M-14, 111M-15, 111M-16, 111M-17, 111M-18, 111M-19, 111M-21, 111M-22 |  |  |
| 1320RM-6-7, 1320RM-8-9, 1320RM-10-11, 1320RM-12-13, 1320RM-14-15, 1320RM-16-17, 1320RM-18-19, 1320RM-22-24                         |  |  |

Fit&Go 3/3 Foam Inlay Socket/Striking Toolset - 60 Pcs



**FF1A5007**

50 x 445 x 543 mm 1 FF1A5007

|  |  |
|--|--|
| K6650-1/4-1P   |  |
| 3734-2, 3734-3, 3734-4, 3734-5, 3734-6, 3734-8   |  |
| 481-400  |  |
| 6700SM-11, 6700SM-12, 6700SM-13, 6700SM-14, 6700SM-10, 6700SM-5, 6700SM-6, 6700SM-7, 6700SM-8, 6700SM-9, 6700SM-4  |  |
| 6709F-8, 6709F-5.5   |  |
| 6709M-3, 6709M-4, 6709M-5, 6709M-6   |  |
| 6709PH-1, 6709PH-2   |  |
| 6950SL   |  |
| 6954   |  |
| 6960, 6962   |  |
| 6966   |  |
| 7800SM-18, 7800SM-19, 7800SM-10, 7800SM-11, 7800SM-12, 7800SM-13, 7800SM-14, 7800SM-15, 7800SM-16, 7800SM-17, 7800SM-21, 7800SM-22, 7800SM-23, 7800SM-24, 7800SM-25, 7800SM-26, 7800SM-27, 7800SM-28, 7800SM-30, 7800SM-32 |  |
| 8072 IP  |  |
| B145.006.100   |  |
| 8150SL   |  |
| 8224 IP  |  |
| 8154-11  |  |
| 8160-5, 8160-10  |  |
| 8166   |  |

Fit&Go 3/3 Foam Inlay Adjustable Wrench/Striking/Measuring Toolset - 24 Pcs



**FF1A5008**

50 x 445 x 543 mm 1 FF1A5008

|              |  |
|--------------|--|
| 1-100-08-2-2 |  |
| 1-160-08-2-2 |  |

|  |  |
|--|--|
| 1-170-08-2-2                                   |  |
| 1-210-08-2-2                                   |  |
| 1-230-08-2-2                                   |  |
| 1150D  |  |
| 1450D-ISO                                      |  |
| 1547   |  |
| 3625N-40                                       |  |
| 3734-2, 3734-3, 3734-4, 3734-5, 3734-6, 3734-8 |  |
| 3735-4-120, 3735-5-150                         |  |
| 3740-125, 3740-150                             |  |
| 38-20  |  |
| 5515T  |  |
| 9029, 9031                                     |  |
| MTB-3-16                                       |  |

Fit&Go 3/3 Foam Inlay Insulated Wrench/Pliers/Screwdriver Set - 17 Pcs



**FF1A5009**

38 x 445 x 543 mm 1 FF1A5009

|  |  |
|--|--|
| 2101S-160  |  |
| 2223 S-150                                       |  |
| 2250V-170  |  |
| 2430 S-200                                       |  |
| 2628 S-180                                       |  |
| 8072V  |  |
| BE-8220S, BE-8040S, BE-8050S, BE-8255S, BE-8065S |  |
| BE-8340  |  |
| BE-8601  |  |
| BE-8610S, BE-8620S                               |  |
| BE-8810S, BE-8820S                               |  |

Fit&Go 3/3 Foam Inlay Adjustable Wrench/Striking/File/Pliers Set - 22 Pcs



**FF1A5010**

35 x 445 x 543 mm 1 FF1A5010

|  |  |
|--|--|
| 1-100-08-1-2                                   |  |
| 1-160-08-1-2                                   |  |
| 1-170-08-2-2                                   |  |
| 1-210-08-1-2                                   |  |
| 1-230-08-1-2                                   |  |
| 2101G-180IP                                    |  |
| 2427 G-200 IP                                  |  |
| 2430 G-200 IP                                  |  |
| 2628 G-180IP                                   |  |
| 3733-2, 3733-4, 3733-6                         |  |
| 3734-2, 3734-3, 3734-4, 3734-5, 3734-6, 3734-8 |  |
| 3735-4-120                                     |  |
| 481-300  |  |
| 8069 IP  |  |
| 9031   |  |

Fit&Go 3/3 Foam Inlay Pliers/Striking/File/Screwdriver Set - 27 Pcs



**FF1A5011**

44 x 445 x 543 mm 1 FF1A5011

|  |  |
|--|--|
| 1-476-04-3-2                                   |  |
| 1178-SCRIBE                                    |  |
| 1547   |  |
| 2101G-160IP                                    |  |
| 2427 G-160 IP                                  |  |
| 2430 G-160 IP                                  |  |
| 3734-2, 3734-3, 3734-4, 3734-5, 3734-6, 3734-8 |  |
| 3735-5-120                                     |  |
| 481-500  |  |
| BE-8020L, BE-8040                              |  |
| BE-8150, BE-8255, BE-8256                      |  |
| BE-8610, BE-8620                               |  |
| MTB-3-16                                       |  |





Fit&Go 3/3 Foam Inlay Striking and Measuring Toolset - 13 Pcs



**FF1A5012**



48 x 445 x 543 mm



1 FF1A5012



|  |  |
|--|--|
| 141                                    |  |
| 3734-2, 3734-3, 3734-4, 3734-5, 3734-6 |  |
| 479-08                                 |  |
| 481-1000, 481-300                      |  |
| 782-U                                  |  |
| MTS-5-25                               |  |
| SQZ150003                              |  |
| 319                                    |  |

Fit&Go 3/3 Foam Inlay Socket/Combination Wrench Set - 41 Pcs



**FF1A5013**



50 x 445 x 543 mm



1 FF1A5013



|  |  |
|--|--|
| 111M-6, 111M-7, 111M-8, 111M-9, 111M-12, 111M-13, 111M-17, 111M-10, 111M-11, 111M-19, 111M-20, 111M-22, 111M-24, 111M-27, 111M-32, 111M-30 |  |
| 6700SM-6, 6700SM-7, 6700SM-8, 6700SM-9, 6700SM-10, 6700SM-11, 6700SM-12, 6700SM-13, 6700SM-14  |  |
| 6950   |  |
| 6960   |  |
| 6966   |  |
| 7800SM-19, 7800SM-17, 7800SM-13, 7800SM-22, 7800SM-27, 7800SM-24, 7800SM-30, 7800SM-32   |  |
| 8155-1/2   |  |
| SBS86  |  |
| 6954   |  |
| 8160-5   |  |
| 8166   |  |

Fit&Go 3/3 Foam Inlay Screwdriver/Hacksaw Set - 17 Pcs



**FF1A5015**



45 x 445 x 543 mm



1 FF1A5015



|                           |  |
|---------------------------|--|
| 319                       |  |
| 268                       |  |
| 208                       |  |
| 2509                      |  |
| 2444                      |  |
| 2744                      |  |
| 5515T                     |  |
| BE-8020L, BE-8040         |  |
| BE-8150, BE-8255, BE-8256 |  |
| BE-8340                   |  |
| BE-8601                   |  |
| BE-8610, BE-8620          |  |
| MTB-5-25                  |  |

Fit&Go 3/3 Foam Inlay Screwdriver/Wrench Set - 16 Pcs



**FF1A5017**



35 x 445 x 543 mm



1 FF1A5017



|  |  |
|--|--|
| 3734-2, 3734-3, 3734-4, 3734-5, 3734-6, 3734-8       |  |
| 3735-5-120   |  |
| 3740-175   |  |
| 481-400  |  |
| 111M-21, 111M-22, 111M-24, 111M-27, 111M-32, 111M-30 |  |
| 3625N-32   |  |

Fit&Go 3/3 Foam Inlay Wrench/Pliers/Socket Set - 47 Pcs



**FF1A5019**



52 x 445 x 543 mm



1 FF1A5019



|   |  |
|---|--|
| 111M-17, 111M-18, 111M-19, 111M-20, 111M-6, 111M-7, 111M-8, 111M-13, 111M-14, 111M-15, 111M-16, 111M-9, 111M-10, 111M-11, 111M-12   |  |
| 2101G-160IP   |  |
| 2430 G-160 IP   |  |
| 2628 G-180IP  |  |
| 7800DM-12, 7800DM-13, 7800DM-14, 7800DM-15, 7800DM-10, 7800DM-11, 7800DM-20, 7800DM-21, 7800DM-22, 7800DM-23, 7800DM-16, 7800DM-17, 7800DM-18, 7800DM-19, 7800DM-28, 7800DM-30, 7800DM-32, 7800DM-24, 7800DM-25, 7800DM-26, 7800DM-27, 7800DM-8, 7800DM-9 |  |
| 8155-1/2  |  |
| 8224 IP   |  |
| 8154-11   |  |
| 8160-5, 8160-10   |  |
| 8166  |  |

Fit&Go 3/3 Foam Inlay Screwdriver/Cutting Tool Set - 17 Pcs



**FF1A5021**



45 x 445 x 543 mm



1 FF1A5021



|                           |  |  |
|---------------------------|--|--|
| BE-8020L, BE-8040         |  |  |
| BE-8150, BE-8255, BE-8256 |  |  |
| BE-8340                   |  |  |
| BE-8601                   |  |  |
| BE-8610, BE-8620          |  |  |
| 319                       |  |  |
| MTB-5-25                  |  |  |
| 2444                      |  |  |
| 268                       |  |  |
| 5515T                     |  |  |
| 2509                      |  |  |
| 2744                      |  |  |
| 208                       |  |  |

Fit&Go 3/3 Foam Inlay Pliers/Wrench/  
Socket Set - 26 Pcs



**FF1A5022**

50 x 445 x 543 mm 1 FF1A5022

|   |  |  |
|---|--|--|
| 6700SM-4.5, 6700SM-5, 6700SM-5.5, 6700SM-6, 6700SM-7, 6700SM-8, 6700SM-9, 6700SM-10, 6700SM-11, 6700SM-12, 6700SM-13, 6700SM-14, 6700SM-4 |  |  |
| 6950  |  |  |
| 6954  |  |  |
| 6956  |  |  |
| 6960, 6962  |  |  |
| 6966  |  |  |
| 8070  |  |  |
| 9031  |  |  |
| 9072 P  |  |  |
| 141   |  |  |
| 2101G-160IP   |  |  |
| 2430 G-160 IP   |  |  |
| 2628 G-180IP  |  |  |
| 8224 IP   |  |  |

Fit&Go 3/3 Foam Inlay Screwdriver/Cutting  
Tool Set - 16 Pcs



**FF1A5023**

45 x 445 x 543 mm 1 FF1A5023

|                           |  |  |
|---------------------------|--|--|
| 208                       |  |  |
| 2444                      |  |  |
| 2509                      |  |  |
| 268                       |  |  |
| 2744                      |  |  |
| 319                       |  |  |
| 5515T                     |  |  |
| BE-8020L, BE-8040         |  |  |
| BE-8150, BE-8255, BE-8256 |  |  |
| BE-8340                   |  |  |
| BE-8601                   |  |  |
| BE-8610, BE-8620          |  |  |

Fit&Go 3/3 Foam Inlay Wrench and Pliers  
Set - 28 Pcs



**FF1A5024**

45 x 445 x 543 mm 1 FF1A5024

|  |  |  |
|--|--|--|
| 111M-12, 111M-13, 111M-6, 111M-7, 111M-8, 111M-9, 111M-10, 111M-11                           |  |  |
| 1RM-17, 1RM-18, 1RM-19, 1RM-8, 1RM-9, 1RM-10, 1RM-11, 1RM-12, 1RM-13, 1RM-14, 1RM-15, 1RM-16 |  |  |
| 2101G-160IP  |  |  |
| 2430 G-160 IP  |  |  |
| 141  |  |  |
| 2628 G-180IP   |  |  |
| 9031   |  |  |

9072 P

8070

8224 IP



Fit&Go 3/3 Foam Inlay Socket/Wrench  
Set - 36 Pcs



**FF1A5027**

44 x 445 x 543 mm 1 FF1A5027

|   |  |  |
|---|--|--|
| 2M-20-22, 2M-21-23, 2M-24-27, 2M-25-28, 2M-30-32  |  |  |
| 4040M-10-11, 4040M-12-13, 4040M-14-15, 4040M-16-17, 4040M-18-19, 4040M-20-22, 4040M-21-23, 4040M-8-9  |  |  |
| 7400SM-6, 7400SM-7, 7400SM-12, 7400SM-13, 7400SM-14, 7400SM-15, 7400SM-8, 7400SM-9, 7400SM-10, 7400SM-11, 7400SM-20, 7400SM-21, 7400SM-22, 7400SM-16, 7400SM-17, 7400SM-18, 7400SM-19 |  |  |
| 7754  |  |  |
| 7755-3/8  |  |  |
| 7760, 7761, 7762  |  |  |
| 7766  |  |  |

Fit&Go 3/3 Foam Inlay Socket/Wrench  
Set - 32 Pcs



**FF1A5028**

45 x 445 x 543 mm 1 FF1A5028

|   |  |  |
|---|--|--|
| 111M-6, 111M-7, 111M-8, 111M-9, 111M-10, 111M-11, 111M-14, 111M-15, 111M-16, 111M-17, 111M-18, 111M-19, 111M-20, 111M-12, 111M-13 |  |  |
| 1419-MD   |  |  |
| BE-8906, BE-8907, BE-8908, BE-8909, BE-8910, BE-8915, BE-8920, BE-8925, BE-8927, BE-8930, BE-8940, BE-8945                        |  |  |
| 7805DM-12, 7805DM-13, 7805DM-17, 7805DM-10, 7805DM-19   |  |  |





Fit&Go 3/3 Foam Inlay Pliers/Wrench Set - 29 Pcs



**FF1A5029**

|                   |   |          |
|-------------------|---|----------|
|                   |   |          |
| 40 x 445 x 543 mm | 1 | FF1A5029 |

|  |  |
|--|--|
| 2628 G-180IP   |  |
| 2101G-160IP  |  |
| 2430 G-160 IP  |  |
| 8224 IP  |  |
| BBR201P6   |  |
| BE5103   |  |
| 2M-10-11, 2M-12-13, 2M-14-15, 2M-16-17, 2M-18-19, 2M-6-7, 2M-8-9                   |  |
| 7809TORX-T50, 7809TORX-T55, 7809TORX-T25, 7809TORX-T30, 7809TORX-T40, 7809TORX-T45 |  |

Fit&Go 3/3 Foam Inlay Screw/Socket Driver Set - 62 Pcs



**FF1A5031**

|                   |   |          |
|-------------------|---|----------|
|                   |   |          |
| 48 x 445 x 543 mm | 1 | FF1A5031 |

|   |  |
|---|--|
| 1419-MD   |  |
| 7809M-10, 7809M-12, 7809M-14, 7809M-17, 7809M-19, 7809M-7, 7809M-8, 7809M-5, 7809M-9, 7809M-6 |  |
| BE-9678   |  |
| 7809M-10-140, 7809M-5-180, 7809M-6-140, 7809M-7-100, 7809M-8-120                              |  |
| 59S/31-1  |  |
| 808050  |  |
| 7805DM-12, 7805DM-13, 7805DM-17, 7805DM-19, 7805DM-10   |  |

Fit&Go 3/3 Foam Inlay Socket/Wrench/ Grip Set - 45 Pcs



**FF1A5030**

|                   |   |          |
|-------------------|---|----------|
|                   |   |          |
| 52 x 445 x 543 mm | 1 | FF1A5030 |

|  |  |
|--|--|
| 111M-17, 111M-18, 111M-19, 111M-20, 111M-6, 111M-7, 111M-8, 111M-13, 111M-14, 111M-15, 111M-16, 111M-9, 111M-10, 111M-11, 111M-12  |  |
| 2951-180, 2951-250   |  |
| 7800DM-12, 7800DM-13, 7800DM-14, 7800DM-15, 7800DM-8, 7800DM-9, 7800DM-10, 7800DM-11, 7800DM-20, 7800DM-21, 7800DM-22, 7800DM-23, 7800DM-16, 7800DM-17, 7800DM-18, 7800DM-19, 7800DM-28, 7800DM-30, 7800DM-32, 7800DM-24, 7800DM-26, 7800DM-27 |  |
| 8155-1/2   |  |
| 3625N-32   |  |
| 8154-11  |  |
| 8160-5, 8160-10  |  |
| 8166   |  |

Fit&Go 3/3 Foam Inlay Socket and Wrench Set - 75 Pcs



**FF1A5032**

|                   |   |          |
|-------------------|---|----------|
|                   |   |          |
| 55 x 445 x 543 mm | 1 | FF1A5032 |

|   |  |
|---|--|
| 6700SM-10, 6700SM-11, 6700SM-8, 6700SM-9, 6700SM-14, 6700SM-12, 6700SM-13, 6700SM-4, 6700SM-6, 6700SM-7, 6700SM-5, 6700SM-4.5, 6700SM-5.5   |  |
| 6950  |  |
| 6954  |  |
| 6956  |  |
| 6960, 6962  |  |
| 6966  |  |
| 7400SM-6, 7400SM-7, 7400SM-10, 7400SM-11, 7400SM-8, 7400SM-9, 7400SM-14, 7400SM-15, 7400SM-12, 7400SM-13, 7400SM-18, 7400SM-19, 7400SM-16, 7400SM-17, 7400SM-22, 7400SM-20, 7400SM-21 |  |
| 7754  |  |

7755-3/8

7760, 7761, 7762

7766

7800DM-11, 7800DM-14, 7800DM-15, 7800DM-12, 7800DM-13, 7800DM-18, 7800DM-19, 7800DM-16, 7800DM-17, 7800DM-22, 7800DM-23, 7800DM-20, 7800DM-21, 7800DM-26, 7800DM-27, 7800DM-24, 7800DM-30, 7800DM-32, 7800DM-28, 7800DM-8, 7800DM-9, 7800DM-10, 7800DM-25, 7800DM-29

8155-1/2

111M-19, 111M-17, 111M-18, 111M-15, 111M-16, 111M-14, 111M-20

8154-11

8160-5, 8160-10

8166

Fit&Go 3/3 Foam Inlay Hose Clamp Set - 6 Pcs



**FF1A5036**

|                   |   |          |
|-------------------|---|----------|
|                   |   |          |
| 38 x 445 x 543 mm | 1 | FF1A5036 |

BE258

BE250

BE256P3

BE254A

Fit&Go 3/3 Foam Inlay 1/2" Impact Wrench Set - 12 Pcs



**FF1A5037**

|                   |   |          |
|-------------------|---|----------|
|                   |   |          |
| 75 x 445 x 543 mm | 1 | FF1A5037 |

BPC813

BP814A

BP824

BP110

BP118

Fit&Go 3/3 Foam Inlay Calliper Set for Brake - 50 Pcs



**FF1A5038**

45 x 445 x 543 mm 1 FF1A5038

**BBR300P50**

Fit&Go 3/3 Foam Inlay File/Pliers/Punch Set - 23 Pcs



**FF1A51**

40 x 445 x 543 mm 1 FF1A51

|  |  |  |
|--|--|--|
| 1-100-08-1-2                                   |  |  |
| 1-210-08-1-2                                   |  |  |
| 1-230-08-1-2                                   |  |  |
| 4-144-08-2-2                                   |  |  |
| 1-170-08-1-2                                   |  |  |
| 3735-4-120                                     |  |  |
| 3733-4, 3733-2, 3733-6                         |  |  |
| 3734-2, 3734-3, 3734-4, 3734-5, 3734-6, 3734-8 |  |  |
| 2800-180, 2800-150                             |  |  |
| 2890-140, 2890-180                             |  |  |
| 2900-150, 2900-180                             |  |  |
| 2990-140, 2990-180                             |  |  |

Fit&Go 3/3 Foam Inlay Screwdriver/Key Set - 38 Pcs



**FF1A53**

45 x 445 x 543 mm 1 FF1A53

|                                    |  |  |
|------------------------------------|--|--|
| BE-8800, BE-8811, BE-8821          |  |  |
| BE-8830                            |  |  |
| BE-8600, BE-8611, BE-8621          |  |  |
| BE-8630                            |  |  |
| BE-8910, BE-8915, BE-8920, BE-8925 |  |  |
| BE-9770                            |  |  |
| BE-9780                            |  |  |
| 3625S-44                           |  |  |
| 2800-225                           |  |  |
| 2890-210                           |  |  |

Fit&Go 3/3 Foam Inlay 1/4" + 3/8" Long Socket Set - 75 Pcs



**FF1A54**

35 x 445 x 543 mm 1 FF1A54

|        |  |
|--------|--|
| S1612L |  |
| S0810L |  |
| S330L  |  |

Fit&Go 3/3 Foam Inlay Wrench/Bit Set - 75 Pcs



**FF1A55**

40 x 445 x 543 mm 1 FF1A55

|  |  |  |
|--|--|--|
| A6700DZ-1/2, A6700DZ-1/4, A6700DZ-11/32, A6700DZ-3/16, A6700DZ-3/8, A6700DZ-5/16, A6700DZ-7/16, A6700DZ-7/32, A6700DZ-9/16, A6700DZ-9/32 |  |  |
|--|--|--|

|  |  |  |
|--|--|--|
| BE-9775  |  |  |
| SBS61  |  |  |
| SBS63-2, SBS63-6, SBS63-4  |  |  |
| SBS65  |  |  |
| SBS67  |  |  |
| SBS81  |  |  |
| 6956   |  |  |
| 6972H  |  |  |
| 7800DZ-1, 7800DZ-1/2, 7800DZ-11/16, 7800DZ-13/16, 7800DZ-15/16, 7800DZ-19/32, 7800DZ-3/4, 7800DZ-3/8, 7800DZ-5/8, 7800DZ-7/8, 7800DZ-9/16, 7800DZ-7/16 |  |  |
| 808050   |  |  |
| 6954   |  |  |
| 8160-10, 8160-5  |  |  |
| 8166   |  |  |
| 8154-11  |  |  |

Fit&Go 3/3 Foam Inlay Combination Wrench Set - 28 Pcs



**FF1A56**

63 x 445 x 543 mm 1 FF1A56

|  |  |  |
|--|--|--|
| 111Z-1, 111Z-1/2, 111Z-1/4, 111Z-11/16, 111Z-13/16, 111Z-15/16, 111Z-3/4, 111Z-3/8, 111Z-5/16, 111Z-5/8, 111Z-7/16, 111Z-7/8, 111Z-9/16    |  |  |
| 1320RZ-1/2-9/16, 1320RZ-1/4-5/16, 1320RZ-3/8-7/16, 1320RZ-5/16-11/32   |  |  |
| 6Z-1.1/16-1.1/4, 6Z-1-1.1/8, 6Z-1/2-9/16, 6Z-1/4-5/16, 6Z-15/16-1, 6Z-19/32-11/16, 6Z-25/32-13/16, 6Z-5/16-11/32, 6Z-5/8-3/4, 6Z-7/8-15/16 |  |  |
| 9031   |  |  |



Fit&Go 3/3 Foam Inlay Wrenches/Hand Hacksaw Set - 28 Pcs



**FF1A65**



50 x 445 x 543 mm

1 FF1A65

111M-19, 111M-17, 111M-18, 111M-24, 111M-21, 111M-22, 111M-7, 111M-8, 111M-6, 111M-11, 111M-12, 111M-9, 111M-10, 111M-15, 111M-16, 111M-13, 111M-14, 111M-20

1RM-8, 1RM-9, 1RM-12, 1RM-13, 1RM-10, 1RM-11, 1RM-17, 1RM-14, 1RM-19

319

Fit&Go 3/3 Foam Inlay Measuring Tape and Screwdriver Set - 50 Pcs



**FF1A66**



50 x 445 x 543 mm

1 FF1A66

038.055.100, 038.065.125, 038.080.150

039.001.100, 039.002.125

1178-SCRIBE

426TOR9

6972H

9045-B-250

BE-8010S, BE-8230S

BE-8040

BE-8150, BE-8155

BE-8800, BE-8811, BE-8821

BE-8830

MTB-5-25

SQZ150003

59S/31-1

Fit&Go 3/3 Foam Inlay Screwdriver/Wrench/Pliers Set - 28 Pcs



**FF1A67**



39 x 445 x 543 mm

1 FF1A67

9031

2101G-160IP

21HDG-180IP

2427 G-160 IP

2430 G-160 IP

8224 IP

BE-8600, BE-8611, BE-8621

BE-8630

BE-8910, BE-8915, BE-8920, BE-8925

7865

Fit&Go 3/3 Foam Inlay Files/Striking/Circlip Pliers/Hex Key Set - 30 Pcs



**FF1A68**



37 x 445 x 543 mm

1 FF1A68

1-100-08-1-2

1-170-08-1-2

1-210-08-1-2

1-230-08-1-2

2800-180

2890-180

2900-180

2990-180

3733-4, 3733-2, 3733-6

3734-8, 3734-5, 3734-6, 3734-3, 3734-4, 3734-2

3735-4-120

4-144-08-2-2

481-400

BE-9770

Fit&Go 3/3 Foam Inlay Automotive Bit Set and Clamping Tip Set - 105 Pcs



**FF1A70**

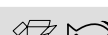

42 x 445 x 543 mm

1 FF1A70

BE5049

S560

Fit&Go 3/3 Foam Inlay Slotted/Phillips/T-Handle Screwdriver Set - 45 Pcs



**FF1A71**

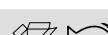

41 x 445 x 543 mm

1 FF1A71

901T-010-100, 901T-015-150, 901T-020-150, 901T-027-150, 901T-030-200, 901T-040-200, 901T-025-150, 901T-045-200, 901T-050-200

B190.055.125

B191.030.075, B191.040.100

B192.001.100, B192.002.125

B705.1/4.125

59/S31B



Fit&Go 3/3 Foam Inlay Automotive Pliers Set - 18 Pcs



**FF1A72**

38 x 445 x 543 mm 1 FF1A72

|  |  |
|--|--|
| 2101GC-160IP   |  |
| 2430 GC-200 IP   |  |
| 2630GC-180IP   |  |
| 2800-180   |  |
| 2890-180   |  |
| 2900-180   |  |
| 2953-200   |  |
| 2990-180   |  |
| 3640-200-C   |  |
| 3734N-10-150, 3734N-2-150, 3734N-3-150, 3734N-4-150, 3734N-5-150, 3734N-6-150, 3734N-8-150 |  |
| 479-16   |  |
| 3625W-35   |  |

Fit&Go 3/3 Foam Inlay Striking, Cutting, Pliers & Measuring Tape - 25 pcs



**FF1A82**

43 x 445 x 543 mm 1 FF1A82

|                 |  |
|-----------------|--|
| 3734S/6         |  |
| 479-16          |  |
| 3625W-35        |  |
| MTG-3-16        |  |
| KB18-01         |  |
| KSBG18-10DISPEN |  |
| 2101G-180IP     |  |
| 2678 G-180      |  |
| 2470 G-200      |  |
| 720031          |  |
| 8224 IP         |  |

Fit&Go 2/3 Foam Inlay Slotted Screwdriver Set - 9 Pcs



**FF1F1001**

40 x 362 x 445 mm 1 FF1F1001

|  |  |
|--|--|
| BE-8210, BE-8030, BE-8040, BE-8240, BE-8242, BE-8252, BE-8250L |  |
| BE-8255, BE-8257   |  |

Fit&Go 2/3 Foam Inlay Phillips Screwdriver Set - 11 Pcs



**FF1F1002**

40 x 362 x 445 mm 1 FF1F1002

|                                    |  |
|------------------------------------|--|
| BE-8020, BE-8040, BE-8242, BE-8252 |  |
| BE-8330                            |  |
| BE-8256, BE-8258                   |  |
| BE-8610, BE-8620, BE-8623          |  |
| BE-8602                            |  |

Fit&Go 2/3 Foam Inlay Slotted/Phillips Screwdriver Set - 11 Pcs



**FF1F1003**

38 x 362 x 445 mm 1 FF1F1003

|   |  |
|---|--|
| BE-8030, BE-8242, BE-8252                   |  |
| BE-8155                                     |  |
| BE-8870                                     |  |
| BE-8600, BE-8610, BE-8620, BE-8623, BE-8624 |  |
| 808050S                                     |  |

Fit&Go 2/3 Foam Inlay TORX® Screwdriver Set - 10 Pcs



**FF1F1004**

38 x 362 x 445 mm 1 FF1F1004

|   |  |
|---|--|
| BE-8904, BE-8907, BE-8908                                     |  |
| BE-7910, BE-7915, BE-7920, BE-7925, BE-7927, BE-7930, BE-7940 |  |

Fit&Go 2/3 Foam Inlay TORX®/Bit Screwdriver Set - 12 Pcs



**FF1F1005**

43 x 362 x 445 mm 1 FF1F1005

|  |  |
|--|--|
| BE-8908, BE-8909, BE-8910, BE-8915, BE-8920, BE-8925, BE-8927, BE-8930 |  |
| K6650-1/4-1P   |  |
| 808050S  |  |
| 808050   |  |
| 59S/31-3   |  |



Fit&Go 2/3 Foam Inlay Insulated Slotted/Phillips/Pozidriv Screwdriver Set - 8 Pcs



**FF1F1006**



40 x 362 x 445 mm

1 FF1F1006



BE-8230S, BE-8040S, BE-8050S, BE-8255S



BE-8810S, BE-8820S



BE-8610S, BE-8620S



Fit&Go 2/3 Foam Inlay TORX® T-Handle Screwdriver Set - 7 Pcs



**FF1F1007**



35 x 362 x 445 mm

1 FF1F1007



901T-010-100, 901T-015-150, 901T-020-150, 901T-025-150, 901T-027-150, 901T-030-200, 901T-040-200



Fit&Go 2/3 Foam Inlay Screwdriver/Hex Key/Bit Set - 49 Pcs



**FF1F1008**



38 x 362 x 445 mm

1 FF1F1008



B219.026



B705.1/4.125



B146.006.100



B145.006.100



BE-9770

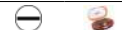

59S/31-1



Fit&Go 2/3 Foam Inlay Slotted/Phillips/Pozidriv/TORX Screwdriver Set - 14 Pcs



**FF1F1009**



38 x 362 x 445 mm

1 FF1F1009



B219.026



B219.025



B196.030.100



B195.002.025



B195.050.025



Fit&Go 2/3 Foam Inlay 1/4" Socket and Pear Head Ratchet Set - 44 Pcs



**FF1F2001**



37 x 362 x 445 mm

1 FF1F2001



6972H



6956



1998M-12



Fit&Go 2/3 Foam Inlay Socket/Bit Set with Magnetic Dish - 53 Pcs



**FF1F2002**



45 x 362 x 445 mm

1 FF1F2002



SL25L



2058/S26



6956



1419-MD



Fit&Go 2/3 Foam Inlay 3/8" Socket and Pear Head Ratchet Set - 36 Pcs



**FF1F2101**



37 x 362 x 445 mm

1 FF1F2101



A6800DM-4, A6800DM-5, A6800DM-5.5, A6800DM-6, A6800DM-7, A6800DM-8, A6800DM-9, A6800DM-10, A6800DM-11, A6800DM-12, A6800DM-13



6700SM-5, 6700SM-5.5, 6700SM-6, 6700SM-7, 6700SM-8, 6700SM-9, 6700SM-10, 6700SM-11, 6700SM-12, 6700SM-13, 6700SM-14



6709PH-1, 6709PH-2, 6709PH-3



6709PZ-1, 6709PZ-2



6709M-3, 6709M-4, 6709M-5, 6709M-6, 6709M-8



6709F-4.5, 6709F-5.5, 6709F-8



BE-9778



6950SL



7765



6954

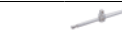

6962



6966



7400SM-7, 7400SM-8, 7400SM-9, 7400SM-10, 7400SM-11, 7400SM-12, 7400SM-13, 7400SM-14, 7400SM-15, 7400SM-16, 7400SM-17, 7400SM-18, 7400SM-19, 7400SM-20, 7400SM-21, 7400SM-22



7409M-4, 7409M-6, 7409M-8, 7409M-10



A7402DM-10, A7402DM-11, A7402DM-12, A7402DM-13



A7410DZ-5/16, A7410DZ-7/16, A7410DZ-9/16, A7410DZ-3/8, A7410DZ-5/8



7750SL



7762



7754



7766



7764



8164-1/2



7756





Fit&Go 2/3 Foam Inlay 3/8" Standard/Deep Socket Set - 34 Pcs



**FF1F2102**



40 x 362 x 445 mm

1 FF1F2102

S330L

Fit&Go 2/3 Foam Inlay 3/8" Socket Set - 38 Pcs

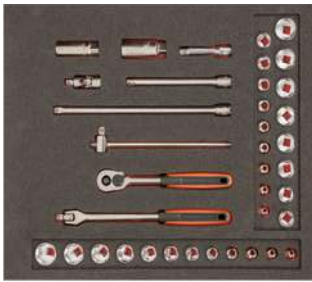

**FF1F2103**

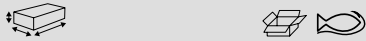

35 x 362 x 445 mm

1 FF1F2103

S380

Fit&Go 2/3 Foam Inlay 1/2" Socket and Round Head Ratchet Set - 35 Pcs



**FF1F2201**



50 x 362 x 445 mm

1 FF1F2201

7800SM-10, 7800SM-12, 7800SM-13, 7800SM-17, 7800SM-18, 7800SM-19, 7800SM-20, 7800SM-21, 7800SM-22, 7800SM-24, 7800SM-27, 7800SM-30, 7800SM-32

7800DM-10, 7800DM-11, 7800DM-12, 7800DM-13, 7800DM-14, 7800DM-15, 7800DM-16, 7800DM-17, 7800DM-18, 7800DM-19



7809M-5, 7809M-6, 7809M-7, 7809M-8, 7809M-10, 7809M-12



8150SL



8160-5, 8160-10



8166

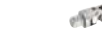

8154-11



8171



Fit&Go 2/3 Foam Inlay 1/2" Socket and Pear Head Ratchet Set - 24 Pcs



**FF1F2202**



50 x 362 x 445 mm

1 FF1F2202

S240

S81SL

Fit&Go 2/3 Foam Inlay Bit Set/Magnetic Dish Set - 50 Pcs



**FF1F5004**



35 x 362 x 445 mm

1 FF1F5004

BE5049

1419-MD

Fit&Go 2/3 Foam Inlay Turnbuckle Shock Absorber Set - 39 Pcs



**FF1F5013**

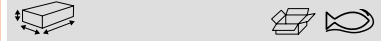

35 x 362 x 445 mm

1 FF1F5013

BS1000

Fit&Go 2/3 Foam Inlay 1/2" Deep Impact Socket Set - 27 Pcs



**FF1F2203**

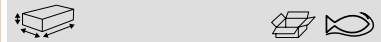

50 x 362 x 445 mm

1 FF1F2203

K7801M-10, K7801M-12, K7801M-13, K7801M-14, K7801M-15, K7801M-16, K7801M-17, K7801M-18, K7801M-19, K7801M-21, K7801M-22, K7801M-24

K7806M-10, K7806M-12, K7806M-13, K7806M-14, K7806M-15, K7806M-16, K7806M-17, K7806M-18, K7806M-19, K7806M-21, K7806M-22, K7806M-24, K7806M-27, K7806M-30, K7806M-32

Fit&Go 2/3 Foam Inlay Double Open End Wrench Set - 11 Pcs



**FF1F3001**



40 x 362 x 445 mm

1 FF1F3001

6M-6-7, 6M-8-9, 6M-10-11, 6M-12-13, 6M-14-15, 6M-16-18, 6M-17-19, 6M-20-22, 6M-21-23, 6M-24-27, 6M-30-32



Fit&Go 2/3 Foam Inlay Combination Wrench Set - 18 Pcs



**FF1F3002**



41 x 362 x 445 mm



1 FF1F3002

111M-6, 111M-7, 111M-8, 111M-9, 111M-10, 111M-11, 111M-12, 111M-13, 111M-14, 111M-15, 111M-16, 111M-17, 111M-18, 111M-19, 111M-21, 111M-22, 111M-24, 111M-27

Fit&Go 2/3 Foam Inlay Combination Wrench Set - 30 Pcs



**FF1F3003**



40 x 362 x 445 mm



1 FF1F3003

111M-6, 111M-7, 111M-8, 111M-9, 111M-10, 111M-11, 111M-12, 111M-13, 111M-14, 111M-15, 111M-16, 111M-17, 111M-18, 111M-19, 111M-20, 111M-21, 111M-22

1320SRM-14-19

1RMA-19-1/4-SQ

1RMA-19-1/2-SQ2

1RMA-13-10-BIT

BE-9778

Fit&Go 2/3 Foam Inlay Imperial Combination Wrench Set - 13 Pcs



**FF1F3004**



42 x 362 x 445 mm



1 FF1F3004

111Z-3/8, 111Z-11/16, 111Z-1, 111Z-1/2, 111Z-13/16, 111Z-5/16, 111Z-5/8, 111Z-15/16, 111Z-7/16, 111Z-3/4, 111Z-1/4, 111Z-9/16, 111Z-7/8

Fit&Go 2/3 Foam Inlay Combination Ratchet Wrench Set - 15 Pcs



**FF1F3005**



39 x 362 x 445 mm



1 FF1F3005

1RM-8, 1RM-10, 1RM-12, 1RM-13, 1RM-14, 1RM-15, 1RM-16, 1RM-17, 1RM-18, 1RM-19, 1RM-21, 1RM-22

1RMA-13-10-BIT

1RMA-19-1/2-SQ2

Fit&Go 2/3 Foam Inlay Combination Ratchet Wrench Set - 17 Pcs



**FF1F3006**



35 x 362 x 445 mm



1 FF1F3006

1RM-19, 1RM-21, 1RM-22, 1RM-24, 1RM-27, 1RM-30

Fit&Go 2/3 Foam Inlay Double Open Ring Offset Wrench Set - 10 Pcs



**FF1F3007**



47 x 362 x 445 mm



1 FF1F3007

2M-6-7, 2M-8-9, 2M-10-11, 2M-12-13, 2M-14-15, 2M-16-18, 2M-17-19, 2M-21-23, 2M-24-27, 2M-30-32

Fit&Go 2/3 Foam Inlay Double Socket Head Wrench Set - 9 Pcs



**FF1F3008**



38 x 362 x 445 mm



1 FF1F3008

4040M-6-7, 4040M-8-9, 4040M-10-11, 4040M-12-13, 4040M-14-15, 4040M-16-17, 4040M-18-19, 4040M-20-22, 4040M-21-23

Fit&Go 2/3 Foam Inlay Flare Nut Wrench Set - 8 Pcs



**FF1F3009**



35 x 362 x 445 mm



1 FF1F3009

1949M-8-9, 1949M-10-11, 1949M-12-13, 1949M-14-15, 1949M-17-19, 1949M-19-22, 1949M-24-27, 1949M-30-32



Fit&Go 2/3 Foam Inlay Combination Wrench Set - 17 Pcs



**FF1F3010**



35 x 362 x 445 mm

1 FF1F3010

1RM/S5



111M/SH12



Fit&Go 2/3 Foam Inlay Metric Combination Wrench and Ratcheting Ring Wrench Set - 13 Pcs



**FF1F3011**



35 x 362 x 445 mm

1 FF1F3011

S4RM/3T



111M/SH12



Fit&Go 2/3 Foam Inlay Wrench and Pliers Set - 8 Pcs



**FF1F4001**



35 x 362 x 445 mm

1 FF1F4001

2430 G-160 IP



2421 G-180 IP



2101G-160IP



2628 G-200



8224 IP



9029



2951-140, 2951-300



Fit&Go 2/3 Foam Inlay Scissors and Pliers Set - 8 Pcs



**FF1F4002**



35 x 362 x 445 mm

1 FF1F4002

2928-160



2951-250



SC127



2101G-160IP



2430 G-160 IP



2339 DIP



2628 G-180IP



8224 IP



Fit&Go 2/3 Foam Inlay Pliers Set - 4 Pcs



**FF1F4003**



35 x 362 x 445 mm

1 FF1F4003

2101G-160IP



8224 IP



2951-180



2430 G-200 IP



Fit&Go 2/3 Foam Inlay Circlip Pliers Set - 8 Pcs



**FF1F4004**



35 x 362 x 445 mm

1 FF1F4004

2800-140, 2800-180



2890-140, 2890-180



2900-140, 2900-180



2990-140, 2990-180



Fit&Go 2/3 Foam Inlay Insulated Cutter/Pliers Set - 5 Pcs



**FF1F4005**



38 x 362 x 445 mm

1 FF1F4005

2101S-160



2430 S-200



2427 S-200



8224 IP



2628 S-180





Fit&Go 2/3 Foam Inlay File/Measuring Tape/Pliers Set - 10 Pcs



**FF1F5001**



|                   |   |          |  |
|-------------------|---|----------|--|
|                   |   |          |  |
| 40 x 362 x 445 mm | 1 | FF1F5001 |  |

|               |  |  |
|---------------|--|--|
| 1-100-08-1-2  |  |  |
| 1-160-08-1-2  |  |  |
| 1-170-08-1-2  |  |  |
| 1-210-08-1-2  |  |  |
| 1-230-08-1-2  |  |  |
| 2430 G-200 IP |  |  |
| 2628G-200IP   |  |  |
| 7224          |  |  |
| 2101G-160IP   |  |  |
| MTB-3-16      |  |  |

Fit&Go 2/3 Foam Inlay Tin Snip/Rivet Gun/Measuring Tape Set - 5 Pcs



**FF1F5002**



|                   |   |          |  |
|-------------------|---|----------|--|
|                   |   |          |  |
| 38 x 362 x 445 mm | 1 | FF1F5002 |  |

|             |  |
|-------------|--|
| 2681        |  |
| MA401       |  |
| MA411       |  |
| 1178-SCRIBE |  |
| MTG-5-19    |  |

Fit&Go 2/3 Foam Inlay Pliers/Adjustable Wrench Set - 5 Pcs



**FF1F5003**



|                   |   |          |
|-------------------|---|----------|
|                   |   |          |
| 35 x 362 x 445 mm | 1 | FF1F5003 |

|            |  |
|------------|--|
| 8224       |  |
| 2101G-160  |  |
| 2430 G-160 |  |
| 8071       |  |
| 2951-250   |  |

Fit&Go 2/3 Foam Inlay Cutting Tool Set - 8 Pcs



**FF1F5005**



|                   |   |
|-------------------|---|
|                   |   |
| 40 x 362 x 445 mm | 1 |

|                |  |
|----------------|--|
| 317            |  |
| 3906-300-24-5P |  |
| 268            |  |
| 2446           |  |

Fit&Go 2/3 Foam Inlay End Terminal Pliers/Multimeter Set - 4 Pcs



**FF1F5006**



|                   |   |          |
|-------------------|---|----------|
|                   |   |          |
| 50 x 362 x 445 mm | 1 | FF1F5006 |

CR W 01

CR B 05

3418 A

BMMTRMS1

Fit&Go 2/3 Foam Inlay Puller Set - 5 Pcs



**FF1F5007**



|                   |   |
|-------------------|---|
|                   |   |
| 45 x 362 x 445 mm | 1 |

4543-1, 4543-2, 4543-3

4545-2

4541-A

Fit&Go 2/3 Foam Inlay Knife/Awl/Hook Set - 11 Pcs



**FF1F5008**



|                   |   |          |  |
|-------------------|---|----------|--|
|                   |   |          |  |
| 37 x 362 x 445 mm | 1 | FF1F5008 |  |

2633/S4, 2633L/S4

2489

2485

KE18-01

Fit&Go 2/3 Foam Inlay Puller/Joint Fork Set - 5 Pcs



**FF1F5009**



60 x 362 x 445 mm

1 FF1F5009

BS618, BS623

4545-2

4545-N11

4532-0

Fit&Go 2/3 Foam Inlay Mix Brush/Ring Wrench Set - 9 Pcs



**FF1F5010**



45 x 362 x 445 mm

1 FF1F5010

BBR6135

BBR6131

BBR110

1949M-8-9, 1949M-10-11

7809M-6, 7809M-8, 7809M-10

783

Fit&Go 2/3 Foam Inlay 1/2" Impact Wrench Set - 7 Pcs



**FF1F5011**



100 x 362 x 445 mm

1 FF1F5011

BP815

BP821

BP822

BP823

Fit&Go 2/3 Foam Inlay 1/2" Mini Impact Wrench Set - 9 Pcs



**FF1F5012**



55 x 362 x 445 mm

1 FF1F5012

BWSS12P317, BWSS12P319, BWSS12P321

BPC814

BWTB12P120

GL008-10

783

8157-15

Fit&Go 1/3 Foam Inlay 4 Slotted/3 Phillips Screwdriver Set - 7 Pcs



**FF1E1001**



38 x 181 x 445 mm

1 FF1E1001

BE-8030, BE-8040, BE-8242, BE-8252

BE-8610, BE-8620, BE-8623

Fit&Go 1/3 Foam Inlay 5 Slotted/2 Phillips Screwdriver Set - 7 Pcs



**FF1E1002**



39 x 181 x 445 mm

1 FF1E1002

BE-8242, BE-8040, BE-8030

BE-8257, BE-8255

BE-8611, BE-8621

Fit&Go 1/3 Foam Inlay Slotted/Pozidriv Screwdriver Set - 6 Pcs



**FF1E1003**



38 x 181 x 445 mm

1 FF1E1003

BE-8240

BE-8150, BE-8255, BE-8256

BE-8810, BE-8820

Fit&Go 1/3 Foam Inlay Slotted/Phillips/Pozidriv Screwdriver Set - 8 Pcs



**FF1E1004**



40 x 181 x 445 mm

1 FF1E1004

BE-8340, BE-8350

BE-8600, BE-8610

BE-8811, BE-8800, BE-8820L, BE-8821





Fit&Go 1/3 Foam Inlay Slotted/Phillips/  
Poizidriv/Hex Screwdriver Set - 7 Pcs



ergo



**FF1E1005**



40 x 181 x 445 mm

1 FF1E1005

BE-8210, BE-8010



BE-8811, BE-8821, BE-8800



BE-8600



BE-8830



Fit&Go 1/3 Foam Inlay Slotted/Phillips/  
Poizidriv Screwdriver Set - 6 Pcs



ergo



**FF1E1006**



40 x 181 x 445 mm

1 FF1E1006

BE-8210



BE-8610, BE-8620



BE-8630



BE-8811, BE-8820



Fit&Go 1/3 Foam Inlay TORX® Screwdriver  
Set T10-T40 - 6 Pcs



ergo



**FF1E1007**



40 x 181 x 445 mm

1 FF1E1007

BE-8910, BE-8915, BE-8920, BE-8925,  
BE-8930, BE-8940



Fit&Go 1/3 Foam Inlay TORX® Tamper-  
Resistant Screwdriver Set TR10-TR40 - 6  
Pcs



ergo



**FF1E1008**



38 x 181 x 445 mm

1 FF1E1008

BE-7910, BE-7930, BE-7925, BE-7920,  
BE-7915, BE-7940



Fit&Go 1/3 Foam Inlay TORX® Screwdriver  
Set T8-T30 - 6 Pcs



ergo



**FF1E1009**



38 x 181 x 445 mm

1 FF1E1009

BE-8908, BE-8910, BE-8915, BE-8920,  
BE-8925, BE-8930



Fit&Go 1/3 Foam Inlay Slotted/Phillips  
Insulated Screwdriver Set 39 mm x 181  
mm x 445 mm - 6 Pcs



ergo



**FF1E1010**



39 x 181 x 445 mm

1 FF1E1010

BE-8010S, BE-8230S, BE-8050S,  
BE-8255S



BE-8610S, BE-8620S



Fit&Go 1/3 Foam Inlay Slotted/Phillips  
Insulated Screwdriver Set 45 mm x 181  
mm x 445 mm - 6 Pcs



ergo



**FF1E1011**



45 x 181 x 445 mm

1 FF1E1011

BE-8040S, BE-8050S, BE-8255S,  
BE-8065S



BE-8610S, BE-8620S



Fit&Go 1/3 Foam Inlay 1/4" Socket and  
Pear Head Ratchet Set - 37 Pcs



**FF1E2001**



38 x 181 x 445 mm

1 FF1E2001

6700SM-4, 6700SM-5, 6700SM-5.5,  
6700SM-6, 6700SM-7, 6700SM-8,  
6700SM-9, 6700SM-10, 6700SM-11,  
6700SM-12, 6700SM-13, 6700SM-14



6700TORX-E4, 6700TORX-E5,  
6700TORX-E6, 6700TORX-E7,  
6700TORX-E8, 6700TORX-E10



6709M-3, 6709M-4, 6709M-5, 6709M-6,  
6709M-8



6709TORX-T8, 6709TORX-T9,  
6709TORX-T10, 6709TORX-T15,  
6709TORX-T20, 6709TORX-T25,  
6709TORX-T30, 6709TORX-T27,  
6709TORX-T40



6950SL



6954



6956



6960



6966



Fit&Go 1/3 Foam Inlay 1/4" Socket and Pear Head Ratchet Set - 45 Pcs



**FF1E2002**



38 x 181 x 445 mm

1 FF1E2002

- 6700SM-4, 6700SM-4.5, 6700SM-5, 6700SM-5.5, 6700SM-6, 6700SM-7, 6700SM-8, 6700SM-9, 6700SM-10, 6700SM-11, 6700SM-12, 6700SM-13, 6700SM-14
- 6709PZ-1, 6709PZ-3, 6709PZ-2
- 6709PH-1, 6709PH-2, 6709PH-3
- 6709TORX-T10, 6709TORX-T15, 6709TORX-T20, 6709TORX-T25, 6709TORX-T30, 6709TORX-T40
- 6709F-4.5, 6709F-5.5, 6709F-8
- 6709M-3, 6709M-4, 6709M-5, 6709M-6, 6709M-8
- 1998M-3, 1998M-2.5, 1998M-2, 1998M-1.5
- 6950SL
- 6962-W
- 6966
- 6956
- 6960, 6961
- 7765
- 6954

Fit&Go 1/3 Foam Inlay 1/4" Socket and Pear Head Ratchet Set - 19 Pcs



**FF1E2003**



38 x 181 x 445 mm

1 FF1E2003

- 6700SM-5, 6700SM-5.5, 6700SM-6, 6700SM-7, 6700SM-8, 6700SM-9, 6700SM-10, 6700SM-11, 6700SM-12, 6700SM-13, 6700SM-14
- BE-9778
- 6950SL
- 6956
- 6962

6966

7765

6954

1998M-12

Fit&Go 1/3 Foam Inlay 1/4" Socket and Pear Head Ratchet Set - 48 Pcs



**FF1E2004**



44 x 181 x 445 mm

1 FF1E2004

- A6700DM-8, A6700DM-9, A6700DM-10, A6700DM-11, A6700DM-12, A6700DM-13, A6700DM-14, A6700DM-5, A6700DM-5.5, A6700DM-6, A6700DM-7
- 808050S
- 6950SL
- 6966
- 6972H
- 6962
- 7765
- 59S/31-1

Fit&Go 1/3 Foam Inlay 1/4" Socket and Pear Head Ratchet Set - 17 Pcs



**FF1E2005**



35 x 181 x 445 mm

1 FF1E2005

- 6700SM-5.5, 6700SM-6, 6700SM-7, 6700SM-8, 6700SM-9, 6700SM-10, 6700SM-11, 6700SM-12, 6700SM-13, 6700SM-14
- 6950RN
- 6962, 6960
- 6966
- 6954
- 6956
- 6972H

Fit&Go 1/3 Foam Inlay 1/4" Socket and Round Head Ratchet Set - 35 Pcs



**FF1E2006**



39 x 181 x 445 mm

1 FF1E2006

- 6700SZ-5/16, 6700SZ-5/32, 6700SZ-11/32, 6700SZ-7/16, 6700SZ-9/32, 6700SZ-3/16, 6700SZ-3/8, 6700SZ-7/32, 6700SZ-1/4, 6700SZ-1/2, 6700SZ-9/16
- 6709PZ-1, 6709PZ-2, 6709PZ-3
- 6709PH-1, 6709PH-2, 6709PH-3
- 6709TORX-T8, 6709TORX-T10, 6709TORX-T15, 6709TORX-T20, 6709TORX-T25, 6709TORX-T30
- 6709F-4.5, 6709F-6.5, 6709F-8
- 6950RN
- 6954
- 6972H
- 6960, 6962
- 6963
- 6966
- 6956
- 7765

Fit&Go 1/3 Foam Inlay 1/4" Socket and Round Head Ratchet Set - 24 Pcs



**FF1E2007**



35 x 181 x 445 mm

1 FF1E2007

- 6700SZ-9/32, 6700SZ-3/16, 6700SZ-3/8, 6700SZ-1/4, 6700SZ-7/16, 6700SZ-7/32, 6700SZ-1/2, 6700SZ-11/32
- 1995Z-5/64, 1995Z-5/32, 1995Z-3/8, 1995Z-3/32, 1995Z-7/32, 1995Z-1/8, 1995Z-5/16, 1995Z-3/16, 1995Z-1/4
- 6950RN
- 6954
- 6972H
- 6960, 6962
- 6956
- 6966



Fit&Go 1/3 Foam Inlay 1/4" Socket and Round Head Ratchet Set - 26 Pcs



**FF1E2008**



35 x 181 x 445 mm 1 FF1E2008

|   |  |  |
|---|--|--|
| 6700SM-5.5, 6700SM-6, 6700SM-7, 6700SM-8, 6700SM-9, 6700SM-10, 6700SM-11, 6700SM-12, 6700SM-13, 6700SM-14 |  |  |
| 1995M-2, 1995M-3, 1995M-4, 1995M-5, 1995M-6, 1995M-7, 1995M-8, 1995M-9, 1995M-10                          |  |  |
| 6950RN  |  |  |
| 6960, 6962  |  |  |
| 6966  |  |  |
| 6954  |  |  |
| 6956  |  |  |
| 6972H   |  |  |

Fit&Go 1/3 Foam Inlay 3/8" Socket and Pear Head Ratchet Set - 25 Pcs



**FF1E2102**

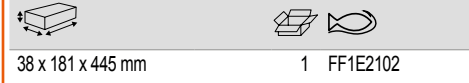

38 x 181 x 445 mm 1 FF1E2102

|  |  |  |
|--|--|--|
| 7400SM-6, 7400SM-7, 7400SM-8, 7400SM-9, 7400SM-10, 7400SM-11, 7400SM-12, 7400SM-13, 7400SM-14, 7400SM-15, 7400SM-16, 7400SM-17, 7400SM-18, 7400SM-19 |  |  |
| 7409M-4, 7409M-5, 7409M-6, 7409M-8, 7409M-10   |  |  |
| 7750SL   |  |  |
| 7760, 7762   |  |  |
| 7754   |  |  |
| 7768   |  |  |
| 8164-1/2   |  |  |

Fit&Go 1/3 Foam Inlay 3/8" Socket and Round Head Ratchet Set - 20 Pcs



**FF1E2104**

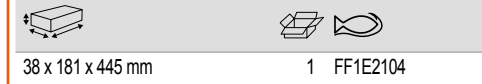

38 x 181 x 445 mm 1 FF1E2104

|  |  |  |
|--|--|--|
| 7400SM-6, 7400SM-8, 7400SM-9, 7400SM-10, 7400SM-11, 7400SM-12, 7400SM-13, 7400SM-14, 7400SM-15, 7400SM-16, 7400SM-17, 7400SM-18, 7400SM-19, 7400SM-20, 7400SM-22 |  |  |
| 7750RN   |  |  |
| 7761, 7762   |  |  |
| 7766   |  |  |
| 7768   |  |  |

Fit&Go 1/3 Foam Inlay 3/8" Socket and Pear Head Ratchet Set - 24 Pcs



**FF1E2101**



40 x 181 x 445 mm 1 FF1E2101

|  |  |  |
|--|--|--|
| 7400SM-6, 7400SM-7, 7400SM-8, 7400SM-9, 7400SM-10, 7400SM-11, 7400SM-12, 7400SM-13, 7400SM-14, 7400SM-15, 7400SM-16, 7400SM-17, 7400SM-18, 7400SM-19, 7400SM-20, 7400SM-22 |  |  |
| 7750SL   |  |  |
| 7760, 7761, 7762   |  |  |
| 7764   |  |  |
| 7766   |  |  |
| 7754   |  |  |
| 8164-1/2   |  |  |

Fit&Go 1/3 Foam Inlay 3/8" Socket and Pear Head Ratchet Set - 28 Pcs



**FF1E2103**



38 x 181 x 445 mm 1 FF1E2103

|   |  |  |
|---|--|--|
| 7400SM-7, 7400SM-8, 7400SM-9, 7400SM-10, 7400SM-11, 7400SM-12, 7400SM-13, 7400SM-14, 7400SM-15, 7400SM-16, 7400SM-17, 7400SM-18, 7400SM-19, 7400SM-20, 7400SM-21, 7400SM-22 |  |  |
| 7400TORX-E8, 7400TORX-E10, 7400TORX-E12, 7400TORX-E14, 7400TORX-E16, 7400TORX-E18   |  |  |
| 7750SL  |  |  |
| 7760, 7762  |  |  |
| 7768  |  |  |
| 7766  |  |  |
| SBS705  |  |  |

Fit&Go 1/3 Foam Inlay 3/8" Socket and Bit Driver Set - 28 Pcs



**FF1E2105**



35 x 181 x 445 mm 1 FF1E2105

|   |  |  |
|---|--|--|
| 7400TORX-E8, 7400TORX-E10, 7400TORX-E11, 7400TORX-E12, 7400TORX-E14, 7400TORX-E16, 7400TORX-E18 |  |  |
| 7409TORX-T25, 7409TORX-T30, 7409TORX-T40, 7409TORX-T45, 7409TORX-T50                            |  |  |
| 7409TORX-T25-L, 7409TORX-T30-L, 7409TORX-T40-L, 7409TORX-T45-L, 7409TORX-T50-L                  |  |  |
| 7409M-4, 7409M-5, 7409M-6, 7409M-8, 7409M-10  |  |  |
| 7409F-6.5, 7409F-8, 7409F-10  |  |  |
| 7409PH-1, 7409PH-2, 7409PH-3  |  |  |



Fit&Go 1/3 Foam Inlay 1/2" Socket and Round Head Ratchet Set - 21 Pcs



**FF1E2201**



44 x 181 x 445 mm 1 FF1E2201

- 7800SM-10, 7800SM-11, 7800SM-12, 7800SM-13, 7800SM-14, 7800SM-15, 7800SM-17, 7800SM-18, 7800SM-19, 7800SM-20, 7800SM-21, 7800SM-22, 7800SM-24, 7800SM-27
- 7805SM-16, 7805SM-21
- 8150SL
- 8160-5, 8160-10
- 8166
- 8171

Fit&Go 1/3 Foam Inlay 1/2" Socket and Pear Head Ratchet Set - 21 Pcs



**FF1E2202**



45 x 181 x 445 mm 1 FF1E2202

- 7800SM-8, 7800SM-9, 7800SM-10, 7800SM-11, 7800SM-12, 7800SM-13, 7800SM-14, 7800SM-15, 7800SM-16, 7800SM-17, 7800SM-18, 7800SM-19, 7800SM-20, 7800SM-21, 7800SM-23, 7800SM-24, 7800SM-27
- 8150-1/2
- 8160-5, 8160-10
- 8166

Fit&Go 1/3 Foam Inlay 1/2" Socket and Round Head Ratchet Set - 22 Pcs



**FF1E2203**



50 x 181 x 445 mm 1 FF1E2203

- 7800SM-8, 7800SM-9, 7800SM-10, 7800SM-11, 7800SM-12, 7800SM-13, 7800SM-14, 7800SM-15, 7800SM-16, 7800SM-17, 7800SM-18, 7800SM-19, 7800SM-22, 7800SM-21, 7800SM-24, 7800SM-27, 7800SM-30, 7800SM-32
- 8150RN-1/2
- 8160-5, 8160-10
- 8166

Fit&Go 1/3 Foam Inlay 1/2" Socket and Round Head Ratchet Set - 15 Pcs



**FF1E2204**



45 x 181 x 445 mm 1 FF1E2204

- 7800DZ-1/2, 7800DZ-3/4, 7800DZ-19/32, 7800DZ-7/8, 7800DZ-7/16, 7800DZ-11/16, 7800DZ-9/16, 7800DZ-13/16, 7800DZ-3/8, 7800DZ-5/8, 7800DZ-15/16
- 8150RN-1/2
- 8160-5, 8160-10
- 8166

Fit&Go 1/3 Foam Inlay 1/2" Socket Set - 28 Pcs



**FF1E2205**



50 x 181 x 445 mm 1 FF1E2205

- 7800DM-10, 7800DM-11, 7800DM-12, 7800DM-13, 7800DM-14, 7800DM-15, 7800DM-16, 7800DM-17, 7800DM-18, 7800DM-19, 7800DM-20, 7800DM-21, 7800DM-22, 7800DM-23, 7800DM-24, 7800DM-25, 7800DM-26, 7800DM-27, 7800DM-28, 7800DM-30, 7800DM-32
- 7809M-6, 7809M-7, 7809M-8, 7809M-9, 7809M-10, 7809M-12, 7809M-14

Fit&Go 1/3 Foam Inlay 1/2" Socket Set - 27 Pcs



**FF1E2206**



50 x 181 x 445 mm 1 FF1E2206

- 7800SM-10, 7800SM-11, 7800SM-12, 7800SM-13, 7800SM-14, 7800SM-15, 7800SM-16, 7800SM-17, 7800SM-18, 7800SM-19, 7800SM-20, 7800SM-21, 7800SM-22, 7800SM-23, 7800SM-24, 7800SM-25, 7800SM-26, 7800SM-27, 7800SM-28, 7800SM-30, 7800SM-32
- 7809XZN-8, 7809XZN-10
- 7809PZ-2, 7809PZ-3
- 7809F-8, 7809F-10



Fit&Go 1/3 Foam Inlay 1/2" Socket Set/Bit Set/Key Set - 25 Pcs



**FF1E2207**



40 x 181 x 445 mm

1 FF1E2207

7809TORX-T20, 7809TORX-T25,  
7809TORX-T27, 7809TORX-T30,  
7809TORX-T40, 7809TORX-T55,  
7809TORX-T45, 7809TORX-T50,  
7809TORX-T60



7800TORX-E8, 7800TORX-E10,  
7800TORX-E12, 7800TORX-E14,  
7800TORX-E16, 7800TORX-E18,  
7800TORX-E20, 7800TORX-E24



BE-9675



Fit&Go 1/3 Foam Inlay 1/2" Bit Driver Set - 12 Pcs



**FF1E2208**



35 x 181 x 445 mm

1 FF1E2208

7809M-6, 7809M-7, 7809M-8, 7809M-9,  
7809M-10, 7809M-12, 7809M-14,  
7809M-17



7809M-5-180, 7809M-6-140, 7809M-8-120,  
7809M-10-140



Fit&Go 1/3 Foam Inlay 1/2" Bit Driver Set - 20 Pcs



**FF1E2209**



35 x 181 x 445 mm

1 FF1E2209

7809M-5, 7809M-6, 7809M-7, 7809M-8,  
7809M-10, 7809M-12, 7809M-14,  
7809M-17



7809TORX-T25, 7809TORX-T27,  
7809TORX-T30, 7809TORX-T40,  
7809TORX-T45, 7809TORX-T50,  
7809TORX-T55, 7809TORX-T60



7809XZN-6, 7809XZN-8, 7809XZN-10,  
7809XZN-12



Fit&Go 1/3 Foam Inlay 1/2" Bit Driver Set/Impact Socket Set - 14 Pcs



**FF1E2210**



38 x 181 x 445 mm

1 FF1E2210

7809M-5, 7809M-6, 7809M-7, 7809M-8,  
7809M-10, 7809M-12, 7809M-14,  
7809M-17, 7809M-19



BE-7606, BE-7607



BWSS12P317, BWSS12P319,  
BWSS12P321



Fit&Go 1/3 Foam Inlay 1/2" Socket Set - 21 Pcs



**FF1E2211**



50 x 181 x 445 mm

1 FF1E2211

7993S0050, 7993S0060, 7993S0080,  
7993S0100, 7993S0120, 7993S0140,  
7993S0170, 7993S0190



7994S0300, 7994S0400, 7994S0450,  
7994S0500, 7994S0550, 7994S0600



K7801TORX-E10, K7801TORX-E12,  
K7801TORX-E14, K7801TORX-E16,  
K7801TORX-E18, K7801TORX-E20,  
K7801TORX-E24



Fit&Go 1/3 Foam Inlay 1/2" Socket Set - 12 Pcs



**FF1E2212**



40 x 181 x 445 mm

1 FF1E2212

K7801M-10, K7801M-12, K7801M-13,  
K7801M-14, K7801M-15, K7801M-16,  
K7801M-17, K7801M-18, K7801M-19,  
K7801M-21, K7801M-22, K7801M-24





Fit&Go 1/3 Foam Inlay 1/2" Power Deep Socket Set - 15 Pcs



**FF1E2213**

45 x 181 x 445 mm 1 FF1E2213

- K7806M-10, K7806M-12, K7806M-13, K7806M-14, K7806M-15, K7806M-16, K7806M-17, K7806M-18, K7806M-19, K7806M-21, K7806M-22, K7806M-24, K7806M-27, K7806M-30, K7806M-32

Fit&Go 1/3 Foam Inlay 1/2" Socket Set - 13 Pcs



**FF1E2501**

35 x 181 x 445 mm 1 FF1E2501

- A7402DM-10, A7402DM-11, A7402DM-12, A7402DM-13, A7402DM-14
- 7805SM-12, 7805SM-13, 7805SM-14, 7805SM-15, 7805SM-16, 7805SM-17, 7805SM-18, 7805SM-19

Fit&Go 1/3 Foam Inlay 1/2" to 3/4" Power Socket Set - 7 Pcs



**FF1E2502**

45 x 181 x 445 mm 1 FF1E2502

- K560F-4, K560F-5
- K8167S
- K8160D-1, K8160D-2
- K7764D
- K8964D

Fit&Go 1/3 Foam Inlay Socket/Extractor Set - 35 Pcs



**FF1E5005**

36 x 181 x 445 mm 1 FF1E5005

- BWTSP16
- 1418S

Fit&Go 1/3 Foam Inlay Socket/Torsion Bar Set - 6 Pcs



**FF1E5006**

42 x 181 x 445 mm 1 FF1E5006

- D/S14
- BWSS12P3
- BWTB12P120, BWTB12P110

Fit&Go 1/3 Foam Inlay Mix Oil Plug Socket Set - 17 Pcs



**FF1E5009**

36 x 181 x 445 mm 1 FF1E5009

- BE6217

Fit&Go 1/3 Foam Inlay Double Open End Wrench Set - 8 Pcs



**FF1E3001**

47 x 181 x 445 mm 1 FF1E3001

- 6M-6-7, 6M-8-9, 6M-10-11, 6M-12-13, 6M-14-15, 6M-16-17, 6M-18-19, 6M-21-23, 6M-22-24

Fit&Go 1/3 Foam Inlay Double Open End Wrench Set - 3 Pcs



**FF1E3002**

35 x 181 x 445 mm 1 FF1E3002

- 6M-25-28, 6M-27-29, 6M-30-32



Fit&Go 1/3 Foam Inlay Double Open End Wrench Set - 9 Pcs



**FF1E3003**

41 x 181 x 445 mm 1 FF1E3003

6Z-1/2-9/16, 6Z-15/16-1, 6Z-5/16-11/32, 6Z-5/8-3/4, 6Z-3/8-7/16, 6Z-25/32-13/16, 6Z-19/32-11/16, 6Z-1/4-5/16, 6Z-3/4-7/8

Fit&Go 1/3 Foam Inlay Combination Ratcheting Wrench Set - 10 Pcs



**FF1E3004**

39 x 181 x 445 mm 1 FF1E3004

1RM-10, 1RM-9, 1RM-8, 1RM-14, 1RM-13, 1RM-12, 1RM-11, 1RM-17, 1RM-16, 1RM-15

Fit&Go 1/3 Foam Inlay Combination Ratcheting Wrench Set - 40 Pcs



**FF1E3005**

42 x 181 x 445 mm 1 FF1E3005

59S/31-1  
6966  
41RM-8, 41RM-10, 41RM-12, 41RM-13, 41RM-14, 41RM-17, 41RM-19  
8166

Fit&Go 1/3 Foam Inlay Ratcheting Wrench Set - 8 Pcs



**FF1E3006**

35 x 181 x 445 mm 1 FF1E3006

1320RM-6-7, 1320RM-8-9, 1320RM-10-11, 1320RM-12-13, 1320RM-14-15, 1320RM-16-17, 1320RM-18-19, 1320RM-22-24

Fit&Go 1/3 Foam Inlay Double Open Ring Offset Wrench Set - 7 Pcs



**FF1E3007**

35 x 181 x 445 mm 1 FF1E3007

2M-6-7, 2M-8-9, 2M-10-11, 2M-12-13, 2M-14-15, 2M-16-17, 2M-18-19

Fit&Go 1/3 Foam Inlay Double Open End Pipe Wrench Set - 9 Pcs



**FF1E3008**

50 x 181 x 445 mm 1 FF1E3008

27M-8-9, 27M-10-11, 27M-12-13, 27M-14-15, 27M-16-17, 27M-18-19, 27M-20-22, 27M-21-23, 27M-24-27

Fit&Go 1/3 Foam Inlay Pliers Set - 4 Pcs



**FF1E4001**

35 x 181 x 445 mm 1 FF1E4001

2628 G-180IP

8231 IP

2430 G-200 IP

2101G-160IP

Fit&Go 1/3 Foam Inlay Circlip Pliers Set - 4 Pcs



**FF1E4002**

35 x 181 x 445 mm 1 FF1E4002

2900-180

2890-180

2990-180

2800-180

Fit&Go 1/3 Foam Inlay Wrench and Pliers Set - 3 Pcs



**FF1E5007**

38 x 181 x 445 mm 1 FF1E5007

1410

9033

8225

Fit&Go 1/3 Foam Inlay Measuring Tool Set - 7 Pcs



**FF1E5001**



45 x 181 x 445 mm

1 FF1E5001

|             |  |
|-------------|--|
| MTB-5-25    |  |
| 8045LVDE    |  |
| WR2-MM      |  |
| 1544        |  |
| 1178-SCRIBE |  |
| 5515T       |  |
| 1150D       |  |

Fit&Go 1/3 Foam Inlay Hammer/Punch/Impact Driver Set - 35 Pcs



**FF1E5004**



36 x 181 x 445 mm

1 FF1E5004

|         |  |
|---------|--|
| 481-400 |  |
| 3734S/6 |  |
| 7865    |  |

Fit&Go 1/3 Foam Inlay Hammer/Flat Chisel/Cotter Pin Punch Set - 11 Pcs



**FF1E5002**



35 x 181 x 445 mm

1 FF1E5002

|  |  |
|--|--|
| 3740-150, 3740-175, 3740-200                   |  |
| 3734-2, 3734-3, 3734-4, 3734-5, 3734-6, 3734-8 |  |
| 481-100  |  |
| 1157   |  |

Fit&Go 1/3 Foam Inlay Hammer/Flat Chisel/Drift Punch Set - 11 Pcs



**FF1E5003**



35 x 181 x 445 mm

1 FF1E5003

|  |  |
|--|--|
| 481-300                                |  |
| 3735-5-120                             |  |
| 3739-300                               |  |
| 3740-100, 3740-125, 3740-150, 3740-200 |  |
| 3733-2, 3733-3, 3733-4, 3733-5         |  |

Fit&Go 1/3 Foam Inlay Spark Plug Socket and Pliers Set - 4 Pcs



**FF1E5008**



37 x 181 x 445 mm

1 FF1E5008

|                      |  |
|----------------------|--|
| 7805ZZ-16, 7805ZZ-21 |  |
| BE1P                 |  |
| BE61110              |  |

Fit&Go 1/3 Foam Inlay ERGO™ Blade Screwdriver Set - 6 pcs Retail Pack



**FF1E1012EH**



55 x 185 x 480 mm

1 FF1E1012EH

|                  |  |
|------------------|--|
| BE-8030          |  |
| BE-8150          |  |
| BE-8621, BE-8611 |  |
| BE-8811, BE-8821 |  |

Fit&Go 1/3 Foam Inlay Torx® Screwdriver Set T8-T30 - 6 pcs Retail Pack



**FF1E1009EH**



55 x 185 x 480 mm

1 FF1E1009EH

|  |  |
|--|--|
| BE-8908, BE-8910, BE-8915, BE-8920, BE-8925, BE-8930 |  |
|--|--|

Fit&Go 1/3 Foam Inlay ERGO™ Through Blade Screwdriver Set - 6 pcs Retail Pack



**FF1E1013EH**



55 x 185 x 480 mm

1 FF1E1013EH

|  |  |
|--|--|
| BE-8135TB, BE-8145TB, BE-8150TB, BE-8155TB |  |
| BE-8810TB, BE-8820TB                       |  |



Fit&Go 1/3 Foam Inlay 1/4" Socket Set & Bit Set - 46 pcs Retail Pack



**FF1E2009EH**

55 x 185 x 480 mm 1 FF1E2009EH

|  |  |  |
|--|--|--|
| 59/S31B-IP   |  |  |
| 6700SM-4, 6700SM-4.5, 6700SM-5, 6700SM-5.5, 6700SM-6, 6700SM-7, 6700SM-8, 6700SM-9, 6700SM-10, 6700SM-11, 6700SM-12, 6700SM-13 |  |  |
| 6962-W   |  |  |
| 6972H  |  |  |
| 6950SL   |  |  |

Fit&Go 1/3 Foam Inlay 1/4" Deep Socket Set - 11 pcs Retail Pack



**FF1E2214EH**

55 x 185 x 480 mm 1 FF1E2214EH

|         |  |  |
|---------|--|--|
| S0810L  |  |  |
| 1419-MD |  |  |

Fit&Go 1/3 Foam Inlay 3/8" Socket Set - 18 pcs Retail Pack



**FF1E2106EH**

55 x 185 x 480 mm 1 FF1E2106EH

|  |  |  |
|--|--|--|
| 7400SM-10, 7400SM-11, 7400SM-12, 7400SM-13, 7400SM-14, 7400SM-15, 7400SM-16, 7400SM-17, 7400SM-18, 7400SM-19, 7400SM-20, 7400SM-22 |  |  |
| 7760, 7761   |  |  |
| 7766   |  |  |
| SBS750   |  |  |
| 7402GPR-16, 7402GPR-21   |  |  |

Fit&Go 1/3 Foam Inlay 1/2" Socket Set - 21 pcs Retail Pack



**FF1E2215EH**

55 x 185 x 480 mm 1 FF1E2215EH

|  |  |  |
|--|--|--|
| 7800SM-10, 7800SM-11, 7800SM-12, 7800SM-13, 7800SM-14, 7800SM-15, 7800SM-16, 7800SM-17, 7800SM-18, 7800SM-19, 7800SM-20, 7800SM-21, 7800SM-22, 7800SM-23, 7800SM-24, 7800SM-27, 7800SM-30, 7800SM-32 |  |  |
| 8150SL   |  |  |
| 8174A  |  |  |
| 8166   |  |  |

Fit&Go 1/3 Foam Inlay 3/8" Deep Socket Set - 14 pcs Retail Pack



**FF1E2107EH**

55 x 185 x 480 mm 1 FF1E2107EH

|        |  |  |
|--------|--|--|
| S1214L |  |  |
|--------|--|--|

Fit&Go 1/3 Foam Inlay 1/2" Deep Socket Set - 12 pcs Retail Pack



**FF1E2503EH**

55 x 185 x 480 mm 1 FF1E2503EH

|        |  |  |
|--------|--|--|
| S1612L |  |  |
|--------|--|--|

Fit&Go 1/3 Foam Inlay Bit Set - 49 pcs Retail Pack



**BE5049**

55 x 185 x 480 mm 1 BE5049

|        |  |  |
|--------|--|--|
| BE5049 |  |  |
|--------|--|--|

Fit&Go 1/3 Foam Inlay Combination Spanners Set - 11 pcs Retail Pack



**FF1E3009EH**

55 x 185 x 480 mm 1 FF1E3009EH

|  |  |  |
|--|--|--|
| 111M-8, 111M-10, 111M-11, 111M-12, 111M-13, 111M-14, 111M-15, 111M-16, 111M-17, 111M-18, 111M-19 |  |  |
|--|--|--|



Fit&Go 1/3 Foam Inlay 1RM Ratcheting Spanners Set - 5 pcs Retail Pack



**FF1E3010EH**

55 x 185 x 480 mm 1 FF1E3010EH

- 1RM-8, 1RM-10, 1RM-13, 1RM-17, 1RM-19

Fit&Go 1/3 Foam Inlay Magnetic Dish & Adjustable Spanners Set - 4 pcs Retail Pack



**FF1E3011EH**

55 x 185 x 480 mm 1 FF1E3011EH

- 8070 IP, 8071 IP, 8072 IP
- 1419-MD

Fit&Go 1/3 Foam Inlay Pliers Set - 3 pcs Retail Pack



**FF1E4003EH**

55 x 185 x 480 mm 1 FF1E4003EH

- 8224 IP
- 2101G-160IP
- 2430 G-160 IP

Fit&Go 1/3 Foam Inlay Rivet Gun & Metal Shears Set - 4 pcs Retail Pack



**FF1E4004EH**

55 x 185 x 480 mm 1 FF1E4004EH

- 2681
- MA401
- MA411
- 1178-SCRIBE

Fit&Go 1/3 Foam Inlay Hammer, Pin Punches & Impact Driver Set - 23 pcs Retail Pack



**FF1E5010EH**

55 x 185 x 480 mm 1 FF1E5010EH

- 481-400
- 3734-2, 3734-3, 3734-4, 3734-5, 3734-6, 3734-8
- 3735-5-120
- 7865

Fit&Go 1/3 Foam Inlay Circlip Pliers Set - 4 pcs Retail Pack



**FF1E4005EH**

55 x 185 x 480 mm 1 FF1E4005EH

- 2800-150, 2800-180
- 2900-150, 2900-180

Fit&Go 1/3 Foam Inlay Awls, Hooks & Knives - 11 pcs Retail Pack



**FF1E5011EH**

55 x 185 x 480 mm 1 FF1E5011EH

- 2633/S4, 2633L/S4
- 2489
- 2485
- KE18-01

Fit&Go 1/3 Foam Inlay L-Keys, Bit Set & Magnetic Dish - 36 pcs Retail Pack



**FF1E5013EH**

55 x 185 x 480 mm 1 FF1E5013EH

- BE-9770
- 2058/S26
- 1419-MD

Fit&Go 1/3 Foam Inlay 1/4" Socket Set - 25 pcs Retail Pack



**FF1E2011EH**

55 x 185 x 480 mm 1 FF1E2011EH

- SL25





Fit&Go 1/3 Foam Inlay 1/2" Ratchet & Accessories Set - 24 pcs Retail Pack



**FF1E2216EH**

55 x 185 x 480 mm 1 FF1E2216EH

SBS81 S240NB-NR

Fit&Go 1/3 Foam Inlay 1/4" & 3/8" Socket Set - 33 pcs Retail Pack



**FF1E2504EH**

55 x 185 x 480 mm 1 FF1E2504EH

S330

Fit&Go 1/3 Foam Inlay 1/4" & 3/8" Socket Set - 34 pcs Retail Pack



**FF1E2505EH**

55 x 185 x 480 mm 1 FF1E2505EH

S330AF

Fit&Go 1/3 Foam Inlay Adjustable Spanner, Slip Joint Pliers & Metal Cutting Set - 8 pcs Retail Pack



**FF1E5014EH**

55 x 185 x 480 mm 1 FF1E5014EH

9031P 8224 208 3906-300-24-5P

1/3 Empty Foam with Cavities and Hanger



**FF1E5016EH**

35 x 181 x 445 mm 1 FF1E5016EH

Fit&Go 1/3 Foam Inlay ERGO™ Files Set - 4 pcs Retail Pack



**FF1E5015EH**

55 x 185 x 480 mm 1 FF1E5015EH

1-100-08-2-2 1-210-08-2-2 4-138-08-1-2 4-272-05-3-2

**RIGID CASES**

Heavy Duty Rigid Case General Purpose Toolkit - 162 Pcs



**4750RCWD4FF1**

453 x 340 x 575 mm 1 4750RCWD4FF1

- 4750RCWD4
- 6700SM-10, 6700SM-9, 6700SM-12, 6700SM-11, 6700SM-6, 6700SM-8, 6700SM-7, 6700SM-13
- A6800DM-13, A6800DM-12, A6800DM-9, A6800DM-8, A6800DM-11, A6800DM-10, A6800DM-5.5, A6800DM-7, A6800DM-6
- 6709M-3, 6709M-8, 6709M-6, 6709M-5, 6709M-4
- 6709PH-1, 6709PH-3, 6709PH-2
- 6709TORX-T30, 6709TORX-T27, 6709TORX-T40, 6709TORX-T15, 6709TORX-T10, 6709TORX-T25, 6709TORX-T20, 6709TORX-T9, 6709TORX-T8
- 6950SL
- 6954
- 6956
- 6958
- 6960, 6962, 6962L
- 6966
- 6972H
- 7764
- 7800SM-25, 7800SM-24, 7800SM-27, 7800SM-26, 7800SM-21, 7800SM-23, 7800SM-22, 7800SM-17, 7800SM-16, 7800SM-19, 7800SM-18, 7800SM-13, 7800SM-12, 7800SM-15, 7800SM-14, 7800SM-9, 7800SM-8, 7800SM-11, 7800SM-10, 7800SM-28, 7800SM-32, 7800SM-30
- 7809TORX-T45, 7809TORX-T25, 7809TORX-T50, 7809TORX-T30, 7809TORX-T27, 7809TORX-T40
- 8150RN-1/2
- 111M-30, 111M-32, 111M-27, 111M-29, 111M-24, 111M-19, 111M-18, 111M-21, 111M-15, 111M-14, 111M-17, 111M-16, 111M-11, 111M-10, 111M-13, 111M-12, 111M-7, 111M-6, 111M-9, 111M-8
- 9070C
- BE-9770

|                         |  |
|-------------------------|--|
| 2058-BR                 |  |
| 1544                    |  |
| MTB-3-16                |  |
| 2101G-160IP             |  |
| 2427 G-200 IP           |  |
| 2430 G-200 IP           |  |
| 2628 G-160IP            |  |
| 8224 IP                 |  |
| 1150-1/2H/P             |  |
| 5515T-52                |  |
| 2820EF2                 |  |
| 481-300                 |  |
| 3625W-35                |  |
| 3734-3, 3734-5, 3734-8  |  |
| 3735-4-120              |  |
| 1177-SCRIBE             |  |
| BFLA01                  |  |
| 8160-3, 8160-5, 8160-10 |  |
| 8166                    |  |
| 8157-15                 |  |
| 8154-11                 |  |

Heavy Duty Rigid Case Insulated Tool Kit - 79 pcs



**4750RCHDW02RF1V**

290 x 480 x 630 mm 1 4750RCHDW02RF1V

|   |  |
|---|--|
| 4750RCHDW02RED  |  |
| 8150-1/2V   |  |
| BMMTRMS1  |  |
| 28MV-10, 28MV-15, 28MV-16, 28MV-21, 28MV-22, 28MV-12, 28MV-13 |  |
| 2101S-160, 2101S-180  |  |
| 2101S-200   |  |
| 2223 S-150  |  |
| 2820VDE   |  |
| BE-8040S, BE-8050S, BE-8010S, BE-8065S                        |  |
| BE-8703S, BE-8704S, BE-8725S, BE-8705S, BE-8706S, BE-8708S    |  |

|   |  |
|---|--|
| BE-8910S, BE-8915S, BE-8920S, BE-8925S, BE-8930S  |  |
| SC127V  |  |
| 1999MV-5, 1999MV-6, 1999MV-7, 1999MV-8, 1999MV-9, 1999MV-10, 1999MV-12  |  |
| 2430V-160, 2430V-200  |  |
| 2678V-180, 2678V-160, 2678V-200   |  |
| 3416 A  |  |
| 806-1-1   |  |
| BE-8600S, BE-8610S, BE-8620S, BE-8630S, BE-8640S  |  |
| 527V-160  |  |
| 2427V-200   |  |
| 2MV-10, 2MV-11, 2MV-12, 2MV-13, 2MV-14, 2MV-15, 2MV-16, 2MV-17, 2MV-18, 2MV-19  |  |
| WR1-MM  |  |
| 7800DMV-8, 7800DMV-10, 7800DMV-11, 7800DMV-12, 7800DMV-13, 7800DMV-14, 7800DMV-15, 7800DMV-16, 7800DMV-17, 7800DMV-18, 7800DMV-19, 7800DMV-20, 7800DMV-21, 7800DMV-22 |  |
| 2820VPC   |  |
| 8162-1/2V   |  |
| 7224S   |  |

Heavy Duty Rigid Case MRO Toolkit - 195 Pcs



**4750RCHDW02FF1**

275 x 460 x 600 mm 1 4750RCHDW02FF1

|  |  |
|--|--|
| 4750RCHDW02  |  |
| 6700SM-12, 6700SM-13, 6700SM-10, 6700SM-11, 6700SM-8, 6700SM-9, 6700SM-6, 6700SM-7, 6700SM-5.5                             |  |
| A6800DM-13, A6800DM-11, A6800DM-12, A6800DM-9, A6800DM-10, A6800DM-7, A6800DM-8, A6800DM-5.5, A6800DM-6                    |  |
| 6709M-3, 6709M-4, 6709M-8, 6709M-5, 6709M-6  |  |
| 6709PH-1, 6709PH-2, 6709PH-3   |  |
| 6709TORX-T8, 6709TORX-T30, 6709TORX-T40, 6709TORX-T25, 6709TORX-T27, 6709TORX-T15, 6709TORX-T20, 6709TORX-T9, 6709TORX-T10 |  |

|  |  |
|--|--|
| 6950SL   |  |
| 6954   |  |
| 6956   |  |
| 6958   |  |
| 6960, 6962, 6962L  |  |
| 6966   |  |
| 6972H  |  |
| 7764   |  |
| 7800SM-13, 7800SM-14, 7800SM-11, 7800SM-12, 7800SM-9, 7800SM-10, 7800SM-8, 7800SM-32, 7800SM-30, 7800SM-27, 7800SM-28, 7800SM-25, 7800SM-26, 7800SM-23, 7800SM-24, 7800SM-21, 7800SM-22, 7800SM-19, 7800SM-17, 7800SM-18, 7800SM-15, 7800SM-16 |  |
| 7805SM-22, 7805SM-23, 7805SM-21, 7805SM-18, 7805SM-19, 7805SM-16, 7805SM-17, 7805SM-14, 7805SM-15, 7805SM-12, 7805SM-13, 7805SM-10, 7805SM-32, 7805SM-30, 7805SM-26, 7805SM-24, 7805SM-29, 7805SM-28, 7805SM-25, 7805SM-20                     |  |
| 7809TORX-T30, 7809TORX-T40, 7809TORX-T25, 7809TORX-T27, 7809TORX-T50, 7809TORX-T45   |  |
| 8150RN-1/2   |  |
| 111M-23, 111M-24, 111M-21, 111M-22, 111M-19, 111M-17, 111M-18, 111M-15, 111M-16, 111M-13, 111M-14, 111M-11, 111M-12, 111M-9, 111M-10, 111M-7, 111M-8, 111M-6, 111M-32, 111M-29, 111M-30, 111M-27, 111M-28, 111M-26, 111M-25                    |  |
| 1RM-18, 1RM-19, 1RM-16, 1RM-17, 1RM-14, 1RM-15, 1RM-12, 1RM-13, 1RM-10, 1RM-11, 1RM-8, 1RM-9, 1RM-6, 1RM-7   |  |
| 9070C  |  |
| BE-9770  |  |
| BE-8571  |  |
| 2058-BR  |  |
| 2509   |  |
| 1544   |  |
| 2101G-160IP  |  |
| 2427 G-200 IP  |  |
| 2430 G-200 IP  |  |
| 2628 G-160IP   |  |
| 8224 IP  |  |
| 1150-1/2H/P  |  |
| 5515T-52   |  |
| 2820EF2  |  |
| 481-300  |  |
| 3625W-35   |  |
| 3734-3, 3734-5, 3734-8   |  |
| 3735-4-120   |  |
| 1177-SCRIBE  |  |
| 2535F1   |  |
| BFLA01   |  |
| MTB-3-16   |  |
| 8160-3, 8160-5, 8160-10  |  |
| 8166   |  |
| 8154-11  |  |
| 8157-15  |  |



Heavy Duty Rigid Case Windpower Toolkit - 167 Pcs



**4750RCHDW02FF2**



480 x 290 x 630 mm



1 4750RCHDW02FF2

|  |  |  |
|--|--|--|
| 4750RCHDW02  |  |  |
| 6700SM-12, 6700SM-13, 6700SM-10, 6700SM-11, 6700SM-8, 6700SM-9, 6700SM-6, 6700SM-7, 6700SM-5.5   |  |  |
| 6954   |  |  |
| 6956   |  |  |
| 6958   |  |  |
| 6960, 6961, 6962, 6962L  |  |  |
| 6966   |  |  |
| 6972H  |  |  |
| 6950SL   |  |  |
| 7800SM-13, 7800SM-14, 7800SM-11, 7800SM-12, 7800SM-10, 7800SM-32, 7800SM-30, 7800SM-27, 7800SM-24, 7800SM-21, 7800SM-19, 7800SM-17, 7800SM-18, 7800SM-15, 7800SM-16, 7800SM-22 |  |  |
| 7809M-7, 7809M-6, 7809M-17, 7809M-19, 7809M-5, 7809M-14, 7809M-12, 7809M-10, 7809M-8   |  |  |
| 7809TORX-T60, 7809TORX-T40, 7809TORX-T55, 7809TORX-T50, 7809TORX-T45   |  |  |
| 59S/31-1   |  |  |
| 8150SL   |  |  |
| 111M-24, 111M-21, 111M-19, 111M-17, 111M-18, 111M-15, 111M-16, 111M-13, 111M-14, 111M-11, 111M-12, 111M-9, 111M-10, 111M-7, 111M-8, 111M-6, 111M-32, 111M-29, 111M-30, 111M-27 |  |  |
| BE-9770  |  |  |
| 1177-SCRIBE  |  |  |

|  |  |
|--|--|
| 6M-6-7, 6M-8-9, 6M-10-11, 6M-12-13, 6M-14-15, 6M-16-17, 6M-18-19, 6M-20-22, 6M-24-27, 6M-30-32 |  |
| MTB-3-16-E   |  |
| 9070, 9072   |  |
| 2535L  |  |
| BE-8020L, BE-8030  |  |
| BE-8155  |  |
| BE-8260  |  |
| BE-8610, BE-8620   |  |
| BE-8630  |  |
| BE-8810, BE-8820   |  |
| BE-8830  |  |
| 1544   |  |
| 2047-0.8-4   |  |
| TAH2047PR-1-2  |  |
| 2058-BR  |  |
| 2509   |  |
| 808050P  |  |
| 808050S  |  |
| BE-8220S, BE-8040S, BE-8050S   |  |
| BE-8610S, BE-8620S   |  |
| 2535F2   |  |
| 1150-1/2H/P  |  |
| 2101G-160IP  |  |
| 2427 G-200 IP  |  |
| 2430 G-200 IP  |  |
| 2628 G-160IP   |  |
| 2820EF2  |  |
| 5515T-52   |  |
| 8224 IP  |  |
| BFLA01   |  |
| 3625W-35   |  |
| 3734-3, 3734-5, 3734-8   |  |
| 3735-4-120   |  |
| 481-300  |  |
| 3680   |  |
| 3875-RL1   |  |
| 3875-WL1   |  |
| 4750-3PB-2   |  |
| 3750   |  |
| 8157-15  |  |
| 8154-11  |  |
| 8160-5, 8160-10  |  |
| 8171   |  |
| 8166   |  |

Heavy Duty Rigid Case Windmills Standard Application Toolkit - 114 Pcs



**4750RCHDW02FF4**



480 x 290 x 630 mm



1 4750RCHDW02FF4

|                                       |  |
|---------------------------------------|--|
| TAH9070, TAH9072                      |  |
| TAH3625W-35                           |  |
| TAH481-300                            |  |
| TAHBE-9777B                           |  |
| TAH2820EF2                            |  |
| TAH1150-1/2H/P                        |  |
| TAH1177-SCRIBE                        |  |
| TAH1544                               |  |
| TAH2509                               |  |
| TAH2535F2                             |  |
| MTS-5-25                              |  |
| TAHPINRELEASER                        |  |
| TAH2427G-200                          |  |
| TAH2430G-200                          |  |
| TAH2628G-160                          |  |
| TAH8224                               |  |
| TAH2484-30                            |  |
| TAH3734BM-3, TAH3734BM-8, TAH3734BM-5 |  |
| TAH3755BM-4                           |  |
| TAHSCB140G                            |  |
| TAHBE-8030, TAHBE-8020L               |  |
| TAHBE-8040S, TAHBE-8050S, TAHBE-8220S |  |
| TAHBE-8155                            |  |
| TAHBE-8260                            |  |
| TAHBE-8620S, TAHBE-8610S              |  |
| TAHBE-8620, TAHBE-8610                |  |
| TAHBE-8630                            |  |
| TAHBE-8810, TAHBE-8820                |  |
| TAHBE-8830                            |  |



|  |  |  |
|--|--|--|
| TAH08-5.5, TAH08-9, TAH08-7, TAH08-8, TAH08-13, TAH08-6, TAH08-11, TAH08-10, TAH08-12  |  |  |
| TAH6961, TAH6962, TAH6960, TAH6962L  |  |  |
| TAH6956-1  |  |  |
| TAH6950  |  |  |
| TAH6966  |  |  |
| TAH6958B-1   |  |  |
| TAH16B-27, TAH16B-30, TAH16B-24, TAH16B-22, TAH16B-32, TAH16B-19, TAH16B-21, TAH16B-17, TAH16B-18, TAH16B-11, TAH16B-15, TAH16B-16, TAH16B-13, TAH16B-10, TAH16B-14, TAH16B-12   |  |  |
| TAH16-H8, TAH16-H6, TAH16-H7, TAH16-H5, TAH16-H17, TAH16-H19, TAH16-H12, TAH16-H14, TAH16-H10  |  |  |
| TAH16-T40, TAH16-T45, TAH16-T50, TAH16-T55, TAH16-T60  |  |  |
| TAH8166  |  |  |
| TAH8150-1/2  |  |  |
| TAH8160, TAH8162   |  |  |
| TAH8158B-1   |  |  |
| TAH111M-32, TAH111M-27, TAH111M-24, TAH111M-21, TAH111M-22, TAH111M-19, TAH111M-9, TAH111M-7, TAH111M-8, TAH111M-18, TAH111M-6, TAH111M-16, TAH111M-17, TAH111M-14, TAH111M-15, TAH111M-12, TAH111M-13, TAH111M-10, TAH111M-11, TAH111M-30 |  |  |
| TAH2101G-160   |  |  |
| TAH2047PR-1-2  |  |  |
| TAH2047-0.8-4  |  |  |
| 4750RCHDW02  |  |  |

Heavy Duty Rigid Case Windmills Heavy Duty Application Toolkit - 36 Pcs



**4750RCHDW02FF15**

480 x 290 x 630 mm 1 4750RCHDW02FF15

|                 |  |  |
|-----------------|--|--|
| TAH1-100-06-2-4 |  |  |
| TAH1-210-06-2-2 |  |  |
| TAH1-230-06-2-2 |  |  |

|  |  |  |
|--|--|--|
| TAH3625PU-50   |  |  |
| TAH489-1100  |  |  |
| TAHBE64520   |  |  |
| TAHPINRELEASER   |  |  |
| TAHSCB140G   |  |  |
| TAH24B-50, TAH24B-46, TAH24B-41, TAH24B-38, TAH24B-36, TAH24B-32, TAH24B-30, TAH24B-27 |  |  |
| TAH8950N/A   |  |  |
| TAH8961  |  |  |
| TAH8953  |  |  |
| TAH7452-2  |  |  |
| TAH7435-100  |  |  |
| TAH111M-50, TAH111M-46, TAH111M-41, TAH111M-36, TAH111M-34                             |  |  |
| TAH7444SG-M-46, TAH7444SG-M-41, TAH7444SG-M-36, TAH7444SG-M-55, TAH7444SG-M-50         |  |  |
| 4750RCHDW02  |  |  |
| TAH73R-300   |  |  |

Heavy Duty Rigid Case Aviation Toolkit - 240 Pcs



**4750RCHDW01FF1**

250 x 345 x 545 mm 1 4750RCHDW01FF1

|             |  |  |
|-------------|--|--|
| 4750RCHDW01 |  |  |
| FF2B01      |  |  |
| FF2B02      |  |  |
| FF2B03      |  |  |
| FF2B04      |  |  |
| FF2B05      |  |  |
| FF2B06      |  |  |

Heavy Duty Rigid Case Aviation Toolkit - 159 Pcs



**4750RCHDW01FF2**

250 x 345 x 545 mm 1 4750RCHDW01FF2

|             |  |  |
|-------------|--|--|
| 4750RCHDW01 |  |  |
| FF2B07      |  |  |
| FF2B08      |  |  |
| FF2B09      |  |  |
| FF2B10      |  |  |
| FF2B11      |  |  |

Heavy Duty Rigid Case General Purpose Toolkit - 194 Pcs



**4750RCHDW01FF3**

250 x 345 x 545 mm 1 4750RCHDW01FF3

|             |  |  |
|-------------|--|--|
| 4750RCHDW01 |  |  |
| FF2B12      |  |  |
| FF2B13      |  |  |
| FF2B14      |  |  |
| FF2B15      |  |  |
| FF2B16      |  |  |



Heavy Duty Rigid Case Offshore Oil and Gas Crane Maintenance Application Toolkit - 29 Pcs



**4750RCHDW01FF4**



250 x 345 x 545 mm

1 4750RCHDW01FF4

|                         |  |  |
|-------------------------|--|--|
| TAH8075                 |  |  |
| TAH479-32               |  |  |
| TAHBE-9777B             |  |  |
| TAHBE-9787              |  |  |
| TAH2820EF2              |  |  |
| TAHBFRL11               |  |  |
| TAH466-250              |  |  |
| TAHPINRELEASER          |  |  |
| TAH380-10               |  |  |
| TAH2101G-160            |  |  |
| TAH2628G-180            |  |  |
| TAH2855                 |  |  |
| TAH8224                 |  |  |
| TAHSCB140G              |  |  |
| TAHBE-8258              |  |  |
| TAHBE-8241, TAHBE-8252  |  |  |
| TAHBE-8620L, TAHBE-8620 |  |  |
| 4750RCHDW01             |  |  |
| 4750-HDLB-TAH           |  |  |
| 3875-LY9                |  |  |
| 3875-LY5                |  |  |
| 3875-RL2                |  |  |
| 3875-MHP4               |  |  |
| 3875-MHP6               |  |  |
| 3875-HB60               |  |  |
| 3875-LY60               |  |  |
| 3875-LY70               |  |  |

Heavy Duty Rigid Case Offshore Oil and Gas Training Application Toolkit - 41 Pcs



**4750RCHDW01FF9**



250 x 345 x 545 mm

1 4750RCHDW01FF9

|                 |  |  |
|-----------------|--|--|
| TAH8073         |  |  |
| TAH84-PODGER    |  |  |
| TAH3640-250-C   |  |  |
| TAH1-143-12-1-2 |  |  |
| TAH479-32       |  |  |
| TAH325          |  |  |
| TAHBE-9777B     |  |  |
| TAH2820EF2      |  |  |
| TAHBFRL11       |  |  |
| TAHPINRELEASER  |  |  |
| TAH380-14       |  |  |
| TAH2101G-140    |  |  |
| TAH2628G-180    |  |  |
| TAH2855         |  |  |
| TAH2958-250     |  |  |
| TAH2484-30      |  |  |
| TAH3734BM-8     |  |  |
| TAHSCB140G      |  |  |
| TAHBE-8257      |  |  |
| TAHBE-8602      |  |  |
| TAH16B-19       |  |  |
| TAH16B-11/16    |  |  |
| TAH16-H8        |  |  |
| TAH8150-1/2     |  |  |
| TAH8158B-1      |  |  |
| TAH1949M-14-17  |  |  |
| 4750RCHDW01     |  |  |
| 4750-HDLB-TAH   |  |  |
| 3875-LY9        |  |  |
| 3875-LY5        |  |  |
| 3875-RL2        |  |  |
| 3875-MHP4       |  |  |
| 3875-MHP6       |  |  |
| 3875-HB60       |  |  |
| 3875-LY60       |  |  |
| 3875-LY70       |  |  |
| MTS-5-25        |  |  |

4750-MTHO-TAH

3875-HB60

TAH2487

TAH466-250

3875-LY60

3875-LY70

TAH73R-300



Aviation Toolkit - 159 Pcs/Rigid Case



**4750RCHD01FF1**



215 x 410 x 475 mm

1 4750RCHD01FF1

4750RCHD01

FF2A07

FF2A08

FF2A10

FF2A09



Aluminium Tool Box General Purpose Toolkit, 145pcs



**4750ALC01FF1**



160 x 320 x 450 mm

1 4750ALC01FF1

111M-14, 111M-15, 111M-16, 111M-17, 111M-18, 111M-19, 111M-8, 111M-9, 111M-10, 111M-11, 111M-12, 111M-13





|  |  |
|--|--|
| BE-9678  |  |
| 8072 C IP  |  |
| 224 D  |  |
| 2171G-160  |  |
| 2339-220IP   |  |
| 2678 G-180   |  |
| 2470 G-160   |  |
| SCB140   |  |
| B191.030.075, B191.040.125   |  |
| B190.055.125, B190.065.150   |  |
| B192.001.100, B192.002.125   |  |
| 806-1-1  |  |
| 482F-30  |  |
| MTB-5-25   |  |
| 208  |  |
| KB18-01  |  |
| 808050TS   |  |
| 59S/0.6-4.5-3P, 59S/1.0-5.5-3P, 59S/1.2-6.5-3P   |  |
| 59S/PH1-3P, 59S/PH2-3P, 59S/PH3-3P, 59S/PH0-3P   |  |
| 59S/PH2G-3P  |  |
| 59S/PZ2-3P, 59S/PZ3-3P, 59S/PZ0-3P, 59S/PZ1-3P   |  |
| 66IM/T20C-2P, 66IM/T15C-2P, 66IM/T10C-2P, 66IM/T40C-2P, 66IM/T30C-2P, 66IM/T27C-2P, 66IM/T25C-2P   |  |
| 59S/H1.5-3P, 59S/H3-3P, 59S/H2.5-3P, 59S/H4-3P, 59S/H5-3P, 59S/H2-3P, 59S/H6-3P, 59S/H8-3P   |  |
| KM6750-11, KM6750-6, KM6750-7, KM6750-8  |  |
| KM6750-10, KM6750-13, K6650-1/4-1P   |  |
| KM653-1P   |  |
| KSBG18-10DISPEN  |  |
| 700-1.5-50, 700-1.2-50, 700-1-50, 700-1.8-50   |  |
| 701-00-50, 701-0-50  |  |
| 3906-250-24-5P, 3906-250-32-5P   |  |
| 3735N-4-120  |  |
| 3734N-2-150, 3734N-4-150, 3734N-6-150  |  |
| SBS60-9, SBS60-10, SBS60-11, SBS60-12, SBS60-13, SBS60-4, SBS60-4.5, SBS60-5, SBS60-5.5, SBS60-6, SBS60-7, SBS60-8   |  |
| SBS61  |  |
| SB6963   |  |
| SBS64  |  |
| 6960-3   |  |
| 8160-10, 8160-5  |  |
| 8158-10  |  |
| 7800SM-20, 7800SM-21, 7800SM-22, 7800SM-23, 7800SM-24, 7800SM-27, 7800SM-12, 7800SM-13, 7800SM-14, 7800SM-15, 7800SM-16, 7800SM-17, 7800SM-18, 7800SM-19, 7800SM-10, 7800SM-11, 7800SM-30, 7800SM-32 |  |
| SBS81  |  |
| 8166   |  |
| 7772H  |  |

### Wheeled Rigid Case General Purpose Toolkit - 32 Pcs



#### 984010320



255 x 390 x 465 mm

1 984010320

4750RCW01

2101D-160IP

224 D

2630D-180

2430 D-160 IP

6M/8C

8071 C IP

483-20

541D-180

2951-180

B191.030.075, B191.040.100

B190.100.200, B190.065.150

B192.001.100, B192.002.125

SC127

2820EF2

BE-9777

MTB-3-16

### Rigid Case General Purpose Toolkit - 32 Pcs



#### 983100320



210 x 415 x 460 mm

1 983100320

4750RC02

2101D-160IP

224 D

2430 D-160 IP

8071 C IP

483-20

541D-180

2951-180

B191.030.075, B191.040.100

B190.100.200, B190.065.150

B192.001.100, B192.002.125

SC127

2820EF2

BE-9777

MTB-3-16

2630DC-180IP

6M/8C

### Plastic Case General Purpose Toolkit - 32 Pcs



#### 983000320



162 x 380 x 435 mm

1 983000320

4750RC01

2101D-160IP

224 D

2630D-180

2430 D-160 IP

8071 C IP

483-20

541D-180

2951-180

6M/8C

B191.030.075, B191.040.100

B190.100.200, B190.065.125

B192.001.100, B192.002.125

SC127

2820EF2

BE-9777

MTB-3-16



Rigid Case General Purpose Toolkit - 109 Pcs



|  |  |
|--|--|
| 1995LM-1.5, 1995LM-2, 1995LM-2.5, 1995LM-3, 1995LM-4 |  |
| 1997M/10T  |  |
| 2047-0.8-4, 2047-1-5.5                               |  |
| 2421 D-140IP   |  |
| 2430 GC-200 IP                                       |  |
| 2530-40  |  |
| 2744   |  |
| 4750RC021  |  |
| 7372I-2.5-75   |  |
| 8070 C   |  |
| 2223 S-150   |  |

150 L Wheeled Rigid Tool Cases with Telescopic Handle and 4 Drawers



4750RCWD4

|                    |   |              |
|--------------------|---|--------------|
|                    |   |              |
| 453 x 340 x 575 mm | 1 | 4750RCWD4    |
| 453 x 340 x 575 mm | 1 | 4750RCWD4-OR |

153.9 L Wheeled Heavy Duty Rigid Cases



4750RCHDW10

|                    |   |             |
|--------------------|---|-------------|
|                    |   |             |
| 460 x 560 x 860 mm | 1 | 4750RCHDW10 |

53 L Wheeled Heavy Duty Rigid Cases



4750RCHDW02

|                    |   |                |
|--------------------|---|----------------|
|                    |   |                |
| 290 x 480 x 630 mm | 1 | 4750RCHDW02    |
| 290 x 480 x 630 mm | 1 | 4750RCHDW02RED |

60x37mm wheels on ball bearings

31 L Wheeled Heavy Duty Rigid Cases



4750RCHDW01

|                    |   |                |
|--------------------|---|----------------|
|                    |   |                |
| 240 x 350 x 545 mm | 1 | 4750RCHDW01    |
| 240 x 350 x 545 mm | 1 | 4750RCHDW01RED |

60x20 wheels on ball bearing for easy transport even when very loaded

29 L Heavy Duty Rigid Cases



4750RCHD01

|                    |   |            |
|--------------------|---|------------|
|                    |   |            |
| 215 x 415 x 465 mm | 1 | 4750RCHD01 |

Indestructible tool case with injected copolymer polypropylene structural resin

2010

|     |                    |        |
|-----|--------------------|--------|
|     |                    |        |
| 109 | 480 x 180 x 330 mm | 1 2010 |

|  |  |
|--|--|
| 1952M-6, 1952M-7, 1952M-8, 1952M-9, 1952M-10, 1952M-11, 1952M-12, 1952M-13, 1952M-14 |  |
| 4020L-M-3, 4020L-M-3.2, 4020L-M-3.5, 4020L-M-4, 4020L-M-4.5, 4020L-M-5.5             |  |
| BE-8340, BE-8350, BE-8355  |  |
| 700-1.5-50, 700-1.2-50, 700-1-50, 700-1.8-50   |  |
| 3659/8T  |  |
| 5550-3.2, 5550-4.5   |  |
| BE-8220S, BE-8050S, BE-8255S   |  |
| 5516 I   |  |
| 5577-145   |  |
| 5418   |  |
| 2535L  |  |
| 3524   |  |
| 2648   |  |
| 1150-1/2H/P  |  |
| 1952Z-1/4, 1952Z-3/8, 1952Z-1/2  |  |
| BE-8620S   |  |
| BE-7845, BE-7806   |  |
| 701-0-50, 701-00-50  |  |
| 8045LVDE   |  |
| 5574-145   |  |
| 2-470-16-1-0x 6  |  |
| 5515GV   |  |
| 5423   |  |
| 2665 B-160   |  |
| 326000300  |  |
| 328000000  |  |
| 2656 R   |  |
| BE-3529  |  |
| BE-6400M-4, BE-6400M-5, BE-6400M-5.5, BE-6400M-7                                     |  |
| BE-8160  |  |
| BE-8600, BE-8610   |  |

29 L Heavy Duty Rigid Cases with Tool Pallets



**4750RCHD011**



215 x 415 x 465 mm

1 4750RCHD011

35 L Rigid Tool Cases



**4750RC02**



221 x 406 x 485 mm  
221 x 406 x 485 mm

1 4750RC02  
1 4750RC021

4750RC02: with transparent pouches on one side 4750RC021: With rubber strips on one side

Pivoting Under Lid Tool Pallets with Pouch System



**4750RCWD-AC2**



30 x 277 x 507 mm

1 4750RCWD-AC2

18.5 L Heavy Duty Rigid Cases



**4750RCHD00**



205 x 345 x 400 mm

1 4750RCHD00

23-35 L Rigid Tool Cases



**4750RC01**



165 x 399 x 450 mm

1 4750RC01

Pivoting Under Lid Tool Pallets with Fixed Elastics



**4750RCWD-AC3**



5 x 277 x 507 mm

1 4750RCWD-AC3

42 L Wheeled Rigid Tool Cases with Telescopic Handle



**4750RCW01**



257 x 406 x 485 mm  
257 x 406 x 485 mm

1 4750RCW01  
1 4750RCW011

4750RCW01 with transparent pouches.4750RCW011 with rubber strips on lid and bottom tool pallets

Swivelling Wheel Kit - 4 Pcs



**4750RCWD-AC1**



100 x 50 x 200 mm

1 4750RCWD-AC1

Fixed Under Lid Tool Pallets with Adjustable Elastics



**4750RCWD-AC4**



4 x 286 x 490 mm

1 4750RCWD-AC4



Removable Padded Lid Panels for 4750RCHD01



**4750RCHD01AC1**



35 x 305 x 425 mm



1 4750RCHD01AC1

Internal Bags for 4750RCHDW01 Heavy Duty Rigid Case



**4750RCHDW01AC2**



120 x 280 x 525 mm



1 4750RCHDW01AC2

Removable Padded Bags for 4750RCHD01 Heavy Duty Rigid Case



**4750RCHD01AC2**



135 x 360 x 450 mm



1 4750RCHD01AC2

TSA Locks for 4750RCHD Cases



**4750RCHD-AC1**



20 x 40 x 70 mm



1 4750RCHD-AC1

Removable Lid Panels for 4750RCHDW01 Heavy Duty Case



**4750RCHDW01AC1**



50 x 204 x 500 mm



1 4750RCHDW01AC1

Foam Inlay Socket Set for 4750RCHD01 Heavy Duty Rigid Case - 64 Pcs



**FF2A07**



45 x 330 x 430 mm



1 FF2A07

|  |  |
|--|--|
| A6710DZ-3/8, A6710DZ-5/16, A6710DZ-7/16, A6710DZ-1/4   |  |
| A6800DZ-1/2, A6800DZ-1/4, A6800DZ-11/32, A6800DZ-3/16, A6800DZ-3/8, A6800DZ-5/16, A6800DZ-7/16, A6800DZ-7/32, A6800DZ-9/16, A6800DZ-9/32 |  |
| A7400DZ-1/2, A7400DZ-11/16, A7400DZ-13/16, A7400DZ-19/32, A7400DZ-3/4, A7400DZ-3/8, A7400DZ-5/8, A7400DZ-7/16, A7400DZ-7/8, A7400DZ-9/16 |  |
| A7402DZ-1/2, A7402DZ-11/16, A7402DZ-13/16, A7402DZ-19/32, A7402DZ-3/4, A7402DZ-3/8, A7402DZ-5/8, A7402DZ-7/16, A7402DZ-7/8, A7402DZ-9/16 |  |
| 2058-BR  |  |
| 6950SL   |  |
| 6954   |  |
| 6956   |  |
| 6960, 6962, 6962L  |  |
| 6966   |  |
| 6972H  |  |
| 7407H, 7408H   |  |
| 7750SL   |  |
| 7752   |  |
| 7760, 7761, 7762   |  |
| 7764   |  |
| 7765   |  |
| 7766   |  |
| 8164-1/2   |  |

Foam Inlay Wrench and File Set for 4750RCHD01 Heavy Duty Rigid Case - 24 Pcs



**FF2A08**



45 x 335 x 435 mm



1 FF2A08

|   |  |
|---|--|
| 1-100-04-2-2  |  |
| 1-230-04-2-2  |  |
| 111Z-1, 111Z-1/2, 111Z-1/4, 111Z-11/16, 111Z-3/4, 111Z-3/8, 111Z-5/16, 111Z-5/8, 111Z-7/16, 111Z-9/16, 111Z-7/8 |  |
| 1177-SCRIBE   |  |
| 1320RZ-1/2-9/16, 1320RZ-1/4-5/16, 1320RZ-3/8-7/16, 1320RZ-5/16-11/32  |  |
| 1931Z-1/4, 1931Z-3/16, 1931Z-7/32   |  |
| 1950MZ-3/8  |  |
| 208   |  |
| 9031 C  |  |



Foam Inlay Screwdriver and Wrench Set for 4750RCHD01 Heavy Duty Rigid Case - 56 Pcs



**FF2A09**



45 x 335 x 440 mm 1 FF2A09

|                           |  |  |
|---------------------------|--|--|
| BE-8040, BE-8210          |  |  |
| BE-8260                   |  |  |
| BE-8600, BE-8610, BE-8620 |  |  |
| BE-9780                   |  |  |
| MTB-3-16-E                |  |  |
| 2047-1-5.5                |  |  |
| 2047PR-1-2                |  |  |
| 59/S28-4                  |  |  |
| 2509                      |  |  |
| 2535F2                    |  |  |
| 5515T-52                  |  |  |
| 808050                    |  |  |
| 1179-FLX-2, BFLA01        |  |  |
| BE-8150                   |  |  |

Foam Inlay Toolset for Heavy Duty Rigid Cases - 15 Pcs



**FF2A10**



49 x 330 x 435 mm 1 FF2A10

|                                |  |
|--------------------------------|--|
| 2101GC-160IP                   |  |
| 2427 GC-200IP                  |  |
| 2628 GC-160IP                  |  |
| 2632                           |  |
| 2650                           |  |
| 2855                           |  |
| 2979 D-180                     |  |
| 3625N-32                       |  |
| 3734-2, 3734-3, 3734-4, 3734-5 |  |
| 3735-4-120                     |  |
| 481-300                        |  |
| 8224CIP                        |  |

Foam Inlay Socket Set for 4750RCHD01 Heavy Duty Rigid Case - 61 Pcs



**FF2B01**



40 x 270 x 505 mm 1 FF2B01

|  |  |
|--|--|
| A6700DZ-1/2, A6700DZ-1/4, A6700DZ-11/32, A6700DZ-3/16, A6700DZ-3/8, A6700DZ-5/16, A6700DZ-7/16, A6700DZ-7/32, A6700DZ-9/16, A6700DZ-9/32               |  |
| A6800DZ-1/2, A6800DZ-1/4, A6800DZ-11/32, A6800DZ-3/16, A6800DZ-3/8, A6800DZ-5/16, A6800DZ-7/16, A6800DZ-7/32, A6800DZ-9/16, A6800DZ-9/32               |  |
| A7400DZ-1/2, A7400DZ-1/4, A7400DZ-11/16, A7400DZ-17/32, A7400DZ-19/32, A7400DZ-3/4, A7400DZ-3/8, A7400DZ-5/16, A7400DZ-5/8, A7400DZ-7/16, A7400DZ-9/16 |  |
| A7402DZ-1/2, A7402DZ-1/4, A7402DZ-11/16, A7402DZ-19/32, A7402DZ-3/4, A7402DZ-3/8, A7402DZ-5/16, A7402DZ-5/8, A7402DZ-7/16, A7402DZ-9/16                |  |
| 6950SL   |  |
| 6954   |  |
| 6956   |  |
| 6958   |  |
| 6960, 6961, 6962L  |  |
| 6966   |  |
| 6972H  |  |
| 7407H  |  |
| 7750SL   |  |
| 7752   |  |
| 7760, 7761, 7762   |  |
| 7764   |  |
| 7765   |  |
| 7766   |  |
| 8164-1/2   |  |
| U-S6106KA  |  |

Foam Inlay Wrench and Socket Set for 4750RCHD01 Heavy Duty Rigid Case - 69 Pcs



**FF2B02**



39 x 270 x 505 mm 1 FF2B02

|  |  |
|--|--|
| A6700DM-5.5, A6700DM-6, A6700DM-11, A6700DM-12, A6700DM-13, A6700DM-14, A6700DM-7, A6700DM-8, A6700DM-9, A6700DM-10                        |  |
| A6800DM-6, A6800DM-7, A6800DM-8, A6800DM-9, A6800DM-4, A6800DM-5, A6800DM-5.5, A6800DM-14, A6800DM-10, A6800DM-11, A6800DM-12, A6800DM-13  |  |
| A7400DM-10, A7400DM-14, A7400DM-15, A7400DM-16, A7400DM-11, A7400DM-12, A7400DM-17, A7400DM-18, A7400DM-19, A7400DM-13                     |  |
| A7402DM-19, A7402DM-15, A7402DM-16, A7402DM-17, A7402DM-18, A7402DM-11, A7402DM-12, A7402DM-13, A7402DM-14, A7402DM-10                     |  |
| BE-9770  |  |
| 111M-24, 111M-6, 111M-7, 111M-12, 111M-13, 111M-14, 111M-15, 111M-8, 111M-9, 111M-10, 111M-11, 111M-22, 111M-16, 111M-17, 111M-18, 111M-19 |  |
| 4020L-M-5, 4020L-M-5.5   |  |

Foam Inlay Wrench and Socket Set for 4750RCHD01 Heavy Duty Rigid Case - 44 Pcs



**FF2B03**



35 x 270 x 505 mm 1 FF2B03

|  |  |
|--|--|
| A6710DM-7  |  |
| A6710DZ-1/2, A6710DZ-1/4, A6710DZ-11/32, A6710DZ-3/16, A6710DZ-3/8, A6710DZ-5/16, A6710DZ-7/16, A6710DZ-7/32, A6710DZ-9/16, A6710DZ-9/32 |  |
| BE-9780  |  |
| 111Z-1, 111Z-1/2, 111Z-1/4, 111Z-11/16, 111Z-3/4, 111Z-3/8, 111Z-5/16, 111Z-5/8, 111Z-7/16, 111Z-7/8, 111Z-9/16, 111Z-13/16              |  |
| 1320RZ-1/2-9/16, 1320RZ-1/4-5/16, 1320RZ-3/8-7/16, 1320RZ-5/16-11/32   |  |
| 1931Z-1/4, 1931Z-3/16, 1931Z-7/32  |  |
| 1950MZ-3/8   |  |
| 2058-BR  |  |





Foam Inlay Socket Set for 4750RCHDW01 Heavy Duty Rigid Case - 45 Pcs



**FF2B04**

|                   |   |        |
|-------------------|---|--------|
|                   |   |        |
| 42 x 270 x 505 mm | 1 | FF2B04 |

|                      |  |  |
|----------------------|--|--|
| BE-8020L, BE-8040    |  |  |
| BE-8080-10           |  |  |
| BE-8150, BE-8255     |  |  |
| BE-8610, BE-8620     |  |  |
| 1544                 |  |  |
| 2509                 |  |  |
| 59/S28-4             |  |  |
| 2535F2               |  |  |
| 5516                 |  |  |
| 700-1.5-50, 700-1-50 |  |  |
| 701-0-50, 701-00-50  |  |  |
| 808050               |  |  |
| 9070C                |  |  |

Foam Inlay Pliers Set for 4750RCHDW01 Heavy Duty Rigid Case - 15 Pcs



**FF2B05**

|                   |   |        |
|-------------------|---|--------|
|                   |   |        |
| 35 x 270 x 510 mm | 1 | FF2B05 |

|                            |  |  |
|----------------------------|--|--|
| 1150-1/2H/P                |  |  |
| MTB-3-16-M-E               |  |  |
| 2101GC-125IP, 2101GC-160IP |  |  |
| 2427 GC-200IP              |  |  |
| 2628 GC-160IP              |  |  |
| 2650                       |  |  |
| 2820EF2                    |  |  |
| 2855                       |  |  |
| 4130                       |  |  |
| 4830                       |  |  |
| 5515T-52                   |  |  |
| 8224CIP                    |  |  |
| BFLA01, 1179-FLX-2         |  |  |

Foam Inlay Hammer and Punch Set for 4750RCHDW01 Heavy Duty Rigid Case - 6 Pcs



**FF2B06**

|                   |   |        |
|-------------------|---|--------|
|                   |   |        |
| 35 x 122 x 355 mm | 1 | FF2B06 |

|                        |  |  |
|------------------------|--|--|
| 3625N-32               |  |  |
| 3734-5, 3734-8, 3734-3 |  |  |
| 3735-5-120             |  |  |
| 481-300                |  |  |

Foam Inlay Wrench and Socket Set for 4750RCHDW01 Heavy Duty Rigid Case - 62 Pcs



**FF2B07**

|                   |   |        |
|-------------------|---|--------|
|                   |   |        |
| 35 x 270 x 505 mm | 1 | FF2B07 |

|  |  |  |
|--|--|--|
| A6700DZ-1/2, A6700DZ-1/4, A6700DZ-11/32, A6700DZ-3/16, A6700DZ-3/8, A6700DZ-5/16, A6700DZ-7/16, A6700DZ-7/32, A6700DZ-9/16, A6700DZ-9/32 |  |  |
| A6710DZ-3/8, A6710DZ-5/16, A6710DZ-7/16  |  |  |
| A6800DZ-1/2, A6800DZ-1/4, A6800DZ-11/32, A6800DZ-3/16, A6800DZ-3/8, A6800DZ-5/16, A6800DZ-7/16, A6800DZ-7/32, A6800DZ-9/16, A6800DZ-9/32 |  |  |
| A7400DZ-1/2, A7400DZ-11/16, A7400DZ-13/16, A7400DZ-19/32, A7400DZ-3/4, A7400DZ-3/8, A7400DZ-5/8, A7400DZ-7/16, A7400DZ-7/8, A7400DZ-9/16 |  |  |
| A7402DZ-1/2, A7402DZ-11/16, A7402DZ-13/16, A7402DZ-19/32, A7402DZ-3/4, A7402DZ-3/8, A7402DZ-5/8, A7402DZ-7/16, A7402DZ-7/8, A7402DZ-9/16 |  |  |
| 6950SL   |  |  |
| 6954   |  |  |
| 6956   |  |  |
| 6960, 6962, 6962L  |  |  |
| 6966   |  |  |
| 6972H  |  |  |

|                  |  |  |
|------------------|--|--|
| 7407H, 7408H     |  |  |
| 7750SL           |  |  |
| 7752             |  |  |
| 7760, 7761, 7762 |  |  |
| 7764             |  |  |
| 7765             |  |  |
| 7766             |  |  |
| 8164-1/2         |  |  |

Foam Inlay Wrench Set for 4750RCHDW01 Heavy Duty Rigid Case - 25 Pcs



**FF2B08**

|                   |   |        |
|-------------------|---|--------|
|                   |   |        |
| 44 x 270 x 505 mm | 1 | FF2B08 |

|   |  |  |
|---|--|--|
| 1-100-04-2-2  |  |  |
| 1-230-04-2-2  |  |  |
| 111Z-1, 111Z-1/2, 111Z-1/4, 111Z-11/16, 111Z-3/4, 111Z-3/8, 111Z-5/16, 111Z-5/8, 111Z-7/16, 111Z-7/8, 111Z-9/16 |  |  |
| 1177-SCRIBE   |  |  |
| 1320RZ-1/2-9/16, 1320RZ-1/4-5/16, 1320RZ-3/8-7/16, 1320RZ-5/16-11/32  |  |  |
| 1931Z-1/4, 1931Z-3/16, 1931Z-7/32   |  |  |
| 1950MZ-3/8  |  |  |
| 2058-BR   |  |  |
| 208   |  |  |
| 9031 C  |  |  |

Foam Inlay Screwdriver Set for 4750RCHDW01 Heavy Duty Rigid Case - 56 Pcs



**FF2B09**

|                   |   |        |
|-------------------|---|--------|
|                   |   |        |
| 47 x 270 x 505 mm | 1 | FF2B09 |

|                           |  |  |
|---------------------------|--|--|
| BE-8040, BE-8210          |  |  |
| BE-8150                   |  |  |
| BE-8260                   |  |  |
| BE-8600, BE-8610, BE-8620 |  |  |
| BE-9780                   |  |  |

|                    |  |
|--------------------|--|
| MTB-3-16-E         |  |
| 2047-1-5.5         |  |
| 2047PR-1-2         |  |
| 2509               |  |
| 2535F2             |  |
| 5515T-52           |  |
| 59/S28-4           |  |
| BFLA01, 1179-FLX-2 |  |
| 808050             |  |

Foam Inlay Aviation Pliers Set for 4750RCHDW01 Heavy Duty Rigid Case - 9 Pcs



**FF2B10**

37 x 270 x 505 mm 1 FF2B10

|                |  |
|----------------|--|
| 2101GC-160IP   |  |
| 2427 GC-200IP  |  |
| 2430 GC-200 IP |  |
| 2628 GC-160IP  |  |
| 2650           |  |
| 2744           |  |
| 2855           |  |
| 2979 D-180     |  |
| 8224CIP        |  |

Foam Inlay Striking Toolset for 4750RCHDW01 Heavy Duty Rigid Case - 7 Pcs



**FF2B11**

39 x 122 x 355 mm 1 FF2B11

|                                |  |
|--------------------------------|--|
| 2632                           |  |
| 3625N-32                       |  |
| 3734-2, 3734-3, 3734-4, 3734-5 |  |
| 481-300                        |  |

Foam Inlay Socket Set for 4750RCHDW01 Heavy Duty Rigid Case - 92 Pcs



**FF2B12**

44 x 270 x 505 mm 1 FF2B12

A6800DM-6, A6800DM-7, A6800DM-8, A6800DM-9, A6800DM-5.5, A6800DM-10, A6800DM-11, A6800DM-12, A6800DM-13

A7402DM-19, A7402DM-15, A7402DM-16, A7402DM-17, A7402DM-18, A7402DM-11, A7402DM-12, A7402DM-13, A7402DM-14, A7402DM-10

6700SM-5.5, 6700SM-6, 6700SM-11, 6700SM-12, 6700SM-13, 6700SM-7, 6700SM-8, 6700SM-9, 6700SM-10

6709M-3, 6709M-4, 6709M-5, 6709M-6, 6709M-8

6709PH-1, 6709PH-2, 6709PH-3

6709TORX-T20, 6709TORX-T25, 6709TORX-T27, 6709TORX-T30, 6709TORX-T8, 6709TORX-T9, 6709TORX-T10, 6709TORX-T15, 6709TORX-T40

6954

6956

6958

6960, 6961, 6962, 6962L

6966

6972H

7400SM-6, 7400SM-11, 7400SM-12, 7400SM-13, 7400SM-14, 7400SM-7, 7400SM-8, 7400SM-9, 7400SM-10, 7400SM-19, 7400SM-22, 7400SM-15, 7400SM-16, 7400SM-17, 7400SM-18

7407H

7409M-8, 7409M-10, 7409M-4, 7409M-5, 7409M-6, 7409M-7, 7409M-3

7409TORX-T25, 7409TORX-T27, 7409TORX-T30, 7409TORX-T40, 7409TORX-T45, 7409TORX-T50

7750SL

7761, 7762, 7760

7764

7765

7766

8164-1/2

6950SL

Foam Inlay Wrench Set for 4750RCHDW01 Heavy Duty Rigid Case - 39 Pcs



**FF2B13**

50 x 270 x 505 mm 1 FF2B13

BE-9770

111M-12, 111M-13, 111M-14, 111M-15, 111M-8, 111M-9, 111M-10, 111M-11, 111M-6, 111M-7, 111M-21, 111M-22, 111M-16, 111M-17, 111M-18, 111M-19

6M-6-7, 6M-8-9, 6M-10-11, 6M-12-13, 6M-14-15, 6M-16-17, 6M-18-19, 6M-20-22

9070C

1177-SCRIBE

2535F2

BFLA01

7758

7754

Foam Inlay Screwdriver Set for 4750RCHDW01 Heavy Duty Rigid Case - 48 Pcs



**FF2B14**

35 x 270 x 505 mm 1 FF2B14

BE-8020L, BE-8030

BE-8155

BE-8260

BE-8350

BE-8601, BE-8602

BE-8610, BE-8620

BE-8630

1544

2047-0.8-4

2047PR-1-2

2058-BR

2509

808050P

808050S

59S/31-1



Foam Inlay General Purpose Pliers Set for 4750RCHDW01 Heavy Duty Rigid Case - 9 Pcs



**FF2B15**



35 x 270 x 505 mm

1 FF2B15

|                |  |
|----------------|--|
| 1150-1/2H/P    |  |
| 2101GC-160IP   |  |
| 2427 GC-200IP  |  |
| 2430 GC-200 IP |  |
| 2628 GC-160IP  |  |
| 2820EF2        |  |
| 5515T-52       |  |
| 8224CIP        |  |
| MTB-3-16-M-E   |  |

Foam Inlay Striking Set for 4750RCHDW01 Heavy Duty Rigid Case - 6 Pcs



**FF2B16**



34 x 122 x 355 mm

1 FF2B16

|                        |  |
|------------------------|--|
| 3625W-35               |  |
| 3734-3, 3734-5, 3734-8 |  |
| 3735-4-120             |  |
| 481-300                |  |

**CABINETS, PANELS & WORKBENCHES**

1800 mm Tool Cabinets with Shutter General Purpose Toolkit - 110 Pcs



**1495CS18TS1**



900 x 170 x 1800 mm

1 1495CS18TS1

|             |  |
|-------------|--|
| 1495CS18    |  |
| 981001100   |  |
| 1495CS-AC1  |  |
| 1495TP-AC10 |  |

1500 mm Tool Cabinets with Shutter General Purpose Toolkit - 110 Pcs



**1495CS15TS1**



900 x 170 x 1500 mm

1 1495CS15TS1

|             |  |
|-------------|--|
| 1495CS15    |  |
| 981001100   |  |
| 1495CS-AC1  |  |
| 1495TP-AC10 |  |

Tool Cabinets with 2 Doors General Purpose Toolkit - 110 Pcs



**1495CD60TS1**



900 x 250 x 602 mm

1 1495CD60TS1

|             |  |
|-------------|--|
| 1495CD60    |  |
| 981001100   |  |
| 1495CD-AC1  |  |
| 1495TP-AC10 |  |

Foam Inlay Metric Toolset for our metallic cases 1483K & 1483KHD Series - 12 Pcs



**FF3A11**



39 x 205 x 445 mm

1 FF3A11

|                        |  |
|------------------------|--|
| 1150-1/2H/P            |  |
| MTB-3-16               |  |
| 1177-SCRIBE            |  |
| 2101GC-160IP           |  |
| 2427 GC-200IP          |  |
| 2430 GC-200 IP         |  |
| 2628 GC-160IP          |  |
| 3734-3, 3734-5, 3734-8 |  |
| 3735-4-120             |  |
| 8224CIP                |  |



Foam Inlay Metric Toolset for our metallic cases 1483K & 1483KHD Series - 28 Pcs



### FF3A12



45 x 205 x 450 mm

1 FF3A12

111M-6, 111M-21, 111M-19, 111M-18,  
111M-22, 111M-13, 111M-12, 111M-11,  
111M-10, 111M-17, 111M-16, 111M-15,  
111M-14, 111M-9, 111M-8, 111M-7



2820EF2



5515T-52



6M-10-11, 6M-6-7, 6M-12-13, 6M-8-9,  
6M-14-15, 6M-16-17, 6M-18-19, 6M-  
20-22



BFLA01



9070C



Foam Inlay Metric Toolset for our metallic cases 1483K & 1483KHD Series - 49 Pcs



### FF3A13



68 x 245 x 525 mm

1 FF3A13

111M-27, 111M-32, 111M-24, 111M-30



6M-24-27, 6M-30-32



7800SM-19, 7800SM-18, 7800SM-17,  
7800SM-16, 7800SM-22, 7800SM-21,  
7800SM-11, 7800SM-10, 7800SM-15,  
7800SM-14, 7800SM-13, 7800SM-12,  
7800SM-27, 7800SM-32, 7800SM-30,  
7800SM-24



7807H



7809M-10, 7809M-12, 7809M-14,  
7809M-19, 7809M-17, 7809M-5, 7809M-  
8, 7809M-6, 7809M-7



7809TORX-T50, 7809TORX-T45,  
7809TORX-T60, 7809TORX-T55,  
7809TORX-T25, 7809TORX-T20,  
7809TORX-T40, 7809TORX-T30,  
7809TORX-T27



8150SL



8164-1/2



8154-11



8160-5, 8160-10



8171



8166



8172



Foam Inlay Imperial Toolset for our metallic cases 1483K & 1483KHD Series - 77 Pcs



### FF3A14



65 x 247 x 510 mm

1 FF3A14

A6700DZ-1/2, A6700DZ-1/4,  
A6700DZ-3/8, A6700DZ-5/16,  
A6700DZ-7/16, A6700DZ-7/32,  
A6700DZ-9/16, A6700DZ-9/32,  
A6700DZ-11/32

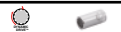

A6800DZ-1/4, A6800DZ-5/16,  
A6800DZ-7/32, A6800DZ-9/32



A7400DM-10, A7400DM-13



A7400DZ-1/2, A7400DZ-11/16,  
A7400DZ-13/16, A7400DZ-3/4,  
A7400DZ-5/8, A7400DZ-7/8,  
A7400DZ-9/16



A7402DZ-1/2, A7402DZ-3/8,  
A7402DZ-7/16, A7402DZ-9/16



111Z-1, 111Z-1.1/8



59/S28-4



6Z-1.1/16-1.1/4, 6Z-1-1.1/8



6Z/8C



6950SL



6958



6960, 6961



6966



6972H



7407H, 7408H



7750SL



7752



7760, 7761



7764



7765



7766

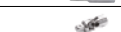

7800DZ-1, 7800DZ-15/16



8164-1/2



1952Z-15/16



8171

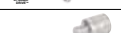

Foam Inlay Imperial Toolset for our metallic cases 1483K & 1483KHD Series - 14 Pcs



### FF3A15



40 x 210 x 445 mm

1 FF3A15

BE-3529



BE-8020L



BE-8155



BE-8260



BE-8601, BE-8602



BE-8611, BE-8621



1177-SCRIBE



2047-1.2-8



2047PR-1-2



5515T-52



1179-FLX-2



9715-14-250



Foam Inlay Imperial Toolset for our metallic cases 1483K & 1483KHD Series - 12 Pcs



### FF3A16



42 x 210 x 445 mm

1 FF3A16

MTB-3-16-E



2101GC-160IP



2421GC-180IP



3658A-3, 3658A-5, 3658A-8



3735-5-120



3740-150



8224CIP



2855 D



0454800500, BFLB01



Foam Inlay Imperial Toolset for our metallic cases 1483K & 1483KHD Series - 30 Pcs



### FF3A17

|                   |   |        |
|-------------------|---|--------|
|                   |   |        |
| 48 x 205 x 450 mm | 1 | FF3A17 |

|   |  |
|---|--|
| BE-9780   |  |
| KE18-01   |  |
| 1300Z-1/4-5/16, 1300Z-3/8-7/16  |  |
| 1320RZ-1/4-5/16, 1320RZ-3/8-7/16  |  |
| 1931Z-1/4, 1931Z-7/32   |  |
| 1952Z-1/2, 1952Z-11/16, 1952Z-11/32, 1952Z-13/16, 1952Z-3/4, 1952Z-5/8, 1952Z-7/8, 1952Z-9/16 |  |
| 2628 GC-180IP   |  |
| 7758  |  |
| U-DS2018A, U-XID1415A, U-XID1618A   |  |

General Purpose Tool Kit - 109 pcs

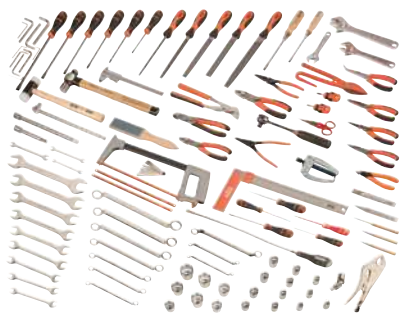

### 981001100

|     |       |             |
|-----|-------|-------------|
|     |       |             |
| 109 | 27 kg | 1 981001100 |

|  |  |
|--|--|
| 1546   |  |
| 2521GC-160   |  |
| 2630GC-180IP, 2630GC-200IP   |  |
| 6M-12-13, 6M-14-15, 6M-10-11, 6M-6-7, 6M-8-9, 6M-20-22, 6M-21-23, 6M-24-27, 6M-25-28 |  |
| 8150RN-1/2   |  |
| 8154-1/2, 2421GC-160, 8160-1/2, 8162-1/2, 8166-1/2                                   |  |
| 9048-400   |  |
| 9-469-00-0-0   |  |
| 1998M/10T  |  |
| 3733-4   |  |

|  |  |
|--|--|
| 3734-4   |  |
| 814-100  |  |
| 815-2-25, 815-1-100, 815-2-125   |  |
| 9710-8-150, 9710-6.5-125   |  |
| 2101GC-200HL   |  |
| 2800-180   |  |
| SC127  |  |
| 1-100-08-2-2, 1-100-10-2-2   |  |
| 1150-1/2H/P  |  |
| 2101D-140IP  |  |
| 2535F1   |  |
| 3906-300-24-2P   |  |
| 2951-250   |  |
| 2M-6-7, 2M-8-9, 2M-10-11, 2M-12-13, 2M-14-15, 2M-16-17, 2M-18-19, 2M-20-22, 2M-21-23, 2M-24-27   |  |
| 3645-150-C   |  |
| 4544-10  |  |
| 813-3-75, 813-4-100, 813-5.5-125   |  |
| 1-230-08-1-2   |  |
| 2430 GC-160 IP   |  |
| 3735-4-120   |  |
| 2900-180   |  |
| 3625W-35   |  |
| 479-16   |  |
| 869102500  |  |
| 1-170-08-2-2   |  |
| 1-210-08-2-2   |  |
| 8072 C, 8071 C   |  |
| 225-PLUS   |  |
| 2427 GC-200IP  |  |
| 3640-150-C   |  |
| 7800DM-18, 7800DM-17, 7800DM-16, 7800DM-11, 7800DM-10, 7800DM-15, 7800DM-14, 7800DM-13, 7800DM-12, 7800DM-19, 7800DM-23, 7800DM-22, 7800DM-21, 7800DM-20, 7800DM-24, 7800DM-26, 7800DM-28, 7800DM-30, 7800DM-32, 7800DM-27 |  |
| 813VDE-3-100   |  |
| 6224   |  |

Wall or Bench Mount Cabinet with Shutter and Hooks



### 1495CS18HK

|                     |   |              |
|---------------------|---|--------------|
|                     |   |              |
| 900 x 170 x 1800 mm | 1 | 1495CS18HK   |
| 900 x 170 x 1800 mm | 1 | 1495CS18BLHK |

Wall or Bench Mount Cabinet with Shutter



### 1495CS1

|                     |   |            |
|---------------------|---|------------|
|                     |   |            |
| 900 x 170 x 1500 mm | 1 | 1495CS15   |
| 900 x 170 x 1800 mm | 1 | 1495CS18   |
| 900 x 170 x 1500 mm | 1 | 1495CS15BL |
| 900 x 170 x 1800 mm | 1 | 1495CS18BL |

2-Door Wall Mount Tool Cabinets



### 1495CD60

|                    |   |          |
|--------------------|---|----------|
|                    |   |          |
| 900 x 250 x 602 mm | 1 | 1495CD60 |



## 2-Door Wheeled Tool Cabinets



### 1495CD60W



1605 x 450 x 625 mm

1 1495CD60W

## Tool Panel Auto Repair Tool Kit - 62 pcs



### 1495TP-AUTO-M1



900 x 25 x 500 mm

1 1495TP-AUTO-M1

|          |  |
|----------|--|
| 1495TP09 |  |
| BP910    |  |
| BP909TH  |  |
| BE-9678  |  |
| BE-9675  |  |

|  |  |  |
|--|--|--|
| 29M-30   |  |  |
| 2997-250   |  |  |
| 1995LM-9, 1995LM-8, 1995LM-6   |  |  |
| 3750   |  |  |
| 1177-SCRIBE  |  |  |
| K7801M-9, K7801M-10, K7801M-11, K7801M-12, K7801M-13, K7801M-14, K7801M-15, K7801M-16, K7801M-17, K7801M-18, K7801M-19, K7801M-21, K7801M-22, K7801M-23, K7801M-24, K7801M-30, K7801M-32 |  |  |
| K7806M-15, K7806M-21, K7806M-24, K7806M-27   |  |  |
| K8901M-32, K8901M-34, K8901M-36  |  |  |
| K8964D   |  |  |
| K8167S   |  |  |
| K8160D-3   |  |  |
| 2800-150   |  |  |
| 2900-150   |  |  |
| 3734S/6  |  |  |
| BE-8258TB  |  |  |
| 1495TP-ACHL40x 9, 1495TP-ACHL65x 9, 1495TP-ACHL20x 33  |  |  |

## Tool Panel Auto Repair Tool Kit - 53 pcs



### 1495TP-AUTO-M2



900 x 25 x 500 mm

1 1495TP-AUTO-M2

|  |  |
|--|--|
| 1495TP09   |  |
| BE301  |  |
| K7801TORX-E10, K7801TORX-E12, K7801TORX-E14, K7801TORX-E16, K7801TORX-E18, K7801TORX-E20 |  |
| K8160D-2   |  |
| BE301CM  |  |
| BWHEPSSH8  |  |
| BE51038, BE510310, BE510312  |  |
| BP822  |  |
| BP825  |  |
| 1495TP-ACHL40x 25, 1495TP-ACHL65x 4, 1495TP-ACHL20x 29                                   |  |
| 1495TP-AC4   |  |

## Tool Panel Auto Repair Tool Kit - 34 pcs



### 1495TP-AUTO-M3



900 x 25 x 500 mm

1 1495TP-AUTO-M3

|   |  |
|---|--|
| 1495TP09  |  |
| BE1GP5-T  |  |
| 6968  |  |
| BE1SP1F   |  |
| BE6OF108  |  |
| BE6307414F                                      |  |
| BE6OFW  |  |
| BE1FFWF   |  |
| BE63064514F1                                    |  |
| BE6810Z, BE6810                                 |  |
| BE6FCP  |  |
| 52  |  |
| 1546  |  |
| 2421GC-160, 6962-W, 8166-1/2                    |  |
| 5515M   |  |
| BE1P  |  |
| 7455-60   |  |
| BE1FLD2, BE1FLD1, BE1FLD3                       |  |
| BE65F65120                                      |  |
| 7764  |  |
| 8164-1/2  |  |
| BE6302712F                                      |  |
| 6954  |  |
| BE6701VAG                                       |  |
| BE62110   |  |
| BE1310P427                                      |  |
| 7406ZZ-21, 7406ZZ-16                            |  |
| BE1SP14L  |  |
| BE1GP5  |  |
| 1495TP-AC3                                      |  |
| 1495TP-ACHL20x 38, 1495TP-ACHL40, 1495TP-ACHL65 |  |



Tool Panel Auto Repair Tool Kit - 23 pcs



**1495TP-AUTO-M4**



900 x 25 x 500 mm

1 1495TP-AUTO-M4

|  |  |
|--|--|
| 1495TP09   |  |
| BS618  |  |
| 4545-N1, 4545-N11  |  |
| 4545-1, 4545-2   |  |
| MTB-3-16   |  |
| 361-14   |  |
| 8900SM-41  |  |
| BS52   |  |
| 8169-1/2, 8165-1/2   |  |
| 747-22, 747-21, 747-19, 747-17, 747-15, 747-14, 747-13, 747-12 |  |
| BS40VAG  |  |
| BS56   |  |
| BS100PSA1  |  |
| BS45BMW  |  |
| 1495TP-ACHL40x 10, 1495TP-ACHL65x 5, 1495TP-ACHL20x 20         |  |

|   |  |
|---|--|
| 1495TP09  |  |
| 319   |  |
| 484-1000  |  |
| SB3654BM-20   |  |
| 3625S-44  |  |
| B192.004.200  |  |
| BE-8258TB   |  |
| 2484/S4   |  |
| B194.030.150, B194.025.125, B194.020.100, B194.010.075  |  |
| 600.005.012   |  |
| BBS165  |  |
| K7801TORX-E10, K7801TORX-E12, K7801TORX-E14, K7801TORX-E16, K7801TORX-E18, K7801TORX-E20, K7801TORX-E24 |  |
| BBR203P920, BBR203P925, BBR203P930, BBR203P940, BBR203P945, BBR203P950, BBR203P955, BBR203P960          |  |
| 1495TP-ACHL40x 13, 1495TP-ACHL20x 38  |  |
| 8226  |  |

Tool Panel Auto Repair Tool Kit - 42 pcs

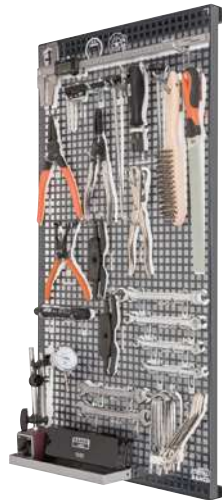

**1495TP-AUTO-M6**



900 x 25 x 500 mm

1 1495TP-AUTO-M6

|          |  |
|----------|--|
| 1495TP09 |  |
| FM10     |  |
| 782-U    |  |
| BBR405   |  |
| BBR400   |  |
| BBR210P3 |  |
| BBR6131  |  |
| BBR204   |  |
| BBR150I  |  |

Tool Panel Auto Repair Tool Kit - 32 pcs



**1495TP-AUTO-M5**



900 x 25 x 500 mm

1 1495TP-AUTO-M5

|  |  |
|--|--|
| BBR501011, BBR50121314                           |  |
| 2900-215   |  |
| 7823   |  |
| BBR100   |  |
| 1154   |  |
| 6M-16-17, 6M-14-15                               |  |
| 1949M-17-19, 1949M-12-13, 1949M-10-11, 1949M-8-9 |  |
| 1495TP-ACHL40x 2, 1495TP-ACHL20x 29              |  |
| 1495TP-AC3                                       |  |

Heavy Duty Tool Hanger Panels with Reinforced Frame

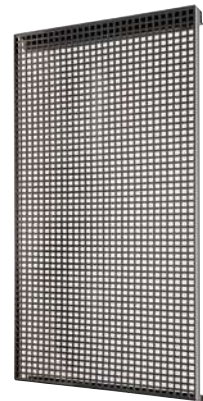

**1495TP09**



900 x 25 x 500 mm

1 1495TP09

Heavy Duty Tool Panels with Reinforced Frame

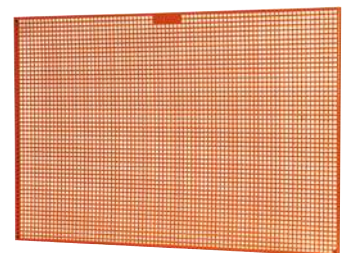

**1495TP**



|                    |              |
|--------------------|--------------|
| 500 x 23 x 600 mm  | 1 1495TP06   |
| 800 x 25 x 1200 mm | 1 1495TP12   |
| 800 x 23 x 1500 mm | 1 1495TP15   |
| 800 x 23 x 1800 mm | 1 1495TP18   |
| 500 x 25 x 600 mm  | 1 1495TP06GR |
| 800 x 25 x 1200 mm | 1 1495TP12GR |
| 800 x 25 x 1800 mm | 1 1495TP18GR |

Hanging Rail for 1495TP09 Panels



**1495TP09-RAIL**



40 x 57 x 440 mm



1 1495TP09-RAIL

Hook Kit for 1495 Cabinet and Panel - 35 Pcs

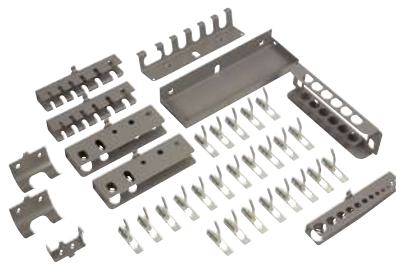

**1495CS-AC1**



2.11 kg



1 1495CS-AC1

Hammer 1-Slot Holders for Tool Panels



**1495TP-AC12**



0.07 kg



1 1495TP-AC12

Tool Panel Adaptors for Wooden and MDF Workbench Tops



**1495TP-AC1**



9.5 kg



1 1495TP-AC1

Combination Wrenches 12-Slot Holders for Tool Panels



**1495TP-AC10**



0.43 kg



1 1495TP-AC10

T-Handle 1-Slot Holders for Tool Panels



**1495TP-AC13**



0.04 kg



1 1495TP-AC13

Hook Kit for 1495 Cabinet and Panel - 24 Pcs

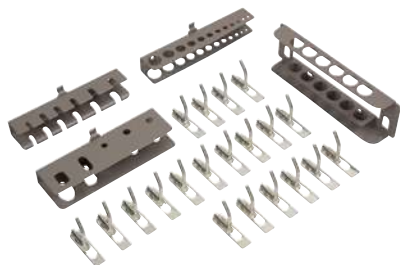

**1495CD-AC1**



1.22 kg



1 1495CD-AC1

Pin Punch 6-Slot Holders for Tool Panels

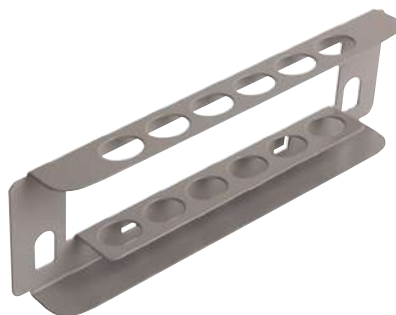

**1495TP-AC11**



0.16 kg



1 1495TP-AC11

Trays for Tool Panels



**1495TP-AC2**



0.44 kg



1 1495TP-AC2



Socket Hook and Tray Kit for Tool Panels



**1495TP-AC3**



0.45 kg



1 1495TP-AC3

Plastic Trays for Tool Panels



**1495TP-AC4**



0.125 kg



1 1495TP-AC4

Screwdriver 6-Slot Hooks for Tool Panels

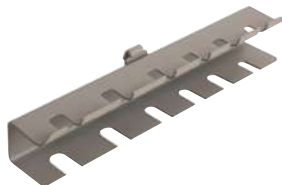

**1495TP-AC5**



0.14 kg



1 1495TP-AC5

Pliers 5-Slot Hooks for Tool Panels



**1495TP-AC6**



0.17 kg



1 1495TP-AC6

Grip 1-Slot Hooks for Tool Panels



**1495TP-AC7**



0.79 kg



1 1495TP-AC7

Hexagon 12-Slot L-Key Hooks for Tool Panels

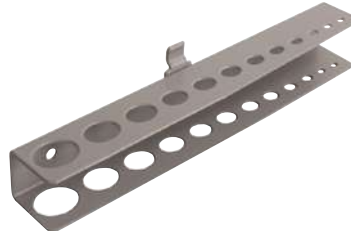

**1495TP-AC8**



0.12 kg



1 1495TP-AC8

Double Socket Wrench 12-Slot Hooks for Tool Panel



**1495TP-AC9**



0.43 kg



1 1495TP-AC9

L/U Shaped Hooks Set for Tool Panels - 5 Pcs



**1495TP-ACH**



0.116 kg

0.125 kg

0.144 kg

0.17 kg

0.102 kg

0.125 kg

0.146 kg

0.162 kg



1 1495TP-ACHL20

1 1495TP-ACHL40

1 1495TP-ACHL65

1 1495TP-ACHL90

1 1495TP-ACHU20

1 1495TP-ACHU40

1 1495TP-ACHU65

1 1495TP-ACHU90

Heavy Duty Steel Top Workbenches with Side Drawer Tower and 2-Leg 1800 mm x 750 mm x 1030 mm



**1495KCWB18TS**



1030 x 750 x 1800 mm

1030 x 750 x 1800 mm

1030 x 750 x 1800 mm

1030 x 750 x 1800 mm

1030 x 750 x 1800 mm

1030 x 750 x 1800 mm

1030 x 750 x 1800 mm

1030 x 750 x 1800 mm

1030 x 750 x 1800 mm

1030 x 750 x 1800 mm

1030 x 750 x 1800 mm

1030 x 750 x 1800 mm

1030 x 750 x 1800 mm



1 1495K6CWB18TS

1 1495K7CWB18TS

1 1495K8CWB18TS

1 1495K6CBKWB18TS

1 1495K7CBKWB18TS

1 1495K8CBKWB18TS

1 1495K6CBLWB18TS

1 1495K7CBLWB18TS

1 1495K8CBLWB18TS

1 1495K6CRDWB18TS

1 1495K7CRDWB18TS

1 1495K8CRDWB18TS



Heavy Duty Steel Top Workbenches with Side Drawer Tower and 2-Leg 1500 mm x 750 mm x 1030 mm



### 1495KCWB15TS



|                      |   |                 |
|----------------------|---|-----------------|
| 1030 x 750 x 1500 mm | 1 | 1495K6CWB15TS   |
| 1030 x 750 x 1500 mm | 1 | 1495K7CWB15TS   |
| 1030 x 750 x 1500 mm | 1 | 1495K8CWB15TS   |
| 1030 x 750 x 1500 mm | 1 | 1495K6CBKWB15TS |
| 1030 x 750 x 1500 mm | 1 | 1495K7CBKWB15TS |
| 1030 x 750 x 1500 mm | 1 | 1495K8CBKWB15TS |
| 1030 x 750 x 1500 mm | 1 | 1495K6CBLWB15TS |
| 1030 x 750 x 1500 mm | 1 | 1495K7CBLWB15TS |
| 1030 x 750 x 1500 mm | 1 | 1495K8CBLWB15TS |
| 1030 x 750 x 1500 mm | 1 | 1495K6CRDWB15TS |
| 1030 x 750 x 1500 mm | 1 | 1495K7CRDWB15TS |
| 1030 x 750 x 1500 mm | 1 | 1495K8CRDWB15TS |

Steel Top Kit for Convert 1475K Tool Trolley to Workbench



### 1495KW-TS



|                      |   |             |
|----------------------|---|-------------|
| 1030 x 750 x 1500 mm | 1 | 1495KWB15TS |
| 1030 x 750 x 1800 mm | 1 | 1495KWB18TS |

Heavy Duty Wooden Top Workbenches with Side Drawer Tower and 2-Leg 1800 mm x 750 mm x 1030 mm



### 1495KCWB18TW



|                      |   |                 |
|----------------------|---|-----------------|
| 1030 x 750 x 1800 mm | 1 | 1495K6CWB18TW   |
| 1030 x 750 x 1800 mm | 1 | 1495K7CWB18TW   |
| 1030 x 750 x 1800 mm | 1 | 1495K8CWB18TW   |
| 1030 x 750 x 1800 mm | 1 | 1495K6CBKWB18TW |
| 1030 x 750 x 1800 mm | 1 | 1495K7CBKWB18TW |
| 1030 x 750 x 1800 mm | 1 | 1495K8CBKWB18TW |
| 1030 x 750 x 1800 mm | 1 | 1495K6CBLWB18TW |
| 1030 x 750 x 1800 mm | 1 | 1495K7CBLWB18TW |
| 1030 x 750 x 1800 mm | 1 | 1495K8CBLWB18TW |
| 1030 x 750 x 1800 mm | 1 | 1495K6CRDWB18TW |
| 1030 x 750 x 1800 mm | 1 | 1495K7CRDWB18TW |
| 1030 x 750 x 1800 mm | 1 | 1495K8CRDWB18TW |

Heavy Duty Wooden Top Workbenches with Side Drawer Tower and 2-Leg 1500 mm x 750 mm x 1030 mm



### 1495KCWB15TW



|                      |   |                 |
|----------------------|---|-----------------|
| 1030 x 750 x 1500 mm | 1 | 1495K6CWB15TW   |
| 1030 x 750 x 1500 mm | 1 | 1495K7CWB15TW   |
| 1030 x 750 x 1500 mm | 1 | 1495K8CWB15TW   |
| 1030 x 750 x 1500 mm | 1 | 1495K6CBKWB15TW |
| 1030 x 750 x 1500 mm | 1 | 1495K7CBKWB15TW |
| 1030 x 750 x 1500 mm | 1 | 1495K8CBKWB15TW |
| 1030 x 750 x 1500 mm | 1 | 1495K6CBLWB15TW |
| 1030 x 750 x 1500 mm | 1 | 1495K7CBLWB15TW |
| 1030 x 750 x 1500 mm | 1 | 1495K8CBLWB15TW |
| 1030 x 750 x 1500 mm | 1 | 1495K6CRDWB15TW |
| 1030 x 750 x 1500 mm | 1 | 1495K7CRDWB15TW |
| 1030 x 750 x 1500 mm | 1 | 1495K8CRDWB15TW |

Heavy Duty Wooden Countertop Kit for Convert 1475k Series Trolley to Workbench



### 1495KWB-TW



|                      |   |             |
|----------------------|---|-------------|
| 1030 x 750 x 1500 mm | 1 | 1495KWB15TW |
| 1030 x 750 x 1800 mm | 1 | 1495KWB18TW |

Heavy Duty Steel Top Workbenches & Bottom Tray with 4 Legs - 1800 mm



### 1495WB18TSBT



|                      |   |                |
|----------------------|---|----------------|
| 1030 x 750 x 1800 mm | 1 | 1495WB18TSBT   |
| 1030 x 750 x 1800 mm | 1 | 1495WB18TSBLBT |

Heavy Duty Steel Top Workbenches & Bottom Tray with 4 Legs - 1500 mm



### 1495WB15TSBT



|                      |   |              |
|----------------------|---|--------------|
| 1030 x 750 x 1500 mm | 1 | 1495WB15TSBT |
|----------------------|---|--------------|





Heavy Duty Steel Top Workbenches with 4-Leg



**1495WB-TS**



|                      |   |               |
|----------------------|---|---------------|
| 1030 x 750 x 1500 mm | 1 | 1495WB15TS    |
| 1030 x 750 x 1800 mm | 1 | 1495WB18TS    |
| 1030 x 750 x 1800 mm | 1 | 1495WB18TSBK  |
| 1030 x 750 x 1500 mm | 1 | 1495WB15TSBL  |
| 1030 x 750 x 1800 mm | 1 | 1495WB18TSBL  |
| 1030 x 750 x 1500 mm | 1 | 1495WB15TSRED |
| 1030 x 750 x 1800 mm | 1 | 1495WB18TSRED |

Heavy Duty Chestnut Top Workbenches with 4-Leg



**1495WB-TW**



|                      |   |              |
|----------------------|---|--------------|
| 1030 x 750 x 1500 mm | 1 | 1495WB15TW   |
| 1030 x 750 x 1800 mm | 1 | 1495WB18TW   |
| 1030 x 750 x 1500 mm | 1 | 1495WB15TWGR |
| 1030 x 750 x 1800 mm | 1 | 1495WB18TWGR |

Steel Bottom Trays for 1495WB Workbenches



**1495WB1-AC**



|                    |   |              |
|--------------------|---|--------------|
| 30 x 504 x 1500 mm | 1 | 1495WB15-AC1 |
| 30 x 504 x 1800 mm | 1 | 1495WB18-AC1 |

Drawers with Trays or Dividers for 1495WB Workbenches



**1495WB-AC**



|                    |   |            |
|--------------------|---|------------|
| 105 x 500 x 500 mm | 1 | 1495WB-AC1 |
|--------------------|---|------------|

MDF and Galvanized Top Portable Workbenches



**1495FWBTD**



|                     |   |              |
|---------------------|---|--------------|
| 840 x 510 x 970 mm  | 1 | 1495FWB097TD |
| 840 x 510 x 1200 mm | 1 | 1495FWB120TD |

Galvanized Top Foldable Workbenches



**1495FWBTS**



|                     |   |              |
|---------------------|---|--------------|
| 840 x 510 x 1200 mm | 1 | 1495FWB120TS |
|---------------------|---|--------------|

**METALLIC TOOL BOXES**

Metallic Tool Box Aviation Toolkit - 129 Pcs



**1483KHD3RB-FF1**



|                    |   |                |
|--------------------|---|----------------|
| 335 x 260 x 565 mm | 1 | 1483KHD3RB-FF1 |
|--------------------|---|----------------|

**1483KHD3RB**

FF3A01

FF3A02

FF3A03

FF3A04

Metallic Tool Box Aviation Toolkit - 152 Pcs



**1483KHD3RB-FF2**



|                    |   |                |
|--------------------|---|----------------|
| 335 x 260 x 565 mm | 1 | 1483KHD3RB-FF2 |
|--------------------|---|----------------|

**1483KHD3RB**

FF3A05

FF3A06

FF3A07

FF3A08

2509

2535F2

3625N-32

481-400

7762

Metallic Tool Box General Purpose Toolkit - 193 Pcs



**1483KHD3RB-FF3**



335 x 260 x 565 mm

1 1483KHD3RB-FF3

|            |  |
|------------|--|
| 1483KHD3RB |  |
| FF3A09     |  |
| FF3A10     |  |
| FF3A11     |  |
| FF3A12     |  |

Metallic Tool Box General Purpose Toolkit - 146 Pcs



**1483KHD3RB-FF4**



335 x 260 x 565 mm

1 1483KHD3RB-FF4

|            |  |
|------------|--|
| 1483KHD3RB |  |
| FF3A10     |  |
| FF3A11     |  |
| FF3A12     |  |
| FF3A13     |  |

Metallic Tool Box Aviation Toolkit - 137 Pcs



**1483KHD3RB-FF5**



335 x 260 x 565 mm

1 1483KHD3RB-FF5

|            |  |
|------------|--|
| 1483KHD3RB |  |
| FF3A14     |  |
| FF3A15     |  |
| FF3A16     |  |
| FF3A17     |  |

Metallic Tool Box Aviation Tool Kit - 124 pcs



**1483KHD3RB-FF7**



335 x 260 x 565 mm

1 1483KHD3RB-FF7

|            |  |
|------------|--|
| 1483KHD3RB |  |
| 481-400    |  |
| 2535F1     |  |

|   |  |
|---|--|
| 7762  |  |
| 6950SL  |  |
| 6960, 6962  |  |
| 6956  |  |
| 7752  |  |
| 6966  |  |
| 6972H   |  |
| A6700DZ-3/16, A6700DZ-7/32, A6700DZ-1/4, A6700DZ-9/32, A6700DZ-5/16, A6700DZ-11/32, A6700DZ-3/8, A6700DZ-7/16, A6700DZ-1/2, A6700DZ-9/16                          |  |
| A6710DZ-1/4, A6710DZ-5/16, A6710DZ-11/32, A6710DZ-3/8, A6710DZ-7/16   |  |
| A6800DZ-3/16, A6800DZ-7/32, A6800DZ-1/4, A6800DZ-9/32, A6800DZ-5/16, A6800DZ-11/32, A6800DZ-3/8, A6800DZ-7/16, A6800DZ-1/2, A6800DZ-9/16                          |  |
| A6800DM-4   |  |
| BE-9780   |  |
| 59/S28-4  |  |
| 59S/TS-1/4  |  |
| 9070 P  |  |
| 808050  |  |
| 2058-BR   |  |
| KE18-01   |  |
| 1150-1/2H/P   |  |
| 2047-1-5.5  |  |
| 2047PR-1-2  |  |
| BE-8030   |  |
| BE-8150   |  |
| BE-8260   |  |
| BE-8350   |  |
| BE-8602   |  |
| BE-8610, BE-8620  |  |
| 5515T-52  |  |
| 1177-SCRIBE   |  |
| SR300-E   |  |
| 704Z-3/32   |  |
| MTB-3-16-M-E  |  |
| 2101GC-160IP  |  |
| 2427 GC-200IP   |  |
| 2855  |  |
| 8224CIP   |  |
| 2628 GC-160IP   |  |
| 2632  |  |
| 3734-3, 3734-5, 3734-8  |  |
| 1300Z-1/4-5/16  |  |
| 1320RZ-1/4-5/16, 1320RZ-3/8-7/16  |  |
| 1952Z-15/16, 1952Z-1, 1952Z-1/4, 1952Z-5/16, 1952Z-11/32, 1952Z-3/8, 1952Z-7/16, 1952Z-1/2, 1952Z-9/16, 1952Z-5/8, 1952Z-11/16, 1952Z-3/4, 1952Z-13/16, 1952Z-7/8 |  |
| 6Z-19/32-11/16  |  |
| 3625N-32  |  |



Heavy Duty Metallic Tool Boxes with 4 Drawers



**1483KHD4RB**

|                    |         |   |            |
|--------------------|---------|---|------------|
|                    |         |   |            |
| 390 x 260 x 593 mm | 15200 g | 1 | 1483KHD4RB |

Metallic Tool Boxes with 3 Drawers



**1483K3RB**

|                    |         |   |          |
|--------------------|---------|---|----------|
|                    |         |   |          |
| 334 x 260 x 523 mm | 10200 g | 1 | 1483K3RB |

Foam Inlay Imperial Toolset for our metallic cases 1483K & 1483KHD Series - 79 Pcs



**FF3A01**

|                   |   |        |
|-------------------|---|--------|
|                   |   |        |
| 64 x 245 x 505 mm | 1 | FF3A01 |

|  |  |  |
|--|--|--|
| A6700DZ-1/2, A6700DZ-1/4, A6700DZ-11/32, A6700DZ-3/8, A6700DZ-5/16, A6700DZ-7/16, A6700DZ-7/32, A6700DZ-9/32 |  |  |
| A6710DZ-3/8, A6710DZ-5/16, A6710DZ-7/16  |  |  |
| A6800DZ-1/4, A6800DZ-5/16, A6800DZ-7/32, A6800DZ-9/32  |  |  |
| A7400DM-10, A7400DM-13   |  |  |
| A7400DZ-1/2, A7400DZ-11/16, A7400DZ-3/4, A7400DZ-5/8, A7400DZ-9/16   |  |  |
| A7402DZ-1/2, A7402DZ-3/8, A7402DZ-7/16, A7402DZ-9/16   |  |  |
| 1320RZ-1/4-5/16, 1320RZ-3/8-7/16   |  |  |
| 59/S28-4   |  |  |
| 6Z-1.1/16-1.1/4, 6Z-1-1.1/8, 6Z-7/8-15/16  |  |  |
| 6950SL   |  |  |
| 6956   |  |  |
| 6958   |  |  |
| 6960, 6961   |  |  |
| 6966   |  |  |
| 6972H  |  |  |
| 7407H  |  |  |
| 7750SL   |  |  |
| 7752   |  |  |
| 7760, 7761   |  |  |
| 7764   |  |  |
| 7765   |  |  |
| 7766   |  |  |
| 7800DZ-1, 7800DZ-13/16, 7800DZ-7/8   |  |  |
| 8164-1/2   |  |  |
| 8171   |  |  |

Heavy Duty Metallic Tool Boxes with 3 Drawers



**1484THD3RB**

|                    |          |   |            |
|--------------------|----------|---|------------|
|                    |          |   |            |
| 300 x 220 x 520 mm | 12.40 kg | 1 | 1484THD3RB |

Metallic Tool Boxes with 2 Drawers



**1483K2RB**

|                    |        |   |          |
|--------------------|--------|---|----------|
|                    |        |   |          |
| 277 x 257 x 525 mm | 8200 g | 1 | 1483K2RB |

Heavy Duty Metallic Tool Boxes with 3 Drawers



**1483KHD3RB**

|                    |         |   |            |
|--------------------|---------|---|------------|
|                    |         |   |            |
| 305 x 233 x 523 mm | 13050 g | 1 | 1483KHD3RB |

Carts for 1483K Metallic Boxes



**1483CART**

|                    |         |   |          |
|--------------------|---------|---|----------|
|                    |         |   |          |
| 200 x 270 x 655 mm | 6.02 kg | 1 | 1483CART |

Foam Inlay Imperial Toolset for our metallic cases 1483K & 1483KHD Series - 13 Pcs



### FF3A02



39 x 210 x 445 mm

1 FF3A02

|                  |  |  |
|------------------|--|--|
| BE-3529          |  |  |
| BE-8020L         |  |  |
| BE-8155          |  |  |
| BE-8260          |  |  |
| BE-8601          |  |  |
| BE-8611, BE-8621 |  |  |
| 1150-1/2H/P      |  |  |
| 1177-SCRIBE      |  |  |
| 2047-1.2-8       |  |  |
| 2047PR-1-2       |  |  |
| 5515T-52         |  |  |
| 9715-14-250      |  |  |

Foam Inlay Imperial Toolset for our metallic cases 1483K & 1483KHD Series - 12 Pcs



### FF3A03



48 x 210 x 450 mm

1 FF3A03

|                                    |  |
|------------------------------------|--|
| MTB-3-16-M-E                       |  |
| 2101GC-160IP                       |  |
| 2421GC-180IP                       |  |
| 2855 D                             |  |
| 3658A-2, 3658A-3, 3658A-5          |  |
| 8224CIP                            |  |
| 0454800500, 1151-1, 1151-2, BFLB01 |  |

Foam Inlay Imperial Toolset for our metallic cases 1483K & 1483KHD Series - 20 Pcs



### FF3A04



45 x 210 x 445 mm

1 FF3A04

|  |  |
|--|--|
| U-XID1415A, U-XID1618A, U-DS2018A  |  |
| 1300Z-1/2-9/16, 1300Z-1/4-5/16, 1300Z-3/8-7/16, 1300Z-5/8-3/4, 1300Z-7/8-15/16, 1300Z-25/32-13/16, 1300Z-19/32-11/16 |  |
| 6Z-19/32-11/16, 6Z-25/32-13/16, 6Z-3/8-7/16, 6Z-5/8-3/4, 6Z-1/4-5/16, 6Z-1/2-9/16                                    |  |
| 9070C  |  |
| 1931Z-7/32, 1931Z-1/4  |  |
| 8157-15  |  |

Foam Inlay Imperial Toolset for our metallic cases 1483K & 1483KHD Series - 98 Pcs



### FF3A05



60 x 245 x 510 mm

1 FF3A05

|  |  |
|--|--|
| A6700DZ-1/2, A6700DZ-1/4, A6700DZ-11/32, A6700DZ-3/16, A6700DZ-3/8, A6700DZ-5/16, A6700DZ-7/16, A6700DZ-7/32, A6700DZ-9/16, A6700DZ-9/32 |  |
| A6710DZ-1/4, A6710DZ-11/32, A6710DZ-3/8, A6710DZ-5/16, A6710DZ-7/16  |  |
| A6800DM-4  |  |
| A6800DZ-1/2, A6800DZ-1/4, A6800DZ-11/32, A6800DZ-3/8, A6800DZ-5/16, A6800DZ-7/16, A6800DZ-3/16, A6800DZ-7/32, A6800DZ-9/16, A6800DZ-9/32 |  |

A7400DZ-1/2, A7400DZ-11/16, A7400DZ-13/16, A7400DZ-17/32, A7400DZ-19/32, A7400DZ-3/4, A7400DZ-5/8, A7400DZ-9/16

|            |  |
|------------|--|
| 59/S28-4   |  |
| BE-9780    |  |
| KE18-01    |  |
| 1544       |  |
| 2058-BR    |  |
| 59S/TS-1/4 |  |
| 6950SL     |  |
| 6956       |  |
| 6960, 6962 |  |
| 6966       |  |
| 6972H      |  |
| 7407H      |  |
| 7752       |  |
| 7750SL     |  |
| 7760, 7761 |  |
| 7764       |  |
| 7765       |  |
| 7766       |  |
| 808050     |  |
| 9071C      |  |
| 8164-1/2   |  |

Foam Inlay Imperial Toolset for our metallic cases 1483K & 1483KHD Series - 16 Pcs



### FF3A06



40 x 205 x 450 mm

1 FF3A06

|                  |  |  |
|------------------|--|--|
| BE-8030          |  |  |
| BE-8150, BE-8155 |  |  |
| BE-8260          |  |  |
| BE-8350          |  |  |
| BE-8602          |  |  |
| BE-8610, BE-8620 |  |  |
| 1177-SCRIBE      |  |  |
| 2047-1-5.5       |  |  |
| 2047PR-1-2       |  |  |
| 5515T-52         |  |  |
| 704Z-3/32        |  |  |
| 1150-1/2H/P      |  |  |
| 1179-FLX-2       |  |  |





Foam Inlay Imperial Toolset for our metallic cases 1483K & 1483KHD Series - 11 Pcs



### FF3A07

39 x 202 x 450 mm 1 FF3A07

|                        |  |
|------------------------|--|
| MTB-3-16-E             |  |
| 2101GC-160IP           |  |
| 2427 GC-200IP          |  |
| 2628 GC-160IP          |  |
| 2632                   |  |
| 2650                   |  |
| 2855                   |  |
| 3734-3, 3734-5, 3734-8 |  |
| 8224CIP                |  |

Foam Inlay Imperial Toolset for our metallic cases 1483K & 1483KHD Series - 23 Pcs



### FF3A08

43 x 205 x 450 mm 1 FF3A08

|   |  |
|---|--|
| 1320RZ-1/2-9/16, 1320RZ-5/16-11/32, 1320RZ-1/4-5/16, 1320RZ-3/8-7/16  |  |
| 1952Z-1/2, 1952Z-1/4, 1952Z-11/16, 1952Z-11/32, 1952Z-13/16, 1952Z-3/4, 1952Z-3/8, 1952Z-5/16, 1952Z-5/8, 1952Z-7/16, 1952Z-7/8, 1952Z-9/16 |  |
| 6Z-19/32-11/16, 6Z-1/2-9/16, 6Z-1/4-5/16, 6Z-13/16-7/8, 6Z-3/8-7/16, 6Z-5/16-11/32, 6Z-5/8-3/4  |  |

Foam Inlay Metric Toolset for our metallic cases 1483K & 1483KHD Series - 95 Pcs



### FF3A09

65 x 250 x 515 mm 1 FF3A09

|   |  |
|---|--|
| A6800DM-7, A6800DM-6, A6800DM-5.5, A6800DM-11, A6800DM-10, A6800DM-9, A6800DM-8, A6800DM-13, A6800DM-12   |  |
| A7402DM-19, A7402DM-18, A7402DM-17, A7402DM-12, A7402DM-11, A7402DM-10, A7402DM-16, A7402DM-15, A7402DM-14, A7402DM-13  |  |
| 1544  |  |
| 2058-BR   |  |
| 6700SM-8, 6700SM-7, 6700SM-6, 6700SM-5.5, 6700SM-12, 6700SM-11, 6700SM-10, 6700SM-9, 6700SM-13  |  |
| 6709M-8, 6709M-6, 6709M-5, 6709M-4, 6709M-3   |  |
| 6709PH-2, 6709PH-1, 6709PH-3  |  |
| 6709TORX-T25, 6709TORX-T20, 6709TORX-T15, 6709TORX-T10, 6709TORX-T40, 6709TORX-T30, 6709TORX-T27, 6709TORX-T9, 6709TORX-T8                                      |  |
| 6950SL  |  |
| 6954  |  |
| 6956  |  |
| 6958  |  |
| 6960, 6961, 6962, 6962L   |  |
| 6966  |  |
| 6972H   |  |
| 7400SM-8, 7400SM-7, 7400SM-6, 7400SM-19, 7400SM-18, 7400SM-17, 7400SM-22, 7400SM-12, 7400SM-11, 7400SM-10, 7400SM-9, 7400SM-16, 7400SM-15, 7400SM-14, 7400SM-13 |  |
| 7407H   |  |
| 7409M-10, 7409M-8, 7409M-7, 7409M-6, 7409M-5, 7409M-4, 7409M-3  |  |
| 7409TORX-T27, 7409TORX-T25, 7409TORX-T50, 7409TORX-T45, 7409TORX-T40, 7409TORX-T30  |  |
| 7750SL  |  |
| 7754  |  |
| 7758  |  |
| 7760, 7761  |  |
| 7764  |  |
| 7765  |  |
| 7766  |  |
| 8164-1/2  |  |

Foam Inlay Metric Toolset for our metallic cases 1483K & 1483KHD Series - 53 Pcs



### FF3A10

39 x 205 x 445 mm 1 FF3A10

|                   |  |
|-------------------|--|
| BE-8020L, BE-8030 |  |
| BE-8155           |  |
| BE-8260           |  |
| BE-8350           |  |
| BE-8601, BE-8602  |  |
| BE-8610, BE-8620  |  |
| BE-9770           |  |
| 2047-0.8-4        |  |
| 2047PR-1-2        |  |
| 808050P           |  |
| 808050S           |  |
| 59S/31-1          |  |

Cantilever Metallic Box with Foams General Purpose Tool Kit - 69 pcs



### 3149-ORFF1

220 x 220 x 560 mm 1 3149-ORFF1

|  |  |
|--|--|
| 111M-19, 111M-18, 111M-17, 111M-16, 111M-15, 111M-14, 111M-13, 111M-12, 111M-11, 111M-10, 111M-8, 111M-9 |  |
| 2953-250   |  |
| 224 D  |  |
| 2171G-160  |  |
| 2470 G-200   |  |
| BE-9770  |  |
| 611-3.5-75, 611-5.5-125, 611-6.5-150   |  |
| 613-3-100, 613-4-125   |  |
| 615-2-25, 615-1-100, 615-2-125, 615-3-150  |  |
| KBSK-01  |  |
| MTG-5-19-E   |  |
| 482-30   |  |
| 3625W-28   |  |



|   |  |
|---|--|
| 3745-150  |  |
| 3740-150  |  |
| 3734-3, 3734-5  |  |
| 3735-5-120  |  |
| 3149-OR   |  |
| 2678 G-200  |  |
| 8160-10, 8160-5   |  |
| 8158-10   |  |
| SBS81   |  |
| 8166  |  |
| 7772H   |  |
| 7800SM-15, 7800SM-16, 7800SM-13,<br>7800SM-14, 7800SM-19, 7800SM-20,<br>7800SM-17, 7800SM-18, 7800SM-23,<br>7800SM-24, 7800SM-21, 7800SM-22,<br>7800SM-27, 7800SM-32, 7800SM-30,<br>7800SM-11, 7800SM-12, 7800SM-10 |  |

Cantilever Metallic Box General Purpose Tool Kit - 69 pcs



**3149-ORTS1**

220 x 220 x 560 mm 1 3149-ORTS1

|  |  |
|--|--|
| 111M-19, 111M-18, 111M-17, 111M-16,<br>111M-15, 111M-14, 111M-13, 111M-12,<br>111M-11, 111M-10, 111M-9, 111M-8 |  |
|--|--|

|   |  |
|---|--|
| S240                                      |  |
| 2953-250                                  |  |
| 224 D                                     |  |
| 2171G-160                                 |  |
| 2678 G-200                                |  |
| 2470 G-200                                |  |
| BE-9770                                   |  |
| 611-3.5-75, 611-5.5-125, 611-6.5-150      |  |
| 613-3-100, 613-4-125                      |  |
| 615-2-25, 615-1-100, 615-2-125, 615-3-150 |  |
| KBSK-01                                   |  |
| MTG-5-19-E                                |  |
| 482-30                                    |  |
| 3625W-28                                  |  |
| 3745-150                                  |  |
| 3740-150                                  |  |
| 3734-3, 3734-5                            |  |
| 3735-5-120                                |  |
| 3149-OR                                   |  |

Wheeled Cantilever Metallic Tool Box



**1497MBW**

549 x 400 x 1213 mm 250 kg 1 1497MBW

Metallic Tool Boxes with 5 Compartments and Locking Capability



**3149-OR**

200 x 220 x 530 mm 4370 g 1 3149-OR

Cantilever Style Tool Boxes with 7 Compartments



**1497MBF750**

250 x 200 x 530 mm 15 kg 1 1497MBF750

Cantilever Style Tool Boxes with 5 Compartments



**1497MBF550**

200 x 200 x 530 mm 12 kg 1 1497MBF550

Cantilever Style Tool Boxes with 3 Compartments



**1497MBF350**

160 x 200 x 530 mm 10 kg 1 1497MBF350

Metallic Tool Boxes with 3/5 Compartments and Locking Capability



**9601**

|                    |        |   |           |
|--------------------|--------|---|-----------|
| 190 x 210 x 300 mm | 2450 g | 1 | 960100010 |
| 190 x 210 x 400 mm | 3400 g | 1 | 960100020 |
| 190 x 210 x 500 mm | 3670 g | 1 | 960100030 |
| 245 x 210 x 400 mm | 4400 g | 1 | 960100050 |
| 245 x 210 x 500 mm | 4840 g | 1 | 960100060 |



Mason Tool Chests 530 mm x 290 mm x 290 mm



**1496MB2**

290 x 290 x 530 mm 40 kg 1 1496MB2

Mason Tool Chests 690 mm x 360 mm x 310 mm



**1496MB3**

310 x 360 x 690 mm 60 kg 1 1496MB3

Mason Tool Chests 830 mm x 440 mm x 340 mm



**1496MB4**

340 x 440 x 830 mm 80 kg 1 1496MB4

Mason Tool Chests 910 mm x 530 mm x 530 mm



**1496MB5**

530 x 530 x 910 mm 150 kg 1 1496MB5

Plastic Tool Box General Purpose Tool Kit - 37 pcs



**4750PTB65TS5**

285 x 300 x 650 mm 1 4750PTB65TS5

- 2430 D-140 IP
- 2630D-160
- MT-TS-3
- 9572
- BE-9884
- 2446
- SL25
- 427-16

670 mm Heavy Duty Plastic Tool Boxes



**4750PTBW67**

420 x 472 x 675 mm 50 kg 1 4750PTBW67

Blow Mould Case with Adjustable Torque Wrench and Impact Socketry Toolkit - 11 pcs



**4750BMC10FF1**

84 x 341 x 447 mm 1 4750BMC10FF1

- 4750BMC10
- BWSHK21
- BWSMB15
- BWSMB17
- BWSS12P5
- BWTVCTT355
- 74W9-200
- 9R-1/2

470 mm Heavy Duty Plastic Tool Boxes



**4750PTBW47**

60 l 30 kg 1 4750PTBW47

650 mm Heavy Duty Plastic Tool Boxes



**4750PTB65**



285 x 300 x 650 mm

2 4750PTB65

600 mm Heavy Duty Plastic Tool Boxes



**4750PTB60**



37 l

20 kg

3 4750PTB60

500 mm Heavy Duty Plastic Tool Boxes



**4750PTB50**



27 l

20 kg

3 4750PTB50

Double Wall Shock Absorbing Case



**4750BMC**



- 51 x 117 x 260 mm
- 67 x 214 x 230 mm
- 70 x 230 x 280 mm
- 90 x 230 x 320 mm
- 93 x 257 x 357 mm
- 76 x 256 x 355 mm
- 80 x 287 x 380 mm
- 105 x 297 x 393 mm
- 84 x 341 x 450 mm

- 1 4750BMC3
- 1 4750BMC4
- 1 4750BMC5
- 1 4750BMC5.5
- 1 4750BMC6
- 1 4750BMC7
- 1 4750BMC9
- 1 4750BMC9.5
- 1 4750BMC10

**TEXTILE & LEATHER EQUIPMENT**

Wheeled Textile Bag MRO Toolkit - 72 Pcs



**4750FB2W-TS001**



390 x 400 x 685 mm

1 4750FB2W-TS001

- 4750FB2W-24A
- SL25
- BE-8030, BE-8242
- S240
- BE-8155
- BE-8600, BE-8610, BE-8620
- BE-8800, BE-8810, BE-8820
- BE-8040S
- 2628 G-180

2101G-180

7224

1520 G

MTB-5-25

MA421

268

325

479-16

KERU-01

BFLA01

5515T

9071

Closed Top Bag MRO Toolkit - 61 Pcs



**4750FB2-19TS001**



500 mm

250 mm

1 4750FB2-19TS001

4750FB2-19A

BE-8010S, BE-8040S, BE-8050S, BE-8220S

BE-8610S, BE-8620S, BE-8630S

BE-8800S, BE-8820S, BE-8830S

706-4

PC-12-VEN

1-210-08-2-2

2101G-180

2233 D-200

2628 G-180

268

3830-20-VIP, 3830-25-VIP

3834-ARBR-730

4130

424P-16, 424P-20, 424P-25

428-16

484-1250

806-1-1

8231

9031

SL25





Fabric Tool Bag Service Engineer's Toolkit - 51 Pcs



**4750FB4-18TS001**

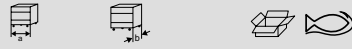

450 mm 190 mm 1 4750FB4-18TS001

|                  |  |
|------------------|--|
| 4750FB4-18       |  |
| 2101G-160        |  |
| 2628 G-180       |  |
| 2430 G-160       |  |
| 1RM/SH8          |  |
| 7223             |  |
| 2233 D-200       |  |
| SL25             |  |
| 9070             |  |
| 9031             |  |
| 483-20           |  |
| BE-8020, BE-8040 |  |
| BE-8150, BE-8155 |  |
| BE-8610, BE-8620 |  |
| SC127            |  |
| SQZ150003        |  |
| BE-9777          |  |
| MTB-5-25         |  |

Leather Bag Electrician Toolkit - 28 Pcs



**3049-2**



180 x 435 x 270 mm 1 3049-2

|  |  |
|--|--|
| 268                                    |  |
| 5470-140                               |  |
| 111M-7, 111M-8, 111M-10, 111M-13       |  |
| 2744                                   |  |
| 2427 S-200                             |  |
| 8045LVDE                               |  |
| BE-9765                                |  |
| 2705R                                  |  |
| 481-300                                |  |
| 9072 P                                 |  |
| 2628 S-180                             |  |
| 2101S-160                              |  |
| BE-8820S                               |  |
| BE-8220S, BE-8040S, BE-8050S, BE-8255S |  |
| BE-8610S, BE-8620S                     |  |
| B146.006.100                           |  |
| 4750-FOLT-1                            |  |

Leather Bag Electrician Toolkit - 16 Pcs



**982000170**



290 x 195 x 440 mm 1 982000170

|  |  |
|--|--|
| 4750-FOLT-1  |  |
| 2101GC-160IP   |  |
| 2800 N   |  |
| 2630GC-160IP   |  |
| 2421GC-160   |  |
| 2521GC-160   |  |
| 8071 C IP  |  |
| B196.065.150, B196.055.125, B196.030.100, B196.040.100 |  |
| B197.002.100, B197.001.080                             |  |
| SC127  |  |
| 2820EF2  |  |
| MTB-3-16   |  |
| 6224   |  |

Leather Bag General Purpose Toolkit - 32 Pcs



**982000320**

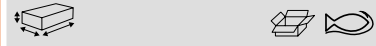

280 x 200 x 435 mm 1 982000320

|                            |  |
|----------------------------|--|
| 4750-FOLT-1                |  |
| 2101D-160IP                |  |
| 224 D                      |  |
| 2630D-180                  |  |
| 2430 D-160 IP              |  |
| 8071 C IP                  |  |
| 483-20                     |  |
| 6M/8C                      |  |
| 541D-180                   |  |
| 2951-180                   |  |
| B191.030.075, B191.040.100 |  |
| B190.100.200, B190.065.150 |  |
| B192.001.100, B192.002.125 |  |
| SC127                      |  |
| 2820EF2                    |  |
| BE-9777                    |  |
| MTB-3-16                   |  |

Leather Bag General Purpose Toolkit - 34 Pcs



**982000350**



280 x 200 x 440 mm 1 982000350

|              |  |
|--------------|--|
| 4750-FOLT-1  |  |
| 2101GC-160IP |  |
| 2630GC-180IP |  |

|  |  |
|--|--|
| 2900-180                                 |  |
| 2800-180                                 |  |
| 1998M/10T                                |  |
| 8072 C IP                                |  |
| 2951-250                                 |  |
| B190.100.200, B190.065.150, B190.040.100 |  |
| B192.001.100, B192.002.125               |  |
| SC127                                    |  |
| 6M/8C                                    |  |
| 479-16                                   |  |
| 2430 GC-200 IP                           |  |
| 1-110-08-2-2                             |  |
| 6224                                     |  |

Fabric tool folder with foam, 51 pcs



**4750FB5BFF1**  
 62 x 275 x 330 mm 1 4750FB5BFF1

|            |  |
|------------|--|
| 4750FB5B   |  |
| 808050P    |  |
| MTB-5-25   |  |
| 2101G-160  |  |
| 2628 G-180 |  |
| BE-9578    |  |
| 9070       |  |
| 59/S31B    |  |

Mini Folder Case General Purpose Toolkit - 36 Pcs



**4750FB5ATS001**  
 275 mm 170 mm 1 4750FB5ATS001

|            |  |
|------------|--|
| 4750FB5A   |  |
| 2058/S26   |  |
| 808050     |  |
| 8070       |  |
| 2101G-160  |  |
| 2628 G-180 |  |

Zipper Wallet General Purpose Toolkit - 7 Pcs



**9848**  
 50 x 275 x 330 mm 1 9848

|                  |  |
|------------------|--|
| 8160             |  |
| 7890             |  |
| 8070             |  |
| BE-8020, BE-8040 |  |
| BE-8610          |  |
| TL AA-SA-SL      |  |

Zipper Wallet Electrician Toolkit - 17 Pcs



**9852**  
 360 x 40 x 240 mm 1 9852

|             |  |
|-------------|--|
| 7890        |  |
| 8160        |  |
| 8070        |  |
| TL AA-SA-SL |  |

|                           |  |
|---------------------------|--|
| 2421 G-160                |  |
| 2101G-160                 |  |
| 2628 G-180                |  |
| BE-8210, BE-8040          |  |
| BE-8150, BE-8155          |  |
| BE-8600, BE-8610, BE-8620 |  |
| 8045LVDE                  |  |
| K-AP-1                    |  |

Zipper Wallet Electrician Toolkit - 7 Pcs



**9841**  
 275 x 48 x 330 mm 1 9841

|                  |  |
|------------------|--|
| 7190             |  |
| 7890             |  |
| TL AA-SA-SL      |  |
| BE-8020, BE-8040 |  |
| BE-8610          |  |
| 8070             |  |

Backpack with Anti-Slip Plastic Hard Bottom



**4750FB8**  
 560 x 190 x 335 mm 4 4750FB8





24 L Open Top Fabric Tool Bags with Rigid Base



**3100TB**



345 x 240 x 485 mm

1 3100TB

32 L Closed Top Fabric Tool Bags with Rigid Base



**4750FB2-19A**



370 x 230 x 470 mm

4 4750FB2-19A

12 L Electrician Fabric Tool Bags



**4750FB3-12**



285 x 190 x 285 mm

1 4750FB3-12

32 L Open Top Fabric Tool Bags with Rigid Base



**4750FB1-19A**



355 x 230 x 470 mm

1 4750FB1-19A

48 L Closed Top Fabric Tool Bags with Rigid Base



**4750FB2-24A**



380 x 260 x 600 mm

2 4750FB2-24A

17 L Laptop and Tool Bags



**4750FB4-18**



350 x 150 x 430 mm

4 4750FB4-18

32 L Open Top Deluxe Fabric Tool Bags with Rigid Base



**4750FB1-19B**



365 x 225 x 480 mm

4 4750FB1-19B

73 L Wheeled Fabric Tool Bags with Telescopic Handle



**4750FB2W-24A**



385 x 325 x 665 mm

1 4750FB2W-24A

21 L Closed Top Fabric Tool Bags



**4750FB6-13**



275 x 250 x 310 mm

1 4750FB6-13

36 L Closed Top Fabric Tool Bags



**4750FB6-19**



290 x 265 x 480 mm

1 4750FB6-19

6 L Medium Fabric Tool Folders with Rubberized Handle



**4750FB5B**



62 x 275 x 330 mm

1 4750FB5B

11 L Fabric Tool Folder with Rubberised Handle for 2x 1/3 Fit&Go Foams



**4750FB5-FG2**



90 x 210 x 470 mm

1 4750FB5-FG2

Fabric Tool Bags for 416-SET-1



**4750-LV-1**



85 x 43 x 1800 mm

1 4750-LV-1

51 x 43 x 1800 mm

1 4750-LV-2

12 L Max Fabric Tool Folders with Rubberized Handle



**4750FB5C**



80 x 305 x 403 mm

8 4750FB5C

Folding Front Leather Tool Cases



**4750-FOLTC-1**



290 x 195 x 440 mm

1 4750-FOLTC-1

2.4 L Mini Fabric Tool Folders



**4750FB5A**



50 x 168 x 273 mm

1 4750FB5A

8 L Fabric Tool Folder with Rubberised Handle for 1x 1/3 Fit&Go Foam



**4750FB5-FG1**



65 x 210 x 470 mm

1 4750FB5-FG1

Tube Style Leather Tool Cases



**4750-TOCST-1**



220 x 170 x 495 mm

1 4750-TOCST-1



Electrician Leather Tool Cases



**4750-VDEC**



290 x 190 x 445 mm

1 4750-VDEC

Zip Bags 3 Units Set - 90 mm



**4750FB7-01**



135 x 10 x 215 mm

60 4750FB7-01

Zip Bags 3 Units Set - 145 mm



**4750FB7-02**



205 x 10 x 310 mm

60 4750FB7-02

Orange Zip Bag - 90 mm



**4750FB7ORLT**



135 x 10 x 215 mm

120 4750FB7ORLT

Orange Zip Bag - 145 mm



**4750FB7ORBG**



205 x 10 x 310 mm

120 4750FB7ORBG

Heavy Duty Belts with Cushion and Stainless Steel Twin-Pin Buckle



**4750-HDB-2**



190 x 50 x 900 mm

1 4750-HDB-2

Heavy Duty Belt Set



**4750-HDBS-2**



330 x 170 x 900 mm

1 4750-HDBS-2

Quick Release Fabric Adjustable Belts



**4750-QRFB-1**



50 x 4 x 1180 mm

1 4750-QRFB-1

Junior Three Pouch Belt Set



**4750-JU3PB**



125 x 55 x 395 mm

1 4750-JU3PB-1

Heavy Duty Leather Belts



**4750-HDLB**



47 x 4 x 1380 mm

1 4750-HDLB-1

Two Pocket Fixings Pouches



**4750-2PP**



285 x 130 x 265 mm

1 4750-2PP-1

Multipurpose Holders



**4750-MPH-1**



240 x 50 x 155 mm

1 4750-MPH-1

Roll Covers for Tools



**4750-ROCO-1**



320 x 5 x 370 mm

1 4750-ROCO-1

Right and Left Handed Drill Holsters



**4750-DHO-3**



320 x 73 x 175 mm

1 4750-DHO-3

Squeeze Knife Holders



**4750-KNHO-1**



205 x 35 x 105 mm

1 4750-KNHO-1

Flooring and Roofing Knee Pads



**4750-KP**



200 x 30 x 170 mm

1 4750-KP-1

Electrician's Pouches



**4750-EP**



345 x 120 x 260 mm

1 4750-EP-1

Vertical Mobile Phone Holders



**4750-VMPH-1**



170 x 35 x 100 mm

1 4750-VMPH-1

Braces with Clips



**4750-BWC-1**



750 x 20 x 105 mm

1 4750-BWC-1







**BAHCO**

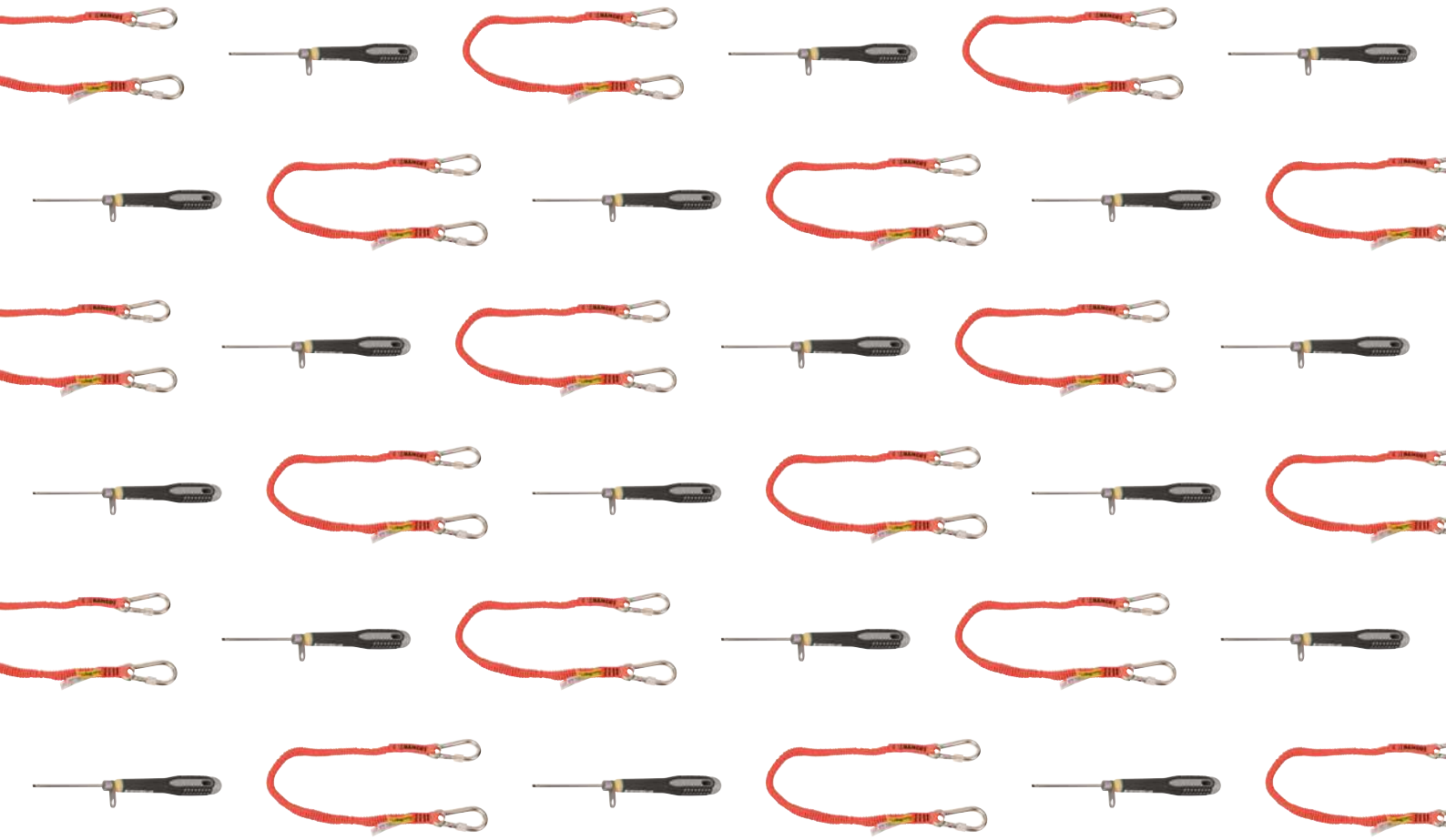

## Tools @ Height



## TOOL STORAGE & LANYARDS

High Visibility Orange Strap Lanyards with Swivel Carabiner 1 kg



**3875-LY60**



g



135 g

1 3875-LY60

Strap Lanyards with Fixed Carabiner and Interchangeable Loop 1 kg



**3875-LY3**

g



125 g

8 3875-LY3

Wrist Lanyards with Exchangeable Loop and Barrel Lock 1 kg



**3875-WL1**

g



40 g

8 3875-WL1

Connecting Loops for Lanyard



**3875-QL1**

g



40 g

8 3875-QL1

Retractable Lanyards with Fixed Carabiner 0.9 kg



**3875-RL1**

g



200 g

1 3875-RL1

Connecting Loops for Retractable Lanyard



**3875-QRL1**

g



40 g

1 3875-QRL1

Retractable Lanyards with Fixed Carabiner 1 kg



**3875-RL2**

g



212 g

1 3875-RL2

High Visibility Orange Strap Lanyards with Fixed Carabiner 3 kg



**3875-LY70**

g



172 g

1 3875-LY70

Strap Lanyards with Fixed Carabiner and Locking Device 3 kg



**3875-LY4**

g



180 g

8 3875-LY4

Strap Lanyards with Fixed Carabiner 3 kg



**3875-LY1**

g



170 g

8 3875-LY1

Strap Lanyards with Fixed Carabiner and Fixed Loop 3 kg



**3875-LY2**

g



120 g

8 3875-LY2

High Visibility Orange Strap Lanyards with Fixed Carabiner 6 kg



**3875-LY8**



330 g



1 3875-LY8

Coiled Lanyards with 1.5 mm Wire Loop String



**439000001**



130 g



1 439000001

Coiled Lanyards with Swivel Carabiner 3 kg



**439000003**



160 g



1 439000003

High Visibility Orange Strap Lanyards with Fixed Carabiner 12 kg



**3875-LY10**



270 g



1 3875-LY10

Steel String Lanyards



**3875-SL1**



10 g



1 3875-SL1

High Visibility Orange Strap Lanyards with Plastic Clip



**439000004**



13 g



1 439000004

Coiled Lanyards with 1 mm Wire Loop String



**439000000**



100 g



1 439000000

Coiled Lanyards with Swivel Carabiner 2 kg



**439000002**



130 g



1 439000002

Bags for Working at Height



**3875-HB10**



260 x 130 x 130 mm



1 3875-HB10





Lifting Bags with Single Reinforced Lifting Straps



**3875-HB30/3875-HB60**



270 x 270 x 330 mm  
340 x 340 x 620 mm

1 3875-HB30  
6 3875-HB60

Backpacks with Durable Polyester Large Size



**3875-BP2**



240 x 340 x 440 mm

8 3875-BP2

Multipurpose Pouches with 2 Large Pockets and 4 Safety Rings for Lanyard Attachment



**4750-UP-2**



270 x 145 x 270 mm

1 4750-UP-2

Lifting Bags with Double Reinforced Lifting Straps



**3875-HB100**



390 x 390 x 890 mm

1 3875-HB100

Pouches with 2 Large Pockets and 6 Safety Rings for Lanyard Attachment



**3875-MHP6**



100 x 185 x 370 mm

1 3875-MHP6

Hammer Holster Belt Pouches with 1 Safety Ring for Lanyard Attachment



**4750-HHO-2**



110 x 65 x 165 mm

1 4750-HHO-2

Rigid Case Lifting Bags with Double Reinforced Lifting Straps



**3875-SB70**



790 x 300 x 750 mm

1 3875-SB70

Three Pouch Set Belts with 4 Safety Rings for Lanyard Attachment



**3PB-2**



80 x 270 x 1350 mm

1 4750-3PB-2

Heavy Duty Belts with 6 Safety Rings for Lanyard Attachment



**4750-HDLB-TAH**



50 x 120 x 1410 mm

1 4750-HDLB-TAH

## WRENCHES

ERGO™ 90 Series Adjustable Wrenches with Quick Link



ergo



### TAH90



| Length    | Quick Link | Quantity | Part Number |
|-----------|------------|----------|-------------|
| 158mm/6"  | 20 mm      | 1        | TAH9070     |
| 250mm/10" | 31 mm      | 1        | TAH9072     |

80 Series Adjustable Wrenches with Quick Link



### TAH80



| Length    | Quick Link | Quantity | Part Number |
|-----------|------------|----------|-------------|
| 110mm/4"  | 13 mm      | 1        | TAH8069     |
| 155mm/6"  | 20 mm      | 1        | TAH8070     |
| 205mm/8"  | 27 mm      | 1        | TAH8071     |
| 255mm/10" | 31 mm      | 1        | TAH8072     |
| 305mm/12" | 34 mm      | 1        | TAH8073     |
| 380mm/15" | 44 mm      | 1        | TAH8074     |
| 460mm/18" | 53 mm      | 1        | TAH8075     |
| 110mm/4"  | 13 mm      | 1        | TAH8069C    |
| 155mm/6"  | 20 mm      | 1        | TAH8070C    |
| 205mm/8"  | 27 mm      | 1        | TAH8071C    |
| 255mm/10" | 31 mm      | 1        | TAH8072C    |
| 305mm/12" | 34 mm      | 1        | TAH8073C    |
| 380mm/15" | 44 mm      | 1        | TAH8074C    |
| 460mm/18" | 53 mm      | 1        | TAH8075C    |

Podger Wrenches with Safety D-Shackle



### TAH84



| Length    | Quick Link | Quantity | Part Number  |
|-----------|------------|----------|--------------|
| 405mm/16" | 41 mm      | 1        | TAH84-PODGER |

Metric Combination Wrenches with Safety Spring



### TAH111M



| Length | Quantity | Part Number  |
|--------|----------|--------------|
| 6 mm   | 112 mm   | 1 TAH111M-6  |
| 7 mm   | 120 mm   | 1 TAH111M-7  |
| 8 mm   | 130 mm   | 1 TAH111M-8  |
| 9 mm   | 136 mm   | 1 TAH111M-9  |
| 10 mm  | 144 mm   | 1 TAH111M-10 |
| 11 mm  | 153 mm   | 1 TAH111M-11 |
| 12 mm  | 160 mm   | 1 TAH111M-12 |
| 13 mm  | 165 mm   | 1 TAH111M-13 |
| 14 mm  | 177 mm   | 1 TAH111M-14 |
| 15 mm  | 185 mm   | 1 TAH111M-15 |
| 16 mm  | 195 mm   | 1 TAH111M-16 |
| 17 mm  | 200 mm   | 1 TAH111M-17 |
| 18 mm  | 208 mm   | 1 TAH111M-18 |
| 19 mm  | 215 mm   | 1 TAH111M-19 |
| 20 mm  | 240 mm   | 1 TAH111M-20 |
| 21 mm  | 250 mm   | 1 TAH111M-21 |
| 22 mm  | 250 mm   | 1 TAH111M-22 |
| 23 mm  | 270 mm   | 1 TAH111M-23 |
| 24 mm  | 270 mm   | 1 TAH111M-24 |
| 25 mm  | 290 mm   | 1 TAH111M-25 |
| 27 mm  | 310 mm   | 1 TAH111M-27 |
| 30 mm  | 330 mm   | 1 TAH111M-30 |
| 32 mm  | 345 mm   | 1 TAH111M-32 |
| 34 mm  | 347 mm   | 1 TAH111M-34 |
| 36 mm  | 400 mm   | 1 TAH111M-36 |
| 41 mm  | 438 mm   | 1 TAH111M-41 |
| 46 mm  | 500 mm   | 1 TAH111M-46 |
| 50 mm  | 540 mm   | 1 TAH111M-50 |
| 55 mm  | 560 mm   | 1 TAH111M-55 |

Imperial Combination Wrenches with Safety Spring



### TAH111Z



| Length  | Quantity | Part Number    |
|---------|----------|----------------|
| 1/4 in  | 112 mm   | 1 TAH111Z-1/4  |
| 5/16 in | 130 mm   | 1 TAH111Z-5/16 |
| 3/8 in  | 140 mm   | 1 TAH111Z-3/8  |
| 7/16 in | 153 mm   | 1 TAH111Z-7/16 |

| Length     | Quantity | Part Number       |
|------------|----------|-------------------|
| 1/2 in     | 169 mm   | 1 TAH111Z-1/2     |
| 9/16 in    | 177 mm   | 1 TAH111Z-9/16    |
| 5/8 in     | 195 mm   | 1 TAH111Z-5/8     |
| 11/16 in   | 200 mm   | 1 TAH111Z-11/16   |
| 3/4 in     | 218 mm   | 1 TAH111Z-3/4     |
| 13/16 in   | 250 mm   | 1 TAH111Z-13/16   |
| 7/8 in     | 250 mm   | 1 TAH111Z-7/8     |
| 15/16 in   | 270 mm   | 1 TAH111Z-15/16   |
| 1 in       | 290 mm   | 1 TAH111Z-1       |
| 1-1/16 in  | 310 mm   | 1 TAH111Z-1.1/16  |
| 1-1/8 in   | 310 mm   | 1 TAH111Z-1.1/8   |
| 1-1/4 in   | 350 mm   | 1 TAH111Z-1.1/4   |
| 1-5/16 in  | 350 mm   | 1 TAH111Z-1.5/16  |
| 1 3/8 in   | 410 mm   | 1 TAH111Z-1.3/8   |
| 1 7/16 in  | 410 mm   | 1 TAH111Z-1.7/16  |
| 1 1/2 in   | 410 mm   | 1 TAH111Z-1.1/2   |
| 1 5/8 in   | 460 mm   | 1 TAH111Z-1.5/8   |
| 1 11/16 in | 460 mm   | 1 TAH111Z-1.11/16 |
| 1 3/4 in   | 500 mm   | 1 TAH111Z-1.3/4   |
| 1 13/16 in | 500 mm   | 1 TAH111Z-1.13/16 |
| 1 7/8 in   | 540 mm   | 1 TAH111Z-1.7/8   |
| 2 in       | 540 mm   | 1 TAH111Z-2       |
| 2 1/4 in   | 600 mm   | 1 TAH111Z-2.1/4   |
| 2 3/8 in   | 600 mm   | 1 TAH111Z-2.3/8   |
| 2 5/8 in   | 680 mm   | 1 TAH111Z-2.5/8   |
| 2 3/4 in   | 680 mm   | 1 TAH111Z-2.3/4   |
| 2 7/8 in   | 730 mm   | 1 TAH111Z-2.7/8   |
| 3 in       | 730 mm   | 1 TAH111Z-3       |

Ratcheting Combination Wrenches with Safety Spring



### TAH1RM



| Length | Quantity | Part Number |
|--------|----------|-------------|
| 6 mm   | 128 mm   | 1 TAH1RM-6  |
| 7 mm   | 140 mm   | 1 TAH1RM-7  |
| 8 mm   | 140 mm   | 1 TAH1RM-8  |
| 9 mm   | 150 mm   | 1 TAH1RM-9  |
| 10 mm  | 159 mm   | 1 TAH1RM-10 |
| 11 mm  | 165 mm   | 1 TAH1RM-11 |
| 12 mm  | 172 mm   | 1 TAH1RM-12 |
| 13 in  | 178 mm   | 1 TAH1RM-13 |
| 14 in  | 191 mm   | 1 TAH1RM-14 |
| 15 in  | 200 mm   | 1 TAH1RM-15 |
| 16 in  | 208 mm   | 1 TAH1RM-16 |
| 17 mm  | 226 mm   | 1 TAH1RM-17 |
| 18 in  | 237 mm   | 1 TAH1RM-18 |
| 19 mm  | 248 mm   | 1 TAH1RM-19 |
| 21 in  | 290 mm   | 1 TAH1RM-21 |
| 22 in  | 361 mm   | 1 TAH1RM-22 |
| 24 mm  | 323 mm   | 1 TAH1RM-24 |
| 27 in  | 359 mm   | 1 TAH1RM-27 |
| 30 mm  | 400 mm   | 1 TAH1RM-30 |
| 32 in  | 425 mm   | 1 TAH1RM-32 |



Metric Deep Offset Double Ring End Spanners with Chrome Finish with Stainless Steel Sliding Spring



**TAH2M**



| 6x7 mm   | 165 mm | 1 | TAH2M-6-7   |
|----------|--------|---|-------------|
| 8x9 mm   | 180 mm | 1 | TAH2M-8-9   |
| 10x11 mm | 190 mm | 1 | TAH2M-10-11 |
| 12x13 mm | 210 mm | 1 | TAH2M-12-13 |
| 14x15 mm | 226 mm | 1 | TAH2M-14-15 |
| 16x17 mm | 246 mm | 1 | TAH2M-16-17 |
| 18x19 mm | 266 mm | 1 | TAH2M-18-19 |

Metric Double Open End Wrenches with Safety Spring



**TAH6M**



| 6x7 mm   | 122 mm | 1 | TAH6M-6-7   |
|----------|--------|---|-------------|
| 8x9 mm   | 135 mm | 1 | TAH6M-8-9   |
| 10x11 mm | 153 mm | 1 | TAH6M-10-11 |
| 12x13 mm | 164 mm | 1 | TAH6M-12-13 |
| 14x15 mm | 183 mm | 1 | TAH6M-14-15 |
| 16x17 mm | 201 mm | 1 | TAH6M-16-17 |
| 17x19 mm | 222 mm | 1 | TAH6M-17-19 |
| 18x19 mm | 222 mm | 1 | TAH6M-18-19 |
| 20x22 mm | 225 mm | 1 | TAH6M-20-22 |
| 24x27 mm | 260 mm | 1 | TAH6M-24-27 |
| 30x32 mm | 300 mm | 1 | TAH6M-30-32 |

Flare Nut Wrenches with Safety Spring



**TAH1949M**



| 8x9 mm   | 140 mm | 1 | TAH1949M-8-9   |
|----------|--------|---|----------------|
| 10x11 mm | 150 mm | 1 | TAH1949M-10-11 |
| 12x14 mm | 170 mm | 1 | TAH1949M-12-14 |
| 14x17 mm | 200 mm | 1 | TAH1949M-14-17 |
| 19x22 mm | 220 mm | 1 | TAH1949M-19-22 |
| 24x27 mm | 255 mm | 1 | TAH1949M-24-27 |

Ring End Slogging Wrenches with D-Shackle



**TAH7444SG**



| 36 mm | 205 mm | 1 | TAH7444SG-M-36 |
|-------|--------|---|----------------|
| 41 mm | 230 mm | 1 | TAH7444SG-M-41 |
| 46 mm | 240 mm | 1 | TAH7444SG-M-46 |
| 50 mm | 255 mm | 1 | TAH7444SG-M-50 |
| 55 mm | 270 mm | 1 | TAH7444SG-M-55 |

Metric Double Head Offset Socket Spanners with 6 x 6-Point Dynamic Drive™ with Stainless Steel Ring



**TAH29**



| 12 mm |  | 1 | TAH29M-12 |
|-------|--|---|-----------|
| 6 mm  |  | 1 | TAH29M-6  |
| 7 mm  |  | 1 | TAH29M-7  |
| 8 mm  |  | 1 | TAH29M-8  |
| 10 mm |  | 1 | TAH29M-10 |



|       |  |   |           |
|-------|--|---|-----------|
| 9 mm  |  | 1 | TAH29M-9  |
| 11 mm |  | 1 | TAH29M-11 |
| 13 mm |  | 1 | TAH29M-13 |
| 14 mm |  | 1 | TAH29M-14 |
| 15 mm |  | 1 | TAH29M-15 |
| 16 mm |  | 1 | TAH29M-16 |
| 17 mm |  | 1 | TAH29M-17 |
| 18 mm |  | 1 | TAH29M-18 |
| 19 mm |  | 1 | TAH29M-19 |
| 20 mm |  | 1 | TAH29M-20 |
| 21 mm |  | 1 | TAH29M-21 |
| 22 mm |  | 1 | TAH29M-22 |
| 23 mm |  | 1 | TAH29M-23 |
| 24 mm |  | 1 | TAH29M-24 |
| 25 mm |  | 1 | TAH29M-25 |
| 26 mm |  | 1 | TAH29M-26 |
| 27 mm |  | 1 | TAH29M-27 |
| 28 mm |  | 1 | TAH29M-28 |
| 29 mm |  | 1 | TAH29M-29 |
| 30 mm |  | 1 | TAH29M-30 |
| 32 mm |  | 1 | TAH29M-32 |

Switch Cabinet Wrenches with Dyneema Ready to Work at Height



**TAHMK5**



| 97x25 mm |  | 1 | TAHMK5 |
|----------|--|---|--------|

Ratchet Wrenches with Safety Ring and Dee Shackle



**TAHSC2RM**



| 13-17 mm | 280 mm | 1 | TAHSC2RM-13-17 |
|----------|--------|---|----------------|
| 15-17 mm | 280 mm | 1 | TAHSC2RM-15-17 |
| 19-22 mm | 310 mm | 1 | TAHSC2RM-19-22 |
| 27-30 mm | 450 mm | 1 | TAHSC2RM-27-30 |

## PIPE WRENCHES

ERGO™ Swedish Model Pipe Wrenches with Wire Loop



ergo



### TAH1410-TAH1420



|        |          |   |         |
|--------|----------|---|---------|
| 320 mm | 1 in     | 1 | TAH1410 |
| 430 mm | 1 1/2 in | 1 | TAH1420 |

Swedish Model 90° Pipe Wrenches with Bow Shackle



### TAH14



|        |          |   |        |
|--------|----------|---|--------|
| 210 mm | 3/4 in   | 1 | TAH140 |
| 320 mm | 1 in     | 1 | TAH141 |
| 426 mm | 1 1/2 in | 1 | TAH142 |
| 557 mm | 2-1/2 in | 1 | TAH143 |

Aluminium Pipe Wrenches with Quick Link



### TAH380



|        |          |   |           |
|--------|----------|---|-----------|
| 253 mm | 1.1/2 in | 1 | TAH380-10 |
| 354 mm | 2 in     | 1 | TAH380-14 |
| 455 mm | 2.1/2 in | 1 | TAH380-18 |
| 607 mm | 3 in     | 1 | TAH380-24 |

## SOCKETS & RATCHETS

1/4" Square Drive Sockets with Metric Hex Profile and 4 point solution



### TAH08

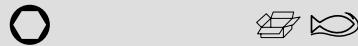

|        |   |           |
|--------|---|-----------|
| 5.5 mm | 1 | TAH08-5.5 |
| 6 mm   | 1 | TAH08-6   |
| 7 mm   | 1 | TAH08-7   |
| 8 mm   | 1 | TAH08-8   |
| 9 mm   | 1 | TAH08-9   |
| 10 mm  | 1 | TAH08-10  |
| 11 mm  | 1 | TAH08-11  |
| 12 mm  | 1 | TAH08-12  |
| 13 mm  | 1 | TAH08-13  |

1/4" Square Drive Breaker Bars with Safety Spring



### TAH6958B-1

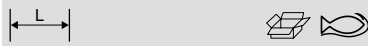

|        |   |            |
|--------|---|------------|
| 150 mm | 1 | TAH6958B-1 |
|--------|---|------------|

1/4" Square Drive Extension Bars with 4 Holes



### TAH6960-TAH6962L



|        |   |          |
|--------|---|----------|
| 50 mm  | 1 | TAH6960  |
| 101 mm | 1 | TAH6961  |
| 152 mm | 1 | TAH6962  |
| 355 mm | 1 | TAH6962L |

1/4" Square Drive Universal Joints with 4 Holes



### TAH6966

|       |   |         |
|-------|---|---------|
| 36 mm | 1 | TAH6966 |
|-------|---|---------|

1/4" Square Drive Socket Drivers for Metric Hex Head Screws with 4 Points Solution



### TAH08-H

|      |   |          |
|------|---|----------|
| 3 mm | 1 | TAH08-H3 |
| 4 mm | 1 | TAH08-H4 |
| 5 mm | 1 | TAH08-H5 |
| 6 mm | 1 | TAH08-H6 |
| 8 mm | 1 | TAH08-H8 |

1/4" Square Drive Socket Drivers for Phillips Head Screws with 4 Points Solution



### TAH08-PH

|   |   |           |
|---|---|-----------|
| 1 | 1 | TAH08-PH1 |
| 2 | 1 | TAH08-PH2 |
| 3 | 1 | TAH08-PH3 |





1/4" Square Drive Socket Drivers for TORX® Head Screws with 4 Points Solution



**TAH08TTAH**



| T-8  | 1 TAH08-T8  |
|------|-------------|
| T-9  | 1 TAH08-T9  |
| T-10 | 1 TAH08-T10 |
| T-15 | 1 TAH08-T15 |
| T-20 | 1 TAH08-T20 |
| T-25 | 1 TAH08-T25 |
| T-27 | 1 TAH08-T27 |
| T-30 | 1 TAH08-T30 |
| T-40 | 1 TAH08-T40 |

1/4" Square Drive Reversible Ratchets with Sealed Dyneema String



**TAH6950**



| 120 mm | 1 TAH6950 |
|--------|-----------|

1/4" Square Drive Spinner Handles with Safety Chuck



**TAH6956-1**



| 150 mm | 1 TAH6956-1 |
|--------|-------------|

1/2" Square Drive Sockets with Metric Bi-Hex Profile and 4 Point Solution



**TAH16B**



| 8 mm  | 1 TAH16B-8  |
|-------|-------------|
| 10 mm | 1 TAH16B-10 |
| 11 mm | 1 TAH16B-11 |
| 12 mm | 1 TAH16B-12 |
| 13 mm | 1 TAH16B-13 |
| 14 mm | 1 TAH16B-14 |
| 15 mm | 1 TAH16B-15 |
| 16 mm | 1 TAH16B-16 |
| 17 mm | 1 TAH16B-17 |
| 18 mm | 1 TAH16B-18 |
| 19 mm | 1 TAH16B-19 |
| 21 mm | 1 TAH16B-21 |
| 22 mm | 1 TAH16B-22 |
| 24 mm | 1 TAH16B-24 |
| 25 mm | 1 TAH16B-25 |
| 27 mm | 1 TAH16B-27 |
| 30 mm | 1 TAH16B-30 |
| 32 mm | 1 TAH16B-32 |

1/2" Square Drive Sockets with Imperial Bi-Hex Profile and 4 Point Solution



**TAH16B"**



| 1/2 in    | 1 TAH16B-1/2    |
|-----------|-----------------|
| 9/16 in   | 1 TAH16B-9/16   |
| 5/8 in    | 1 TAH16B-5/8    |
| 11/16 in  | 1 TAH16B-11/16  |
| 3/4 in    | 1 TAH16B-3/4    |
| 13/16 in  | 1 TAH16B-13/16  |
| 7/8 in    | 1 TAH16B-7/8    |
| 15/16 in  | 1 TAH16B-15/16  |
| 1 in      | 1 TAH16B-1      |
| 1 1/16 in | 1 TAH16B-1.1/16 |
| 1 1/8 in  | 1 TAH16B-1.1/8  |
| 1 1/4 in  | 1 TAH16B-1.1/4  |

1/2" Breaker Bars with Safety Spring



**TAH8158B-1**



| 256 mm | 1 TAH8158B-1 |
|--------|--------------|

1/2" Extension Bars with 4 Holes



**TAH8160-8162**

| 125 mm | 1 TAH8160 |
|--------|-----------|
| 250 mm | 1 TAH8162 |

1/2" Universal Joints with 4 Point Solution



**TAH8166**

| 67 mm | 1 TAH8166 |
|-------|-----------|

1/2" Square Drive Socket Drivers for Metric Hex Head Screws with 4 point solution



**TAH16H**

| 4 mm  | 1 TAH16-H4  |
|-------|-------------|
| 5 mm  | 1 TAH16-H5  |
| 6 mm  | 1 TAH16-H6  |
| 7 mm  | 1 TAH16-H7  |
| 8 mm  | 1 TAH16-H8  |
| 10 mm | 1 TAH16-H10 |
| 12 mm | 1 TAH16-H12 |
| 14 mm | 1 TAH16-H14 |
| 17 mm | 1 TAH16-H17 |
| 19 mm | 1 TAH16-H19 |

1/2" Square Drive Socket Drivers for Imperial Hex Head Screws with 4 point solution



**TAH16H"**

| 1/4 in  | 1 TAH16H-1/4  |
|---------|---------------|
| 5/16 in | 1 TAH16H-5/16 |
| 3/8 in  | 1 TAH16H-3/8  |
| 7/16 in | 1 TAH16H-7/16 |
| 1/2 in  | 1 TAH16H-1/2  |
| 9/16 in | 1 TAH16H-9/16 |
| 5/8 in  | 1 TAH16H-5/8  |

1/2" Square Drive Socket Drivers for TORX® Head Screws with 4 Points Solution



**TAH16-T**

| T30 | 1 TAH16-T30 |
|-----|-------------|
| T40 | 1 TAH16-T40 |
| T45 | 1 TAH16-T45 |



|     |             |
|-----|-------------|
| T50 | 1 TAH16-T50 |
| T55 | 1 TAH16-T55 |
| T60 | 1 TAH16-T60 |

1/2" Reversible Ratchets with Sealed Dyneema String



**TAH8150-1/2**

| <br>270 mm | 1 TAH8150-1/2 |
|------------|---------------|

1/2" Square Drive Socket Set with Metric Hex Profile and Pear Head Ratchet - 22 pcs for Working at Height



**TAH16BM/22**

| 85 x 350 x 445 mm | 1 TAH16BM/22 |
|-------------------|--------------|

1/2" Square Drive Socket Set with Imperial Hex Profile and Pear Head Ratchet - 17 pcs for Working at Height



**TAH16BZ/17**

| 80 x 300 x 380 mm | 1 TAH16BZ/17 |
|-------------------|--------------|

3/4" Square Drive Sockets with Metric Hex Profile and 4 point solution



**TAH24B**

| 27 mm | 1 TAH24B-27 |
|-------|-------------|
| 30 mm | 1 TAH24B-30 |
| 32 mm | 1 TAH24B-32 |
| 36 mm | 1 TAH24B-36 |
| 38 mm | 1 TAH24B-38 |
| 41 mm | 1 TAH24B-41 |
| 46 mm | 1 TAH24B-46 |
| 50 mm | 1 TAH24B-50 |

3/4" Square Drive Extension Bars with 4 Point Solution



**TAH8961**

| <br>200 mm | 1 TAH8961 |
|------------|-----------|

3/4" Square Drive Universal Handles with Loop Wire



**TAH8953**

| <br>500 mm | 1 TAH8953 |
|------------|-----------|



3/4" Square Drive Reversible Ratchet Heads with Loop Wire



**TAHE8950N/A**



|        |               |  |
|--------|---------------|--|
|        |               |  |
| 170 mm | 1 TAHE8950N/A |  |

Stubby Pin Releasers for TAH Sockets



**TAHPINRELEASER**



|      |       |                  |
|------|-------|------------------|
|      |       |                  |
| 4 mm | 45 mm | 1 TAHPINRELEASER |

**SCREWDRIVERS**

ERGO™ Slotted Screwdrivers with Safety Chuck



**TAHE8020L-TAHE8252**



|        |        |              |
|--------|--------|--------------|
|        |        |              |
| 3.2 mm | 75 mm  | 1 TAHE-8020L |
| 3.5 mm | 75 mm  | 1 TAHE-8030  |
| 4 mm   | 100 mm | 1 TAHE-8040  |
| 5.5 mm | 150 mm | 1 TAHE-8241  |
| 6.5 mm | 150 mm | 1 TAHE-8252  |

ERGO™ Slotted Screwdrivers with Dyneema String



**TAHE8155**



|       |        |             |
|-------|--------|-------------|
|       |        |             |
| 6 mm  | 125 mm | 1 TAHE-8155 |
| 8 mm  | 175 mm | 1 TAHE-8257 |
| 10 mm | 210 mm | 1 TAHE-8258 |

ERGO™ Bolster Screwdrivers for Slotted Head Screws with Dyneema String



**TAHE8260**



|       |        |             |
|-------|--------|-------------|
|       |        |             |
| 9 mm  | 175 mm | 1 TAHE-8260 |
| 12 mm | 200 mm | 1 TAHE-8880 |

ERGO™ Stubby Screwdrivers for Slotted Head Screws with Safety Chuck



**TAHE8350**



|        |       |             |
|--------|-------|-------------|
|        |       |             |
| 5.5 mm | 28 mm | 1 TAHE-8350 |

ERGO™ Screwdrivers for Phillips Head Screws with Safety Chuck



**TAHE8610-TAHE8624**



|      |        |              |
|------|--------|--------------|
|      |        |              |
| PH 1 | 75 mm  | 1 TAHE-8611  |
| PH 1 | 75 mm  | 1 TAHE-8610  |
| PH 2 | 100 mm | 1 TAHE-8620  |
| PH 2 | 200 mm | 1 TAHE-8620L |
| PH 3 | 150 mm | 1 TAHE-8623  |
| PH 4 | 190 mm | 1 TAHE-8624  |

ERGO™ Bolster Screwdrivers for Phillips Head Screws with Dyneema String



**TAHE8630**



|      |        |             |
|------|--------|-------------|
|      |        |             |
| PH 3 | 155 mm | 1 TAHE-8630 |

ERGO™ Stubby Screwdrivers for Phillips Head Screws with Safety Chuck



**TAHE8602**



|     |       |             |
|-----|-------|-------------|
|     |       |             |
| PH2 | 30 mm | 1 TAHE-8602 |

ERGO™ Screwdrivers for Pozidriv Head Screws with Safety Chuck



**TAHBE8810-TAHBE8820**



|      |        |   |            |
|------|--------|---|------------|
|      |        |   |            |
| PZ 1 | 73 mm  | 1 | TAHBE-8810 |
| PZ 2 | 100 mm | 1 | TAHBE-8820 |

ERGO™ Insulated Slotted Screwdrivers with Kevlar String



**TAHBE8040S-TAHBE8050S**



|        |        |   |             |
|--------|--------|---|-------------|
|        |        | 1 | TAHBE-8220S |
| 3.0 mm | 100 mm | 1 | TAHBE-8040S |
| 4.0 mm | 100 mm | 1 | TAHBE-8050S |
| 5.5 mm | 125 mm | 1 | TAHBE-8255S |
| 6.5 mm | 155 mm | 1 | TAHBE-8255S |

ERGO™ Slim VDE Insulated Pozidriv Screwdrivers with 3-Component Handle with Kevlar Cord



**TAHBE-8820SL**



|      |      |   |              |
|------|------|---|--------------|
| PZ 2 | PZ 2 | 1 | TAHBE-8820SL |
|------|------|---|--------------|

ERGO™ Bolster Screwdrivers for Pozidriv Head Screws with Dyneema String



**TAHBE-8830**



|      |        |   |            |
|------|--------|---|------------|
|      |        |   |            |
| PZ 3 | 150 mm | 1 | TAHBE-8830 |

ERGO™ Insulated Phillips Screwdrivers with Kevlar String



**TAHBE8610S-TAHBE8620S**



|     |        |   |             |
|-----|--------|---|-------------|
|     |        | 1 | TAHBE-8610S |
| PH1 | 80 mm  | 1 | TAHBE-8620S |
| PH2 | 100 mm | 1 | TAHBE-8630S |
| PH3 | 150 mm | 1 | TAHBE-8640S |
| PH4 | 190 mm | 1 | TAHBE-8640S |

Slotted Screwdrivers with Precision Grip 0.18–0.8 mm with Stainless Steel Ring



**TAH700**



|        |        |   |               |
|--------|--------|---|---------------|
|        |        | 1 | TAH700-1.5-50 |
| 1.5 mm | 137 mm | 1 | TAH700-1.8-50 |
| 1.8 mm | 137 mm | 1 | TAH700-2.5-50 |
| 2.5 mm | 137 mm | 1 | TAH700-3-100  |
| 3 mm   | 187 mm | 1 | TAH700-3-100  |

ERGO™ Screwdrivers for TORX® Head Screws with Safety Chuck



**TAHBE8910-TAHBE8930**



|     |         |   |            |
|-----|---------|---|------------|
|     |         |   |            |
| T10 | 2.72 mm | 1 | TAHBE-8910 |
| T15 | 3.26 mm | 1 | TAHBE-8915 |
| T20 | 3.84 mm | 1 | TAHBE-8920 |
| T25 | 4 mm    | 1 | TAHBE-8925 |
| T30 | 6 mm    | 1 | TAHBE-8930 |

ERGO™ Insulated TORX® Head Screwdrivers with Kevlar String



**TAHBE8910S-TAHBE8930S**



|     |         |   |             |
|-----|---------|---|-------------|
|     |         | 1 | TAHBE-8910S |
| T10 | 2.5 mm  | 1 | TAHBE-8915S |
| T15 | 3.26 mm | 1 | TAHBE-8920S |
| T20 | 3.84 mm | 1 | TAHBE-8925S |
| T25 | 4.4 mm  | 1 | TAHBE-8930S |
| T30 | 5.49 mm | 1 | TAHBE-8930S |

Phillips Screwdrivers with Precision Grip PH00-PH1 with Stainless Steel Ring



**TAH701**

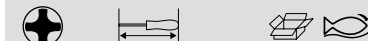

|      |        |   |              |
|------|--------|---|--------------|
|      |        | 1 | TAH701-00-50 |
| PH00 | 137 mm | 1 | TAH701-0-50  |
| PH 0 | 137 mm | 1 | TAH701-0-50  |





Torx® Screwdrivers with Precision Grip T4-T20 with Stainless Steel Ring



**TAH703**



| Size | Length | Qty | Part No.     |
|------|--------|-----|--------------|
| T 6  | 137 mm | 1   | TAH703-6-50  |
| T 7  | 137 mm | 1   | TAH703-7-50  |
| T 8  | 137 mm | 1   | TAH703-8-50  |
| T 9  | 137 mm | 1   | TAH703-9-50  |
| T 10 | 137 mm | 1   | TAH703-10-50 |
| T 15 | 162 mm | 1   | TAH703-15-75 |

Metric Hex Folding L-Key Set with Phosphate Finish 1.5–6 mm - 7 pcs with Kevlar Textile Wire Loop



**TAHBE-9776**



| Size                       | Length | Qty | Part No.   |
|----------------------------|--------|-----|------------|
| 1.5, 2, 2.5, 3, 4, 5, 6 mm |        | 1   | TAHBE-9776 |

Double Offset Keys for Slotted Screws with Steel Wire



**TAH2047**



| Size   | Length | Qty | Part No.      |
|--------|--------|-----|---------------|
| 4.0 mm | 100 mm | 1   | TAH2047-0.8-4 |

Metric Hex L-Keys with Phosphate Finish with Stainless Steel Ring



**TAH1995M**



| Size  | Length | Qty | Part No.    |
|-------|--------|-----|-------------|
| 8 mm  | 108 mm | 1   | TAH1995M-8  |
| 10 mm | 122 mm | 1   | TAH1995M-10 |
| 12 mm | 137 mm | 1   | TAH1995M-12 |

Metric Offset Screwdriver Hex Key Folders with Kevlar String - 7 Pcs



**TAHBE-9777B**



| Size                      | Length | Qty | Part No.    |
|---------------------------|--------|-----|-------------|
| 2.5, 3, 4, 5, 6, 8, 10 mm |        | 1   | TAHBE-9777B |

Double Offset Keys for Phillips Screws with Steel Wire



**TAH2047PR**



| Size     | Length | Qty | Part No.      |
|----------|--------|-----|---------------|
| PH 1 & 2 | 100 mm | 1   | TAH2047PR-1-2 |

Imperial Hex L-Keys with Phosphate Finish with Stainless Steel Ring



**TAH1995Z**



| Size   | Length | Qty | Part No.     |
|--------|--------|-----|--------------|
| 1/2 in | 145 mm | 1   | TAH1995Z-1/2 |

Imperial Offset Screwdriver Hex Key Folders with Insert Plate - 7 Pcs



**TAHBE-9787**



| Size                                     | Length | Qty | Part No.   |
|--|--------|-----|------------|
| 3/32, 1/8, 5/32, 3/16, 1/4, 5/16, 3/8 in |        | 1   | TAHBE-9787 |

**PLIERS**

ERGO™ Side Cutting Pliers with Safety Ring



**TAH2101G**



| Length | Qty | Part No.      |
|--------|-----|---------------|
| 130 mm | 1   | TAH2101G-125  |
| 145 mm | 1   | TAH2101G-140  |
| 165 mm | 1   | TAH2101G-160  |
| 185 mm | 1   | TAH2101G-180  |
| 125 mm | 1   | TAH2101G-125C |
| 145 mm | 1   | TAH2101G-140C |
| 165 mm | 1   | TAH2101G-160C |
| 180 mm | 1   | TAH2101G-180C |

ERGO™ Heavy Duty Side Cutting Pliers with Safety Ring



ergo



**TAH21HDG**

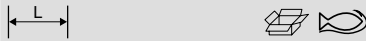

|        |   |               |
|--------|---|---------------|
| 210 mm | 1 | TAH21HDG-200  |
| 200 mm | 1 | TAH21HDG-200C |

ERGO™ Snipe Nose Pliers with Safety Ring



ergo



**TAH2430G**

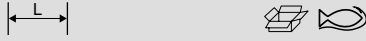

|        |   |              |
|--------|---|--------------|
| 160 mm | 1 | TAH2430G-160 |
| 200 mm | 1 | TAH2430G-200 |

Ratcheting Crimping Pliers for Insulated Connectors with Fixed Metallic Wire Loop



**TAHCRW01**

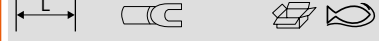

|        |                         |   |          |
|--------|-------------------------|---|----------|
| 225 mm | 0.5-6.0 mm <sup>2</sup> | 1 | TAHCRW01 |
|--------|-------------------------|---|----------|

ERGO™ Combination Pliers with Safety Ring



ergo



**TAH2628G**

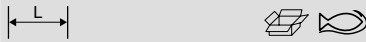

|        |   |              |
|--------|---|--------------|
| 170 mm | 1 | TAH2628G-160 |
| 190 mm | 1 | TAH2628G-180 |
| 200 mm | 1 | TAH2628G-200 |

ERGO™ Snipe Nose Pliers with 45° Bent Tips and Safety Ring



ergo



**TAH2427G**

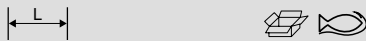

|        |   |              |
|--------|---|--------------|
| 200 mm | 1 | TAH2427G-200 |
|--------|---|--------------|

Internal Circlip Pliers with Straight Jaws and Phosphate Finish with Stainless Steel Ring



**TAH2800**

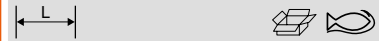

|        |   |             |
|--------|---|-------------|
| 150 mm | 1 | TAH2800-150 |
| 180 mm | 1 | TAH2800-180 |

2 Position Combination Pliers with Safety Ring



**TAH2970G**



|        |   |              |
|--------|---|--------------|
| 200 mm | 1 | TAH2970G-200 |
|--------|---|--------------|

ERGO™ Wire Stripping Pliers with Safety Ring



ergo



**TAH2223G-150**

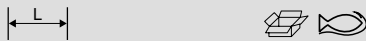

|        |   |              |
|--------|---|--------------|
| 167 mm | 1 | TAH2223G-150 |
|--------|---|--------------|

External Circlip Pliers with Straight Jaws and Phosphate Finish with Stainless Steel Ring



**TAH2900**

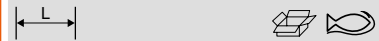

|        |   |             |
|--------|---|-------------|
| 180 mm | 1 | TAH2900-180 |
|--------|---|-------------|



TAH Universal grip with curved jaws. 0



**TAH2951**



235 m

1 TAH2951-250

Self Grip Locking Pliers with Curved Jaws with Fixed Metallic Plate



**TAH2953**



140 mm  
300 mm

1 TAH2953-140  
1 TAH2953-300

Grips with Straight Jaws and Insert Plate



**TAH2958**



200 mm  
245 mm

1 TAH2958-200  
1 TAH2958-250

ERGO™ Water Pump Pliers with Safety Ring



ergo



**TAH8224**



250 mm

1 TAH8224

High Leverage Fencing Pliers with Black Epoxy Finish and Safety Ring



**TAH2339**



2.5 mm

250 mm

1 TAH2339-250

Wire Twisting Pliers with Safety Ring



**TAH2855**



232 mm

1 TAH2855

## CUTTING TOOLS

Folding Pruning Saws with Dual-Component Handle with Sealed Dyneema Cord



**TAH396**



190 mm

7 1/2 in

1 TAH396-JT

ERGO™ Professional Hand Hacksaw Frames with Loop Wire



ergo



**TAH325**



300 mm

1 TAH325

Traditional Hand Hacksaw Frames with Loop Wire



**TAH320**



500 mm

1 TAH320

Hacksaw Frames with Loop Wire for All Round Use



**TAH317**

|        |  |   |        |
|--------|--|---|--------|
|        |  |   |        |
| 432 mm |  | 1 | TAH317 |

Aluminium Hand Hacksaw Frames with Loop Wire



**TAH225**

|        |  |   |             |
|--------|--|---|-------------|
|        |  |   |             |
| 310 mm |  | 1 | TAH225-PLUS |

ERGO™ Flat Files with Safety Ring



ergo



**TAH1-100**

|        |   |   |                 |
|--------|---|---|-----------------|
|        |   |   |                 |
| 265 mm | 2 | 1 | TAH1-100-06-2-4 |

ERGO™ Engineering Tapered Edge Flat Files Bastard/Second/Smooth Cut with Permanent Stainless Steel Ring



ergo



**TAH1-110**

|        |   |   |                 |
|--------|---|---|-----------------|
|        |   |   |                 |
| 200 mm | 1 | 1 | TAH1-110-08-1-2 |

ERGO™ Mill Files with 2 Flat Edges and Safety Ring



ergo



**TAH1-143**

|        |   |   |                 |
|--------|---|---|-----------------|
|        |   |   |                 |
| 415 mm | 1 | 1 | TAH1-143-12-1-2 |

ERGO™ Engineering Square Files Bastard/Second/Smooth Cut with Permanent Stainless Steel Ring



ergo



**TAH1-160**

|        |   |   |                 |
|--------|---|---|-----------------|
|        |   |   |                 |
| 200 mm | 1 | 1 | TAH1-160-08-1-2 |

ERGO™ Engineering 3 Square Files Bastard/Second/Smooth Cut with Permanent Stainless Steel Ring



ergo



**TAH1-170**

|        |   |   |                 |
|--------|---|---|-----------------|
|        |   |   |                 |
| 200 mm | 1 | 1 | TAH1-170-08-1-2 |

ERGO™ Half-Round Files with Safety Ring



ergo



**TAH1-210**

|        |   |   |                 |
|--------|---|---|-----------------|
|        |   |   |                 |
| 270 mm | 2 | 1 | TAH1-210-06-2-2 |
| 325 mm | 1 | 1 | TAH1-210-08-1-2 |

ERGO™ Round Files with Safety Chuck



ergo



**TAH1-230**

|        |   |   |                 |
|--------|---|---|-----------------|
|        |   |   |                 |
| 260 mm | 2 | 1 | TAH1-230-06-2-2 |
| 310 mm | 1 | 1 | TAH1-230-08-1-2 |

Heavy Duty Electrician Scissors with Wire Loop



**TAHSCB140G**

|        |       |   |            |
|--------|-------|---|------------|
|        |       |   |            |
| 145 mm | 43 mm | 1 | TAHSCB140G |

Electrician Knives with Dyneema String



**TAH2820EF**

|        |       |   |            |
|--------|-------|---|------------|
|        |       |   |            |
| 195 mm | 85 mm | 1 | TAH2820EF2 |





Utility Wire Brushes With Wooden Handle



**TAH52-TAH782-U**



| L      | Weight | Item     |
|--------|--------|----------|
| 150 mm | 1      | TAH52    |
| 290 mm | 1      | TAH782-U |

Ball Pein Hammers with Wire Loop and Hickory Handle



**TAH479**



| Weight | L      | Item        |
|--------|--------|-------------|
| 480 g  | 350 mm | 1 TAH479-16 |
| 900 g  | 400 mm | 1 TAH479-32 |

Safety Sledge Hammers with Wire Loop



**TAH489**



| Weight | L      | Item          |
|--------|--------|---------------|
| 1100 g | 294 mm | 1 TAH489-1100 |
| 1800 g | 300 mm | 1 TAH489-1800 |
| 2700 g | 770 mm | 1 TAH489-2700 |
| 3600 g | 770 mm | 1 TAH489-3600 |
| 4500 g | 797 mm | 1 TAH489-4500 |
| 5400 g | 795 mm | 1 TAH489-5400 |

**HAMMERS, PRY BARS & CHISELS**

Dead Blow Sledge Hammers with Wire Loop and Anti-Sliding Handle



**TAH3625PU**



| Weight | L      | Item           |
|--------|--------|----------------|
| 620 g  | 340 mm | 1 TAH3625PU-50 |

German DIN Hammers with Wire Loop



**TAH481**



| Weight | L      | Item         |
|--------|--------|--------------|
| 300 g  | 300 mm | 1 TAH481-300 |

Ball Pein Hammers with Unbreakable Handle and Fixed Metallic Wire Loop



**TAH490**



| Weight | L      | Item          |
|--------|--------|---------------|
| 700 g  | 340 mm | 1 TAH490-700  |
| 900 g  | 340 mm | 1 TAH490-900  |
| 1100 g | 340 mm | 1 TAH490-1100 |

Nylon Tip Mallets with Wire Loop



**TAH3625PW**



| L      | Item          |
|--------|---------------|
| 300 mm | 1 TAH3625W-35 |

Club Hammers with Wire Loop and Hickory Handle



**TAH484**



| Weight | L      | Item          |
|--------|--------|---------------|
| 1000 g | 260 mm | 1 TAH484-1000 |
| 1500 g | 280 mm | 1 TAH484-1500 |
| 2000 g | 305 mm | 1 TAH484-2000 |

Spanish Type Bricklayer Hammers with Wire Loop



**TAH486F**



| Weight | L      | Item          |
|--------|--------|---------------|
| 700 g  | 330 mm | 1 TAH486F-700 |

Carpenter's Hammer Spike Claw with Tubular Steel Shaft with Wire Loop



**TAH485**



|       |        |          |
|-------|--------|----------|
|       |        |          |
| 600 g | 318 mm | 1 TAH485 |

Bi-Material Parallel Punches with Safety Chuck



**TAH3734BM**



|        |       |                |
|--------|-------|----------------|
|        |       |                |
| 155 mm | 2 mm  | 1 TAH3734BM-2  |
| 155 mm | 3 mm  | 1 TAH3734BM-3  |
| 165 mm | 4 mm  | 1 TAH3734BM-4  |
| 165 mm | 5 mm  | 1 TAH3734BM-5  |
| 185 mm | 6 mm  | 1 TAH3734BM-6  |
| 185 mm | 8 mm  | 1 TAH3734BM-8  |
| 185 mm | 10 mm | 1 TAH3734BM-10 |

Pointed Chisels with Octagonal Shank and Lacquered Copper Finish with Fixed Metallic Wire Loop



**TAH3739**



|        |               |
|--------|---------------|
|        |               |
| 300 mm | 1 TAH3739-300 |

Non-Sparking and Anti-Magnetic Hammers with Aluminium Bronze Shackle



**TAH487**



|        |        |               |
|--------|--------|---------------|
|        |        |               |
| 4500 g | 895 mm | 1 TAH487-5200 |

Bi-Material Centre Punches with Safety Chuck



**TAH3755BM**



|        |      |               |
|--------|------|---------------|
|        |      |               |
| 165 mm | 4 mm | 1 TAH3755BM-4 |

Pry Bars with PVC Handle and Safety Ring



**TAH2484**



|        |              |
|--------|--------------|
|        |              |
| 305 mm | 1 TAH2484-30 |

TAH Special steel hexagonal bar



**TAHWBB**



|        |             |
|--------|-------------|
|        |             |
| 595 mm | 1 TAHWBB600 |
| 680 mm | 1 TAHWBB700 |

Cold Chisels with Safety Ring



**TAH3640**



|        |                 |
|--------|-----------------|
|        |                 |
| 250 mm | 1 TAH3640-250-C |

Cam Pry Bars with Bow Shackle



**TAH3683**



|        |           |
|--------|-----------|
|        |           |
| 400 mm | 1 TAH3683 |



Rolling Head Pry Bars with Phosphated Body with Fixed Metallic Wire Loop



**TAH3681**



|        |   |            |
|--------|---|------------|
| 304 mm | 1 | TAH3681-11 |
| 406 mm | 1 | TAH3681-16 |
| 503 mm | 1 | TAH3681-20 |

Scaffold Levels with Dyneema String



**TAH466**



|        |   |            |
|--------|---|------------|
| 250 mm | 1 | TAH466-250 |
|--------|---|------------|

Squares with Dyneema String



**TAH9045-B-250**



|        |        |   |               |
|--------|--------|---|---------------|
| 250 mm | 170 mm | 1 | TAH9045-B-250 |
|--------|--------|---|---------------|

## MEASURING & LAYOUT

Long Measuring Tapes with Nylon Coated Blade and Open Case with Dyneema Textile Wire Loop



**TAHLTS**



|      |       |   |           |
|------|-------|---|-----------|
| 30 m | 13 mm | 1 | TAHLTS-30 |
|------|-------|---|-----------|

Combination Squares with Dyneema String



**TAHCS300**



|        |        |   |          |
|--------|--------|---|----------|
| 300 mm | 125 mm | 1 | TAHCS300 |
|--------|--------|---|----------|

Callipers with Safety Ring



**TAH1150**



|                 |   |                |
|-----------------|---|----------------|
| 7 x 75 x 235 mm | 1 | TAH1150-1/2H/P |
|-----------------|---|----------------|

Metric Stainless Steel Rulers with Dyneema Textile Wire Loop



**TAHSR300**



|        |   |             |
|--------|---|-------------|
| 300 mm | 1 | TAHSR300-MM |
|--------|---|-------------|

Carpenter Squares with Dyneema String



**TAH9048-250**



|        |        |   |             |
|--------|--------|---|-------------|
| 250 mm | 165 mm | 1 | TAH9048-250 |
|--------|--------|---|-------------|

Offset Scribes with Wire Loop



**TAH1177**



|      |   |                |
|------|---|----------------|
| 30 g | 1 | TAH1177-SCRIBE |
|------|---|----------------|

Professional Feeler Gauges with Safety Ring



**TAH1544**



105 mm

1 TAH1544

Mechanical Torque Wrenches with Wire Loop



**TAH7455**

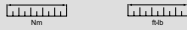

60-300 N·m 44.3-221.3 lbf·ft

1 TAH7455-300-1

Reversible Ratchet Insert Tools with Safety Pin Locking Mechanism



**TAH7852-1**



14X18 mm

1/2"

1 TAH7852-1

**TORQUE TOOLS**

Mechanical Adjustable Torque Click Wrench with Marked Scale and Fixed Ratchet Head with Metallic Plate



**TAH73R**



1/2" 20-100 N·m  
1/2" 40-200 N·m  
1/2" 60-300 N·m

1 TAH73R-100  
1 TAH73R-200  
1 TAH73R-300

Torque Wrenches with Interchangeable Head and Wire Loop



**TAH74W9**



20-100 N·m 9x12 mm

1 TAH74W9-100

Torque Wrenches with Fixed Ratchet Head and Wire Loop



**TAH7445**



20-100 N·m 1/2 in

1 TAH7445-100A-1

Reversible Ratchet Head Inserts with Locking Device



**TAH7452-2**

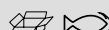

9x12 mm

1/2"

1 TAH7452-2

**CLAMPING TOOLS**

F-Clamps with Safety Bow Shackle



**TAH420SH-80-160**



160 mm

80 mm

1 TAH420SH-80-160

**OTHER TOOLS**

Carbon Scrapers with Safety Spring



**TAH2487**

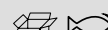

205 mm

1 TAH2487





Miniature Awls/Hooks/Picks Tool Set with Kevlar Textile Wire Loop



**TAH2633**



146 g



1 TAH2633/S4

Chain Oil Filter Wrenches with D-shackle



**TAHBE64520**



520 mm



60-160 mm



1 TAHBE64520

Flexible Pick-up Tools with Wire Loop



**TAH2509**



560 mm



1 TAH2509

Head Torches with Dyneema String



**TAHBFRL11**



90 x 95 x 115 mm



1 TAHBFRL11

ERGO™ Magnetic Pick-ups with Dyneema String



ergo



**TAH2535F2**



13 mm



405 mm



1 TAH2535F2

Grease Pumps with Quick Link



**TAHBOD54**



120 x 385 x 57 mm

135 x 400 x 61 mm



1 TAHBOD5400

1 TAHBOD5450

## GLOVES

General Purpose Gloves with Absorption Pad



**GL008**



8  
10



5 GL008-8  
5 GL008-10

General Purpose Synthetic Leather Gloves



**3875-GLOVE**



9



67 g



5 3875-GLOVE

Power Tool Gloves with Absorption Pad and Anti-Vibration Pad



**GL010**



8  
10



5 GL010-8  
5 GL010-10



## Insulated Tools



## SCREWDRIVERS

ERGO™ VDE Insulated Slotted Screwdrivers with 3-Component Handle 2.5 mm-12 mm



### BE-8010S - BE-8065S

| Tip Size | Length | Quantity | Part No. |
|----------|--------|----------|----------|
| 2.5 mm   | 75 mm  | 5        | BE-8010S |
| 3.0 mm   | 100 mm | 5        | BE-8220S |
| 3.5 mm   | 100 mm | 5        | BE-8230S |
| 4.0 mm   | 100 mm | 5        | BE-8040S |
| 5.5 mm   | 125 mm | 5        | BE-8050S |
| 6.5 mm   | 150 mm | 5        | BE-8255S |
| 8.0 mm   | 175 mm | 5        | BE-8065S |
| 10 mm    | 200 mm | 5        | BE-8258S |
| 12 mm    | 200 mm | 5        | BE-8259S |

ERGO™ VDE Insulated Phillips Screwdrivers with 3-Component Handle PH0-PH4



### BE-8600S - BE-8640S

| Tip Size | Length | Quantity | Part No. |
|----------|--------|----------|----------|
| PH 0     | 75 mm  | 5        | BE-8600S |
| PH 1     | 80 mm  | 5        | BE-8610S |
| PH1      | 80 mm  | 5        | BE-8611S |
| PH 1     | 150 mm | 5        | BE-8612S |
| PH 2     | 100 mm | 5        | BE-8620S |
| PH 2     | 100 mm | 5        | BE-8621S |
| PH 2     | 175 mm | 5        | BE-8622S |
| PH 3     | 150 mm | 5        | BE-8630S |
| PH 4     | 200 mm | 5        | BE-8640S |

ERGO™ VDE Insulated Pozidriv Screwdrivers with 3-Component Handle PZ0-PZ4



### BE-8800S - BE-8840S

| Tip Size | Length | Quantity | Part No. |
|----------|--------|----------|----------|
| PZ 0     | 75 mm  | 5        | BE-8800S |
| PZ 1     | 80 mm  | 5        | BE-8810S |
| PZ1      | 80 mm  | 5        | BE-8811S |
| PZ 1     | 150 mm | 5        | BE-8812S |
| PZ 2     | 100 mm | 5        | BE-8820S |
| PZ 2     | 100 mm | 5        | BE-8821S |
| PZ 2     | 175 mm | 5        | BE-8822S |
| PZ 3     | 150 mm | 5        | BE-8830S |
| PZ 4     | 200 mm | 5        | BE-8840S |

ERGO™ VDE Insulated TORX® Head Screwdrivers with 3-Component Handle T5-T30



### BE-8910S - BE-8930S

| Tip Size | Length | Quantity | Part No. |
|----------|--------|----------|----------|
| T 5      | 75 mm  | 5        | BE-8905S |
| T 6      | 75 mm  | 5        | BE-8906S |
| T 7      | 75 mm  | 5        | BE-8907S |
| T 8      | 75 mm  | 5        | BE-8908S |
| T 9      | 75 mm  | 5        | BE-8909S |
| T 10     | 100 mm | 5        | BE-8910S |
| T 15     | 125 mm | 5        | BE-8915S |
| T 20     | 125 mm | 5        | BE-8920S |
| T 25     | 150 mm | 5        | BE-8925S |
| T 30     | 175 mm | 5        | BE-8930S |

ERGO™ VDE Insulated Hex Socket-Head Screwdrivers with 3-Component Handle 2.5 mm-8 mm



### BE-8725S - BE-8708S

| Tip Size | Length | Quantity | Part No. |
|----------|--------|----------|----------|
| 2.5 mm   | 100 mm | 5        | BE-8725S |
| 3 mm     | 125 mm | 5        | BE-8703S |
| 4 mm     | 150 mm | 5        | BE-8704S |
| 5 mm     | 175 mm | 5        | BE-8705S |
| 6 mm     | 150 mm | 5        | BE-8706S |
| 8 mm     | 200 mm | 5        | BE-8708S |

ERGO™ VDE Insulated Plus-Minus/Phillips-Tip Screwdrivers with 3-Component Handle 5.0/PH1-6.0/PH2



### BE-8510S - BE-8520S

| Tip Size | Length | Quantity | Part No. |
|----------|--------|----------|----------|
| 5.0/PH1  | 80 mm  | 5        | BE-8510S |
| 6.0/PH2  | 100 mm | 5        | BE-8520S |

ERGO™ VDE Insulated Plus-Minus/Pozidriv-Tip Screwdrivers with 3-Component Handle 5.0/PZ1-6.0/PZ2



### BE-8710S - BE-8720S

| Tip Size | Length | Quantity | Part No. |
|----------|--------|----------|----------|
| 5.0/PZ1  | 80 mm  | 5        | BE-8710S |
| 6.0/PZ2  | 100 mm | 5        | BE-8720S |

ERGO™ VDE Insulated Nut Drivers with 3-Component Handle 5.5 mm-10 mm



### BE-7855S - BE-7810S

| Tip Size | Length | Quantity | Part No. |
|----------|--------|----------|----------|
| 5.5 mm   | 125 mm | 5        | BE-7855S |
| 6 mm     | 125 mm | 5        | BE-7806S |
| 7 mm     | 125 mm | 5        | BE-7807S |
| 8 mm     | 125 mm | 5        | BE-7808S |
| 9 mm     | 125 mm | 5        | BE-7809S |
| 10 mm    | 125 mm | 5        | BE-7810S |

ERGO™ VDE Insulated Plus-Minus/  
Pozidriv-Tip Screwdriver Set with  
3-Component Handle - 2 Pcs



ergo



**BE-9890S**

2 175 g 1 BE-9890S

BE-8710S, BE-8720S

ERGO™ VDE Insulated Slotted and  
Phillips Screwdriver Set with 3-Component  
Handle - 5 Pcs



ergo



**BE-9881S**

5 1 BE-9881S

BE-8220S, BE-8040S, BE-8050S

BE-8611S, BE-8621S

ERGO™ VDE Insulated Slotted  
and Pozidriv Screwdriver Set with  
3-Component Handle - 5 Pcs



ergo



**BE-9882S**

5 1 BE-9882S

BE-8220S, BE-8050S, BE-8040S

BE-8811S, BE-8821S

ERGO™ VDE Insulated Plus-Minus/  
Phillips, Plus-Minus/Pozidriv-Tip  
Screwdriver Set with 3-Component Handle  
and 150 V-250 V voltage tester - 5 Pcs



ergo



**BE-9885S**

5 1 BE-9885S

806-1-1

BE-8520S, BE-8510S

BE-8710S, BE-8720S

ERGO™ VDE Insulated Slotted, Pozidriv  
and Plus-Minus/Pozidriv-Tip Screwdriver  
Set with 3-Component Handle - 6 Pcs



ergo



**BE-9884S**

6 1 BE-9884S

BE-8220S, BE-8040S

BE-8710S, BE-8720S

BE-8810S, BE-8820S

ERGO™ VDE Insulated Slotted and  
Phillips Screwdriver Set with 3-Component  
Handle - 7 Pcs



ergo



**BE-9887S**

7 1 BE-9887S

806-1-1

BE-8010S, BE-8050S, BE-8230S,  
BE-8040S

BE-8611S, BE-8621S

ERGO™ VDE Insulated Slotted  
and Pozidriv Screwdriver Set with  
3-Component Handle - 7 Pcs



ergo



**BE-9889S**

7 1 BE-9889S

BE-8010S, BE-8040S, BE-8050S,  
BE-8230S

BE-8821S, BE-8811S

806-1-1



ERGO™ Slotted, Phillips, Pozidriv, TORX® and Plus-Minus/Pozidriv Screwdriver Set with Rubber Grip - 14 Pcs



ergo



**BE-9876S**



14



1 BE-9876S

BE-8010S, BE-8220S, BE-8230S, BE-8040S, BE-8050S



BE-8611S, BE-8621S



BE-8811S, BE-8821S



BE-8910S, BE-8915S, BE-8920S



BE-8710S, BE-8720S



ERGO™ Slim VDE Insulated Slotted Screwdrivers with 3-Component Handle 3.0 mm-6.5 mm



ergo



**BE-8220SL - BE-8255SL**



3.0 mm 100 mm 10 BE-8220SL

3.5 mm 100 mm 10 BE-8230SL

4.0 mm 100 mm 10 BE-8040SL

5.5 mm 125 mm 10 BE-8050SL

6.5 mm 150 mm 10 BE-8255SL

ERGO™ Slim VDE Insulated Phillips Screwdrivers with 3-Component Handle PH1-PH2



ergo



**BE-8610SL - BE-8620SL**



PH 1 80 mm 10 BE-8610SL

PH 2 100 mm 10 BE-8620SL

ERGO™ Slim VDE Insulated Pozidriv Screwdrivers with 3-Component Handle PZ1-PZ2



ergo



**BE-8810SL - BE-8820SL**

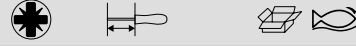

PZ 1 80 mm 10 BE-8810SL

PZ 2 100 mm 10 BE-8820SL

ERGO™ Slim VDE Insulated TORX® Screwdrivers with 3-Component Handle T10-T30



ergo



**BE-8910SL - BE-8930SL**



T 10 100 mm 5 BE-8910SL

T 15 100 mm 5 BE-8915SL

T 20 100 mm 5 BE-8920SL

T 25 125 mm 5 BE-8925SL

T 30 150 mm 5 BE-8930SL

ERGO™ Slim VDE Insulated Plus-Minus/Phillips-Tip Screwdrivers with 3-Component Handle for 5.0/PH1 - 6.0/PH2



ergo



**BE-8510SL - BE-8520SL**



5.0/PH1 80 mm 10 BE-8510SL

6.0/PH2 100 mm 10 BE-8520SL

ERGO™ Slim VDE Insulated Plus-Minus/Pozidriv-Tip Screwdrivers with 3-Component Handle 5.0/PZ1 - 6.0/PZ2



ergo



**BE-8710SL - BE-8720SL**



5.0/PZ1 80 mm 10 BE-8710SL

6.0/PZ2 100 mm 10 BE-8720SL

ERGO™ Slim VDE Insulated Plus-Minus/Pozidriv Screwdriver Set with 3-Component Handle - 2 Pcs



ergo

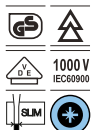

**BE-9890SL**



2 175 g 1 BE-9890SL

BE-8710SL, BE-8720SL

ERGO™ Slim VDE Insulated Phillips Screwdriver Set with 3-Component Handle - 2 Pcs



ergo



**BE-9891SL**



2 132 g 1 BE-9891SL

BE-8610SL, BE-8620SL



ERGO™ Slim VDE Insulated Pozidriv Screwdriver Set with 3-Component Handle - 2 Pcs



ergo

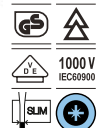

**BE-9894SL**

|   |       |   |           |
|---|-------|---|-----------|
|   |       |   |           |
| 2 | 132 g | 1 | BE-9894SL |

|                      |  |
|----------------------|--|
| BE-8810SL, BE-8820SL |  |
|----------------------|--|

ERGO™ Slim VDE Insulated TORX® Screwdriver Set with 3-Component Handle - 4 Pcs



ergo



**BE-9880SL**

|   |   |           |
|---|---|-----------|
|   |   |           |
| 4 | 1 | BE-9880SL |

|  |  |
|--|--|
| BE-8910SL, BE-8915SL, BE-8920SL, BE-8925SL |  |
|--|--|

ERGO™ Slim VDE Insulated Slotted and Phillips Screwdriver Set with 3-Component Handle - 5 Pcs



ergo



**BE-9881SL**

|   |   |           |
|---|---|-----------|
|   |   |           |
| 5 | 1 | BE-9881SL |

|                                 |  |
|---------------------------------|--|
| BE-8220SL, BE-8040SL, BE-8050SL |  |
| BE-8610SL, BE-8620SL            |  |

ERGO™ Slim VDE Insulated Slotted and Pozidriv Screwdriver Set with 3-Component Handle - 5 Pcs



ergo

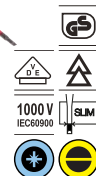

**BE-9882SL**

|   |   |           |
|---|---|-----------|
|   |   |           |
| 5 | 1 | BE-9882SL |

|                                 |  |
|---------------------------------|--|
| BE-8220SL, BE-8040SL, BE-8050SL |  |
| BE-8810SL, BE-8820SL            |  |

ERGO™ Slim VDE Insulated Slotted, Phillips and Torx® Screwdriver Set with 3-Component Handle - 5 pcs



ergo

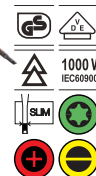

**BE-9871SL**

|   |   |           |
|---|---|-----------|
|   |   |           |
| 5 | 1 | BE-9871SL |

|                      |  |
|----------------------|--|
| BE-8220SL, BE-8040SL |  |
| BE-8910SL            |  |
| BE-8610SL, BE-8620SL |  |

ERGO™ Slim VDE Insulated Slotted, Pozidriv and Torx® Screwdriver Set with 3-Component Handle - 5 pcs



ergo



**BE-9872SL**

|   |   |           |
|---|---|-----------|
|   |   |           |
| 5 | 1 | BE-9872SL |

|                      |  |
|----------------------|--|
| BE-8220SL, BE-8040SL |  |
| BE-8910SL            |  |
| BE-8810SL, BE-8820SL |  |

ERGO™ Slim VDE Insulated Slotted, Phillips, Pozidriv, Torx and Plus-Minus/Phillips Screwdriver Set with 3-Component Handle - 12 Pcs



ergo



**BE-9878SL**

|    |   |           |
|----|---|-----------|
|    |   |           |
| 12 | 1 | BE-9878SL |

|  |  |
|--|--|
| BE-8010S                                   |  |
| BE-8220SL, BE-8230SL, BE-8040SL, BE-8050SL |  |
| BE-8610SL, BE-8620SL                       |  |
| BE-8810SL, BE-8820SL                       |  |
| BE-8510SL, BE-8520SL                       |  |
| BE-8910SL                                  |  |

BahcoFit VDE Insulated Slotted Screwdrivers with Multi-Component Handle 2.5 mm-12 mm



**B196**

|        |        |    |               |
|--------|--------|----|---------------|
|        |        |    |               |
| 2.5 mm | 75 mm  | 10 | B196.025.075  |
| 3 mm   | 100 mm | 10 | B196.030.100  |
| 3.5 mm | 100 mm | 10 | B196.035.100  |
| 4 mm   | 100 mm | 10 | B196.040.100  |
| 5.5 mm | 125 mm | 10 | B196.055.125  |
| 6.5 mm | 150 mm | 10 | B196.065.150  |
| 8 mm   | 175 mm | 10 | B196.080.175  |
| 10 mm  | 200 mm | 10 | B196.100.200  |
| 12 mm  | 200 mm | 10 | B196.120.200  |
| 2.5 mm | 75 mm  | 1  | SB196.025.075 |
| 3 mm   | 100 mm | 1  | SB196.030.100 |
| 3.5 mm | 100 mm | 1  | SB196.035.100 |
| 4 mm   | 100 mm | 1  | SB196.040.100 |
| 5.5 mm | 125 mm | 1  | SB196.055.125 |
| 6.5 mm | 150 mm | 1  | SB196.065.150 |
| 8 mm   | 175 mm | 1  | SB196.080.175 |
| 10 mm  | 200 mm | 1  | SB196.100.200 |
| 12 mm  | 200 mm | 1  | SB196.120.200 |



BahcoFit VDE Insulated Phillips Screwdrivers with Multi-Component Handle PH0-PH4



**B197PH**

| Tip | Length | Qty | Part No.      |
|-----|--------|-----|---------------|
| PH0 | 75 mm  | 10  | B197.000.075  |
| PH1 | 80 mm  | 10  | B197.001.080  |
| PH1 | 150 mm | 10  | B197.001.150  |
| PH2 | 100 mm | 10  | B197.002.100  |
| PH2 | 175 mm | 10  | B197.002.175  |
| PH3 | 150 mm | 10  | B197.003.150  |
| PH4 | 200 mm | 10  | B197.004.200  |
| PH0 | 75 mm  | 1   | SB197.000.075 |
| PH1 | 80 mm  | 1   | SB197.001.080 |
| PH2 | 100 mm | 1   | SB197.002.100 |
| PH3 | 150 mm | 1   | SB197.003.150 |
| PH4 | 200 mm | 1   | SB197.004.200 |

BahcoFit VDE Insulated Pozidriv Screwdrivers with Multi-Component Handle PZ0-PZ3



**B142PZ**

| Tip | Length | Qty | Part No.      |
|-----|--------|-----|---------------|
| PZ0 | 75 mm  | 10  | B142.000.075  |
| PZ1 | 80 mm  | 10  | B142.001.080  |
| PZ1 | 150 mm | 10  | B142.001.150  |
| PZ2 | 100 mm | 10  | B142.002.100  |
| PZ2 | 175 mm | 10  | B142.002.175  |
| PZ3 | 150 mm | 10  | B142.003.150  |
| PZ0 | 75 mm  | 1   | SB142.000.075 |
| PZ1 | 80 mm  | 1   | SB142.001.080 |
| PZ2 | 100 mm | 1   | SB142.002.100 |
| PZ3 | 150 mm | 1   | SB142.003.150 |

BahcoFit VDE Insulated TORX® Screwdrivers with Multi-Component Handle T10-T25



**B150TORX**

| Tip | Length | Qty | Part No.     |
|-----|--------|-----|--------------|
| T10 | 100 mm | 10  | B150.010.100 |
| T15 | 125 mm | 10  | B150.015.125 |
| T20 | 125 mm | 10  | B150.020.125 |

| Tip | Length | Qty | Part No.      |
|-----|--------|-----|---------------|
| T25 | 150 mm | 10  | B150.025.150  |
| T10 | 100 mm | 1   | SB150.010.100 |
| T15 | 125 mm | 1   | SB150.015.125 |
| T20 | 125 mm | 1   | SB150.020.125 |
| T25 | 150 mm | 1   | SB150.025.150 |

BahcoFit VDE Insulated Plus-Minus/Phillips-Tip Screwdrivers with Multi-Component Handle 5.0/PH1 - 6.0/PH2



**B148**

| Tip       | Length | Qty | Part No.      |
|-----------|--------|-----|---------------|
| 5.0mm/PH1 | 80 mm  | 10  | B148.001.080  |
| 6.0mm/PH2 | 100 mm | 10  | B148.002.100  |
| 5.0mm/PH1 | 80 mm  | 1   | SB148.001.080 |
| 6.0mm/PH2 | 100 mm | 1   | SB148.002.100 |

BahcoFit VDE Insulated Nut Drivers with Multi-Component Handle 5.5 mm-13 mm



**B199**

| Tip    | Length | Qty | Part No.      |
|--------|--------|-----|---------------|
| 5.5 mm | 125 mm | 5   | B199.055.125  |
| 6 mm   | 125 mm | 5   | B199.060.125  |
| 7 mm   | 125 mm | 5   | B199.070.125  |
| 8 mm   | 125 mm | 5   | B199.080.125  |
| 9 mm   | 125 mm | 5   | B199.090.125  |
| 10 mm  | 125 mm | 5   | B199.100.125  |
| 11 mm  | 125 mm | 5   | B199.110.125  |
| 12 mm  | 125 mm | 5   | B199.120.125  |
| 13 mm  | 125 mm | 5   | B199.130.125  |
| 5.5 mm | 125 mm | 1   | SB199.055.125 |
| 6 mm   | 125 mm | 1   | SB199.060.125 |
| 7 mm   | 125 mm | 1   | SB199.070.125 |
| 8 mm   | 125 mm | 1   | SB199.080.125 |
| 9 mm   | 125 mm | 1   | SB199.090.125 |
| 10 mm  | 125 mm | 1   | SB199.100.125 |
| 11 mm  | 125 mm | 1   | SB199.110.125 |
| 12 mm  | 125 mm | 1   | SB199.120.125 |
| 13 mm  | 125 mm | 1   | SB199.130.125 |

BahcoFit VDE Insulated Plus-Minus/Pozidriv-Tip Screwdrivers with Multi-Component Handle 5.0/PZ1-6.0/PZ2



**B149**

| Tip       | Length | Qty | Part No.      |
|-----------|--------|-----|---------------|
| 5.0mm/PZ1 | 80 mm  | 10  | B149.001.080  |
| 6.0mm/PZ2 | 100 mm | 10  | B149.002.100  |
| 5.0mm/PZ1 | 80 mm  | 1   | SB149.001.080 |
| 6.0mm/PZ2 | 100 mm | 1   | SB149.002.100 |

BahcoFit VDE Insulated Slotted and Phillips Screwdriver Set with Multi-Component Handle - 2 Pcs



**B220.002**

| Tip | Length | Qty | Part No. |
|-----|--------|-----|----------|
| X   | g      | 1   | B220.002 |

**B196.030.100**

**B197.001.080**

BahcoFit VDE Insulated Plus-Minus/Pozidriv-Tip Screwdriver Set with Multi-Component Handle - 2 Pcs



**B220.012**

| Tip | Length | Qty | Part No. |
|-----|--------|-----|----------|
| X   | g      | 1   | B220.012 |

**B149.001.080, B149.002.100**

BahcoFit VDE Insulated Slotted and Phillips Screwdriver Set with Multi-Component Handle - 5 Pcs



**B220.005**



5 1 B220.005

B196.030.100, B196.040.100,  
B196.055.125



B197.001.080, B197.002.100



BahcoFit VDE Insulated Slotted and Pozidriv Screwdriver Set with Multi-Component Handle - 5 Pcs



**B220.015**



5 1 B220.015

B196.035.100, B196.040.100,  
B196.065.150



B142.001.080, B142.002.100



BahcoFit VDE Insulated Slotted and Phillips Screwdriver Set with Multi-Component Handle - 7 Pcs



**B220.007**



7 1 B220.007

B196.030.100, B196.040.100,  
B196.055.125, B196.065.150



B197.000.075, B197.001.080,  
B197.002.100



BahcoFit VDE Insulated Slotted and Pozidriv Screwdriver Set with Multi-Component Handle - 7 Pcs



**B220.017**



7 1 B220.017

B196.025.075, B196.040.100,  
B196.055.125, B196.065.150



B142.000.075, B142.001.080,  
B142.002.100



BahcoFit VDE Insulated Slotted and Phillips Screwdriver Set with Multi-Component Handle and 150 V-250 V Voltage Tester - 7 Pcs



**B220.027**



7 1 B220.027

B196.030.100, B196.040.100,  
B196.055.125



B197.000.075, B197.001.080,  
B197.002.100



806-1-1



VDE Insulated Slotted Screwdrivers with Multi-Component Handle 3.0 mm-6.5 mm



**623**



|        |        |    |             |
|--------|--------|----|-------------|
| 3.0 mm | 100 mm | 10 | 623-3-100   |
| 3.5 mm | 100 mm | 10 | 623-3.5-100 |
| 4.0 mm | 100 mm | 10 | 623-4-100   |
| 5.5 mm | 125 mm | 10 | 623-5.5-125 |
| 6.5 mm | 150 mm | 10 | 623-6.5-150 |

VDE Insulated Phillips Screwdrivers with Multi-Component Handle PH0-PH2



**625PH**



|      |        |    |           |
|------|--------|----|-----------|
| PH 0 | 100 mm | 10 | 625-0-100 |
| PH 1 | 150 mm | 10 | 625-1-150 |
| PH 2 | 175 mm | 10 | 625-2-175 |

VDE Insulated Slotted and Phillips Screwdriver Set with Multi-Component Handle - 6 Pcs



**620-6**



6 1 620-6

623-4-100, 623-3-100, 623-5.5-125,  
623-6.5-150



625-1-150, 625-2-175



Insulated Ratcheting Screwdriver with Slotted and Phillips Interchangeable Blades Set - 6 Pcs

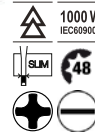

**808061**

|   |                  |   |        |
|---|------------------|---|--------|
|   |                  |   |        |
| 7 | 85 x 85 x 218 mm | 5 | 808061 |

Pouch contains 6 individual blades

|   |  |  |
|---|--|--|
| <b>808060</b>                                     |  |  |
| <b>8610SL-2P, 8620SL-2P</b>                       |  |  |
| <b>8010SL-2P, 8050SL-2P, 8220SL-2P, 8040SL-2P</b> |  |  |

Insulated Ratcheting Screwdriver with Slotted and Pozidriv Interchangeable Blades Set - 6 Pcs



**808062**

|   |                  |   |        |
|---|------------------|---|--------|
|   |                  |   |        |
| 7 | 85 x 85 x 215 mm | 5 | 808062 |

Pouch contains 6 individual blades

|   |  |  |
|---|--|--|
| <b>808060</b>                                     |  |  |
| <b>8820SL-2P, 8810SL-2P</b>                       |  |  |
| <b>8010SL-2P, 8050SL-2P, 8220SL-2P, 8040SL-2P</b> |  |  |

Insulated Ratcheting Screwdriver with Dual-Component Handle



**808060**

|       |        |   |        |
|-------|--------|---|--------|
|       |        |   |        |
| 36 mm | 122 mm | 1 | 808060 |

Insulated Slotted Interchangeable Blades with Reduced Diameter



**8010SL-2P - 8050SL-2P**

|        |        |   |           |
|--------|--------|---|-----------|
|        |        |   |           |
| 0.4 mm | 2.5 mm | 1 | 8010SL-2P |
| 0.5 mm | 3.0 mm | 1 | 8220SL-2P |
| 0.8 mm | 4.0 mm | 1 | 8040SL-2P |
| 1.0 mm | 5.5 mm | 1 | 8050SL-2P |

Insulated Phillips and Pozidriv Interchangeable Blades with Reduced Diameter PH1, PZ1



**8610SL-2P - 8620SL-2P**

|   |   |           |  |
|---|---|-----------|--|
|   |   |           |  |
| 1 | 1 | 8610SL-2P |  |
| 2 | 1 | 8620SL-2P |  |

Insulated Phillips and Pozidriv Interchangeable Blades with Reduced Diameter PH2, PZ2



**8810SL-2P - 8820SL-2P**

|   |   |           |  |
|---|---|-----------|--|
|   |   |           |  |
| 1 | 1 | 8810SL-2P |  |
| 2 | 1 | 8820SL-2P |  |

Insulated Plus-Minus/Phillips-Tip Interchangeable Blades with Reduced Diameter



**8510SL-2P - 8520SL-2P**

|         |   |           |  |
|---------|---|-----------|--|
|         |   |           |  |
| 5.0/PH1 | 1 | 8510SL-2P |  |
| 6.0/PH2 | 1 | 8520SL-2P |  |

Insulated Combi-Tip Slotted and Pozidriv Interchangeable Blades with Reduced Diameter



**8710SL-2P - 8720SL-2P**

|         |   |           |  |
|---------|---|-----------|--|
|         |   |           |  |
| 5.0/PZ1 | 1 | 8710SL-2P |  |
| 6.0/PZ2 | 1 | 8720SL-2P |  |

Insulated TORX® Interchangeable Blades with Reduced Diameter



**8910SL-2P - 8930SL-2P**

|    |   |           |  |
|----|---|-----------|--|
|    |   |           |  |
| 10 | 1 | 8910SL-2P |  |
| 15 | 1 | 8915SL-2P |  |
| 20 | 1 | 8920SL-2P |  |
| 25 | 1 | 8925SL-2P |  |
| 30 | 1 | 8930SL-2P |  |

**PLIERS**

ERGO™ Side Cutting Pliers with Insulated Handles and Phosphate Finish



**2101S**

|        |        |   |           |
|--------|--------|---|-----------|
|        |        |   |           |
| 3.7 mm | 2.0 mm | 3 | 2101S-140 |
| 3.8 mm | 2.5 mm | 3 | 2101S-160 |
| 4.0 mm | 2.7 mm | 3 | 2101S-180 |



ERGO™ Side Cutting Pliers with Insulated Handles and Phosphate Finish 200 mm



**2101S-200**



|        |        |   |           |
|--------|--------|---|-----------|
|        |        |   |           |
| 4.5 mm | 3.0 mm | 3 | 2101S-200 |

VDE Insulated Cable Cutters



**2250V**



|        |         |   |           |
|--------|---------|---|-----------|
|        |         |   |           |
| 170 mm | 0-10 mm | 2 | 2250V-170 |
| 230 mm | 0-15 mm | 2 | 2250V-230 |

ERGO™ Combination Pliers with Insulated Dual-Component Handles and Phosphate Finish



**2628S**



|        |        |   |            |
|--------|--------|---|------------|
|        |        |   |            |
| 2.0 mm | 1.8 mm | 3 | 2628 S-160 |
| 2.5 mm | 2.0 mm | 3 | 2628 S-180 |
| 3.0 mm | 2.5 mm | 3 | 2628 S-200 |

VDE Insulated Side Cutting Pliers



**2171V**



|        |        |   |           |
|--------|--------|---|-----------|
|        |        |   |           |
| 2.7 mm | 160 mm | 2 | 2171V-160 |
| 2.8 mm | 180 mm | 2 | 2171V-180 |
| 4.0 mm | 200 mm | 2 | 2171V-200 |

Insulated Bolt Cutters



**2820VBC**



|        |  |   |         |
|--------|--|---|---------|
|        |  |   |         |
| 630 mm |  | 1 | 2820VBC |

Reinforced Combination Pliers with Insulated Dual-Component Handles and Chrome Finish



**2630SC**



|        |  |   |            |
|--------|--|---|------------|
|        |  |   |            |
| 180 mm |  | 3 | 2630SC-180 |

VDE Insulated End Cutting Pliers



**527V**



|        |        |   |          |
|--------|--------|---|----------|
|        |        |   |          |
| 2 mm   | 160 mm | 2 | 527V-160 |
| 2.5 mm | 200 mm | 2 | 527V-200 |

Side Cutting Pliers with Insulated Cellulose Acetate Handles and Nickel-Chrome Finish



**2674 NVDE**



|        |        |   |           |
|--------|--------|---|-----------|
|        |        |   |           |
| 3.7 mm | 2.0 mm | 1 | 2674 NVDE |

VDE Insulated Combination Pliers



**2678V**



|        |        |   |           |
|--------|--------|---|-----------|
|        |        |   |           |
| 2.7 mm | 160 mm | 2 | 2678V-160 |
| 3.0 mm | 180 mm | 2 | 2678V-180 |
| 4.0 mm | 200 mm | 2 | 2678V-200 |





ERGO™ Snipe Nose Pliers with Insulated Dual-Component Handles and Phosphate Finish



**2430S**



|        |        |   |            |
|--------|--------|---|------------|
|        |        |   |            |
| 2.5 mm | 1.8 mm | 3 | 2430S-140  |
| 3.0 mm | 1.8 mm | 3 | 2430 S-160 |
| 3.0 mm | 1.8 mm | 3 | 2430 S-200 |

ERGO™ Round Nose Pliers with Insulated Dual-Component Handles and Phosphate Finish



**2521S**



|        |   |           |
|--------|---|-----------|
|        |   |           |
| 140 mm | 3 | 2521S-140 |
| 160 mm | 3 | 2521S-160 |

VDE Insulated Long Flat Nose Pliers



**2421V**



|        |   |           |
|--------|---|-----------|
|        |   |           |
| 160 mm | 2 | 2421V-160 |

ERGO™ 45° Bent Tip Snipe Nose Pliers with Insulated Dual-Component Handles and Phosphate Finish



**2427S**



|        |        |   |            |
|--------|--------|---|------------|
|        |        |   |            |
| 3.0 mm | 1.8 mm | 3 | 2427S-160  |
| 3.0 mm | 1.8 mm | 3 | 2427 S-200 |

VDE Insulated Snipe Nose Pliers



**2430V**



|        |        |   |           |
|--------|--------|---|-----------|
|        |        |   |           |
| 3.0 mm | 160 mm | 2 | 2430V-160 |
| 3.0 mm | 200 mm | 2 | 2430V-200 |

VDE Insulated Round Nose Pliers



**2521V**



|        |   |           |
|--------|---|-----------|
|        |   |           |
| 160 mm | 2 | 2521V-160 |

ERGO™ Long Flat Nose Pliers with Insulated Dual-Component Handles and Phosphate Finish



**2421S**



|        |   |           |
|--------|---|-----------|
|        |   |           |
| 140 mm | 3 | 2421S-140 |
| 160 mm | 3 | 2421S-160 |
| 180 mm | 3 | 2421S-180 |

VDE Insulated 45° Tip Angled Snipe Nose Pliers



**2427V**



|        |        |   |           |
|--------|--------|---|-----------|
|        |        |   |           |
| 3.0 mm | 200 mm | 2 | 2427V-200 |

ERGO™ Wire Stripping Pliers with Insulated Dual-Component Handles and Phosphate Finish



**2223S**



|        |   |            |
|--------|---|------------|
|        |   |            |
| 165 mm | 3 | 2223 S-150 |

## VDE Insulated Wire Stripping Pliers



### 2223V

|        |          |   |           |
|--------|----------|---|-----------|
|        |          |   |           |
| 160 mm | 0.5-5 mm | 2 | 2223V-160 |



## Insulated Quick-Adjust Water Pump Pliers with Dual-Component Handle



### 7224S

|    |        |         |
|----|--------|---------|
|    |        |         |
| 16 | 250 mm | 4 7224S |



ISO 8976, IEC 60900

## WRENCHES

### Insulated Thumb Screw Adjustable Wrenches



### 8070V - 8074V

|           |   |       |
|-----------|---|-------|
|           |   |       |
| 165mm/6"  | 2 | 8070V |
| 205mm/8"  | 2 | 8071V |
| 260mm/10" | 2 | 8072V |
| 310mm/12" | 2 | 8073V |
| 390mm/15" | 2 | 8074V |



## Insulated Side Screw Adjustable Wrenches



### 8070VL-8073VL

|           |   |        |
|-----------|---|--------|
|           |   |        |
| 160mm/6"  | 1 | 8070VL |
| 210mm/8"  | 1 | 8071VL |
| 260mm/10" | 1 | 8072VL |
| 310mm/12" | 1 | 8073VL |



## Side Screw Insulated Adjustable Wrenches



### 8071VLT - 8073VLT

|           |   |         |
|-----------|---|---------|
|           |   |         |
| 205mm/8"  | 1 | 8071VLT |
| 255mm/10" | 1 | 8072VLT |
| 305mm/12" | 1 | 8073VLT |



## Insulated Open End Wrenches



### 6MV

|       |   |        |
|-------|---|--------|
|       |   |        |
| 6 mm  | 5 | 6MV-6  |
| 7 mm  | 5 | 6MV-7  |
| 8 mm  | 5 | 6MV-8  |
| 9 mm  | 5 | 6MV-9  |
| 10 mm | 5 | 6MV-10 |
| 11 mm | 5 | 6MV-11 |
| 12 mm | 5 | 6MV-12 |
| 13 mm | 5 | 6MV-13 |
| 14 mm | 5 | 6MV-14 |
| 15 mm | 5 | 6MV-15 |
| 16 mm | 5 | 6MV-16 |
| 17 mm | 3 | 6MV-17 |
| 18 mm | 3 | 6MV-18 |
| 19 mm | 3 | 6MV-19 |
| 20 mm | 3 | 6MV-20 |
| 21 mm | 3 | 6MV-21 |
| 22 mm | 3 | 6MV-22 |
| 23 mm | 3 | 6MV-23 |



|       |   |        |
|-------|---|--------|
| 24 mm | 3 | 6MV-24 |
| 27 mm | 2 | 6MV-27 |
| 30 mm | 2 | 6MV-30 |
| 32 mm | 2 | 6MV-32 |

## Insulated Offset Ring Spanners



### 2MV

|         |   |        |
|---------|---|--------|
|         |   |        |
| 6.0 mm  | 5 | 2MV-6  |
| 7.0 mm  | 5 | 2MV-7  |
| 8.0 mm  | 5 | 2MV-8  |
| 9.0 mm  | 5 | 2MV-9  |
| 10.0 mm | 5 | 2MV-10 |
| 11.0 mm | 5 | 2MV-11 |
| 12.0 mm | 5 | 2MV-12 |
| 13.0 mm | 5 | 2MV-13 |
| 14.0 mm | 5 | 2MV-14 |
| 15.0 mm | 5 | 2MV-15 |
| 16.0 mm | 5 | 2MV-16 |
| 17.0 mm | 3 | 2MV-17 |
| 18.0 mm | 3 | 2MV-18 |
| 19.0 mm | 3 | 2MV-19 |
| 21.0 mm | 3 | 2MV-21 |
| 22.0 mm | 3 | 2MV-22 |
| 23.0 mm | 3 | 2MV-23 |
| 24.0 mm | 3 | 2MV-24 |



## Insulated T-Handle Socket Wrenches



### 28MV

|         |   |         |
|---------|---|---------|
|         |   |         |
| 8.0 mm  | 2 | 28MV-8  |
| 9.0 mm  | 2 | 28MV-9  |
| 10.0 mm | 2 | 28MV-10 |
| 11.0 mm | 2 | 28MV-11 |
| 12.0 mm | 2 | 28MV-12 |
| 13.0 mm | 2 | 28MV-13 |
| 14.0 mm | 2 | 28MV-14 |
| 15.0 mm | 2 | 28MV-15 |
| 16.0 mm | 2 | 28MV-16 |
| 17.0 mm | 2 | 28MV-17 |
| 18.0 mm | 2 | 28MV-18 |
| 19.0 mm | 2 | 28MV-19 |
| 20.0 mm | 2 | 28MV-20 |
| 21.0 mm | 2 | 28MV-21 |
| 22.0 mm | 2 | 28MV-22 |



## Insulated Hexagon L-Keys



### 1999MV



| Size  | Quantity | Part Number |
|-------|----------|-------------|
| 3 mm  | 5        | 1999MV-3    |
| 4 mm  | 5        | 1999MV-4    |
| 5 mm  | 5        | 1999MV-5    |
| 6 mm  | 5        | 1999MV-6    |
| 7 mm  | 5        | 1999MV-7    |
| 8 mm  | 5        | 1999MV-8    |
| 9 mm  | 5        | 1999MV-9    |
| 10 mm | 3        | 1999MV-10   |
| 12 mm | 3        | 1999MV-12   |

## INSULATED SOCKETS & RATCHETS

### 1/2" VDE Insulated Sockets 8 mm-32 mm



### 7800DMV



| Size  | Quantity | Part Number |
|-------|----------|-------------|
| 8 mm  | 10       | 7800DMV-8   |
| 10 mm | 10       | 7800DMV-10  |
| 11 mm | 10       | 7800DMV-11  |
| 12 mm | 10       | 7800DMV-12  |
| 13 mm | 10       | 7800DMV-13  |
| 14 mm | 10       | 7800DMV-14  |
| 15 mm | 10       | 7800DMV-15  |
| 16 mm | 10       | 7800DMV-16  |
| 17 mm | 10       | 7800DMV-17  |
| 18 mm | 10       | 7800DMV-18  |
| 19 mm | 10       | 7800DMV-19  |
| 20 mm | 10       | 7800DMV-20  |
| 21 mm | 10       | 7800DMV-21  |
| 22 mm | 10       | 7800DMV-22  |
| 24 mm | 5        | 7800DMV-24  |
| 27 mm | 5        | 7800DMV-27  |
| 30 mm | 5        | 7800DMV-30  |
| 32 mm | 5        | 7800DMV-32  |

## 1/2" VDE Insulated Ratchets 270 mm



### 8150-1/2V



| Length | Quantity | Part Number |
|--------|----------|-------------|
| 270 mm | 1        | 8150-1/2V   |

## 1/2" VDE Insulated T-Handles 200 mm



### 8154-1/2V



| Length | Width  | Quantity | Part Number |
|--------|--------|----------|-------------|
| 200 mm | 190 mm | 1        | 8154-1/2V   |

## 1/2" VDE Insulated Extensions 125 mm-250 mm



### 8160-1/2V - 8162-1/2V



| Length | Quantity | Part Number |
|--------|----------|-------------|
| 125 mm | 1        | 8160-1/2V   |
| 250 mm | 1        | 8162-1/2V   |

## SCISSORS & KNIVES

### Insulated Electrician Scissors with Finger Guard



### SC127V



| Blade Length | Handle Length | Quantity | Part Number |
|--------------|---------------|----------|-------------|
| 50 mm        | 130 mm        | 5        | SC127V      |

### Insulated Electrician Scissors



### SC150NGV



| Blade Length | Handle Length | Quantity | Part Number |
|--------------|---------------|----------|-------------|
| 38 mm        | 150 mm        | 5        | SC150NGV    |

### Insulated Straight Knives



### 2820VP



| Blade Length | Handle Length | Quantity | Part Number |
|--------------|---------------|----------|-------------|
| 50 mm        | 180 mm        | 2        | 2820VP      |

VDE Insulated Bent Knives



**2820VPC**



|       |        |   |         |
|-------|--------|---|---------|
|       |        |   |         |
| 50 mm | 180 mm | 2 | 2820VPC |

Insulated Bent Knives with Guide



**2820VHELP**



|       |        |   |           |
|-------|--------|---|-----------|
|       |        |   |           |
| 38 mm | 180 mm | 1 | 2820VHELP |

Insulated Cable Knives with Plastic Protective Cap



**2820VDE**



|         |        |    |         |
|---------|--------|----|---------|
|         |        |    |         |
| 55.5 mm | 180 mm | 10 | 2820VDE |

**TWEEZERS**

General Purpose Insulated Tweezers 150 mm



**2820VTEE**



|  |        |   |          |
|--|--------|---|----------|
|  |        |   |          |
|  | 145 mm | 1 | 2820VTEE |

**PROTECTIVE EQUIPMENT**

Insulated Fuse Pullers for NH 00-3



**2820VFP**



|       |   |         |
|-------|---|---------|
|       |   |         |
| 458 g | 1 | 2820VFP |

Insulating Mats for 1000VAC



**2820VM**



|         |         |   |        |
|---------|---------|---|--------|
|         |         |   |        |
| 1000 mm | 1000 mm | 1 | 2820VM |

Insulating Gloves 550 VAC-1000 VAC



**2820VG**



|                 |   |                        |
|-----------------|---|------------------------|
|                 |   |                        |
| 500 V<br>1000 V | 1 | 2820VG05<br>1 2820VG10 |

Cotton Gloves to Wear Under Insulated Gloves



**2820VGCOT**

|      |   |           |
|------|---|-----------|
|      |   |           |
| 50 g | 1 | 2820VGCOT |

THIS ITEM IS NOT INSULATED AND HAS TO BE USED WITH INSULATED GLOVES

**TOOLSETS**

ERGO™ All-Round Pliers Tool Set Insulated - 3 pcs



**9897S/3**

|   |                   |   |         |
|---|-------------------|---|---------|
|   |                   |   |         |
| 3 | 50 x 180 x 400 mm | 1 | 9897S/3 |

|                   |  |                 |
|-------------------|--|-----------------|
| <b>2628 S-180</b> |  | 1000 V IEC60900 |
| <b>2101S-160</b>  |  | 1000 V IEC60900 |
| <b>2430 S-200</b> |  | 1000 V IEC60900 |





Insulated Open End Wrench Set - 8 Pcs



6MV/



8 mm

1 6MV/8T

6MV-10, 6MV-11, 6MV-12, 6MV-13,  
6MV-14, 6MV-17, 6MV-18, 6MV-19



Insulated Open End Wrench Set - 10 Pcs



6MV/10T\_1



10 mm

1 6MV/10T

6MV-10, 6MV-11, 6MV-12, 6MV-13,  
6MV-14, 6MV-16, 6MV-17, 6MV-18,  
6MV-19, 6MV-22



1/2" VDE Insulated Socket Set - 11 Pcs



7811DMV



11 270 x 79 x 350 mm

1 7811DMV

**BAHCO**

7800DMV-13, 7800DMV-10, 7800DMV-11,  
7800DMV-22, 7800DMV-17,  
7800DMV-19, 7800DMV-20



8150-1/2V



8154-1/2V



8160-1/2V



BE-8050S



Foldable Case Insulated Electrician's  
Toolset - 10 Pcs



3045/1VDE



10

225 x 70 x 300 mm

1

3045/1VDE

BE-8010S, BE-8040S, BE-8050S, BE-8220S,  
BE-8230S, BE-8255S



BE-8620S



2171V-160



2430V-160



2678V-180



Leather Briefcase Insulated Electrician's  
Toolset - 10 Pcs



3045V-1



10

60 x 240 x 330 mm

1

3045V-1

2171V-160



2678V-180



2223V-160



BE-8220S, BE-8040S, BE-8050S



BE-8610S, BE-8620S

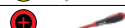

2820VP



SC127V



Insulated Toolset within Leather Bag - 19  
Pcs



3045V-2



19

200 x 285 x 445 mm

1

3045V-2

2171V-160



2678V-180



2430V-160



2223V-160



BE-8220S, BE-8040S, BE-8050S,  
BE-8255S



BE-8610S, BE-8620S



6MV-10, 6MV-11, 6MV-13, 6MV-12,  
6MV-14, 6MV-17, 6MV-19



2820VP



SC150NGV







## Non Sparking Tools



## WRENCHES

Non-Sparking Central Nut Adjustable  
Wrenches Aluminium Bronze



### NS001

| Icon  | L         | Icon | Icon      |
|-------|-----------|------|-----------|
| 18 mm | 150mm/6"  | 5    | NS001-150 |
| 24 mm | 200mm/8"  | 5    | NS001-200 |
| 30 mm | 250mm/10" | 5    | NS001-250 |
| 36 mm | 300mm/12" | 5    | NS001-300 |
| 46 mm | 375mm/15" | 5    | NS001-375 |
| 55 mm | 450mm/18" | 3    | NS001-450 |
| 65 mm | 600mm/24" | 1    | NS001-600 |
| 75 mm | 900mm/36" | 1    | NS001-900 |

Non-Sparking Central Nut Adjustable  
Wrenches Copper Beryllium



### NSB001

| Icon  | L         | Icon | Icon       |
|-------|-----------|------|------------|
| 18 mm | 150mm/6"  | 5    | NSB001-150 |
| 24 mm | 200mm/8"  | 5    | NSB001-200 |
| 30 mm | 250mm/10" | 5    | NSB001-250 |
| 36 mm | 300mm/12" | 5    | NSB001-300 |
| 48 mm | 375mm/15" | 5    | NSB001-375 |
| 55 mm | 450mm/18" | 3    | NSB001-450 |
| 65 mm | 600mm/24" | 3    | NSB001-600 |
| 75 mm | 900mm/36" | 1    | NSB001-900 |

BAM/ZBF/003/21

Non-Sparking Metric Combination  
Wrenches Aluminium Bronze



### NS002

| Icon  | Icon | Icon     |
|-------|------|----------|
| 6 mm  | 5    | NS002-6  |
| 7 mm  | 5    | NS002-7  |
| 8 mm  | 5    | NS002-8  |
| 9 mm  | 5    | NS002-9  |
| 10 mm | 10   | NS002-10 |
| 11 mm | 5    | NS002-11 |
| 12 mm | 5    | NS002-12 |

| Icon  | Icon | Icon     |
|-------|------|----------|
| 13 mm | 10   | NS002-13 |
| 14 mm | 5    | NS002-14 |
| 15 mm | 5    | NS002-15 |
| 16 mm | 5    | NS002-16 |
| 17 mm | 10   | NS002-17 |
| 18 mm | 5    | NS002-18 |
| 19 mm | 10   | NS002-19 |
| 20 mm | 5    | NS002-20 |
| 21 mm | 5    | NS002-21 |
| 22 mm | 10   | NS002-22 |
| 23 mm | 5    | NS002-23 |
| 24 mm | 10   | NS002-24 |
| 25 mm | 5    | NS002-25 |
| 26 mm | 5    | NS002-26 |
| 27 mm | 5    | NS002-27 |
| 28 mm | 5    | NS002-28 |
| 29 mm | 10   | NS002-29 |
| 30 mm | 10   | NS002-30 |
| 31 mm | 5    | NS002-31 |
| 32 mm | 5    | NS002-32 |
| 33 mm | 5    | NS002-33 |
| 34 mm | 5    | NS002-34 |
| 35 mm | 5    | NS002-35 |
| 36 mm | 5    | NS002-36 |
| 38 mm | 5    | NS002-38 |
| 40 mm | 5    | NS002-40 |
| 41 mm | 5    | NS002-41 |
| 42 mm | 5    | NS002-42 |
| 46 mm | 5    | NS002-46 |
| 50 mm | 5    | NS002-50 |
| 52 mm | 5    | NS002-52 |
| 55 mm | 5    | NS002-55 |
| 60 mm | 1    | NS002-60 |
| 65 mm | 1    | NS002-65 |
| 70 mm | 1    | NS002-70 |
| 75 mm | 1    | NS002-75 |
| 80 mm | 1    | NS002-80 |

BAM/ZBF/002/21

Non-Sparking Metric Combination  
Wrenches Copper Beryllium



### NSB002

| Icon  | Icon | Icon      |
|-------|------|-----------|
| 6 mm  | 5    | NSB002-6  |
| 7 mm  | 5    | NSB002-7  |
| 8 mm  | 5    | NSB002-8  |
| 9 mm  | 5    | NSB002-9  |
| 10 mm | 5    | NSB002-10 |
| 11 mm | 5    | NSB002-11 |
| 12 mm | 5    | NSB002-12 |
| 13 mm | 5    | NSB002-13 |
| 17 mm | 5    | NSB002-17 |
| 14 mm | 5    | NSB002-14 |
| 15 mm | 5    | NSB002-15 |
| 16 mm | 5    | NSB002-16 |
| 18 mm | 5    | NSB002-18 |
| 19 mm | 5    | NSB002-19 |
| 20 mm | 5    | NSB002-20 |
| 21 mm | 5    | NSB002-21 |
| 22 mm | 5    | NSB002-22 |
| 25 mm | 5    | NSB002-25 |
| 23 mm | 5    | NSB002-23 |
| 26 mm | 5    | NSB002-26 |

| Icon  | Icon | Icon      |
|-------|------|-----------|
| 24 mm | 5    | NSB002-24 |
| 27 mm | 5    | NSB002-27 |
| 28 mm | 5    | NSB002-28 |
| 29 mm | 5    | NSB002-29 |
| 30 mm | 5    | NSB002-30 |
| 31 mm | 1    | NSB002-31 |
| 32 mm | 10   | NSB002-32 |
| 33 mm | 1    | NSB002-33 |
| 34 mm | 1    | NSB002-34 |
| 35 mm | 1    | NSB002-35 |
| 36 mm | 5    | NSB002-36 |
| 38 mm | 1    | NSB002-38 |
| 40 mm | 1    | NSB002-40 |
| 41 mm | 5    | NSB002-41 |
| 42 mm | 1    | NSB002-42 |
| 46 mm | 1    | NSB002-46 |
| 50 mm | 1    | NSB002-50 |
| 52 mm | 1    | NSB002-52 |
| 55 mm | 1    | NSB002-55 |
| 60 mm | 1    | NSB002-60 |
| 65 mm | 1    | NSB002-65 |
| 70 mm | 1    | NSB002-70 |
| 75 mm | 1    | NSB002-75 |
| 80 mm | 1    | NSB002-80 |

BAM/ZBF/003/21

Non-Sparking Imperial Combination  
Wrenches Aluminium Bronze



### NS003



| Icon     | Icon | Icon     |
|----------|------|----------|
| 1/4 in   | 1    | NS003-8  |
| 11/32 in | 1    | NS003-11 |
| 3/8 in   | 1    | NS003-12 |
| 7/16 in  | 1    | NS003-14 |
| 1/2 in   | 1    | NS003-16 |
| 9/16 in  | 1    | NS003-18 |
| 5/8 in   | 1    | NS003-20 |
| 3/4 in   | 1    | NS003-24 |
| 7/8 in   | 1    | NS003-28 |
| 15/16 in | 1    | NS003-30 |

Non-Sparking Imperial Combination  
Wrenches Copper Beryllium



### NSB003

| Icon     | Icon | Icon      |
|----------|------|-----------|
| 1/4 in   | 1    | NSB003-8  |
| 5/16 in  | 1    | NSB003-10 |
| 11/32 in | 1    | NSB003-11 |
| 3/8 in   | 5    | NSB003-12 |



|  |   |           |
|--|---|-----------|
| 13/32 in   | 1   | NSB003-13 |
| 7/16 in  | 1   | NSB003-14 |
| 1/2 in   | 5   | NSB003-16 |
| 9/16 in  | 1   | NSB003-18 |
| 19/32 in   | 1   | NSB003-19 |
| 5/8 in   | 1   | NSB003-20 |
| 11/16 in   | 5   | NSB003-22 |
| 3/4 in   | 5   | NSB003-24 |
| 25/32 in   | 1   | NSB003-25 |
| 13/16 in   | 1   | NSB003-26 |
| 7/8 in   | 5   | NSB003-28 |
| 15/16 in   | 1   | NSB003-30 |
| 31/32 in   | 1   | NSB003-31 |
| 1 in   | 1   | NSB003-32 |
| 1.1/16 in  | 1   | NSB003-34 |
| 1.1/8 in   | 1   | NSB003-36 |
| 1.3/16 in  | 1   | NSB003-38 |
| 1.1/4 in   | 1   | NSB003-40 |
| 1.5/16 in  | 1   | NSB003-42 |
| 1.3/8 in   | 5   | NSB003-44 |
| 1.7/16 in  | 1   | NSB003-46 |
| 1.1/2 in   | 1   | NSB003-48 |
| 1.9/16 in  | 1   | NSB003-50 |
| 1.5/8 in   | 1   | NSB003-52 |
| 1.11/16 in   | 1   | NSB003-54 |
| 1.3/4 in   | 1   | NSB003-56 |
| 1.13/16 in   | 1   | NSB003-58 |
| 1.7/8 in   | 1   | NSB003-60 |
| 1.15/16 in   | 1   | NSB003-62 |
| 2 in   | 5   | NSB003-64 |
| 2.1/8 in   | 1   | NSB003-68 |
| 2.1/4 in   | 1   | NSB003-72 |
| 2.1/2 in   | 1   | NSB003-80 |
| 2.5/8 in   | 1   | NSB003-84 |
| 2.3/4 in   | 1   | NSB003-88 |



BAM/ZBF/003/21

Non-Sparking Metric Double Open Ended Wrenches Aluminium Bronze



**NS006**

|  |   |            |
|--|---|------------|
| 6x7 mm   | 1   | NS006-0607 |
| 6x8 mm   | 1   | NS006-0608 |
| 7x8 mm   | 1   | NS006-0708 |
| 7x9 mm   | 1   | NS006-0709 |
| 8x9 mm   | 1   | NS006-0809 |
| 8x10 mm  | 1   | NS006-0810 |
| 9x10 mm  | 1   | NS006-0910 |
| 9x11 mm  | 1   | NS006-0911 |
| 10x11 mm   | 1   | NS006-1011 |
| 10x12 mm   | 1   | NS006-1012 |
| 10x13 mm   | 1   | NS006-1013 |
| 10x14 mm   | 1   | NS006-1014 |
| 11x13 mm   | 1   | NS006-1113 |
| 11x14 mm   | 1   | NS006-1114 |
| 12x13 mm   | 1   | NS006-1213 |
| 12x14 mm   | 1   | NS006-1214 |
| 13x15 mm   | 1   | NS006-1315 |
| 14x15 mm   | 1   | NS006-1415 |
| 14x16 mm   | 1   | NS006-1416 |
| 14x17 mm   | 1   | NS006-1417 |
| 16x17 mm   | 1   | NS006-1617 |



|  |   |            |
|---|---|------------|
| 16x18 mm  | 1   | NS006-1618 |
| 17x19 mm  | 1   | NS006-1719 |
| 17x22 mm  | 1   | NS006-1722 |
| 18x19 mm  | 1   | NS006-1819 |
| 18x20 mm  | 1   | NS006-1820 |
| 19x20 mm  | 1   | NS006-1920 |
| 19x22 mm  | 1   | NS006-1922 |
| 19x24 mm  | 1   | NS006-1924 |
| 20x22 mm  | 1   | NS006-2022 |
| 21x22 mm  | 1   | NS006-2122 |
| 21x23 mm  | 1   | NS006-2123 |
| 22x23 mm  | 1   | NS006-2223 |
| 22x24 mm  | 1   | NS006-2224 |
| 22x27 mm  | 1   | NS006-2227 |
| 23x26 mm  | 1   | NS006-2326 |
| 24x25 mm  | 1   | NS006-2425 |
| 24x26 mm  | 1   | NS006-2426 |
| 24x27 mm  | 1   | NS006-2427 |
| 24x30 mm  | 1   | NS006-2430 |
| 25x28 mm  | 1   | NS006-2528 |
| 26x29 mm  | 1   | NS006-2629 |
| 27x29 mm  | 1   | NS006-2729 |
| 27x30 mm  | 1   | NS006-2730 |
| 27x32 mm  | 1   | NS006-2732 |
| 28x30 mm  | 1   | NS006-2830 |
| 30x31 mm  | 1   | NS006-3031 |
| 30x32 mm  | 1   | NS006-3032 |
| 30x34 mm  | 1   | NS006-3034 |
| 30x36 mm  | 1   | NS006-3036 |
| 32x34 mm  | 1   | NS006-3234 |
| 32x35 mm  | 1   | NS006-3235 |
| 32x36 mm  | 1   | NS006-3236 |
| 33x35 mm  | 1   | NS006-3335 |
| 34x36 mm  | 1   | NS006-3436 |
| 35x36 mm  | 1   | NS006-3536 |
| 36x38 mm  | 1   | NS006-3638 |
| 36x41 mm  | 1   | NS006-3641 |
| 38x42 mm  | 1   | NS006-3642 |
| 41x46 mm  | 1   | NS006-4146 |
| 46x50 mm  | 1   | NS006-4650 |
| 50x52 mm  | 1   | NS006-5052 |
| 50x55 mm  | 1   | NS006-5055 |
| 50x60 mm  | 1   | NS006-5060 |
| 50x62 mm  | 1   | NS006-5062 |
| 55x60 mm  | 1   | NS006-5560 |
| 60x65 mm  | 1   | NS006-6065 |
| 65x70 mm  | 1   | NS006-6570 |



BAM/ZBF/002/21

Non-Sparking Metric Double Open Ended Wrenches Copper Beryllium



**NSB006**

|  |   |             |
|---|---|-------------|
| 6X7 mm  | 1   | NSB006-0607 |
| 6X8 mm  | 1   | NSB006-0608 |
| 7X8 mm  | 1   | NSB006-0708 |
| 7X9 mm  | 1   | NSB006-0709 |

|  |   |             |
|---|---|-------------|
| 8X9 mm  | 1   | NSB006-0809 |
| 8X10 mm   | 1   | NSB006-0810 |
| 9X10 mm   | 1   | NSB006-0910 |
| 9X11 mm   | 1   | NSB006-0911 |
| 10X11 mm  | 1   | NSB006-1011 |
| 10X12 mm  | 1   | NSB006-1012 |
| 10X13 mm  | 1   | NSB006-1013 |
| 10X14 mm  | 1   | NSB006-1014 |
| 11X13 mm  | 1   | NSB006-1113 |
| 11X14 mm  | 1   | NSB006-1114 |
| 12X13 mm  | 1   | NSB006-1213 |
| 12X14 mm  | 1   | NSB006-1214 |
| 13X15 mm  | 1   | NSB006-1315 |
| 14X15 mm  | 1   | NSB006-1415 |
| 14X16 mm  | 1   | NSB006-1416 |
| 14X17 mm  | 1   | NSB006-1417 |
| 16X17 mm  | 1   | NSB006-1617 |
| 16X18 mm  | 1   | NSB006-1618 |
| 17X19 mm  | 1   | NSB006-1719 |
| 17X22 mm  | 1   | NSB006-1722 |
| 18X19 mm  | 1   | NSB006-1819 |
| 18X20 mm  | 1   | NSB006-1820 |
| 19X20 mm  | 1   | NSB006-1920 |
| 19X22 mm  | 1   | NSB006-1922 |
| 19X24 mm  | 1   | NSB006-1924 |
| 20X22 mm  | 1   | NSB006-2022 |
| 21X22 mm  | 1   | NSB006-2122 |
| 21X23 mm  | 1   | NSB006-2123 |
| 22X23 mm  | 1   | NSB006-2223 |
| 22X24 mm  | 1   | NSB006-2224 |
| 22X27 mm  | 1   | NSB006-2227 |
| 23X26 mm  | 1   | NSB006-2326 |
| 24X25 mm  | 1   | NSB006-2425 |
| 24X26 mm  | 1   | NSB006-2426 |
| 24X27 mm  | 1   | NSB006-2427 |
| 24X30 mm  | 1   | NSB006-2430 |
| 25x28 mm  | 1   | NSB006-2528 |
| 26x29 mm  | 1   | NSB006-2629 |
| 27x29 mm  | 1   | NSB006-2729 |
| 27x30 mm  | 1   | NSB006-2730 |
| 27x32 mm  | 1   | NSB006-2732 |
| 28x30 mm  | 1   | NSB006-2830 |
| 30x31 mm  | 1   | NSB006-3031 |
| 30x32 mm  | 1   | NSB006-3032 |
| 30x34 mm  | 1   | NSB006-3034 |
| 30x36 mm  | 1   | NSB006-3036 |
| 32x34 mm  | 1   | NSB006-3234 |
| 32x35 mm  | 1   | NSB006-3235 |
| 32x36 mm  | 1   | NSB006-3236 |
| 33x35 mm  | 1   | NSB006-3335 |
| 34x36 mm  | 1   | NSB006-3436 |
| 35x36 mm  | 1   | NSB006-3536 |
| 36x38 mm  | 1   | NSB006-3638 |
| 36x41 mm  | 1   | NSB006-3641 |
| 38x42 mm  | 1   | NSB006-3642 |
| 41x46 mm  | 1   | NSB006-4146 |
| 46x50 mm  | 1   | NSB006-4650 |
| 50x52 mm  | 1   | NSB006-5052 |
| 50x55 mm  | 1   | NSB006-5055 |
| 50x60 mm  | 1   | NSB006-5060 |
| 50x62 mm  | 1   | NSB006-5062 |
| 55X60 mm  | 1   | NSB006-5560 |
| 60X65 mm  | 1   | NSB006-6065 |
| 65X70 mm  | 1   | NSB006-6570 |

BAM/ZBF/003/21



Non-Sparking Metric Double Ended Flat Ring Wrenches Aluminium Bronze



|          |   |             |
|----------|---|-------------|
| 10X11 mm | 1 | NSB010-1011 |
| 10X12 mm | 1 | NSB010-1012 |
| 12X14 mm | 1 | NSB010-1214 |
| 13X15 mm | 1 | NSB010-1315 |
| 14X17 mm | 1 | NSB010-1417 |
| 16X18 mm | 1 | NSB010-1618 |
| 17X19 mm | 1 | NSB010-1719 |
| 17X22 mm | 1 | NSB010-1722 |
| 18X19 mm | 1 | NSB010-1819 |
| 19X21 mm | 1 | NSB010-1921 |
| 19X22 mm | 1 | NSB010-1922 |
| 20X22 mm | 1 | NSB010-2022 |
| 21X23 mm | 1 | NSB010-2123 |
| 22X24 mm | 1 | NSB010-2224 |
| 24X27 mm | 1 | NSB010-2427 |
| 25X28 mm | 1 | NSB010-2528 |
| 26X28 mm | 1 | NSB010-2628 |
| 27X30 mm | 1 | NSB010-2730 |
| 27X32 mm | 1 | NSB010-2732 |
| 30X32 mm | 1 | NSB010-3032 |
| 30X36 mm | 1 | NSB010-3036 |
| 32X36 mm | 1 | NSB010-3236 |
| 36X41 mm | 1 | NSB010-3641 |
| 41X46 mm | 1 | NSB010-4146 |
| 46X50 mm | 1 | NSB010-4650 |

BAM/ZBF/003/21

Non-Sparking Metric Double Ended Offset Ring Wrenches Aluminium Bronze



Non-Sparking Metric Double Ended Offset Ring Wrenches Copper Beryllium



NSB011



|          |   |             |
|----------|---|-------------|
| 6x7 mm   | 1 | NSB011-0607 |
| 8x9 mm   | 1 | NSB011-0809 |
| 10x11 mm | 1 | NSB011-1011 |
| 12x13 mm | 1 | NSB011-1213 |
| 14x15 mm | 1 | NSB011-1415 |
| 16x17 mm | 1 | NSB011-1617 |
| 18x19 mm | 1 | NSB011-1819 |
| 20x22 mm | 1 | NSB011-2022 |
| 21x23 mm | 1 | NSB011-2123 |
| 24x26 mm | 1 | NSB011-2426 |
| 25x28 mm | 1 | NSB011-2528 |
| 27x29 mm | 1 | NSB011-2729 |
| 30x32 mm | 1 | NSB011-3032 |

BAM/ZBF/003/21

Non-Sparking Metric Slogging Open Wrenches Aluminium Bronze



NS100



|       |   |          |
|-------|---|----------|
| 17 mm | 1 | NS100-17 |
| 19 mm | 1 | NS100-19 |
| 22 mm | 1 | NS100-22 |
| 24 mm | 1 | NS100-24 |
| 25 mm | 1 | NS100-25 |
| 27 mm | 1 | NS100-27 |
| 28 mm | 1 | NS100-28 |
| 29 mm | 1 | NS100-29 |
| 30 mm | 1 | NS100-30 |
| 32 mm | 1 | NS100-32 |
| 33 mm | 1 | NS100-33 |
| 34 mm | 1 | NS100-34 |
| 35 mm | 1 | NS100-35 |
| 36 mm | 1 | NS100-36 |
| 37 mm | 1 | NS100-37 |
| 38 mm | 1 | NS100-38 |
| 41 mm | 1 | NS100-41 |
| 42 mm | 1 | NS100-42 |

Non-Sparking Metric Double Ended Flat Ring Wrenches Copper Beryllium



NS011



|          |   |            |
|----------|---|------------|
| 6x7 mm   | 1 | NS011-0607 |
| 8x9 mm   | 1 | NS011-0809 |
| 10x11 mm | 1 | NS011-1011 |
| 12x13 mm | 1 | NS011-1213 |
| 14x15 mm | 1 | NS011-1415 |
| 16x17 mm | 1 | NS011-1617 |
| 18x19 mm | 1 | NS011-1819 |
| 20x22 mm | 1 | NS011-2022 |
| 21x23 mm | 1 | NS011-2123 |
| 24x26 mm | 1 | NS011-2426 |
| 25x28 mm | 1 | NS011-2528 |
| 27x29 mm | 1 | NS011-2729 |
| 30x32 mm | 1 | NS011-3032 |

BAM/ZBF/002/21





NSB010



|         |   |             |
|---------|---|-------------|
| 6X7 mm  | 1 | NSB010-0607 |
| 7X9 mm  | 1 | NSB010-0709 |
| 8X9 mm  | 1 | NSB010-0809 |
| 9X11 mm | 1 | NSB010-0911 |





|  |  |  |
|--|---|---|
| 45 mm  | 1   | NS100-45  |
| 46 mm  | 1   | NS100-46  |
| 47 mm  | 1   | NS100-47  |
| 50 mm  | 1   | NS100-50  |
| 52 mm  | 1   | NS100-52  |
| 54 mm  | 1   | NS100-54  |
| 55 mm  | 1   | NS100-55  |
| 56 mm  | 1   | NS100-56  |
| 58 mm  | 1   | NS100-58  |
| 60 mm  | 1   | NS100-60  |
| 63 mm  | 1   | NS100-63  |
| 65 mm  | 1   | NS100-65  |
| 67 mm  | 1   | NS100-67  |
| 70 mm  | 1   | NS100-70  |
| 71 mm  | 1   | NS100-71  |
| 75 mm  | 1   | NS100-75  |
| 77 mm  | 1   | NS100-77  |
| 80 mm  | 1   | NS100-80  |
| 82 mm  | 1   | NS100-82  |
| 85 mm  | 1   | NS100-85  |
| 88 mm  | 1   | NS100-88  |
| 90 mm  | 1   | NS100-90  |
| 94 mm  | 1   | NS100-94  |
| 95 mm  | 1   | NS100-95  |
| 100 mm   | 1   | NS100-100   |
| 105 mm   | 1   | NS100-105   |
| 110 mm   | 1   | NS100-110   |
| 115 mm   | 1   | NS100-115   |
| 120 mm   | 1   | NS100-120   |



BAM/ZBF/002/21

Non-Sparking Metric Slogging Open Wrenches Copper Beryllium



**NSB100**

|  |  |  |
|--|---|---|
| 17 mm  | 1   | NSB100-17   |
| 19 mm  | 1   | NSB100-19   |
| 22 mm  | 1   | NSB100-22   |
| 24 mm  | 1   | NSB100-24   |
| 25 mm  | 1   | NSB100-25   |
| 27 mm  | 1   | NSB100-27   |
| 28 mm  | 1   | NSB100-28   |
| 29 mm  | 1   | NSB100-29   |
| 30 mm  | 1   | NSB100-30   |
| 32 mm  | 1   | NSB100-32   |
| 33 mm  | 1   | NSB100-33   |
| 34 mm  | 1   | NSB100-34   |
| 35 mm  | 1   | NSB100-35   |
| 36 mm  | 1   | NSB100-36   |
| 37 mm  | 1   | NSB100-37   |



|  |  |  |
|---|---|---|
| 38 mm   | 1   | NSB100-38   |
| 41 mm   | 1   | NSB100-41   |
| 42 mm   | 1   | NSB100-42   |
| 45 mm   | 1   | NSB100-45   |
| 46 mm   | 1   | NSB100-46   |
| 47 mm   | 1   | NSB100-47   |
| 50 mm   | 1   | NSB100-50   |
| 52 mm   | 1   | NSB100-52   |
| 54 mm   | 1   | NSB100-54   |
| 55 mm   | 1   | NSB100-55   |
| 56 mm   | 1   | NSB100-56   |
| 58 mm   | 1   | NSB100-58   |
| 60 mm   | 1   | NSB100-60   |
| 63 mm   | 1   | NSB100-63   |
| 65 mm   | 1   | NSB100-65   |
| 67 mm   | 1   | NSB100-67   |
| 70 mm   | 1   | NSB100-70   |
| 71 mm   | 1   | NSB100-71   |
| 75 mm   | 1   | NSB100-75   |
| 77 mm   | 1   | NSB100-77   |
| 80 mm   | 1   | NSB100-80   |
| 82 mm   | 1   | NSB100-82   |
| 85 mm   | 1   | NSB100-85   |
| 88 mm   | 1   | NSB100-88   |
| 90 mm   | 1   | NSB100-90   |
| 94 mm   | 1   | NSB100-94   |
| 95 mm   | 1   | NSB100-95   |
| 100 mm  | 1   | NSB100-100  |
| 105 mm  | 1   | NSB100-105  |
| 110 mm  | 1   | NSB100-110  |
| 115 mm  | 1   | NSB100-115  |
| 120 mm  | 1   | NSB100-120  |



BAM/ZBF/003/21

Non-Sparking Metric Slogging Ring Wrenches Aluminium Bronze



**NS104**

|  |  |  |
|---|---|---|
| 17 mm   | 1   | NS104-17  |
| 19 mm   | 1   | NS104-19  |
| 20 mm   | 1   | NS104-20  |
| 22 mm   | 1   | NS104-22  |
| 24 mm   | 1   | NS104-24  |
| 25 mm   | 1   | NS104-25  |
| 26 mm   | 1   | NS104-26  |
| 27 mm   | 1   | NS104-27  |
| 28 mm   | 1   | NS104-28  |
| 29 mm   | 1   | NS104-29  |
| 30 mm   | 1   | NS104-30  |
| 31 mm   | 1   | NS104-31  |
| 32 mm   | 1   | NS104-32  |

|  |  |  |
|---|---|---|
| 33 mm   | 1   | NS104-33  |
| 34 mm   | 1   | NS104-34  |
| 35 mm   | 1   | NS104-35  |
| 36 mm   | 1   | NS104-36  |
| 37 mm   | 1   | NS104-37  |
| 38 mm   | 1   | NS104-38  |
| 39 mm   | 1   | NS104-39  |
| 40 mm   | 1   | NS104-40  |
| 41 mm   | 1   | NS104-41  |
| 42 mm   | 1   | NS104-42  |
| 43 mm   | 1   | NS104-43  |
| 44 mm   | 1   | NS104-44  |
| 45 mm   | 1   | NS104-45  |
| 46 mm   | 1   | NS104-46  |
| 47 mm   | 1   | NS104-47  |
| 48 mm   | 1   | NS104-48  |
| 49 mm   | 1   | NS104-49  |
| 50 mm   | 1   | NS104-50  |
| 51 mm   | 1   | NS104-51  |
| 52 mm   | 1   | NS104-52  |
| 53 mm   | 1   | NS104-53  |
| 54 mm   | 1   | NS104-54  |
| 55 mm   | 1   | NS104-55  |
| 56 mm   | 1   | NS104-56  |
| 57 mm   | 1   | NS104-57  |
| 58 mm   | 1   | NS104-58  |
| 59 mm   | 1   | NS104-59  |
| 60 mm   | 1   | NS104-60  |
| 61 mm   | 1   | NS104-61  |
| 62 mm   | 1   | NS104-62  |
| 63 mm   | 1   | NS104-63  |
| 64 mm   | 1   | NS104-64  |
| 65 mm   | 1   | NS104-65  |
| 66 mm   | 1   | NS104-66  |
| 67 mm   | 1   | NS104-67  |
| 68 mm   | 1   | NS104-68  |
| 69 mm   | 1   | NS104-69  |
| 70 mm   | 1   | NS104-70  |
| 71 mm   | 1   | NS104-71  |
| 72 mm   | 1   | NS104-72  |
| 73 mm   | 1   | NS104-73  |
| 74 mm   | 1   | NS104-74  |
| 75 mm   | 1   | NS104-75  |
| 76 mm   | 1   | NS104-76  |
| 77 mm   | 1   | NS104-77  |
| 78 mm   | 1   | NS104-78  |
| 79 mm   | 1   | NS104-79  |
| 80 mm   | 1   | NS104-80  |
| 81 mm   | 1   | NS104-81  |
| 82 mm   | 1   | NS104-82  |
| 83 mm   | 1   | NS104-83  |
| 84 mm   | 1   | NS104-84  |
| 85 mm   | 1   | NS104-85  |
| 86 mm   | 1   | NS104-86  |
| 87 mm   | 1   | NS104-87  |
| 88 mm   | 1   | NS104-88  |
| 89 mm   | 1   | NS104-89  |
| 90 mm   | 1   | NS104-90  |
| 92 mm   | 1   | NS104-92  |
| 94 mm   | 1   | NS104-94  |
| 95 mm   | 1   | NS104-95  |
| 98 mm   | 1   | NS104-98  |
| 100 mm  | 1   | NS104-100   |
| 105 mm  | 1   | NS104-105   |
| 110 mm  | 1   | NS104-110   |
| 115 mm  | 1   | NS104-115   |
| 120 mm  | 1   | NS104-120   |

BAM/ZBF/002/21



Non-Sparking Metric Slogging Ring  
Wrenches Copper Beryllium



**NSB104**



|       |   |           |
|-------|---|-----------|
| 17 mm | 1 | NSB104-17 |
| 19 mm | 1 | NSB104-19 |
| 20 mm | 1 | NSB104-20 |
| 22 mm | 1 | NSB104-22 |
| 24 mm | 1 | NSB104-24 |
| 25 mm | 1 | NSB104-25 |
| 26 mm | 1 | NSB104-26 |
| 27 mm | 1 | NSB104-27 |
| 28 mm | 1 | NSB104-28 |
| 29 mm | 1 | NSB104-29 |
| 30 mm | 1 | NSB104-30 |
| 31 mm | 1 | NSB104-31 |
| 32 mm | 1 | NSB104-32 |
| 33 mm | 1 | NSB104-33 |
| 34 mm | 1 | NSB104-34 |
| 35 mm | 1 | NSB104-35 |
| 36 mm | 1 | NSB104-36 |
| 37 mm | 1 | NSB104-37 |
| 38 mm | 1 | NSB104-38 |
| 39 mm | 1 | NSB104-39 |
| 40 mm | 1 | NSB104-40 |
| 41 mm | 1 | NSB104-41 |
| 42 mm | 1 | NSB104-42 |
| 43 mm | 1 | NSB104-43 |
| 44 mm | 1 | NSB104-44 |
| 45 mm | 1 | NSB104-45 |
| 46 mm | 1 | NSB104-46 |
| 47 mm | 1 | NSB104-47 |
| 48 mm | 1 | NSB104-48 |
| 49 mm | 1 | NSB104-49 |
| 50 mm | 1 | NSB104-50 |
| 51 mm | 1 | NSB104-51 |
| 52 mm | 1 | NSB104-52 |
| 53 mm | 1 | NSB104-53 |
| 54 mm | 1 | NSB104-54 |
| 55 mm | 1 | NSB104-55 |
| 56 mm | 1 | NSB104-56 |
| 57 mm | 1 | NSB104-57 |
| 58 mm | 1 | NSB104-58 |
| 59 mm | 1 | NSB104-59 |
| 60 mm | 1 | NSB104-60 |
| 61 mm | 1 | NSB104-61 |
| 62 mm | 1 | NSB104-62 |
| 63 mm | 1 | NSB104-63 |
| 64 mm | 1 | NSB104-64 |
| 65 mm | 1 | NSB104-65 |
| 66 mm | 1 | NSB104-66 |
| 67 mm | 1 | NSB104-67 |
| 68 mm | 1 | NSB104-68 |
| 69 mm | 1 | NSB104-69 |
| 70 mm | 1 | NSB104-70 |
| 71 mm | 1 | NSB104-71 |
| 72 mm | 1 | NSB104-72 |
| 73 mm | 1 | NSB104-73 |
| 74 mm | 1 | NSB104-74 |
| 75 mm | 1 | NSB104-75 |
| 76 mm | 1 | NSB104-76 |

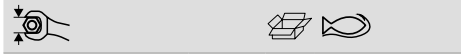

|        |   |            |
|--------|---|------------|
| 77 mm  | 1 | NSB104-77  |
| 78 mm  | 1 | NSB104-78  |
| 79 mm  | 1 | NSB104-79  |
| 80 mm  | 1 | NSB104-80  |
| 81 mm  | 1 | NSB104-81  |
| 82 mm  | 1 | NSB104-82  |
| 83 mm  | 1 | NSB104-83  |
| 84 mm  | 1 | NSB104-84  |
| 85 mm  | 1 | NSB104-85  |
| 86 mm  | 1 | NSB104-86  |
| 87 mm  | 1 | NSB104-87  |
| 88 mm  | 1 | NSB104-88  |
| 89 mm  | 1 | NSB104-89  |
| 90 mm  | 1 | NSB104-90  |
| 92 mm  | 1 | NSB104-92  |
| 94 mm  | 1 | NSB104-94  |
| 95 mm  | 1 | NSB104-95  |
| 98 mm  | 1 | NSB104-98  |
| 100 mm | 1 | NSB104-100 |
| 105 mm | 1 | NSB104-105 |
| 110 mm | 1 | NSB104-110 |
| 115 mm | 1 | NSB104-115 |
| 120 mm | 1 | NSB104-120 |

BAM/ZBF/003/21

Non-Sparking Imperial Slogging Ring  
Wrenches Aluminium Bronze



**NS106**

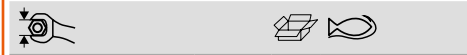

|            |   |          |
|------------|---|----------|
| 5/8 in     | 1 | NS106-20 |
| 11/16 in   | 1 | NS106-22 |
| 3/4 in     | 1 | NS106-24 |
| 25/32 in   | 1 | NS106-25 |
| 13/16 in   | 1 | NS106-26 |
| 7/8 in     | 1 | NS106-28 |
| 15/16 in   | 1 | NS106-30 |
| 1 in       | 1 | NS106-32 |
| 1 1/16 in  | 1 | NS106-34 |
| 1 1/8 in   | 1 | NS106-36 |
| 1 3/16 in  | 1 | NS106-38 |
| 1 1/4 in   | 1 | NS106-40 |
| 1 5/16 in  | 1 | NS106-42 |
| 1 3/8 in   | 1 | NS106-44 |
| 1 13/32 in | 1 | NS106-45 |
| 1 7/16 in  | 1 | NS106-46 |
| 1 1/2 in   | 1 | NS106-48 |
| 1 9/16 in  | 1 | NS106-50 |
| 1 5/8 in   | 1 | NS106-52 |
| 1 11/16 in | 1 | NS106-54 |
| 1 3/4 in   | 1 | NS106-56 |
| 1 13/16 in | 1 | NS106-58 |
| 1 7/8 in   | 1 | NS106-60 |
| 1 15/16 in | 1 | NS106-62 |
| 2 in       | 1 | NS106-64 |
| 2 1/16 in  | 1 | NS106-66 |
| 2 1/8 in   | 1 | NS106-68 |
| 2 3/16 in  | 1 | NS106-70 |
| 2 13/64 in | 1 | NS106-71 |
| 2 1/4 in   | 1 | NS106-72 |

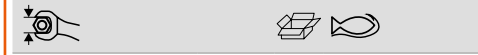

|            |   |           |
|------------|---|-----------|
| 2 5/16 in  | 1 | NS106-74  |
| 2 3/8 in   | 1 | NS106-76  |
| 2 7/16 in  | 1 | NS106-78  |
| 2 1/2 in   | 1 | NS106-80  |
| 2 9/16 in  | 1 | NS106-82  |
| 2 5/8 in   | 1 | NS106-84  |
| 2 3/4 in   | 1 | NS106-88  |
| 2 13/16 in | 1 | NS106-90  |
| 2 7/8 in   | 1 | NS106-92  |
| 2 15/16 in | 1 | NS106-94  |
| 3 in       | 1 | NS106-96  |
| 3 1/16 in  | 1 | NS106-98  |
| 3 1/8 in   | 1 | NS106-100 |
| 3 1/4 in   | 1 | NS106-104 |
| 3 3/8 in   | 1 | NS106-108 |
| 3 1/2 in   | 1 | NS106-112 |
| 3 9/16 in  | 1 | NS106-114 |
| 3 5/8 in   | 1 | NS106-116 |
| 3 3/4 in   | 1 | NS106-120 |
| 3 7/8 in   | 1 | NS106-124 |
| 3 15/16 in | 1 | NS106-126 |
| 4 in       | 1 | NS106-128 |
| 4 1/8 in   | 1 | NS106-132 |
| 4 1/4 in   | 1 | NS106-136 |
| 4 5/16 in  | 1 | NS106-138 |
| 4 1/2 in   | 1 | NS106-144 |
| 4 9/16 in  | 1 | NS106-146 |
| 4 11/16 in | 1 | NS106-150 |
| 4 7/8 in   | 1 | NS106-156 |
| 4 15/16 in | 1 | NS106-158 |

BAM/ZBF/002/21

Non-Sparking Imperial Slogging Ring  
Wrenches Copper Beryllium



**NSB106**

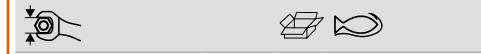

|            |   |           |
|------------|---|-----------|
| 5/8 in     | 1 | NSB106-20 |
| 11/16 in   | 1 | NSB106-22 |
| 3/4 in     | 1 | NSB106-24 |
| 25/32 in   | 1 | NSB106-25 |
| 13/16 in   | 1 | NSB106-26 |
| 7/8 in     | 1 | NSB106-28 |
| 15/16 in   | 1 | NSB106-30 |
| 1 in       | 1 | NSB106-32 |
| 1.1/16 in  | 1 | NSB106-34 |
| 1.1/8 in   | 1 | NSB106-36 |
| 1.3/16 in  | 1 | NSB106-38 |
| 1.1/4 in   | 1 | NSB106-40 |
| 1.5/16 in  | 1 | NSB106-42 |
| 1.3/8 in   | 1 | NSB106-44 |
| 1.13/32 in | 1 | NSB106-45 |
| 1.7/16 in  | 1 | NSB106-46 |
| 1.1/2 in   | 1 | NSB106-48 |
| 1.9/16 in  | 1 | NSB106-50 |
| 1.5/8 in   | 1 | NSB106-52 |
| 1.11/16 in | 1 | NSB106-54 |
| 1.3/4 in   | 1 | NSB106-56 |
| 1.13/16 in | 1 | NSB106-58 |
| 1.7/8 in   | 1 | NSB106-60 |

| 1.15/16 in | 1 | NSB106-62  |
|------------|---|------------|
| 2 in       | 1 | NSB106-64  |
| 2.1/16 in  | 1 | NSB106-66  |
| 2.1/8 in   | 1 | NSB106-68  |
| 2.3/16 in  | 1 | NSB106-70  |
| 2.13/64 in | 1 | NSB106-71  |
| 2.1/4 in   | 1 | NSB106-72  |
| 2.5/16 in  | 1 | NSB106-74  |
| 2.3/8 in   | 1 | NSB106-76  |
| 2.7/16 in  | 1 | NSB106-78  |
| 2.1/2 in   | 1 | NSB106-80  |
| 2.9/16 in  | 1 | NSB106-82  |
| 2.5/8 in   | 1 | NSB106-84  |
| 2.3/4 in   | 1 | NSB106-88  |
| 2.13/16 in | 1 | NSB106-90  |
| 2.7/8 in   | 1 | NSB106-92  |
| 2.15/16 in | 1 | NSB106-94  |
| 3 in       | 1 | NSB106-96  |
| 3.1/16 in  | 1 | NSB106-98  |
| 3.1/8 in   | 1 | NSB106-100 |
| 3.1/4 in   | 1 | NSB106-104 |
| 3.3/8 in   | 1 | NSB106-108 |
| 3.1/2 in   | 1 | NSB106-112 |
| 3.9/16 in  | 1 | NSB106-114 |
| 3.5/8 in   | 1 | NSB106-116 |
| 3.3/4 in   | 1 | NSB106-120 |
| 3.7/8 in   | 1 | NSB106-124 |
| 3.15/16 in | 1 | NSB106-126 |
| 4 in       | 1 | NSB106-128 |
| 4.1/8 in   | 1 | NSB106-132 |
| 4.1/4 in   | 1 | NSB106-136 |
| 4.5/16 in  | 1 | NSB106-138 |
| 4.1/2 in   | 1 | NSB106-144 |
| 4.9/16 in  | 1 | NSB106-146 |
| 4.11/16 in | 1 | NSB106-150 |
| 4.7/8 in   | 1 | NSB106-156 |
| 4.15/16 in | 1 | NSB106-158 |

BAM/ZBF/003/21

## PIPE WRENCHES & VALVE TOOLS

Non-Sparking Heavy Duty Pipe Wrenches Aluminium Bronze



### NS200

| 25 mm  | 200 mm  | 1 NS200-200  |
|--------|---------|--------------|
| 30 mm  | 250 mm  | 1 NS200-250  |
| 40 mm  | 300 mm  | 1 NS200-300  |
| 50 mm  | 350 mm  | 1 NS200-350  |
| 60 mm  | 450 mm  | 1 NS200-450  |
| 75 mm  | 600 mm  | 1 NS200-600  |
| 85 mm  | 900 mm  | 1 NS200-900  |
| 110 mm | 1200 mm | 1 NS200-1200 |

BAM/ZBF/002/21

Non-Sparking Heavy Duty Pipe Wrenches Copper Beryllium



### NSB200

| 25 mm  | 200 mm  | 1 NSB200-200  |
|--------|---------|---------------|
| 30 mm  | 250 mm  | 1 NSB200-250  |
| 40 mm  | 300 mm  | 1 NSB200-300  |
| 50 mm  | 350 mm  | 1 NSB200-350  |
| 60 mm  | 450 mm  | 1 NSB200-450  |
| 75 mm  | 600 mm  | 1 NSB200-600  |
| 85 mm  | 900 mm  | 1 NSB200-900  |
| 110 mm | 1200 mm | 1 NSB200-1200 |

BAM/ZBF/003/21

Non-Sparking Long Valve Wrenches Aluminium Bronze



### NS202

| 370 mm | 1 | NS202-350 |
|--------|---|-----------|

BAM/ZBF/002/21

Non-Sparking Long Valve Wrenches Copper Beryllium



### NSB202

| 375 mm | 1 | NSB202-350 |
|--------|---|------------|

BAM/ZBF/003/21

Non-Sparking Valve Wrenches Aluminium Bronze



### NS203

| 215 mm | 24 mm | 1 NS203-200 |
|--------|-------|-------------|
| 215 mm | 32 mm | 1 NS203-215 |

| 290 mm | 36 mm | 1 NS203-290 |
|--------|-------|-------------|
| 400 mm | 48 mm | 1 NS203-400 |
| 490 mm | 60 mm | 1 NS203-490 |
| 800 mm | 60 mm | 1 NS203-800 |

BAM/ZBF/002/21

Non-Sparking Valve Wrenches Copper Beryllium



### NSB203

| 215 mm | 24 mm | 1 NSB203-200 |
|--------|-------|--------------|
| 215 mm | 32 mm | 1 NSB203-215 |
| 290 mm | 36 mm | 1 NSB203-290 |
| 400 mm | 48 mm | 1 NSB203-400 |
| 490 mm | 60 mm | 1 NSB203-490 |
| 800 mm | 60 mm | 1 NSB203-800 |

BAM/ZBF/003/21

Non-Sparking Valve Hooks Aluminium Bronze



### NS204

| 200 mm | 1 | NS204-30 |
|--------|---|----------|
| 300 mm | 1 | NS204-32 |
| 250 mm | 1 | NS204-35 |
| 300 mm | 1 | NS204-40 |
| 350 mm | 1 | NS204-45 |
| 375 mm | 1 | NS204-48 |
| 400 mm | 1 | NS204-50 |
| 450 mm | 1 | NS204-55 |
| 500 mm | 1 | NS204-60 |
| 550 mm | 1 | NS204-65 |
| 600 mm | 1 | NS204-70 |
| 650 mm | 1 | NS204-75 |
| 700 mm | 1 | NS204-80 |
| 750 mm | 1 | NS204-85 |
| 800 mm | 1 | NS204-90 |

BAM/ZBF/002/21



Non-Sparking Valve Hooks Copper Beryllium



**NSB204**

| Ø      | L |   |           |
|--------|---|---|-----------|
| 200 mm |   | 1 | NSB204-30 |
| 300 mm |   | 1 | NSB204-32 |
| 250 mm |   | 1 | NSB204-35 |
| 300 mm |   | 1 | NSB204-40 |
| 350 mm |   | 1 | NSB204-45 |
| 375 mm |   | 1 | NSB204-48 |
| 400 mm |   | 1 | NSB204-50 |
| 450 mm |   | 1 | NSB204-55 |
| 500 mm |   | 1 | NSB204-60 |
| 550 mm |   | 1 | NSB204-65 |
| 600 mm |   | 1 | NSB204-70 |
| 650 mm |   | 1 | NSB204-75 |
| 700 mm |   | 1 | NSB204-80 |
| 750 mm |   | 1 | NSB204-85 |
| 800 mm |   | 1 | NSB204-90 |

BAM/ZBF/003/21

| Ø     | L     |   |          |
|-------|-------|---|----------|
| 17 mm | 40 mm | 1 | NS220-17 |
| 18 mm | 42 mm | 1 | NS220-18 |
| 19 mm | 42 mm | 1 | NS220-19 |
| 20 mm | 42 mm | 1 | NS220-20 |
| 21 mm | 43 mm | 1 | NS220-21 |
| 22 mm | 43 mm | 1 | NS220-22 |
| 23 mm | 43 mm | 1 | NS220-23 |
| 24 mm | 43 mm | 1 | NS220-24 |
| 25 mm | 43 mm | 1 | NS220-25 |
| 26 mm | 43 mm | 1 | NS220-26 |
| 27 mm | 46 mm | 1 | NS220-27 |
| 28 mm | 46 mm | 1 | NS220-28 |
| 29 mm | 46 mm | 1 | NS220-29 |
| 30 mm | 46 mm | 1 | NS220-30 |
| 32 mm | 46 mm | 1 | NS220-32 |
| 34 mm | 50 mm | 1 | NS220-34 |
| 36 mm | 50 mm | 1 | NS220-36 |
| 41 mm | 55 mm | 1 | NS220-41 |

BAM/ZBF/002/21

Non-Sparking 1/2" Sockets with Metric Hex Profile Copper Beryllium



**NSB220**

| Ø     | L     |   |           |
|-------|-------|---|-----------|
| 6 mm  | 40 mm | 1 | NSB220-06 |
| 7 mm  | 40 mm | 1 | NSB220-07 |
| 8 mm  | 40 mm | 1 | NSB220-08 |
| 9 mm  | 40 mm | 1 | NSB220-09 |
| 10 mm | 40 mm | 1 | NSB220-10 |
| 11 mm | 40 mm | 1 | NSB220-11 |
| 12 mm | 40 mm | 1 | NSB220-12 |
| 13 mm | 41 mm | 1 | NSB220-13 |
| 14 mm | 40 mm | 1 | NSB220-14 |
| 15 mm | 40 mm | 1 | NSB220-15 |
| 16 mm | 40 mm | 1 | NSB220-16 |
| 17 mm | 41 mm | 1 | NSB220-17 |
| 18 mm | 42 mm | 1 | NSB220-18 |
| 19 mm | 42 mm | 1 | NSB220-19 |
| 20 mm | 42 mm | 1 | NSB220-20 |
| 21 mm | 43 mm | 1 | NSB220-21 |
| 22 mm | 43 mm | 1 | NSB220-22 |
| 23 mm | 44 mm | 1 | NSB220-23 |
| 24 mm | 43 mm | 1 | NSB220-24 |
| 25 mm | 44 mm | 1 | NSB220-25 |
| 26 mm | 43 mm | 1 | NSB220-26 |
| 27 mm | 47 mm | 1 | NSB220-27 |
| 28 mm | 46 mm | 1 | NSB220-28 |
| 29 mm | 47 mm | 1 | NSB220-29 |
| 30 mm | 46 mm | 1 | NSB220-30 |
| 32 mm | 47 mm | 1 | NSB220-32 |

BAM/ZBF/003/21

Non-Sparking 3/4" Sockets with Metric Hex Profile Aluminium Bronze



**NS224**

| Ø     | L     |   |          |
|-------|-------|---|----------|
| 17 mm | 50 mm | 1 | NS224-17 |
| 18 mm | 50 mm | 1 | NS224-18 |
| 19 mm | 50 mm | 1 | NS224-19 |
| 21 mm | 55 mm | 1 | NS224-21 |
| 22 mm | 55 mm | 1 | NS224-22 |
| 23 mm | 55 mm | 1 | NS224-23 |
| 24 mm | 55 mm | 1 | NS224-24 |
| 26 mm | 55 mm | 1 | NS224-26 |
| 27 mm | 55 mm | 1 | NS224-27 |
| 28 mm | 55 mm | 1 | NS224-28 |
| 29 mm | 55 mm | 1 | NS224-29 |
| 30 mm | 60 mm | 1 | NS224-30 |
| 32 mm | 60 mm | 1 | NS224-32 |
| 34 mm | 60 mm | 1 | NS224-34 |
| 36 mm | 60 mm | 1 | NS224-36 |
| 38 mm | 60 mm | 1 | NS224-38 |
| 41 mm | 65 mm | 1 | NS224-41 |
| 46 mm | 65 mm | 1 | NS224-46 |
| 50 mm | 70 mm | 1 | NS224-50 |

BAM/ZBF/002/21

Non-Sparking 3/4" Sockets with Metric Hex Profile Copper Beryllium



**NSB224**

| Ø     | L     |   |           |
|-------|-------|---|-----------|
| 17 mm | 50 mm | 1 | NSB224-17 |
| 18 mm | 50 mm | 1 | NSB224-18 |
| 19 mm | 50 mm | 1 | NSB224-19 |
| 21 mm | 55 mm | 1 | NSB224-21 |
| 22 mm | 55 mm | 1 | NSB224-22 |
| 23 mm | 55 mm | 1 | NSB224-23 |
| 24 mm | 56 mm | 1 | NSB224-24 |
| 26 mm | 55 mm | 1 | NSB224-26 |
| 27 mm | 55 mm | 1 | NSB224-27 |
| 28 mm | 55 mm | 1 | NSB224-28 |
| 29 mm | 55 mm | 1 | NSB224-29 |
| 30 mm | 60 mm | 1 | NSB224-30 |
| 32 mm | 61 mm | 1 | NSB224-32 |
| 34 mm | 60 mm | 1 | NSB224-34 |
| 36 mm | 61 mm | 1 | NSB224-36 |
| 38 mm | 60 mm | 1 | NSB224-38 |
| 41 mm | 66 mm | 1 | NSB224-41 |

**SOCKETS & RATCHETS**

Non-Sparking 1/2" Sockets with Metric Hex Profile Aluminium Bronze



**NS220**

| Ø     | L     |   |          |
|-------|-------|---|----------|
| 6 mm  | 40 mm | 1 | NS220-06 |
| 7 mm  | 40 mm | 1 | NS220-07 |
| 8 mm  | 40 mm | 1 | NS220-08 |
| 9 mm  | 40 mm | 1 | NS220-09 |
| 10 mm | 40 mm | 1 | NS220-10 |
| 11 mm | 40 mm | 1 | NS220-11 |
| 12 mm | 40 mm | 1 | NS220-12 |
| 13 mm | 40 mm | 1 | NS220-13 |
| 14 mm | 40 mm | 1 | NS220-14 |
| 15 mm | 40 mm | 1 | NS220-15 |
| 16 mm | 40 mm | 1 | NS220-16 |



| Ø     | L     | Icons | Part No.    |
|-------|-------|-------|-------------|
| 46 mm | 65 mm |       | 1 NSB224-46 |
| 50 mm | 71 mm |       | 1 NSB224-50 |

BAM/ZBF/003/21

Non-Sparking 1" Sockets with Metric Hex Profile Aluminium Bronze



NS228

| Ø     | L     | Icons | Part No.   |
|-------|-------|-------|------------|
| 22 mm | 55 mm |       | 1 NS228-22 |
| 24 mm | 55 mm |       | 1 NS228-24 |
| 26 mm | 55 mm |       | 1 NS228-26 |
| 27 mm | 55 mm |       | 1 NS228-27 |
| 28 mm | 55 mm |       | 1 NS228-28 |
| 29 mm | 55 mm |       | 1 NS228-29 |
| 30 mm | 60 mm |       | 1 NS228-30 |
| 31 mm | 60 mm |       | 1 NS228-31 |
| 32 mm | 60 mm |       | 1 NS228-32 |
| 34 mm | 60 mm |       | 1 NS228-34 |
| 36 mm | 65 mm |       | 1 NS228-36 |
| 38 mm | 65 mm |       | 1 NS228-38 |
| 41 mm | 70 mm |       | 1 NS228-41 |
| 46 mm | 75 mm |       | 1 NS228-46 |
| 50 mm | 75 mm |       | 1 NS228-50 |
| 55 mm | 80 mm |       | 1 NS228-55 |
| 60 mm | 85 mm |       | 1 NS228-60 |
| 65 mm | 90 mm |       | 1 NS228-65 |
| 70 mm | 90 mm |       | 1 NS228-70 |
| 75 mm | 95 mm |       | 1 NS228-75 |
| 80 mm | 95 mm |       | 1 NS228-80 |

BAM/ZBF/002/21

Non-Sparking 1" Sockets with Metric Hex Profile Copper Beryllium



NSB228

| Ø     | g     | Icons | Part No.    |
|-------|-------|-------|-------------|
| 22 mm | 370 g |       | 1 NSB228-22 |
| 24 mm | 430 g |       | 1 NSB228-24 |
| 26 mm | 396 g |       | 1 NSB228-26 |
| 27 mm | 440 g |       | 1 NSB228-27 |
| 28 mm | 411 g |       | 1 NSB228-28 |

| Ø     | g      | Icons | Part No.    |
|-------|--------|-------|-------------|
| 29 mm | 460 g  |       | 1 NSB228-29 |
| 30 mm | 462 g  |       | 1 NSB228-30 |
| 31 mm | 520 g  |       | 1 NSB228-31 |
| 32 mm | 497 g  |       | 1 NSB228-32 |
| 34 mm | 506 g  |       | 1 NSB228-34 |
| 36 mm | 610 g  |       | 1 NSB228-36 |
| 38 mm | 600 g  |       | 1 NSB228-38 |
| 41 mm | 740 g  |       | 1 NSB228-41 |
| 46 mm | 832 g  |       | 1 NSB228-46 |
| 50 mm | 960 g  |       | 1 NSB228-50 |
| 55 mm | 1130 g |       | 1 NSB228-55 |
| 60 mm | 1570 g |       | 1 NSB228-60 |
| 65 mm | 1698 g |       | 1 NSB228-65 |
| 70 mm | 2350 g |       | 1 NSB228-70 |
| 75 mm | 3010 g |       | 1 NSB228-75 |
| 80 mm | 2818 g |       | 1 NSB228-80 |

BAM/ZBF/003/21

Non-Sparking Adapters Aluminium Bronze



NS232

| Ø    | Ø    | Icons | Part No.      |
|------|------|-------|---------------|
| 1/2" | 3/4" |       | 1 NS232-16-24 |
| 3/4" | 1/2" |       | 1 NS232-24-16 |
| 3/4" | 1"   |       | 1 NS232-24-32 |
| 1"   | 3/4" |       | 1 NS232-32-24 |

BAM/ZBF/002/21

Non-Sparking Adapters Copper Beryllium



NSB232

| Ø    | Ø    | Icons | Part No.       |
|------|------|-------|----------------|
| 1/2" | 3/4" |       | 1 NSB232-16-24 |
| 3/4" | 1/2" |       | 1 NSB232-24-16 |
| 3/4" | 1"   |       | 1 NSB232-24-32 |
| 1"   | 3/4" |       | 1 NSB232-32-24 |

BAM/ZBF/003/21

Non-Sparking Extensions Aluminium Bronze



NS234

| Ø    | Ø    | Icons | Part No.       |
|------|------|-------|----------------|
| 1/2" | 1/2" |       | 1 NS234-16-100 |
| 1/2" | 1/2" |       | 1 NS234-16-200 |
| 1/2" | 1/2" |       | 1 NS234-16-250 |
| 3/4" | 3/4" |       | 1 NS234-24-200 |
| 1"   | 1"   |       | 1 NS234-32-250 |

BAM/ZBF/002/21

Non-Sparking Extensions Copper Beryllium



NSB234

| L      | Ø       | Icons | Part No.        |
|--------|---------|-------|-----------------|
| 100 mm | 16.4 mm |       | 1 NSB234-16-100 |
| 200 mm | 16.4 mm |       | 1 NSB234-16-200 |
| 250 mm | 16.4 mm |       | 1 NSB234-16-250 |
| 200 mm | 25 mm   |       | 1 NSB234-24-200 |
| 250 mm | 34 mm   |       | 1 NSB234-32-250 |

BAM/ZBF/003/21

Non-Sparking Universal Joints Aluminium Bronze



NS236

| Ø    | Ø    | Icons | Part No.   |
|------|------|-------|------------|
| 1/2" | 1/2" |       | 1 NS236-16 |
| 3/4" | 3/4" |       | 1 NS236-24 |
| 1"   | 1"   |       | 1 NS236-32 |

BAM/ZBF/002/21



Non-Sparking Universal Joints Copper Beryllium



**NSB236**

|      |      |   |           |
|------|------|---|-----------|
|      |      |   |           |
| 1/2" | 1/2" | 1 | NSB236-16 |
| 3/4" | 3/4" | 1 | NSB236-24 |
| 1"   | 1"   | 1 | NSB236-32 |

BAM/ZBF/003/21

Non-Sparking Sliding T-handles Aluminium Bronze



**NS238**

|      |        |   |              |
|------|--------|---|--------------|
|      |        |   |              |
| 1/2" | 250 mm | 1 | NS238-16-250 |
| 3/4" | 260 mm | 1 | NS238-24-250 |
| 1"   | 300 mm | 1 | NS238-32-300 |

BAM/ZBF/002/21

Non-Sparking Sliding T-handles Copper Beryllium



**NSB238**

|      |        |   |               |
|------|--------|---|---------------|
|      |        |   |               |
| 1/2" | 250 mm | 1 | NSB238-16-250 |
| 3/4" | 250 mm | 1 | NSB238-24-250 |
| 1"   | 300 mm | 1 | NSB238-32-300 |

BAM/ZBF/003/21

Non-Sparking Offset L-handles Aluminium Bronze



**NS240**

|      |        |   |              |
|------|--------|---|--------------|
|      |        |   |              |
| 1/2" | 230 mm | 1 | NS240-16-230 |

BAM/ZBF/002/21

Non-Sparking Offset L-handles Copper Beryllium



**NSB240**

|      |       |   |               |
|------|-------|---|---------------|
|      |       |   |               |
| 1/2" | 370 g | 1 | NSB240-16-230 |

BAM/ZBF/003/21

Non-Sparking Reversible Ratchets Aluminium Bronze



**NS242**

|      |        |   |          |
|------|--------|---|----------|
|      |        |   |          |
| 1/2" | 245 mm | 1 | NS242-16 |
| 3/4" | 320 mm | 1 | NS242-24 |
| 1"   | 550 mm | 1 | NS242-32 |

BAM/ZBF/002/21

Non-Sparking Reversible Ratchets Copper Beryllium



**NSB242**

|      |        |   |           |
|------|--------|---|-----------|
|      |        |   |           |
| 1/2" | 245 mm | 1 | NSB242-16 |
| 3/4" | 320 mm | 1 | NSB242-24 |
| 1"   | 550 mm | 1 | NSB242-32 |

BAM/ZBF/003/21

Non-Sparking Speed Handles Aluminium Bronze



**NS243**

|      |        |   |              |
|------|--------|---|--------------|
|      |        |   |              |
| 1/2" | 390 mm | 1 | NS243-16-400 |

BAM/ZBF/002/21

Non-Sparking Speed Handles Copper Beryllium



**NSB243**

|      |        |   |               |
|------|--------|---|---------------|
|      |        |   |               |
| 1/2" | 395 mm | 1 | NSB243-16-400 |

BAM/ZBF/003/21

Non-Sparking Spark Plug Sockets with Hex Profile Aluminium Bronze



**NS247**

|      |       |   |          |
|------|-------|---|----------|
|      |       |   |          |
| 1/2" | 13 mm | 1 | NS247-26 |

BAM/ZBF/002/21

Non-Sparking Spark Plug Sockets with Hex Profile Copper Beryllium



**NSB247**

|      |       |   |           |
|------|-------|---|-----------|
|      |       |   |           |
| 1/2" | 13 mm | 1 | NSB247-26 |

BAM/ZBF/003/21

Non-Sparking Screwdriver Sockets Aluminium Bronze



**NS248**

|       |   |             |
|-------|---|-------------|
|       |   |             |
| 13 mm | 1 | NS248-16-52 |

BAM/ZBF/002/21

Non-Sparking Screwdriver Sockets Copper Beryllium



**NSB248**

|       |   |              |
|-------|---|--------------|
|       |   |              |
| 13 mm | 1 | NSB248-16-52 |

BAM/ZBF/003/21

**SCREWDRIVERS**

ERGO™ Non-Sparking Slotted Screwdrivers Aluminium Bronze



**NS300**

|        |        |   |               |
|--------|--------|---|---------------|
|        |        |   |               |
| 3 mm   | 50 mm  | 1 | NS300-3-50    |
| 3 mm   | 75 mm  | 1 | NS300-3-75    |
| 4 mm   | 75 mm  | 1 | NS300-4-75    |
| 4.5 mm | 50 mm  | 1 | NS300-4.5-50  |
| 4.5 mm | 100 mm | 1 | NS300-4.5-100 |
| 5 mm   | 75 mm  | 1 | NS300-5-75    |
| 5 mm   | 100 mm | 1 | NS300-5-100   |
| 6 mm   | 100 mm | 1 | NS300-6-100   |
| 6 mm   | 125 mm | 1 | NS300-6-125   |
| 6 mm   | 150 mm | 1 | NS300-6-150   |
| 7 mm   | 150 mm | 1 | NS300-7-150   |
| 8 mm   | 150 mm | 1 | NS300-8-150   |
| 8 mm   | 200 mm | 1 | NS300-8-200   |
| 9 mm   | 250 mm | 1 | NS300-9-250   |
| 10 mm  | 200 mm | 1 | NS300-10-200  |
| 10 mm  | 300 mm | 1 | NS300-10-300  |
| 11 mm  | 250 mm | 1 | NS300-11-250  |
| 11 mm  | 300 mm | 1 | NS300-11-300  |
| 11 mm  | 350 mm | 1 | NS300-11-350  |
| 12 mm  | 400 mm | 1 | NS300-12-400  |
| 13 mm  | 450 mm | 1 | NS300-13-450  |

BAM/ZBF/002/21

ERGO™ Non-Sparking Slotted Screwdrivers Copper Beryllium



**NSB300**

|        |        |   |                |
|--------|--------|---|----------------|
|        |        |   |                |
| 3 mm   | 50 mm  | 1 | NSB300-3-50    |
| 3 mm   | 75 mm  | 1 | NSB300-3-75    |
| 4 mm   | 75 mm  | 1 | NSB300-4-75    |
| 4.5 mm | 60 mm  | 1 | NSB300-4.5-50  |
| 4.5 mm | 95 mm  | 1 | NSB300-4.5-100 |
| 5 mm   | 75 mm  | 1 | NSB300-5-75    |
| 5 mm   | 100 mm | 1 | NSB300-5-100   |
| 6 mm   | 105 mm | 1 | NSB300-6-100   |
| 6 mm   | 125 mm | 1 | NSB300-6-125   |
| 6 mm   | 160 mm | 1 | NSB300-6-150   |
| 7 mm   | 150 mm | 1 | NSB300-7-150   |
| 8 mm   | 150 mm | 1 | NSB300-8-150   |
| 8 mm   | 200 mm | 1 | NSB300-8-200   |
| 9 mm   | 250 mm | 1 | NSB300-9-250   |
| 9 mm   | 200 mm | 1 | NSB300-10-200  |
| 10 mm  | 318 mm | 1 | NSB300-10-300  |
| 11 mm  | 250 mm | 1 | NSB300-11-250  |
| 11 mm  | 300 mm | 1 | NSB300-11-300  |
| 11 mm  | 350 mm | 1 | NSB300-11-350  |
| 12 mm  | 400 mm | 1 | NSB300-12-400  |
| 13 mm  | 450 mm | 1 | NSB300-13-450  |

BAM/ZBF/003/21

ERGO™ Non-Sparking Electrician Flat Tipped Screwdrivers Aluminium Bronze



**NS301**

|       |        |   |              |
|-------|--------|---|--------------|
|       |        |   |              |
| 3 mm  | 50 mm  | 1 | NS301-3-50   |
| 4 mm  | 100 mm | 1 | NS301-4-100  |
| 4 mm  | 150 mm | 1 | NS301-4-150  |
| 5 mm  | 100 mm | 1 | NS301-5-100  |
| 5 mm  | 200 mm | 1 | NS301-5-200  |
| 6 mm  | 100 mm | 1 | NS301-6-100  |
| 8 mm  | 150 mm | 1 | NS301-8-150  |
| 10 mm | 200 mm | 1 | NS301-10-200 |
| 10 mm | 300 mm | 1 | NS301-10-300 |

BAM/ZBF/002/21



ERGO™ Non-Sparking Electrician Flat Tipped Screwdrivers Copper Beryllium



**NSB301**

| Tip Size | Length | Part No.        |
|----------|--------|-----------------|
| 3 mm     | 50 mm  | 1 NSB301-3-50   |
| 4 mm     | 100 mm | 1 NSB301-4-100  |
| 4 mm     | 150 mm | 1 NSB301-4-150  |
| 5 mm     | 100 mm | 1 NSB301-5-100  |
| 5 mm     | 210 mm | 1 NSB301-5-200  |
| 6 mm     | 100 mm | 1 NSB301-6-100  |
| 8 mm     | 155 mm | 1 NSB301-8-150  |
| 10 mm    | 200 mm | 1 NSB301-10-200 |
| 10 mm    | 300 mm | 1 NSB301-10-300 |

BAM/ZBF/003/21

ERGO™ Non-Sparking Phillips Screwdrivers Aluminium Bronze



**NS302**

| Tip Size | Length | Part No.      |
|----------|--------|---------------|
| PH0      | 50 mm  | 1 NS302-0-50  |
| PH1      | 100 mm | 1 NS302-1-100 |
| PH2      | 125 mm | 1 NS302-2-125 |
| PH3      | 150 mm | 1 NS302-3-150 |
| PH4      | 300 mm | 1 NS302-4-300 |

BAM/ZBF/002/21

ERGO™ Non-Sparking Phillips Screwdrivers Copper Beryllium



**NSB302**

| Tip Size | Length | Part No.       |
|----------|--------|----------------|
| PH0      | 65 mm  | 1 NSB302-0-50  |
| PH1      | 120 mm | 1 NSB302-1-100 |
| PH2      | 125 mm | 1 NSB302-2-125 |
| PH3      | 150 mm | 1 NSB302-3-150 |
| PH4      | 300 mm | 1 NSB302-4-300 |

BAM/ZBF/003/21

ERGO™ Non-Sparking Pozidriv Screwdrivers Aluminium Bronze



**NS304**

| Tip Size | Length | Part No.      |
|----------|--------|---------------|
| PZ0      | 50 mm  | 1 NS304-0-50  |
| PZ1      | 100 mm | 1 NS304-1-100 |
| PZ2      | 125 mm | 1 NS304-2-125 |
| PZ3      | 150 mm | 1 NS304-3-150 |
| PZ4      | 300 mm | 1 NS304-4-300 |

BAM/ZBF/002/21

ERGO™ Non-Sparking Pozidriv Screwdrivers Copper Beryllium



**NSB304**

| Tip Size | Length | Part No.       |
|----------|--------|----------------|
| PZ0      | 50 mm  | 1 NSB304-0-50  |
| PZ1      | 100 mm | 1 NSB304-1-100 |
| PZ2      | 125 mm | 1 NSB304-2-125 |
| PZ3      | 150 mm | 1 NSB304-3-150 |
| PZ4      | 300 mm | 1 NSB304-4-300 |

BAM/ZBF/003/21

Non-Sparking Offset Keys Aluminium Bronze



**NS320**

| Tip Size | Length | Part No.   |
|----------|--------|------------|
| 2 mm     | 59 mm  | 1 NS320-2  |
| 3 mm     | 59 mm  | 1 NS320-3  |
| 4 mm     | 65 mm  | 1 NS320-4  |
| 5 mm     | 79 mm  | 1 NS320-5  |
| 6 mm     | 85 mm  | 1 NS320-6  |
| 7 mm     | 88 mm  | 1 NS320-7  |
| 8 mm     | 92 mm  | 1 NS320-8  |
| 9 mm     | 99 mm  | 1 NS320-9  |
| 10 mm    | 110 mm | 1 NS320-10 |

BAM/ZBF/002/21

Non-Sparking Offset Keys Copper Beryllium



**NSB320**

| Tip Size | Length | Part No.    |
|----------|--------|-------------|
| 2 mm     | 59 mm  | 1 NSB320-2  |
| 3 mm     | 59 mm  | 1 NSB320-3  |
| 4 mm     | 65 mm  | 1 NSB320-4  |
| 5 mm     | 79 mm  | 1 NSB320-5  |
| 6 mm     | 85 mm  | 1 NSB320-6  |
| 7 mm     | 88 mm  | 1 NSB320-7  |
| 8 mm     | 93 mm  | 1 NSB320-8  |
| 9 mm     | 97 mm  | 1 NSB320-9  |
| 10 mm    | 110 mm | 1 NSB320-10 |

BAM/ZBF/003/21

**PLIERS**

Non-Sparking Combination Pliers Aluminium Bronze



**NS400**

| Length | Part No.    |
|--------|-------------|
| 155 mm | 1 NS400-160 |
| 175 mm | 1 NS400-180 |
| 200 mm | 1 NS400-200 |

BAM/ZBF/002/21

Non-Sparking Combination Pliers Copper Beryllium



**NSB400**

| Length | Part No.     |
|--------|--------------|
| 157 mm | 1 NSB400-160 |
| 175 mm | 1 NSB400-180 |
| 200 mm | 1 NSB400-200 |

BAM/ZBF/003/21



Non-Sparking Diagonal Cutting Pliers  
Aluminium Bronze



**NS402**



|        |   |           |
|--------|---|-----------|
| 150 mm | 1 | NS402-160 |
| 200 mm | 1 | NS402-200 |

BAM/ZBF/002/21

Non-Sparking Diagonal Cutting Pliers  
Copper Beryllium



**NSB402**



|        |   |            |
|--------|---|------------|
| 155 mm | 1 | NSB402-160 |
| 200 mm | 1 | NSB402-200 |

BAM/ZBF/003/21

Non-Sparking Heavy Duty Diagonal  
Cutting Pliers Aluminium Bronze



**NS403**



|        |   |           |
|--------|---|-----------|
| 150 mm | 1 | NS403-160 |
| 180 mm | 1 | NS403-180 |

BAM/ZBF/002/21

Non-Sparking Heavy Duty Diagonal  
Cutting Pliers Copper Beryllium



**NSB403**



|        |   |            |
|--------|---|------------|
| 155 mm | 1 | NSB403-160 |
| 180 mm | 1 | NSB403-180 |

BAM/ZBF/003/21

Non-Sparking Long Flat Nose Pliers  
Aluminium Bronze



**NS404**



|        |   |           |
|--------|---|-----------|
| 150 mm | 1 | NS404-160 |
|--------|---|-----------|

BAM/ZBF/002/21

Non-Sparking Long Flat Nose Pliers  
Copper Beryllium



**NSB404**



|        |   |            |
|--------|---|------------|
| 155 mm | 1 | NSB404-160 |
|--------|---|------------|

BAM/ZBF/003/21

Non-Sparking Round Nose Pliers  
Aluminium Bronze



**NS405**



|        |   |           |
|--------|---|-----------|
| 160 mm | 1 | NS405-160 |
|--------|---|-----------|

BAM/ZBF/002/21

Non-Sparking Round Nose Pliers Copper  
Beryllium



**NSB405**



|        |   |            |
|--------|---|------------|
| 155 mm | 1 | NSB405-160 |
|--------|---|------------|

BAM/ZBF/003/21

Non-Sparking Long Nose Pliers Aluminium  
Bronze



**NS406**



|        |   |           |
|--------|---|-----------|
| 160 mm | 1 | NS406-160 |
| 180 mm | 1 | NS406-180 |
| 200 mm | 1 | NS406-200 |

BAM/ZBF/002/21

Non-Sparking Long Nose Pliers Copper  
Beryllium



**NSB406**



|        |   |            |
|--------|---|------------|
| 155 mm | 1 | NSB406-160 |
| 180 mm | 1 | NSB406-180 |
| 200 mm | 1 | NSB406-200 |

BAM/ZBF/003/21

Non-Sparking Wire Strippers Aluminium  
Bronze



**NS407**



|        |   |           |
|--------|---|-----------|
| 170 mm | 1 | NS407-160 |
|--------|---|-----------|

BAM/ZBF/002/21



Non-Sparking Wire Strippers Copper Beryllium



**NSB407**

|        |              |
|--------|--------------|
|        |              |
| 170 mm | 1 NSB407-160 |

BAM/ZBF/003/21

Non-Sparking Groove Joint Pliers Aluminium Bronze



**NS408**

|        |             |
|--------|-------------|
|        |             |
| 260 mm | 1 NS408-250 |
| 300 mm | 1 NS408-300 |

BAM/ZBF/002/21

Non-Sparking Groove Joint Pliers Copper Beryllium



**NSB408**

|        |              |
|--------|--------------|
|        |              |
| 255 mm | 1 NSB408-250 |
| 300 mm | 1 NSB408-300 |

BAM/ZBF/003/21

Non-Sparking Slip Joint Pliers Aluminium Bronze



**NS412**

|        |             |
|--------|-------------|
|        |             |
| 200 mm | 1 NS412-200 |

BAM/ZBF/002/21

Non-Sparking Slip Joint Pliers Copper Beryllium



**NSB412**

|        |              |
|--------|--------------|
|        |              |
| 200 mm | 1 NSB412-200 |

BAM/ZBF/003/21

Non-Sparking Gas Pliers Aluminium Bronze



**NS411**

|        |             |
|--------|-------------|
|        |             |
| 200 mm | 1 NS411-200 |

BAM/ZBF/002/21

Non-Sparking Gas Pliers Copper Beryllium



**NSB411**

|        |              |
|--------|--------------|
|        |              |
| 205 mm | 1 NSB411-200 |

BAM/ZBF/003/21

Non-Sparking Carpenter's Pincers Aluminium Bronze



**NS413**

|        |             |
|--------|-------------|
|        |             |
| 180 mm | 1 NS413-180 |
| 195 mm | 1 NS413-200 |

BAM/ZBF/002/21

Non-Sparking Carpenter's Pincers Copper Beryllium



**NSB413**

|        |              |
|--------|--------------|
|        |              |
| 185 mm | 1 NSB413-180 |
| 195 mm | 1 NSB413-200 |

BAM/ZBF/003/21

## HAMMERS, PRY BARS & CHISELS

Non-Sparking Stoning Hammers with Aluminium Bronze Head and Wooden Handle



**NS500**

|        |              |
|--------|--------------|
|        |              |
| 2000 g | 1 NS500-2000 |
| 2500 g | 1 NS500-2500 |
| 3000 g | 1 NS500-3000 |
| 4000 g | 1 NS500-4000 |

BAM/ZBF/002/21

Non-Sparking Stoning Hammers with Copper Beryllium Head and Wooden Handle



**NSB500**

|        |               |
|--------|---------------|
|        |               |
| 2000 g | 1 NSB500-2000 |
| 2500 g | 1 NSB500-2500 |
| 3000 g | 1 NSB500-3000 |
| 4000 g | 1 NSB500-4000 |

BAM/ZBF/003/21

Non-Sparking Stoning Hammers with Aluminium Bronze Head and Fibreglass Handle



**NS500-FB**

| Weight (g) | Quantity | Model         |
|------------|----------|---------------|
| 1000 g     | 1        | NS500-1000-FB |
| 1500 g     | 1        | NS500-1500-FB |
| 2000 g     | 1        | NS500-2000-FB |
| 2500 g     | 1        | NS500-2500-FB |
| 3000 g     | 1        | NS500-3000-FB |
| 3500 g     | 1        | NS500-3500-FB |

BAM/ZBF/002/21

Non-Sparking Stoning Hammers with Copper Beryllium Head and Fibreglass Handle



**NSB500-FB**

| Weight (g) | Quantity | Model          |
|------------|----------|----------------|
| 1000 g     | 1        | NSB500-1000-FB |
| 1500 g     | 1        | NSB500-1500-FB |
| 2000 g     | 1        | NSB500-2000-FB |
| 2500 g     | 1        | NSB500-2500-FB |
| 3000 g     | 1        | NSB500-3000-FB |
| 3500 g     | 1        | NSB500-3500-FB |

BAM/ZBF/003/21

Non-Sparking Sledge Hammers with Aluminium Bronze Head and Fibreglass Handle



**NS502-FB**

| Weight (g) | Quantity | Model         |
|------------|----------|---------------|
| 450 g      | 1        | NS502-450-FB  |
| 1000 g     | 1        | NS502-1000-FB |
| 1500 g     | 1        | NS502-1500-FB |
| 2000 g     | 1        | NS502-2000-FB |
| 2500 g     | 1        | NS502-2500-FB |

| Weight (g) | Quantity | Model          |
|------------|----------|----------------|
| 3000 g     | 1        | NS502-3000-FB  |
| 4500 g     | 1        | NS502-4500-FB  |
| 5000 g     | 1        | NS502-5000-FB  |
| 6800 g     | 1        | NS502-6800-FB  |
| 8000 g     | 1        | NS502-8000-FB  |
| 10000 g    | 1        | NS502-10000-FB |
| 12000 g    | 1        | NS502-12000-FB |

BAM/ZBF/002/21

Non-Sparking Sledge Hammers with Copper Beryllium Head and Fibreglass Handle



**NSB502-FB**

| Weight (g) | Quantity | Model           |
|------------|----------|-----------------|
| 450 g      | 1        | NSB502-450-FB   |
| 1000 g     | 1        | NSB502-1000-FB  |
| 1500 g     | 1        | NSB502-1500-FB  |
| 2000 g     | 1        | NSB502-2000-FB  |
| 2500 g     | 1        | NSB502-2500-FB  |
| 3000 g     | 1        | NSB502-3000-FB  |
| 4500 g     | 1        | NSB502-4500-FB  |
| 5000 g     | 1        | NSB502-5000-FB  |
| 6800 g     | 1        | NSB502-6800-FB  |
| 8000 g     | 1        | NSB502-8000-FB  |
| 10000 g    | 1        | NSB502-10000-FB |
| 12000 g    | 1        | NSB502-12000-FB |

BAM/ZBF/003/21

Non-Sparking Machinist's Hammers with Aluminium Bronze Head and Fibreglass Handle



**NS504-FB**

| Weight (g) | Quantity | Model         |
|------------|----------|---------------|
| 100 g      | 1        | NS504-100-FB  |
| 200 g      | 1        | NS504-200-FB  |
| 300 g      | 1        | NS504-300-FB  |
| 500 g      | 1        | NS504-500-FB  |
| 800 g      | 1        | NS504-800-FB  |
| 1000 g     | 1        | NS504-1000-FB |
| 1500 g     | 1        | NS504-1500-FB |
| 2000 g     | 1        | NS504-2000-FB |

BAM/ZBF/002/21

Non-Sparking Machinist's Hammers with Copper Beryllium Head and Fibreglass Handle



**NSB504-FB**

| Weight (g) | Quantity | Model          |
|------------|----------|----------------|
| 100 g      | 1        | NSB504-100-FB  |
| 200 g      | 1        | NSB504-200-FB  |
| 300 g      | 1        | NSB504-300-FB  |
| 500 g      | 1        | NSB504-500-FB  |
| 800 g      | 1        | NSB504-800-FB  |
| 1000 g     | 1        | NSB504-1000-FB |
| 1500 g     | 1        | NSB504-1500-FB |
| 2000 g     | 1        | NSB504-2000-FB |

BAM/ZBF/003/21

Non-Sparking Ball Pein Hammers with Aluminium Bronze Head and Wooden Handle



**NS506**

| Weight (g) | Quantity | Model     |
|------------|----------|-----------|
| 340 g      | 1        | NS506-300 |
| 450 g      | 1        | NS506-450 |
| 670 g      | 1        | NS506-700 |
| 910 g      | 1        | NS506-900 |

BAM/ZBF/002/21

Non-Sparking Ball Pein Hammers with Copper Beryllium Head and Wooden Handle



**NSB506**

| Weight (g) | Quantity | Model      |
|------------|----------|------------|
| 300 g      | 1        | NSB506-300 |
| 450 g      | 1        | NSB506-450 |
| 680 g      | 1        | NSB506-700 |
| 910 g      | 1        | NSB506-900 |

BAM/ZBF/003/21



Non-Sparking Ball Pein Hammers with Aluminium Bronze Head and Fibreglass Handle



**NS506-FB**

| Weight | Part Number    |
|--------|----------------|
| 310 g  | 1 NS506-300-FB |
| 470 g  | 1 NS506-450-FB |
| 700 g  | 1 NS506-700-FB |
| 910 g  | 1 NS506-900-FB |

BAM/ZBF/002/21

Non-Sparking Ball Pein Hammers with Copper Beryllium Head and Fibreglass Handle



**NSB506-FB**

| Weight | Part Number     |
|--------|-----------------|
| 300 g  | 1 NSB506-300-FB |
| 450 g  | 1 NSB506-450-FB |
| 680 g  | 1 NSB506-700-FB |
| 900 g  | 1 NSB506-900-FB |

BAM/ZBF/003/21

Non-Sparking Claw Hammers with Aluminium Bronze Head and Fibreglass Handle



**NS508-FB**

| Weight | Part Number    |
|--------|----------------|
| 500 g  | 1 NS508-500-FB |
| 700 g  | 1 NS508-700-FB |

BAM/ZBF/002/21

Non-Sparking Claw Hammers with Copper Beryllium Head and Fibreglass Handle



**NSB508-FB**

| Weight | Part Number     |
|--------|-----------------|
| 500 g  | 1 NSB508-500-FB |
| 700 g  | 1 NSB508-700-FB |

BAM/ZBF/003/21

Non-Sparking Chipping Hammers with Aluminium Bronze Head and Fibreglass Handle



**NS512-FB**

| Weight | Part Number    |
|--------|----------------|
| 230 g  | 1 NS512-200-FB |
| 400 g  | 1 NS512-400-FB |
| 640 g  | 1 NS512-600-FB |
| 970 g  | 1 NS512-900-FB |

BAM/ZBF/002/21

Non-Sparking Chipping Hammers with Copper Beryllium Head and Fibreglass Handle



**NSB512-FB**

| Weight | Part Number     |
|--------|-----------------|
| 200 g  | 1 NSB512-200-FB |
| 400 g  | 1 NSB512-400-FB |
| 600 g  | 1 NSB512-600-FB |
| 900 g  | 1 NSB512-900-FB |

BAM/ZBF/003/21

Non-Sparking Wedges Aluminium Bronze



**NS600**

| Length | Part Number    |
|--------|----------------|
| 80 mm  | 1 NS600-80-13  |
| 100 mm | 1 NS600-100-50 |
| 135 mm | 1 NS600-135-50 |
| 150 mm | 1 NS600-150-25 |
| 150 mm | 1 NS600-150-30 |
| 150 mm | 1 NS600-150-40 |
| 150 mm | 1 NS600-150-50 |
| 180 mm | 1 NS600-180-13 |
| 180 mm | 1 NS600-180-32 |
| 180 mm | 1 NS600-180-50 |
| 200 mm | 1 NS600-200-20 |
| 200 mm | 1 NS600-200-30 |
| 200 mm | 1 NS600-200-40 |
| 200 mm | 1 NS600-200-50 |
| 230 mm | 1 NS600-230-40 |
| 250 mm | 1 NS600-250-40 |
| 300 mm | 1 NS600-300-50 |

BAM/ZBF/002/21

Non-Sparking Wedges Copper Beryllium



**NSB600**

| Length | Part Number     |
|--------|-----------------|
| 80 mm  | 1 NSB600-80-13  |
| 100 mm | 1 NSB600-100-50 |
| 135 mm | 1 NSB600-135-50 |
| 150 mm | 1 NSB600-150-25 |
| 150 mm | 1 NSB600-150-30 |
| 150 mm | 1 NSB600-150-40 |
| 150 mm | 1 NSB600-150-50 |
| 180 mm | 1 NSB600-180-13 |
| 180 mm | 1 NSB600-180-32 |
| 180 mm | 1 NSB600-180-50 |
| 200 mm | 1 NSB600-200-20 |
| 200 mm | 1 NSB600-200-30 |
| 200 mm | 1 NSB600-200-40 |
| 200 mm | 1 NSB600-200-50 |
| 230 mm | 1 NSB600-230-40 |
| 250 mm | 1 NSB600-250-40 |
| 300 mm | 1 NSB600-300-50 |

BAM/ZBF/003/21



Non-Sparking Wrecking Bars Aluminium  
Bronze



**NS602**

| Ø     | L      | Icon 1 | Icon 2    |
|-------|--------|--------|-----------|
| 16 mm | 460 mm | 1      | NS602-460 |
| 20 mm | 600 mm | 1      | NS602-600 |
| 22 mm | 760 mm | 1      | NS602-760 |
| 22 mm | 935 mm | 1      | NS602-900 |

BAM/ZBF/002/21

Non-Sparking Cross Cutting Chisels  
Copper Beryllium



**NSB604**

| L      | Icon 1 | Icon 2     |
|--------|--------|------------|
| 140 mm | 1      | NSB604-150 |
| 200 mm | 1      | NSB604-200 |
| 300 mm | 1      | NSB604-300 |

BAM/ZBF/003/21

Non-Sparking Centre Punches Aluminium  
Bronze



**NS608**

| L      | Icon 1 | Icon 2    |
|--------|--------|-----------|
| 100 mm | 1      | NS608-100 |

BAM/ZBF/002/21

Non-Sparking Wrecking Bars Copper  
Beryllium



**NSB6028**

| Ø     | L      | Icon 1 | Icon 2     |
|-------|--------|--------|------------|
| 16 mm | 460 mm | 1      | NSB602-460 |
| 20 mm | 600 mm | 1      | NSB602-600 |
| 22 mm | 760 mm | 1      | NSB602-760 |
| 22 mm | 920 mm | 1      | NSB602-900 |

BAM/ZBF/003/21

Non-Sparking Flat Chisels Aluminium  
Bronze



**NS606**

| L      | Icon 1 | Icon 2    |
|--------|--------|-----------|
| 150 mm | 1      | NS606-150 |
| 200 mm | 1      | NS606-200 |
| 250 mm | 1      | NS606-250 |
| 300 mm | 1      | NS606-300 |
| 400 mm | 1      | NS606-400 |

BAM/ZBF/002/21

Non-Sparking Centre Punches Copper  
Beryllium



**NSB608**

| L      | Icon 1 | Icon 2     |
|--------|--------|------------|
| 100 mm | 1      | NSB608-100 |

BAM/ZBF/003/21

Non-Sparking Cross Cutting Chisels  
Aluminium Bronze



**NS604**

| L      | Icon 1 | Icon 2    |
|--------|--------|-----------|
| 140 mm | 1      | NS604-150 |
| 200 mm | 1      | NS604-200 |
| 300 mm | 1      | NS604-300 |

BAM/ZBF/002/21

Non-Sparking Flat Chisels Copper  
Beryllium



**NSB606**

| L      | Icon 1 | Icon 2     |
|--------|--------|------------|
| 150 mm | 1      | NSB606-150 |
| 200 mm | 1      | NSB606-200 |
| 250 mm | 1      | NSB606-250 |
| 300 mm | 1      | NSB606-300 |
| 400 mm | 1      | NSB606-400 |

BAM/ZBF/003/21

**SCRAPERS**

Non-Sparking Angled Scrapers Aluminium  
Bronze



**NS700**

| Ø     | L      | Icon 1 | Icon 2    |
|-------|--------|--------|-----------|
| 45 mm | 300 mm | 1      | NS700-300 |

BAM/ZBF/002/21



Non-Sparking Angled Scrapers Copper  
Beryllium



**NSB700**

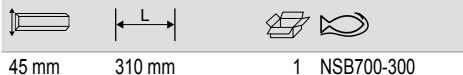

45 mm 310 mm 1 NSB700-300

BAM/ZBF/003/21

Non-Sparking Long Blade Scrapers  
Aluminium Bronze



**NS704**

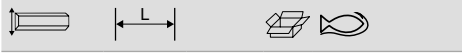

100 mm 720 mm 1 NS704-225

BAM/ZBF/002/21

Non-Sparking Flexible Scrapers Copper  
Beryllium



**NSB706**

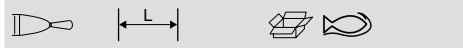

50 mm 200 mm 1 NSB706-50  
80 mm 200 mm 1 NSB706-80

BAM/ZBF/003/21

Non-Sparking Flat Scrapers Aluminium  
Bronze



**NS702**

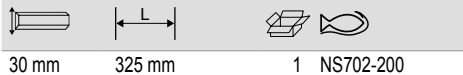

30 mm 325 mm 1 NS702-200

BAM/ZBF/002/21

Non-Sparking Long Blade Scrapers  
Copper Beryllium



**NSB704**

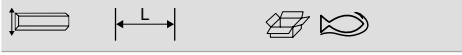

100 mm 720 mm 1 NSB704-225

BAM/ZBF/003/21

Non-Sparking Three-Square Scrapers  
Aluminium Bronze



**NS708**

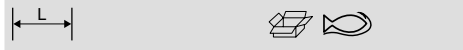

440 mm 1 NS708-360

BAM/ZBF/002/21

Non-Sparking Flat Scrapers Copper  
Beryllium



**NSB702**

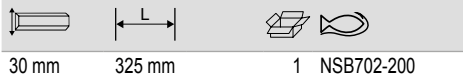

30 mm 325 mm 1 NSB702-200

BAM/ZBF/003/21

Non-Sparking Flexible Scrapers Aluminium  
Bronze



**NS706**

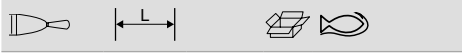

50 mm 200 mm 1 NS706-50  
80 mm 200 mm 1 NS706-80

BAM/ZBF/002/21

Non-Sparking Three-Square Scrapers  
Copper Beryllium



**NSB708**

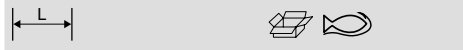

450 mm 1 NSB708-360

BAM/ZBF/003/21

Non-Sparking Triangular Ship Scrapers  
Aluminium Bronze



**NS710**

|        |   |           |
|--------|---|-----------|
|        |   |           |
| 470 mm | 1 | NS710-450 |

BAM/ZBF/002/21

Non-Sparking Triangular Ship Scrapers  
Copper Beryllium



**NSB710**

|        |   |            |
|--------|---|------------|
|        |   |            |
| 470 mm | 1 | NSB710-450 |

BAM/ZBF/003/21

**DIGGING TOOLS**

Non-Sparking Pickaxes Aluminium Bronze



**NS800**

|        |   |            |
|--------|---|------------|
|        |   |            |
| 910 mm | 1 | NS800-1100 |
| 910 mm | 1 | NS800-1700 |
| 965 mm | 1 | NS800-2000 |

BAM/ZBF/002/21

Non-Sparking Pickaxes Copper Beryllium



**NSB800**

|        |        |   |             |
|--------|--------|---|-------------|
|        |        |   |             |
| 910 mm | 2000 g | 1 | NSB800-1100 |
| 910 mm | 2800 g | 1 | NSB800-1700 |
| 910 mm | 3200 g | 1 | NSB800-2000 |

BAM/ZBF/003/21

Non-Sparking Round Shovels Aluminium  
Bronze



**NS802**

|         |   |           |
|---------|---|-----------|
|         |   |           |
| 1370 mm | 1 | NS802-290 |

BAM/ZBF/002/21

Non-Sparking Round Shovels Copper  
Beryllium



**NSB802**

|         |   |            |
|---------|---|------------|
|         |   |            |
| 1450 mm | 1 | NSB802-290 |

BAM/ZBF/003/21

Non-Sparking Hand Brushes Brass



**NS804**

|        |   |           |
|--------|---|-----------|
|        |   |           |
| 290 mm | 1 | NS804-290 |

BAM/ZBF/002/21

**EXTRACTORS & PULLERS**

Non-Sparking 3-Jaws Reversible Pullers  
Aluminium Bronze



**NS810**

|           |        |   |           |
|-----------|--------|---|-----------|
|           |        |   |           |
| 50-100 mm | 105 mm | 1 | NS810-100 |
| 60-150 mm | 175 mm | 1 | NS810-150 |
| 70-200 mm | 250 mm | 1 | NS810-200 |
| 80-350 mm | 320 mm | 1 | NS810-350 |

BAM/ZBF/002/21

Non-Sparking 3-Jaws Reversible Pullers  
Copper Beryllium



**NSB810**

|           |        |   |            |
|-----------|--------|---|------------|
|           |        |   |            |
| 50-100 mm | 105 mm | 1 | NSB810-100 |
| 60-150 mm | 175 mm | 1 | NSB810-150 |
| 70-200 mm | 250 mm | 1 | NSB810-200 |
| 80-350 mm | 320 mm | 1 | NSB810-350 |

BAM/ZBF/003/21



## TORQUE TOOLS

Non-Sparking Mechanical Adjustable Torque Click Wrenches with Window Scale and Fixed Ratchet Head in Aluminium Bronze



### NS041



|      |             |   |              |
|------|-------------|---|--------------|
| 1/4" | 5-25 N·m    | 1 | NS041-8-25   |
| 3/8" | 10-50 N·m   | 1 | NS041-12-50  |
| 1/2" | 20-100 N·m  | 1 | NS041-16-100 |
| 1/2" | 40-200 N·m  | 1 | NS041-16-200 |
| 1/2" | 60-260 N·m  | 1 | NS041-16-260 |
| 3/4" | 150-670 N·m | 1 | NS041-24-670 |
| 1"   | 200-900 N·m | 1 | NS041-32-900 |

BAM/ZBF/002/21

Non-Sparking Mechanical Adjustable Torque Click Wrenches with Window Scale and Fixed Ratchet Head in Copper Beryllium



### NSB041



|      |             |   |               |
|------|-------------|---|---------------|
| 1/4" | 5-25 N·m    | 1 | NSB041-8-25   |
| 3/8" | 10-50 N·m   | 1 | NSB041-12-50  |
| 1/2" | 20-100 N·m  | 1 | NSB041-16-100 |
| 1/2" | 40-200 N·m  | 1 | NSB041-16-200 |
| 1/2" | 60-260 N·m  | 1 | NSB041-16-260 |
| 3/4" | 150-670 N·m | 1 | NSB041-24-670 |
| 1"   | 200-900 N·m | 1 | NSB041-32-900 |

BAM/ZBF/003/21





## Stainless Steel Tools



## WRENCHES

Stainless Steel Central Nut Adjustable Wrenches



### SS001

| Length    | Width | Weight | Part No.  |
|-----------|-------|--------|-----------|
| 100mm/4"  | 13 mm | 1      | SS001-100 |
| 150mm/6"  | 18 mm | 1      | SS001-150 |
| 200mm/8"  | 24 mm | 1      | SS001-200 |
| 250mm/10" | 30 mm | 1      | SS001-250 |
| 300mm/12" | 36 mm | 1      | SS001-300 |
| 375mm/15" | 46 mm | 1      | SS001-375 |
| 450mm/18" | 55 mm | 1      | SS001-450 |
| 600mm/24" | 60 mm | 1      | SS001-600 |

Stainless Steel Metric Offset Combination Wrenches



### SS002

| Length | Weight | Part No. |
|--------|--------|----------|
| 7 in   | 1      | SS002-7  |
| 6 mm   | 1      | SS002-6  |
| 8 mm   | 1      | SS002-8  |
| 10 mm  | 1      | SS002-10 |
| 11 mm  | 1      | SS002-11 |
| 12 mm  | 1      | SS002-12 |
| 13 mm  | 1      | SS002-13 |
| 14 mm  | 1      | SS002-14 |
| 15 mm  | 1      | SS002-15 |
| 16 mm  | 1      | SS002-16 |
| 17 mm  | 1      | SS002-17 |
| 19 mm  | 1      | SS002-19 |
| 21 mm  | 1      | SS002-21 |
| 22 mm  | 1      | SS002-22 |
| 24 mm  | 1      | SS002-24 |
| 27 mm  | 1      | SS002-27 |
| 32 mm  | 1      | SS002-32 |

Stainless Steel Metric Combination Wrench Set - 6 Pcs



### SS002-6-2

| Quantity | Weight | Part No.    |
|----------|--------|-------------|
| 6        | 710 g  | 1 SS002-6-2 |

SS002-8, SS002-10, SS002-12, SS002-14, SS002-17, SS002-19

Stainless Steel Metric Combination Wrench Set - 9 Pcs



### SS002-9-2

| Quantity | Weight | Part No.    |
|----------|--------|-------------|
| 9        | 924 g  | 1 SS002-9-2 |

SS002-8, SS002-10, SS002-11, SS002-12, SS002-13, SS002-14, SS002-15, SS002-17, SS002-19

Stainless Steel Imperial Combination Wrenches



### SS003

| Length   | Weight | Part No.   |
|----------|--------|------------|
| 1/4 in   | 105 mm | 1 SS003-8  |
| 5/16 in  | 120 mm | 1 SS003-10 |
| 11/32 in | 135 mm | 1 SS003-11 |
| 3/8 in   | 135 mm | 1 SS003-12 |
| 7/16 in  | 150 mm | 1 SS003-14 |
| 1/2 in   | 175 mm | 1 SS003-16 |
| 9/16 in  | 175 mm | 1 SS003-18 |
| 5/8 in   | 195 mm | 1 SS003-20 |
| 11/16 in | 195 mm | 1 SS003-22 |

| Length   | Weight | Part No.   |
|----------|--------|------------|
| 3/4 in   | 215 mm | 1 SS003-24 |
| 25/32 in | 215 mm | 1 SS003-25 |
| 13/16 in | 245 mm | 1 SS003-26 |
| 7/8 in   | 245 mm | 1 SS003-28 |
| 15/16 in | 265 mm | 1 SS003-30 |

Stainless Steel Metric Double Ring End Offset Wrenches



### SS011

| Length   | Weight | Part No.     |
|----------|--------|--------------|
| 5.5*7 mm | 180 mm | 1 SS011-0507 |
| 6*7 mm   | 180 mm | 1 SS011-0607 |
| 8*9 mm   | 190 mm | 1 SS011-0809 |
| 8*10 mm  | 190 mm | 1 SS011-0810 |
| 9*11 mm  | 215 mm | 1 SS011-0911 |
| 10*12 mm | 215 mm | 1 SS011-1012 |
| 12*14 mm | 225 mm | 1 SS011-1214 |
| 14*17 mm | 255 mm | 1 SS011-1417 |
| 16*18 mm | 280 mm | 1 SS011-1618 |
| 17*19 mm | 280 mm | 1 SS011-1719 |
| 17*22 mm | 300 mm | 1 SS011-1722 |
| 22*24 mm | 330 mm | 1 SS011-2224 |
| 24*27 mm | 340 mm | 1 SS011-2427 |
| 24*30 mm | 350 mm | 1 SS011-2430 |
| 30*32 mm | 370 mm | 1 SS011-3032 |

Stainless steel double ring end offset wrenches sets, mm. 9 pieces



### SS011-9-3

| Quantity | Weight | Part No.    |
|----------|--------|-------------|
| 9        | 2470 g | 1 SS011-9-3 |

SS011-0810, SS011-1012, SS011-1214, SS011-1417, SS011-1719, SS011-1722, SS011-2224, SS011-2427, SS011-3032

Stainless steel double ring end offset wrenches sets, mm. 11 pieces



**SS011-11-3**

|    |        |   |            |
|----|--------|---|------------|
|    |        |   |            |
| 11 | 3100 g | 1 | SS011-11-3 |

SS011-0810, SS011-0911, SS011-1012, SS011-1214, SS011-1417, SS011-1719, SS011-1722, SS011-2224, SS011-2427, SS011-2430, SS011-3032

**SOCKETS & RATCHETS**

1/4" Square Drive Stainless Steel Sockets with Metric Hex Profile



**SS210**

| 4 mm   | 25 mm | 1 | SS210-4   |
|--------|-------|---|-----------|
| 4.5 mm | 25 mm | 1 | SS210-4.5 |
| 5 mm   | 25 mm | 1 | SS210-5   |
| 5.5 mm | 25 mm | 1 | SS210-5.5 |
| 6 mm   | 25 mm | 1 | SS210-6   |
| 7 mm   | 25 mm | 1 | SS210-7   |
| 8 mm   | 25 mm | 1 | SS210-8   |
| 9 mm   | 25 mm | 1 | SS210-9   |
| 10 mm  | 25 mm | 1 | SS210-10  |
| 11 mm  | 25 mm | 1 | SS210-11  |
| 12 mm  | 26 mm | 1 | SS210-12  |
| 13 mm  | 26 mm | 1 | SS210-13  |
| 14 mm  | 26 mm | 1 | SS210-14  |

1/2" Square Drive Stainless Steel Sockets with Metric Hex Profile



**SS220**

| 8 mm  | 40 mm | 1 | SS220-8  |
|-------|-------|---|----------|
| 9 mm  | 40 mm | 1 | SS220-9  |
| 10 mm | 40 mm | 1 | SS220-10 |

| 11 mm | 40 mm | 1 | SS220-11 |
|-------|-------|---|----------|
| 12 mm | 40 mm | 1 | SS220-12 |
| 13 mm | 40 mm | 1 | SS220-13 |
| 14 mm | 40 mm | 1 | SS220-14 |
| 15 mm | 40 mm | 1 | SS220-15 |
| 16 mm | 40 mm | 1 | SS220-16 |
| 17 mm | 40 mm | 1 | SS220-17 |
| 18 mm | 42 mm | 1 | SS220-18 |
| 19 mm | 42 mm | 1 | SS220-19 |
| 20 mm | 42 mm | 1 | SS220-20 |
| 21 mm | 43 mm | 1 | SS220-21 |
| 22 mm | 43 mm | 1 | SS220-22 |
| 23 mm | 43 mm | 1 | SS220-23 |
| 24 mm | 43 mm | 1 | SS220-24 |
| 25 mm | 43 mm | 1 | SS220-25 |
| 26 mm | 43 mm | 1 | SS220-26 |
| 27 mm | 46 mm | 1 | SS220-27 |
| 28 mm | 46 mm | 1 | SS220-28 |
| 29 mm | 46 mm | 1 | SS220-29 |
| 30 mm | 46 mm | 1 | SS220-30 |
| 31 mm | 46 mm | 1 | SS220-31 |
| 32 mm | 46 mm | 1 | SS220-32 |

3/4" Square Drive Stainless Steel Sockets with Metric Hex Profile



**SS224**

| 17 mm | 50 mm | 1 | SS224-17 |
|-------|-------|---|----------|
| 19 mm | 50 mm | 1 | SS224-19 |
| 22 mm | 55 mm | 1 | SS224-22 |
| 24 mm | 55 mm | 1 | SS224-24 |
| 27 mm | 55 mm | 1 | SS224-27 |
| 30 mm | 60 mm | 1 | SS224-30 |
| 32 mm | 60 mm | 1 | SS224-32 |
| 34 mm | 60 mm | 1 | SS224-34 |
| 36 mm | 60 mm | 1 | SS224-36 |
| 41 mm | 65 mm | 1 | SS224-41 |
| 46 mm | 65 mm | 1 | SS224-46 |
| 50 mm | 70 mm | 1 | SS224-50 |
| 55 mm | 75 mm | 1 | SS224-55 |
| 60 mm | 75 mm | 1 | SS224-60 |
| 65 mm | 80 mm | 1 | SS224-65 |

Stainless Steel Extensions



**SS234**

| 100 mm | 1/2" | 1 | SS234-16-100 |
|--------|------|---|--------------|
| 200 mm | 1/2" | 1 | SS234-16-200 |
| 250 mm | 1/2" | 1 | SS234-16-250 |

| 100 mm | 3/4" | 1 | SS234-24-100 |
|--------|------|---|--------------|
| 200 mm | 3/4" | 1 | SS234-24-200 |
| 250 mm | 3/4" | 1 | SS234-24-250 |

Stainless Steel Universal Joints



**SS236**

| 56 mm  | 1/4" | 1 | SS236-08-80  |
|--------|------|---|--------------|
| 80 mm  | 1/2" | 1 | SS236-16-80  |
| 110 mm | 3/4" | 1 | SS236-24-110 |

Stainless Steel Sliding T-Handles



**SS238**

| 250 mm | 1/4" | 1 | SS238-08-250 |
|--------|------|---|--------------|
| 250 mm | 1/2" | 1 | SS238-16-250 |
| 350 mm | 3/4" | 1 | SS238-24-350 |

Stainless Steel Rotary Speed Handles



**SS243**

| 300 mm | 1/4" | 1 | SS243-08 |
|--------|------|---|----------|
| 390 mm | 1/2" | 1 | SS243-16 |
| 450 mm | 3/4" | 1 | SS243-24 |



Stainless Steel Reversible Ratchets



SS242

| Length | Hex Size | Qty | Part No.     |
|--------|----------|-----|--------------|
| 200 mm | 1/4"     | 1   | SS242-08-200 |
| 245 mm | 1/2"     | 1   | SS242-16-245 |
| 320 mm | 3/4"     | 1   | SS242-24-320 |

SCREWDRIVERS

ERGO™ Stainless Steel Straight Tipped Slotted Screwdrivers with 3-Component Handle 0.5 mm-1.2 mm



BE-8020i - BE-8252i

| Hex Size | Length | Qty | Part No. |
|----------|--------|-----|----------|
| 3.0 mm   | 60 mm  | 5   | BE-8020i |
| 3.5 mm   | 75 mm  | 5   | BE-8030i |
| 4.0 mm   | 100 mm | 5   | BE-8040i |
| 5.5 mm   | 125 mm | 5   | BE-8241i |
| 6.5 mm   | 150 mm | 5   | BE-8252i |

ERGO™ Stainless Steel Phillips Screwdrivers with 3-Component Handle PH0-PH4



BE-8600i - BE-8623i

| Hex Size | Length | Qty | Part No. |
|----------|--------|-----|----------|
| PH 0     | 60 mm  | 5   | BE-8600i |
| PH 1     | 75 mm  | 5   | BE-8610i |
| PH 2     | 100 mm | 5   | BE-8620i |
| PH 3     | 150 mm | 5   | BE-8623i |

ERGO™ Stainless Steel Pozidriv Screwdrivers with 3-Component Handle PZ0-PZ4



BE-8800i - BE-8823i

| Hex Size | Length | Qty | Part No. |
|----------|--------|-----|----------|
| PZ 0     | 60 mm  | 5   | BE-8800i |
| PZ 1     | 75 mm  | 5   | BE-8810i |
| PZ 2     | 100 mm | 5   | BE-8820i |
| PZ 3     | 150 mm | 5   | BE-8823i |

ERGO™ Stainless Steel TORX® Screwdrivers with 3-Component Handle T10-T25



BE-8910i - BE-8925i

| Hex Size | Length | Qty | Part No. |
|----------|--------|-----|----------|
| T 10     | 75 mm  | 5   | BE-8910i |
| T 15     | 100 mm | 5   | BE-8915i |
| T 20     | 100 mm | 5   | BE-8920i |
| T 25     | 125 mm | 5   | BE-8925i |

ERGO™ Stainless Steel Slotted/Phillips Screwdriver Set - 6 Pcs



BE-9881i

| Hex Size | Qty | Part No. |
|----------|-----|----------|
| 6        | 1   | BE-9881i |

BE-8020i, BE-8040i, BE-8241i, BE-8252i

BE-8610i, BE-8620i

ERGO™ Stainless Steel Slotted/Pozidriv Screwdriver Set - 6 Pcs



BE-9882i

| Hex Size | Qty | Part No. |
|----------|-----|----------|
| 6        | 1   | BE-9882i |

BE-8020i, BE-8040i, BE-8241i, BE-8252i

BE-8810i, BE-8820i

L-KEYS

Metric Stainless Steel L-Keys with Long Ball End for Hex Screws



SS324

| Hex Size | Length | Qty | Part No.  |
|----------|--------|-----|-----------|
| 1.5 mm   | 80 mm  | 2   | SS324-1.5 |
| 2 mm     | 85 mm  | 2   | SS324-2   |
| 2.5 mm   | 93 mm  | 2   | SS324-2.5 |
| 3 mm     | 103 mm | 1   | SS324-3   |
| 4 mm     | 110 mm | 1   | SS324-4   |
| 5 mm     | 123 mm | 1   | SS324-5   |
| 6 mm     | 146 mm | 1   | SS324-6   |
| 8 mm     | 168 mm | 1   | SS324-8   |
| 10 mm    | 180 mm | 1   | SS324-10  |

Metric Stainless Steel L-Key Set with Long Ball End for Hex Screws - 9 Pcs



BE-9770i

| Hex Size | Qty | Part No. |
|----------|-----|----------|
| 9        | 20  | BE-9770i |



SS324-1.5, SS324-2, SS324-2.5,  
SS324-3, SS324-4, SS324-5, SS324-6,  
SS324-8, SS324-10

Imperial Stainless Steel L-Keys with Long  
Ball End for Hex Screws



**SS325**



| Size     | Length (L) | Quantity | Part Number |
|----------|------------|----------|-------------|
| 5/64" in | 85 mm      | 2        | SS325-2.5   |
| 7/64" in | 96 mm      | 2        | SS325-3.5   |
| 1/8" in  | 101 mm     | 1        | SS325-4     |
| 9/64" in | 106 mm     | 1        | SS325-4.5   |
| 5/32" in | 111 mm     | 1        | SS325-5     |
| 3/16" in | 121 mm     | 1        | SS325-6     |
| 7/32" in | 132 mm     | 1        | SS325-7     |
| 1/4" in  | 142 mm     | 1        | SS325-8     |
| 5/16" in | 163 mm     | 1        | SS325-10    |
| 3/8" in  | 183 mm     | 1        | SS325-12    |
| 3/32" in | 90 mm      | 2        | SS325-3     |

Imperial Stainless Steel L-Key Set with  
Long Ball End for Hex Screws - 13 Pcs



**BE-9786i**

| Quantity | Sizes   | Part Number |
|----------|---|-------------|
| 13       | 0.05; 1/16; 5/64; 3/32;<br>7/64; 1/8; 9/64; 5/32; 3/16;<br>7/32; 1/4; 5/16; 3/8; in | 1 BE-9786i  |

SS325-2.5, SS325-3, SS325-3.5,  
SS325-4, SS325-4.5, SS325-5, SS325-  
6, SS325-7, SS325-8, SS325-10,  
SS325-12

**SCREWDRIVER BITS**

1/4" Stainless Steel Torsion Screwdriver  
Bits for Phillips Head Screws 25 mm



**65I/PH**

| Quantity | Size | Part Number  |
|----------|------|--------------|
| 10       | 1    | 1 65I/PH1    |
| 2        | 1    | 1 65I/PH1-2P |
| 10       | 2    | 1 65I/PH2    |
| 2        | 2    | 1 65I/PH2-2P |
| 10       | 3    | 1 65I/PH3    |
| 2        | 3    | 1 65I/PH3-2P |

1/4" Stainless Steel Torsion Screwdriver  
Bits for Pozidriv Head Screws 25 mm



**65I/PZ**

| Quantity | Size | Part Number  |
|----------|------|--------------|
| 10       | 1    | 1 65I/PZ1    |
| 2        | 1    | 1 65I/PZ1-2P |
| 10       | 2    | 1 65I/PZ2    |
| 2        | 2    | 1 65I/PZ2-2P |
| 10       | 3    | 1 65I/PZ3    |
| 2        | 3    | 1 65I/PZ3-2P |

1/4" Stainless Steel Torsion Screwdriver  
Bits for TORX® Head Screws 25 mm



**65I/T**

| Quantity | Size | Part Number  |
|----------|------|--------------|
| 5        | T15  | 1 65I/T15    |
| 5        | T25  | 1 65I/T25    |
| 5        | T30  | 1 65I/T30    |
| 5        | T40  | 1 65I/T40    |
| 2        | T40  | 1 65I/T40-2P |

1/4" Hex Universal Bit Holders with  
Retaining Ring 75 mm



**KSR753**

| Quantity | Size   | Part Number |
|----------|--------|-------------|
| 1        | 1/4 in | 1 KSR753-1P |
| 5        | 1/4 in | 1 KSR753    |

1/4" Stainless Steel Bit Set for Phillips/  
Pozidriv/TORX® Screws - 7 Pcs



**65I/7**

| Dimensions      | Part Number |
|-----------------|-------------|
| 22 x 65 x 75 mm | 1 65I/7-1   |

|   |  |
|---|--|
| <b>65I/PH2</b>                            |  |
| <b>65I/PZ2</b>                            |  |
| <b>65I/T15, 65I/T20, 65I/T25, 65I/T30</b> |  |

**PLIERS**

Stainless Steel Combination Pliers with  
PVC Coated Handles



**SS400**

| Length (L) | Part Number |
|------------|-------------|
| 155 mm     | 1 SS400-160 |
| 175 mm     | 1 SS400-180 |
| 200 mm     | 1 SS400-200 |



Stainless Steel Diagonal Cutting Pliers with PVC Coated Handles



**SS402**



|        |   |           |
|--------|---|-----------|
| 150 mm | 1 | SS402-160 |
| 195 mm | 1 | SS402-200 |

Stainless Steel Slip Joint Pliers with 2-Position and PVC Coated Handles



**SS412**



|        |   |           |
|--------|---|-----------|
| 200 mm | 1 | SS412-200 |
|--------|---|-----------|

Stainless Steel Snipe Nose Pliers with PVC Coated Handles



**SS406**



|        |   |           |
|--------|---|-----------|
| 150 mm | 1 | SS406-160 |
| 175 mm | 1 | SS406-200 |

Stainless Steel Box Joint Pliers with PVC Coated Handles



**SS410**



|        |   |           |
|--------|---|-----------|
| 250 mm | 1 | SS410-250 |
| 300 mm | 1 | SS410-300 |

Stainless Steel Locking Pliers



**SS415**



|        |   |           |
|--------|---|-----------|
| 255 mm | 1 | SS415-225 |
|--------|---|-----------|

**HAMMERS**

Stainless Steel Ball Pein Hammers with Fibreglass Handle



**SS506**



|        |   |               |
|--------|---|---------------|
| 200 g  | 1 | SS506-200-FB  |
| 300 g  | 1 | SS506-300-FB  |
| 450 g  | 1 | SS506-500-FB  |
| 680 g  | 1 | SS506-700-FB  |
| 900 g  | 1 | SS506-900-FB  |
| 1100 g | 1 | SS506-1100-FB |

Stainless Steel Sledge Hammers with Fibreglass Handle



**SS502**



|        |   |               |
|--------|---|---------------|
| 1000 g | 1 | SS502-1000-FB |
| 1500 g | 1 | SS502-1500-FB |
| 2000 g | 1 | SS502-2000-FB |
| 2500 g | 1 | SS502-2500-FB |
| 3000 g | 1 | SS502-3000-FB |
| 3600 g | 1 | SS502-3600-FB |

**PUNCHES & COLD CHISELS**

Stainless Steel Tapered Pry Bars



**SS603**



|         |   |               |
|---------|---|---------------|
| 500 mm  | 1 | SS603-15-500  |
| 500 mm  | 1 | SS603-19-500  |
| 500 mm  | 1 | SS603-20-500  |
| 500 mm  | 1 | SS603-23-500  |
| 800 mm  | 1 | SS603-23-800  |
| 600 mm  | 1 | SS603-25-600  |
| 1000 mm | 1 | SS603-30-1000 |

Stainless Steel 55° Flat Chisel with Oval Form



**SS610**



|        |   |              |
|--------|---|--------------|
| 160 mm | 1 | SS610-16-160 |
| 200 mm | 1 | SS610-18-200 |
| 300 mm | 1 | SS610-24-300 |
| 400 mm | 1 | SS610-25-400 |
| 500 mm | 1 | SS610-30-500 |

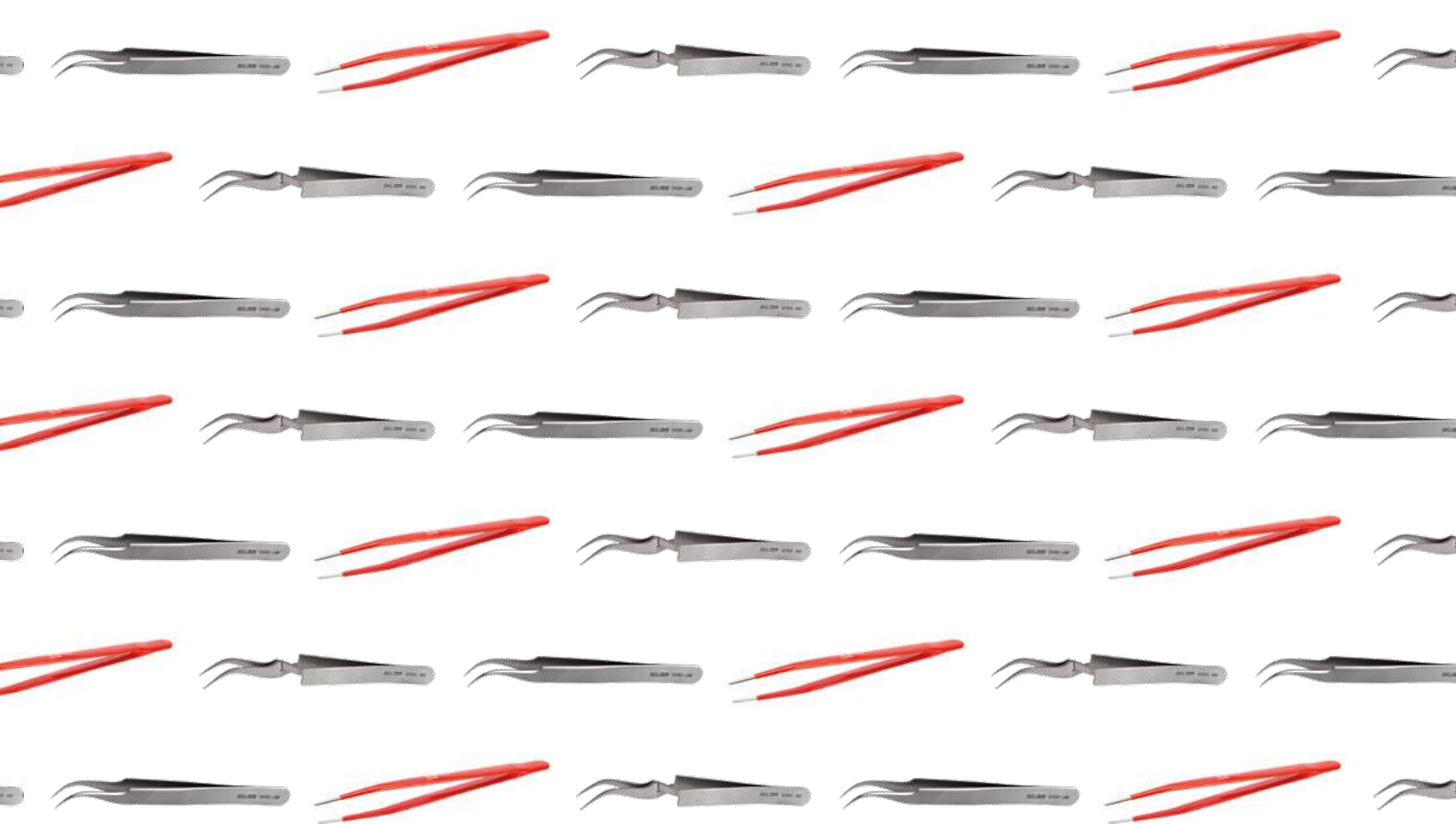

## Tweezers & Electronics Specialty Tools



## TWEEZERS

General Purpose Tweezers with Serrated Tips



**5468**



112 mm



5 5468-112

General Purpose Tweezers with Polished/PVC Coated Finish 127 mm



**5469**



127 mm  
127 mm  
127 mm



5 5469-127  
5 5469 R  
5 5469 I

General Purpose Tweezers with Polished/PVC Coated Finish 120 mm



**5469B**



120 mm  
120 mm



5 5469 B  
5 5469 BI

General Pointed Tweezers with Polished and Nickel Plated Finish



**5479**



130 mm



5 5479-130

General Purpose Tweezers with Polished and Nickel Plated/Polished/PVC Coated Finish



**5471F**



120 mm  
145 mm  
200 mm  
250 mm  
300 mm  
120 mm  
200 mm  
120 mm  
145 mm



5 5471 F-120  
5 5471 F-145  
5 5471 F-200  
5 5471 F-250  
5 5471 F-300  
5 5471 FI-120  
5 5471 FI-200  
5 5471 FR-120  
5 5471 FR-145

General Purpose Tweezers with Polished and Nickel Plated/Polished Finish



**5475R/5475K**



150 mm  
100 mm



5 5475 R  
5 5475 K

General Purpose Tweezers with Polished and Nickel Plated/PVC Coated Finish



**5516**



150 mm  
150 mm



5 5516  
5 5516 I

Non-Magnetic Titanium General Tweezers for Fine and Ultra-Fine Assembly Work 110 mm



**5465AMT**



110 mm



5 5465 AMT

General Pointed Tweezers with Polished and Nickel Plated/PVC Coated Finish



**5517**



155 mm  
155 mm



5 5517  
5 5517 I

General Reverse Action Tweezers with Polished and Nickel Plated Finish



**5518**



155 mm



5 5518

SMD Tweezers for Handling and Positioning SOT Packages



**5540AM**



120 mm



5 5540 AM



SMD Tweezers for Positioning All SOT Packages Vertically



**5541AM**



120 mm



5 5541 AM

SMD Tweezers for Positioning and Soldering 1 mm Components at 45° Angle



**5547AM**



120 mm



5 5547 AM

Electronics Tweezers for Easy Manipulation of Components in Confined Areas



**5490AM**



115 mm



5 5490 AM

SMD Tweezers for Handling and Positioning 2/3 Lead SOT Packages at 45° Angle



**5544AM**



115 mm



5 5544 AM

SMD Tweezers for Positioning 5 mm Monolithic Chip Capacitors



**5549AM**



120 mm



5 5549 AM

Assembly Tweezers for Diagonal Inserting and Desoldering Circuit Board Levels with 6 mm Jaw



**5573**



145 mm



5 5573-145

SMD Tweezers for Positioning Flat Devices at 60° Angle



**5545AM**



120 mm



5 5545 AM

Electronics Tweezers for Holding Smallest Components



**5488AM**



115 mm



5 5488 AM

Assembly Tweezers for Inserting and Desoldering Horizontal Components with 4 mm Jaw



**5578**



122 mm



5 5578-115

SMD Tweezers for Positioning and Soldering 1 mm Components



**5546AM**



120 mm



5 5546 AM

Electronics Tweezers for Picking Up Flat Lying Components



**5489AM**



115 mm



5 5489 AM

Assembly Tweezers for Inserting and Desoldering Horizontal Components



**5579**



115 mm



5 5579-115



SMD Tweezers for Positioning 5 mm Monolithic Chip at 60° Angle



**5588AM**



120 mm 5 5588 AM

SMD Tweezers with Grooved Tips and 30° Bent Angle



**5589AM**



120 mm 5 5589 AM

SMD Tweezers for Vertical Positioning of Cylindrical Devices Ø1 mm or More



**5590AM**



120 mm 5 5590 AM

Stainless Steel SMD Tweezers Set - 5 Pcs



**5568/5**



100 g 1 5568/5

|         |  |
|---------|--|
| 5489 AM |  |
| 5583 AM |  |
| 5589 AM |  |
| 5584 AM |  |
| 5546 AM |  |

Watchmaker's Straight Tweezers with Polished Finish 120 mm



**5463**



120 mm 5 5463-120  
120 mm 5 5463 R

Jeweller's Tweezers with Polished and Nickel Plated/PVC Coated Finish



**5470**



120 mm 5 5470-120

Heat Absorbing Tweezers for Soldering on Semiconductors



**5577**



145 mm 5 5577-145

Watchmaker's Straight Tweezers with Polished Finish 105 mm



**5465**



105 mm 5 5465 R

Cutting Tweezers for Copper Wires



**5493**



115 mm 5 5493-115

Soldering Tweezers with Vulcanised Fibre Hand Protection



**5476H**



160 mm 5 5476 H

## SOLDERING TOOLS

Instant Heat Double Insulated Soldering Guns



**3250**



|       |        |   |           |
|-------|--------|---|-----------|
| 100 W | 400 °C | 1 | 325001000 |
|       |        | 1 | 3250010SH |

3250010SH: Spare tip

Heavy-Duty Soldering Irons with Euro Plug and Soldering Stand 30 W/40 W/80 W



**322500**



|      |        |   |           |
|------|--------|---|-----------|
| 30 W | 370 °C | 1 | 322500300 |
| 40 W | 375 °C | 1 | 322500500 |
| 80 W | 380 °C | 1 | 322500800 |

Electronic Soldering Irons with Euro Plug and Earth Connection 18 W/25 W



**32600**



|      |        |   |           |
|------|--------|---|-----------|
| 18 W | 390 °C | 1 | 326000200 |
| 25 W | 420 °C | 1 | 326000300 |

Temperature Controlled Soldering Irons with Euro Plug and Soldering Stand



**3270**



|      |            |   |           |
|------|------------|---|-----------|
| 50 W | 200-500 °C | 1 | 327020500 |
|------|------------|---|-----------|

Spare Tips for Heavy-Duty Soldering Iron with Straight and Angled Version



**3225**



|              |   |           |
|--------------|---|-----------|
| 1.5 x 2.5 mm | 1 | 322510300 |
| 1.5 x 2.5 mm | 1 | 322510400 |
| 2 x 3 mm     | 1 | 322510500 |
| 2 x 3 mm     | 1 | 322510600 |
| 2.5 x 5 mm   | 1 | 322510700 |
| 2.5 x 5 mm   | 1 | 322510800 |

Spare Tips for Electronic Soldering Guns



**326010**



|     |   |           |
|-----|---|-----------|
| 5 g | 1 | 326010200 |
| 5 g | 1 | 326020200 |
| 5 g | 1 | 326030200 |

Spare Tips for 3270 Temperature Controlled Soldering Irons



**327020500-SH**



|       |   |               |
|-------|---|---------------|
| 0,5mm | 1 | 327020500-SH1 |
| 2mm   | 1 | 327020500-SH2 |
| 3mm   | 1 | 327020500-SH3 |
| 4mm   | 1 | 327020500-SH4 |

Lead-Free Solders 0.8 mm



**3290**



|         |   |           |
|---------|---|-----------|
| 2000 mm | 1 | 329000330 |
| 4000 mm | 1 | 329000500 |

## FINE MECHANICAL

Miniature Awls/Hooks/Picks Tool Set 150 mm-250 mm



**2633/**



|                  |    |          |
|------------------|----|----------|
| 17 x 80 x 150 mm | 12 | 2633/S4  |
| 12 x 12 x 275 mm | 12 | 2633L/S4 |



Double End Wires and Spring Hooks with Knurled Hexagon Handle



**5418**



145 mm



1 5418

Adjusting Screwdrivers with Guide Sleeve and Plastic Handle



**5550**



140 mm  
140 mm



10 5550-3.2  
10 5550-4.5

Lacquer Stripping Tweezers with Plastic Grips



**2530-32/2530-40**



130 mm



5 2530-40

Hook Set 105 mm - 6 Pcs



**5419/6T**



5 x 78 x 110 mm



1 5419/6T

Tuning and Trimming Tools



**5551-5554**



220 mm  
205 mm  
195 mm  
180 mm



1 5551  
1 5552  
1 5553  
1 5554

Carbon Scrapers with Plastic Handle



**2487**



210 mm



12 2487

3-Square Scrapers with Nickel Plated Handle



**3524**



24 g  
5 g



1 3524  
1 3524L-K

ERGO™ O-Ring Levers for Desoldering



**BE-3529**



197 mm



5 BE-3529

Tuning and Trimming Tools Set



**5600/4**



75 g



1 5600/4

3-Square Machinist's Scrapers with Plastic Handle



**3525HB**



168 mm



5 3525HB

5551, 5552, 5553, 5554





# Measuring & Layout



## MEASURING TAPES

Double-Sided Measuring Tapes with Rubber Grip



### MTS

| Length | Blade Width | Quantity | Model      |
|--------|-------------|----------|------------|
| 5 m    | 25 mm       | 6        | MTS-5-25   |
| 5 m    | 25 mm       | 6        | MTS-5-25-E |
| 8 m    | 25 mm       | 6        | MTS-8-25   |
| 8 m    | 25 mm       | 6        | MTS-8-25-E |

Short Measuring Tapes with Positive Locking Button



### MTG

| Length | Blade Width | Quantity | Model      |
|--------|-------------|----------|------------|
| 3 m    | 16 mm       | 12       | MTG-3-16   |
| 3 m    | 16 mm       | 12       | MTG-3-16-E |
| 5 m    | 19 mm       | 12       | MTG-5-19   |
| 5 m    | 19 mm       | 12       | MTG-5-19-E |
| 8 m    | 25 mm       | 4        | MTG-8-25   |
| 8 m    | 25 mm       | 4        | MTG-8-25-E |

COMPACT 3 M x 13 mm METRIC MEASURING TAPE



### MT-TS-3

| Length | Blade Width | Quantity | Model   |
|--------|-------------|----------|---------|
| 3 m    | 13 mm       | 12       | MT-TS-3 |

Short Measuring Tapes with Rubber Grip



### MTB

| Length | Blade Width | Quantity | Model        |
|--------|-------------|----------|--------------|
| 3 m    | 16 mm       | 6        | MTB-3-16     |
| 3 m    | 16 mm       | 6        | MTB-3-16-M   |
| 3 m    | 16 mm       | 6        | MTB-3-16-M-E |
| 5 m    | 25 mm       | 6        | MTB-5-25     |
| 5 m    | 25 mm       | 6        | MTB-5-25-M   |
| 5 m    | 25 mm       | 6        | MTB-5-25-M-E |
| 8 m    | 25 mm       | 6        | MTB-8-25     |
| 8 m    | 25 mm       | 6        | MTB-8-25-M   |
| 8 m    | 25 mm       | 6        | MTB-8-25-M-E |

Short Measuring Tapes with ABS Grip Compact Class-I



### MTC\_C1

| Length | Blade Width | Quantity | Model       |
|--------|-------------|----------|-------------|
| 3 m    | 13 mm       | 6        | MTC-3-13-C1 |
| 5 m    | 16 mm       | 6        | MTC-5-16-C1 |

Short Measuring Tapes with Steel Blade



### 1162N

| Length | Blade Width | Quantity | Model     |
|--------|-------------|----------|-----------|
| 3 m    | 13 mm       | 1        | 1162N-1/2 |

Short Measuring Tapes with Rubber Grip Class-I



### MTB\_C1

| Length | Blade Width | Quantity | Model       |
|--------|-------------|----------|-------------|
| 5 m    | 25 mm       | 6        | MTB-5-25-C1 |

Short Measuring Tapes with ABS Grip Compact Class-II



### MTC\_C2

| Length | Blade Width | Quantity | Model    |
|--------|-------------|----------|----------|
| 3 m    | 13 mm       | 6        | MTC-3-13 |
| 5 m    | 16 mm       | 6        | MTC-5-16 |

Adhesive Steel Bench Measuring Tapes



### BT

| Length | Blade Width | Quantity | Model    |
|--------|-------------|----------|----------|
| 3 m    | 13 mm       | 12       | BTR-3-13 |
| 6 m    | 13 mm       | 12       | BTR-6-13 |
| 3 m    | 13 mm       | 12       | BTL-3-13 |
| 6 m    | 13 mm       | 12       | BTL-6-13 |

Long Measuring Tapes with Steel Blade



**LTG**

| L    | Blade Width | Quantity | Model  |
|------|-------------|----------|--------|
| 10 m | 10 mm       | 6        | LTG-10 |
| 20 m | 10 mm       | 6        | LTG-20 |
| 30 m | 10 mm       | 6        | LTG-30 |

Long Measuring Tapes with Nylon Coated Blade



**LTB**

| L    | Blade Width | Quantity | Model  |
|------|-------------|----------|--------|
| 10 m | 13 mm       | 6        | LTB-10 |
| 20 m | 13 mm       | 6        | LTB-20 |
| 30 m | 13 mm       | 6        | LTB-30 |

Long Measuring Tapes with Steel Blade and Open Case



**LT-STEEL**

| L    | Blade Width | Quantity | Model       |
|------|-------------|----------|-------------|
| 30 m | 13 mm       | 5        | LT-STEEL-30 |
| 50 m | 13 mm       | 5        | LT-STEEL-50 |

Long Measuring Tapes with Nylon Coated Blade and Open Case



**LTS**

| L     | Blade Width | Quantity | Model     |
|-------|-------------|----------|-----------|
| 30 m  | 13 mm       | 5        | LTS-30    |
| 30 m  | 13 mm       | 5        | LTS-30-E  |
| 50 m  | 13 mm       | 5        | LTS-50    |
| 50 m  | 13 mm       | 5        | LTS-50-E  |
| 100 m | 13 mm       | 5        | LTS-100   |
| 100 m | 13 mm       | 5        | LTS-100-E |

**MEASURING WHEELS**

Metric Rubber Coated Measuring Wheels 150 mm



**MW-150**

| L      | Quantity | Model  |
|--------|----------|--------|
| 150 mm | 2        | MW-150 |

Metric Rubber Coated Measuring Wheels 250 mm



**MW-250**

| L      | Quantity | Model  |
|--------|----------|--------|
| 250 mm | 2        | MW-250 |

**SPIRIT LEVELS**

Thick Shaped Aluminium Profile Spirit Levels



**466**

| L       | Quantity | Model      |
|---------|----------|------------|
| 400 mm  | 4        | 466-400    |
| 400 mm  | 4        | 466-400-M  |
| 600 mm  | 4        | 466-600    |
| 600 mm  | 4        | 466-600-M  |
| 800 mm  | 4        | 466-800    |
| 800 mm  | 4        | 466-800-M  |
| 1000 mm | 4        | 466-1000   |
| 1000 mm | 4        | 466-1000-M |
| 1200 mm | 4        | 466-1200   |
| 1200 mm | 4        | 466-1200-M |
| 1800 mm | 4        | 466-1800   |
| 2000 mm | 4        | 466-2000   |

Rectangular Aluminium Profile Spirit Levels



**426**

| L       | Blade Width | Quantity | Model    |
|---------|-------------|----------|----------|
| 400 mm  | 49x22 mm    | 1        | 426-400  |
| 600 mm  | 49x22 mm    | 1        | 426-600  |
| 800 mm  | 49x22 mm    | 1        | 426-800  |
| 1000 mm | 49x22 mm    | 1        | 426-1000 |
| 1200 mm | 49x22 mm    | 1        | 426-1200 |

400 mm and 600 mm with 2 vials. 600 mm to 1200 mm with 3 vials



### Light Aluminium Spirit Levels



#### 416

| Length  | Quantity | Part Number |
|---------|----------|-------------|
| 400 mm  | 10       | 416-400     |
| 600 mm  | 10       | 416-600     |
| 800 mm  | 10       | 416-800     |
| 1000 mm | 10       | 416-1000    |
| 1200 mm | 10       | 416-1200    |
| 1500 mm | 10       | 416-1500    |
| 1800 mm | 10       | 416-1800    |
| 2000 mm | 10       | 416-2000    |

### Level made from solid injected aluminium



#### 405

| Length  | Quantity | Part Number |
|---------|----------|-------------|
| 400 mm  | 5        | 405-400     |
| 600 mm  | 5        | 405-600     |
| 800 mm  | 10       | 405-800     |
| 1000 mm | 5        | 405-1000    |

### Magnetic Level, Solid Injected Aluminium



#### 405\_M

| Length  | Quantity | Part Number |
|---------|----------|-------------|
| 400 mm  | 5        | 405-400-M   |
| 600 mm  | 5        | 405-600-M   |
| 800 mm  | 5        | 405-800-M   |
| 1000 mm | 5        | 405-1000-M  |

### Lightweight Level made from solid injected aluminium



#### 405L

| Length | Quantity | Part Number |
|--------|----------|-------------|
| 400 mm | 10       | 405L-400    |
| 600 mm | 10       | 405L-600    |

### Lightweight Magnetic Level made from solid injected aluminium



#### 405L\_M

| Length | Quantity | Part Number |
|--------|----------|-------------|
| 400 mm | 5        | 405L-400-M  |
| 600 mm | 5        | 405L-600-M  |

### Solid Injected Aluminium Spirit Levels



#### 406

| Length | Quantity | Part Number |
|--------|----------|-------------|
| 300 mm | 1        | 406-300     |
| 400 mm | 5        | 406-400     |
| 500 mm | 5        | 406-500     |
| 600 mm | 5        | 406-600     |
| 800 mm | 5        | 406-800     |

### Solid Injected Aluminium Magnetic Spirit Levels



#### 406\_M

| Length | Quantity | Part Number |
|--------|----------|-------------|
| 300 mm | 1        | 406-300-M   |
| 400 mm | 1        | 406-400-M   |
| 500 mm | 1        | 406-500-M   |
| 600 mm | 1        | 406-600-M   |

### Polystyrene Spirit Levels



#### 406P

| Length | Quantity | Part Number |
|--------|----------|-------------|
| 400 mm | 10       | 406P-400    |
| 600 mm | 10       | 406P-600    |

### Spirit Level Set 600/1200/1800 mm - 3 Pcs/Carry Bag



#### 416-SET+BAG

| Quantity | Part Number |
|----------|-------------|
| 3        | 416-SET+BAG |

416-SET-1

4750-LV-1

BAHCO



Spirit Level Set 600/1200/1800 mm - 3 Pcs



**416-SET-1**



3 5 416-SET-1

416-600, 416-1200, 416-1800



Spirit Level Set 600/1200/2000 mm - 3 Pcs



**416-SET-2**



3 5 416-SET-2

416-600, 416-1200, 416-2000



Magnetic Plastic Spirit Torpedo Levels



**406T-225**



228 mm 10 406T-225

DISP is a counter display with 12 units

Aluminium Spirit Torpedo Levels



**426TOR9**



230 mm 10 426TOR9

Aluminium Spirit Scaffold Levels



**466-250**



250 mm 10 466-250

Aluminium Spirit Line Levels 75 mm



**466-LINE**



75 mm 12 466-LINE

Flat Surface 2-Way Spirit Levels



**466-BE1**



20 g 12 466-BE1

Magnetic Spirit Levels for Fence Post



**466-POST**



120 x 75 x 80 mm 6 466-POST

Aluminium Straight Edge Spirit Levels



**486**



1800 mm 5 486-1800  
2000 mm 5 486-2000  
2400 mm 5 486-2400

Aluminium Straight Edge Spirit Levels Unhandled



**486-xxxWH**



1800 mm 5 486-1800WH  
2000 mm 5 486-2000WH  
2400 mm 5 486-2400WH

Double T-Profile Spirit Precision Levels



**496**



1500 mm 5 496-1500  
1800 mm 5 496-1800





Spare Vial for 496 Levels



**496-SPARE**

|                    |   |           |
|--------------------|---|-----------|
|                    |   |           |
| 496-1500, 496-1800 | 1 | 496-SPARE |

**MARKING**

Chalk Lines 5x Rewind



**CL-1441**

|        |    |         |
|--------|----|---------|
|        |    |         |
| 185 mm | 36 | CL-1441 |

Chalk Lines 1x Rewind



**CL-1331**

|        |    |         |
|--------|----|---------|
|        |    |         |
| 185 mm | 48 | CL-1331 |

Chalk Lines 3x Rewind



**CL-1221**

|        |   |         |
|--------|---|---------|
|        |   |         |
| 130 mm | 6 | CL-1221 |

Marking Chalk 227 g/Pour Bottle



**CHALK**

|       |   |              |
|-------|---|--------------|
|       |   |              |
| 227 g | 6 | CHALK-BLUE   |
| 227 g | 6 | CHALK-WHITE  |
| 227 g | 6 | CHALK-RED    |
| 227 g | 6 | CHALK-YELLOW |

Chalk Line Set 3x Rewind - 3 Pcs



**CL-1221-SET**

|       |   |             |
|-------|---|-------------|
|       |   |             |
| 180 g | 4 | CL-1221-SET |

**CHALK-BLUE**

466-LINE

CL-1221

Plumb Bobs with 5 m Cord



**PBS**

|     |   |         |
|-----|---|---------|
|     |   |         |
| 5 m | 6 | PBS-700 |

Plumb Bobs with Hardened Steel Tip



**PBB**

|        |       |   |       |
|--------|-------|---|-------|
|        |       |   |       |
| 185 mm | 227 g | 8 | PBB-8 |

HB Grade Pencils - 25 Pcs/Box



**P-HB**

|        |    |    |      |
|--------|----|----|------|
|        |    |    |      |
| 175 mm | 25 | 25 | P-HB |

FSC Certificate Code: QMI-COC-001417 File No.: 1627439

HB Grade Pencils - 200 Pcs/Display



**PENCIL-200**

|        |     |                   |
|--------|-----|-------------------|
|        |     |                   |
| 180 mm | 200 | 1 PENCIL-200-DISP |

HB Grade Pencils



**P-MEC**

|        |   |               |
|--------|---|---------------|
|        |   |               |
| 150 mm | 1 | 24 P-MEC      |
| 100 mm | 5 | 12 P-MEC-LEAD |

Scribers with Interchangeable Carbide Point



**1179-SCRIBE**

|        |   |             |
|--------|---|-------------|
|        |   |             |
| 150 mm | 5 | 1179-SCRIBE |
|        | 1 | 1179-TIPS   |

Tungsten Carbide Scribers



**1178-SCRIBE**

|        |   |             |
|--------|---|-------------|
|        |   |             |
| 150 mm | 5 | 1178-SCRIBE |

High Performance Alloy Steel Offset Scribers



**1177-SCRIBE**

|        |   |             |
|--------|---|-------------|
|        |   |             |
| 230 mm | 5 | 1177-SCRIBE |

**RULES**

5-Section Wooden Folding Rules 1 m



**WR1**

|     |       |           |
|-----|-------|-----------|
|     |       |           |
| 1 m | 17 mm | 50 WR1    |
| 1 m | 17 mm | 50 WR1-MM |

10-Section Wooden Folding Rules 2 m



**WR2**

|     |       |           |
|-----|-------|-----------|
|     |       |           |
| 2 m | 17 mm | 25 WR2    |
| 2 m | 17 mm | 25 WR2-MM |

Wooden Folding Rules with 12 Section 2 m



**WR2-12**

|     |       |           |
|-----|-------|-----------|
|     |       |           |
| 2 m | 17 mm | 25 WR2-12 |

Metric and Imperial Flexible Stainless Steel Rulers



**1179-FLX**

|        |       |             |
|--------|-------|-------------|
|        |       |             |
| 160 mm | 12 mm | 25 1179-FLX |

Metric Stainless Steel Rulers



**SR MM**

|         |       |              |
|---------|-------|--------------|
|         |       |              |
| 150 mm  | 19 mm | 12 SR150-MM  |
| 200 mm  | 19 mm | 12 SR200-MM  |
| 300 mm  | 25 mm | 12 SR300-MM  |
| 600 mm  | 30 mm | 20 SR600-MM  |
| 1000 mm | 35 mm | 20 SR1000-MM |



### Imperial Stainless Steel Rulers



#### SR IN

| Length | Blade Width | Quantity | Model    |
|--------|-------------|----------|----------|
| 6 in   | 6 in        | 12       | SR150-E  |
| 8 in   | 8 in        | 12       | SR200-E  |
| 12 in  | 12 in       | 12       | SR300-E  |
| 24 in  | 24 in       | 20       | SR600-E  |
| 39 in  | 40 in       | 20       | SR1000-E |

### Construction Squares for Layout and Setting Up

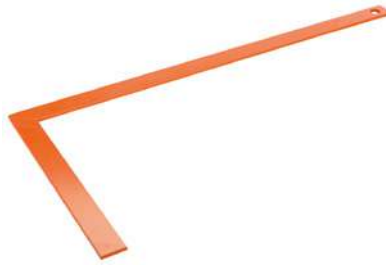

#### 3085

| Length  | Blade Width | Quantity | Model     |
|---------|-------------|----------|-----------|
| 400 mm  | 200 mm      | 1        | 308504000 |
| 500 mm  | 250 mm      | 1        | 308505000 |
| 600 mm  | 300 mm      | 1        | 308506000 |
| 800 mm  | 400 mm      | 1        | 308508000 |
| 1000 mm | 500 mm      | 1        | 308510000 |

### Sliding Bevel Squares with Cold-Rolled Steel Blade



#### 9572

| Length | Blade Width | Quantity | Model    |
|--------|-------------|----------|----------|
| 235 mm | 115 mm      | 20       | 9572-200 |
| 250 mm | 150 mm      | 20       | 9572-250 |

## SQUARES

### Carpenter Squares with Steel Blade



#### 9045-B

| Length | Blade Width | Quantity | Model      |
|--------|-------------|----------|------------|
| 220 mm | 170 mm      | 6        | 9045-B-200 |
| 250 mm | 170 mm      | 6        | 9045-B-250 |
| 300 mm | 170 mm      | 6        | 9045-B-300 |
| 400 mm | 170 mm      | 1        | 9045-B-400 |

### Sliding Combination Squares with Metal Scriber



#### CS

| Length | Blade Width | Quantity | Model |
|--------|-------------|----------|-------|
| 152 mm | 90 mm       | 12       | CS150 |
| 305 mm | 125 mm      | 12       | CS300 |
| 407 mm | 125 mm      | 12       | CS400 |

Spare parts, 4 pcs set.

### Spare parts Kit for CS Model Sliding Squares - 4 Pcs



#### CS-SPARE

| Quantity | Model    |
|----------|----------|
| 1        | CS-SPARE |

### Bevel Squares with Steel Blade



#### 9574

| Length | Blade Width | Quantity | Model    |
|--------|-------------|----------|----------|
| 215 mm | 165 mm      | 10       | 9574-200 |
| 285 mm | 170 mm      | 10       | 9574-250 |
| 300 mm | 170 mm      | 10       | 9574-300 |

### Carpenter Squares with Stainless Steel Blade and Sliding Marker



#### 9048

| Length | Blade Width | Quantity | Model    |
|--------|-------------|----------|----------|
| 200 mm | 165 mm      | 10       | 9048-200 |
| 250 mm | 165 mm      | 10       | 9048-250 |
| 300 mm | 180 mm      | 10       | 9048-300 |
| 350 mm | 180 mm      | 10       | 9048-350 |
| 400 mm | 180 mm      | 10       | 9048-400 |

### Fixed Bevel Squares with Stainless Steel Blade



#### 9575

| Length | Blade Width | Quantity | Model    |
|--------|-------------|----------|----------|
| 250 mm | 110 mm      | 6        | 9575-250 |

Flat Carpenter Squares with Steel Blade



**FCS-600/FCS-1000**

|         |        |   |          |
|---------|--------|---|----------|
|         |        |   |          |
| 600 mm  | 300 mm | 6 | FCS-600  |
| 800 mm  | 300 mm | 6 | FCS-800  |
| 1000 mm | 360 mm | 6 | FCS-1000 |

Mechanical Callipers



**1150**

|        |                 |   |             |
|--------|-----------------|---|-------------|
|        |                 |   |             |
| 150 mm | 9 x 75 x 235 mm | 1 | 1150-1/2H/P |

Professional Feeler Gauges with 20 Blades



**1547**

|    |        |    |      |
|----|--------|----|------|
|    |        |    |      |
| 20 | 100 mm | 20 | 1547 |

0,05 mm steps Carbon steel

Adjustable Precision Squares



**AS-1200**

|         |        |   |         |
|---------|--------|---|---------|
|         |        |   |         |
| 1265 mm | 560 mm | 3 | AS-1200 |

Professional Feeler Gauges with 26 Blades

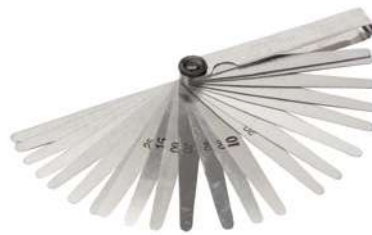

**1544**

|    |        |   |      |
|----|--------|---|------|
|    |        |   |      |
| 26 | 100 mm | 1 | 1544 |

0,03 mm to 0,1 mm in 0,01 mm increments / 0,10 mm to 1,0 mm in 0,05 mm increments

Screw Pitch Gauges with Metric 60°



**1535**

|    |       |   |      |
|----|-------|---|------|
|    |       |   |      |
| 24 | 67 mm | 1 | 1535 |

Stainless steel

**PRECISION MEASURING**

Precision Measuring Digital Callipers with LCD Screen



**1150D**

|        |                  |   |       |
|--------|------------------|---|-------|
|        |                  |   |       |
| 150 mm | 25 x 90 x 245 mm | 1 | 1150D |

Professional Feeler Gauges with 13 Blades



**1546**

|        |  |   |      |
|--------|--|---|------|
|        |  |   |      |
| 100 mm |  | 1 | 1546 |

(0,05-0,30) x 0,05mm (0,30-1,00) x 0,10 mm Carbon steel

Screw Pitch Gauges with Metric 60° and Whitworth 55°



**1537**

|                 |       |   |      |
|-----------------|-------|---|------|
|                 |       |   |      |
| 0.25-6.0 / 4-62 | 70 mm | 1 | 1537 |

0,25-6,00 mm, 4 to 62 TPI Stainless steel





**BAHCO**





## Wall Tools



## SCRAPERS

ERGO™ Precision Paint Scrapers with Dual-Component Handle



ergo



**625**



25 mm



5 625

Replacement Blades for 625 ERGO™ Scrapers



**449**



25 mm



10 449

Replacement Blades for 625 ERGO™ Scrapers



**625-**



3 g

3 g

3 g



10 625-DROP

10 625-PEAR

10 625-ROUND

ERGO™ Universal Paint Scrapers with Dual-Component Handle



ergo



**650**



50 mm



5 650

Replacement Blades for 650 ERGO™ Scrapers



**442**



50 mm

50 mm



10 442-3P

10 442

Replacement Blades for 650 and 665 ERGO™ Scrapers



**850 / 865**



50 mm

65 mm



10 850-1

10 865-1

ERGO™ Heavy Duty Paint Scrapers with Dual-Component Handle



ergo



**665**



65 mm



5 665

Replacement Blades for 665 ERGO™ Scrapers



**451**



65 mm



10 451

ERGO™ Paint Scrapers Set with Dual-Component Handle



ergo



**SCRAPER-SET2**



50 x 145 x 265 mm



1 SCRAPER-SET2

625

625-DROP, 625-PEAR, 625-ROUND

650



Cabinet Scrapers with Plastic Edge Protector



**474**

| Blade Width | Blade Length | Blade Thickness | Quantity | Product Code |
|-------------|--------------|-----------------|----------|--------------|
| 130 mm      | 10           | 474-125-0.60    | 10       | 474-125-0.60 |
| 130 mm      | 10           | 474-125-0.80    | 10       | 474-125-0.80 |
| 150 mm      | 10           | 474-150-0.60    | 10       | 474-150-0.60 |
| 150 mm      | 10           | 474-150-0.80    | 10       | 474-150-0.80 |

Paint Scrapers with Carbon Steel Blade and Wooden Handle



**2155**

| Blade Width | Blade Length | Blade Thickness | Quantity  | Product Code |
|-------------|--------------|-----------------|-----------|--------------|
| 30 mm       | 195 mm       | 12              | 215500300 |              |
| 40 mm       | 195 mm       | 12              | 215500400 |              |
| 50 mm       | 195 mm       | 12              | 215500500 |              |
| 60 mm       | 215 mm       | 12              | 215500600 |              |
| 70 mm       | 220 mm       | 12              | 215500700 |              |
| 80 mm       | 225 mm       | 12              | 215500800 |              |
| 90 mm       | 230 mm       | 12              | 215500900 |              |
| 100 mm      | 234 mm       | 12              | 215501000 |              |

Paint Scrapers with Carbon Steel Blade and Plastic Handle



**216**

| Blade Width | Blade Length | Blade Thickness | Quantity  | Product Code |
|-------------|--------------|-----------------|-----------|--------------|
| 30 mm       | 210 mm       | 12              | 216000300 |              |
| 40 mm       | 210 mm       | 12              | 216000400 |              |
| 50 mm       | 210 mm       | 12              | 216000500 |              |
| 60 mm       | 210 mm       | 12              | 216000600 |              |
| 70 mm       | 210 mm       | 12              | 216000700 |              |
| 80 mm       | 210 mm       | 12              | 216000800 |              |
| 90 mm       | 228 mm       | 12              | 216000900 |              |
| 100 mm      | 230 mm       | 12              | 216001000 |              |
| 120 mm      | 230 mm       | 12              | 216001200 |              |

Paint Scrapers with Carbon Steel Blade and Dual-Component Handle



**2150**

| Blade Width | Blade Length | Blade Thickness | Quantity  | Product Code |
|-------------|--------------|-----------------|-----------|--------------|
| 30 mm       | 225 mm       | 12              | 215000030 |              |
| 40 mm       | 225 mm       | 12              | 215000040 |              |
| 50 mm       | 225 mm       | 12              | 215000050 |              |
| 60 mm       | 225 mm       | 12              | 215000060 |              |
| 70 mm       | 225 mm       | 12              | 215000070 |              |
| 80 mm       | 225 mm       | 12              | 215000080 |              |
| 90 mm       | 220 mm       | 12              | 215000090 |              |
| 100 mm      | 220 mm       | 12              | 215000100 |              |
| 120 mm      | 220 mm       | 12              | 215000120 |              |

Paint Scrapers with Stainless Steel Blade and Dual-Component Handle



**2161**

| Blade Width | Blade Length | Blade Thickness | Quantity  | Product Code |
|-------------|--------------|-----------------|-----------|--------------|
| 40 mm       | 215 mm       | 12              | 216100040 |              |
| 60 mm       | 215 mm       | 12              | 216100060 |              |
| 80 mm       | 215 mm       | 12              | 216100080 |              |
| 100 mm      | 235 mm       | 12              | 216100100 |              |
| 120 mm      | 235 mm       | 12              | 216100120 |              |

Paint Scrapers with Rigid Blade and Plastic Handle



**2165**

| Blade Width | Blade Length | Blade Thickness | Quantity  | Product Code |
|-------------|--------------|-----------------|-----------|--------------|
| 30 mm       | 180 mm       | 12              | 216500300 |              |
| 50 mm       | 180 mm       | 12              | 216500500 |              |
| 75 mm       | 200 mm       | 12              | 216500750 |              |
| 100 mm      | 200 mm       | 12              | 216501000 |              |

Filling Scrapers with Carbon Steel Blade and Wooden Handle



**2190**

| Blade Width | Blade Length | Blade Thickness | Quantity  | Product Code |
|-------------|--------------|-----------------|-----------|--------------|
| 100 mm      | 235 mm       | 5               | 219001000 |              |
| 120 mm      | 230 mm       | 5               | 219001200 |              |
| 140 mm      | 245 mm       | 5               | 219001400 |              |
| 160 mm      | 235 mm       | 5               | 219001600 |              |
| 200 mm      | 245 mm       | 5               | 219002000 |              |

Filling Scrapers with Stainless Steel Blade and Wooden Handle



**2192**

| Blade Width | Blade Length | Blade Thickness | Quantity  | Product Code |
|-------------|--------------|-----------------|-----------|--------------|
| 100 mm      | 235 mm       | 5               | 219201000 |              |
| 120 mm      | 230 mm       | 5               | 219201200 |              |
| 140 mm      | 235 mm       | 5               | 219201400 |              |
| 160 mm      | 245 mm       | 5               | 219201600 |              |
| 200 mm      | 235 mm       | 5               | 219202000 |              |

Filling Scrapers with Reinforced Stainless Steel Blade and Wooden Handle



**2193**

| Blade Width | Blade Length | Blade Thickness | Quantity  | Product Code |
|-------------|--------------|-----------------|-----------|--------------|
| 250 mm      |              | 10              | 219302500 |              |
| 300 mm      |              | 10              | 219303000 |              |
| 350 mm      |              | 10              | 219303500 |              |



Glue Comb Scrapers with Triangular Teeth



**2212**

| Icon 1 | Icon 2 | Icon 3 | Icon 4    |
|--------|--------|--------|-----------|
|        |        |        |           |
| 130 mm | 120 mm | 5      | 221201200 |
| 130 mm | 200 mm | 5      | 221202000 |
| 130 mm | 300 mm | 5      | 221203000 |

Putty Knives with Stainless Steel Blade and Dual-Component Handle



**2489**

| Icon 1 | Icon 2 | Icon 3 | Icon 4 |
|--------|--------|--------|--------|
|        |        |        |        |
| 12     | 2489   |        |        |

Masonry Trowels with Sharp Tipped Blade and Wooden Handle



**2308**

| Icon 1 | Icon 2 | Icon 3 | Icon 4    |
|--------|--------|--------|-----------|
|        |        |        |           |
| 120 mm | 70 mm  | 6      | 2308A0000 |
| 150 mm | 100 mm | 6      | 2308B0000 |

## MASONRY TOOLS

Glue Comb Scrapers with Square Teeth



**2213**

| Icon 1 | Icon 2 | Icon 3 | Icon 4    |
|--------|--------|--------|-----------|
|        |        |        |           |
| 130 mm | 120 mm | 5      | 221301200 |
| 130 mm | 200 mm | 5      | 221302000 |
| 130 mm | 300 mm | 5      | 221303000 |

Madrid Model Masonry Trowels with Wooden Handle



**2303**

| Icon 1 | Icon 2 | Icon 3 | Icon 4    |
|--------|--------|--------|-----------|
|        |        |        |           |
| 70 mm  | 110 mm | 6      | 2303B0000 |
| 80 mm  | 135 mm | 6      | 2303D0000 |

Plastering Trowels with Carbon Steel Blade and Wooden Handle



**204**

| Icon 1 | Icon 2 | Icon 3 | Icon 4    |
|--------|--------|--------|-----------|
|        |        |        |           |
| 300 mm | 150 mm | 12     | 204030150 |
| 300 mm | 160 mm | 12     | 204030160 |
| 300 mm | 180 mm | 12     | 204030180 |
| 500 mm | 130 mm | 6      | 204050130 |

Hook Knives with Stainless Steel Blade and Dual-Component Handle



**2488**

| Icon 1 | Icon 2 | Icon 3 | Icon 4 |
|--------|--------|--------|--------|
|        |        |        |        |
| 12     | 2488   |        |        |

Sevilla Model Masonry Trowels with Wooden Handle



**2304**

| Icon 1 | Icon 2 | Icon 3 | Icon 4    |
|--------|--------|--------|-----------|
|        |        |        |           |
| 115 mm | 200 mm | 6      | 2304C0000 |

Plastering Trowels with Triangle Serrated Teeth Carbon Steel Blade and Wooden Handle



**209**

| Icon 1 | Icon 2 | Icon 3 | Icon 4    |
|--------|--------|--------|-----------|
|        |        |        |           |
| 270 mm | 115 mm | 12     | 209027040 |

Plastering Trowels with Square Serrated Teeth Carbon Steel Blade and Wooden Handle



**2092**



|        |        |    |           |
|--------|--------|----|-----------|
| 275 mm | 115 mm | 12 | 209227060 |
| 280 mm | 130 mm | 12 | 209228100 |
| 500 mm | 130 mm | 6  | 209250100 |

Plastering Trowels with Plastic Blade and Polystyrene Handle



**211**



|        |        |   |           |
|--------|--------|---|-----------|
| 350 mm | 180 mm | 5 | 211035180 |
| 420 mm | 210 mm | 5 | 211042210 |

Aluminium Plastering Scribes with Long Handle



**2127**

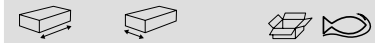

|       |        |   |           |
|-------|--------|---|-----------|
| 90 mm | 435 mm | 6 | 212704350 |
|-------|--------|---|-----------|

Plastering Trowels with Stainless Steel Blade and Long Poplar Wooden Handle



**2045**



|        |        |    |           |
|--------|--------|----|-----------|
| 300 mm | 140 mm | 12 | 204530140 |
| 500 mm | 130 mm | 6  | 204550130 |

Plastering Trowels with Notched Base and Polystyrene Handle



**2120**

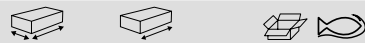

|        |        |   |           |
|--------|--------|---|-----------|
| 270 mm | 180 mm | 5 | 212027180 |
| 330 mm | 220 mm | 8 | 212033220 |

Flat and Serrated Plasterer's Rails with Wooden Handle



**2145xxxD**



|                  |   |           |
|------------------|---|-----------|
| 45 x 20 x 275 mm | 1 | 2145020D0 |
| 45 x 25 x 275 mm | 1 | 2145025D0 |
| 45 x 30 x 275 mm | 1 | 2145030D0 |
| 45 x 35 x 275 mm | 1 | 2145035D0 |

Plastering Trowels with Stainless Steel Blade and Light Poplar Wooden Handle



**2045A**

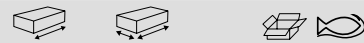

|        |        |    |           |
|--------|--------|----|-----------|
| 140 mm | 300 mm | 12 | 2045A3000 |
|--------|--------|----|-----------|

Notched Base Plastering Trowels with Polystyrene Handle



**213**



|        |        |   |           |
|--------|--------|---|-----------|
| 265 mm | 140 mm | 5 | 213026140 |
|--------|--------|---|-----------|

Flat Plasterer's Rails with Wooden Handle



**2145xxxL**



|                  |   |           |
|------------------|---|-----------|
| 45 x 20 x 275 mm | 1 | 2145020L0 |
| 45 x 25 x 275 mm | 1 | 2145025L0 |
| 45 x 30 x 275 mm | 1 | 2145030L0 |
| 45 x 35 x 275 mm | 1 | 2145035L0 |





Curved Plasterer's Rails with Wooden Handle



**2145xxxC**

|                  |   |           |  |
|------------------|---|-----------|--|
|                  |   |           |  |
| 45 x 25 x 225 mm | 1 | 2145025C0 |  |
| 45 x 35 x 210 mm | 1 | 2145039C0 |  |

Hard Rubber Grout Float Plastering Trowels with Anti-Shock Polystyrene Handle



**2125**

|        |        |    |           |
|--------|--------|----|-----------|
|        |        |    |           |
| 220 mm | 135 mm | 10 | 212502150 |



Board Filter Cable



**250400020**

|       |             |
|-------|-------------|
|       |             |
| 180 g | 1 250400020 |

Joints Plastering Trowels with Anti-Shock Polystyrene Handle



**2122**

|        |        |    |           |
|--------|--------|----|-----------|
|        |        |    |           |
| 250 mm | 100 mm | 10 | 212202500 |



Soft Rubber Grout Float Plastering Trowels with Anti-Shock Polystyrene Handle



**2126**

|        |        |    |           |
|--------|--------|----|-----------|
|        |        |    |           |
| 140 mm | 220 mm | 10 | 212602150 |
| 140 mm | 280 mm | 1  | 212602800 |



Board Filter Parts Set



**250400030**

|      |             |
|------|-------------|
|      |             |
| 80 g | 1 250400030 |

Sponge Base Plastering Trowels with Anti-Shock Polystyrene Handle and Hanging Clip



**2123**

|        |        |    |           |
|--------|--------|----|-----------|
|        |        |    |           |
| 140 mm | 280 mm | 10 | 212302900 |



## DRYWALL TOOLS

Lift Spare Set with 2 Springs and Brakes



**250400010**

|      |             |
|------|-------------|
|      |             |
| 80 g | 1 250400010 |

Setting Tools for Metal Anchors



**250501800**

|        |              |
|--------|--------------|
|        |              |
| 185 mm | 50 250501800 |



Setting Tools for Metal Anchors with Sprung Handle



**250502450**



245 mm



1 250502450



Spare Mitres for 864 Trim Cutter



**864000020**



20 g



1 864000020

Punching Tools for Dry Lining Walls



**671002600**



260 mm



50 671002600



Trim Cutters with Variable Angle



**8640**



230 mm



50 864002450



Adjustable Trim Cutters



**8641**



245 mm



1 864102400



Punching Tools with Articulated Head for Dry Lining Walls



**671002850**



295 mm



1 671002850



Spare Blades for 8640 Trim Cutter



**864000010**



20 g



1 864000010

Spare Blades for 8641 Trim Cutter



**864100010**



5 g



1 864100010





**BAHCO**



## Hand Hacksaws



## HAND HACKSAW FRAMES

ERGO™ Professional Hand Hacksaw Frames 300 mm



ergo



**325**

|        |   |     |
|--------|---|-----|
|        |   |     |
| 300 mm | 5 | 325 |

Professional Hand Hacksaw Frames with Aluminium Handle 300 mm



**225-PLUS**

|        |   |          |
|--------|---|----------|
|        |   |          |
| 300 mm | 5 | 225-PLUS |

Professional Hand Hacksaw Frames with Soft Grip Handle 300 mm



**319**

|        |   |     |
|--------|---|-----|
|        |   |     |
| 300 mm | 5 | 319 |

Hand Hacksaw Frames 432 mm



**317**

|        |    |     |
|--------|----|-----|
|        |    |     |
| 432 mm | 10 | 317 |

Compact Hand Hacksaw Frames 470 mm



**306**

|        |    |     |
|--------|----|-----|
|        |    |     |
| 440 mm | 10 | 306 |

Traditional Hand Hacksaw Frames 504 mm



**320**

|        |    |     |
|--------|----|-----|
|        |    |     |
| 504 mm | 10 | 320 |

Traditional Hand Hacksaw Frames 517 mm



**304**

|        |    |     |
|--------|----|-----|
|        |    |     |
| 517 mm | 10 | 304 |

Mini Hacksaws with Sandflex® Bi-Metal Blade



**208**

|        |   |     |
|--------|---|-----|
|        |   |     |
| 330 mm | 5 | 208 |

Compass Saws 8 Blade Positions



**321**

|       |   |     |
|-------|---|-----|
|       |   |     |
| 330 g | 5 | 321 |

Compass Saws 4 Blade Positions



**210**

|       |    |     |
|-------|----|-----|
|       |    |     |
| 360 g | 10 | 210 |



Junior Hacksaws with Steel Frame and Fibreglass Handle 150 mm



**268**

|        |   |     |
|--------|---|-----|
|        |   |     |
| 150 mm | 5 | 268 |

Junior Hacksaws with Steel Wire Frame and Handle 290 mm



**239**

|        |     |     |
|--------|-----|-----|
|        |     |     |
| 260 mm | 150 | 239 |

Junior High-Arch Hacksaws with Steel Profile Frame and Wooden Handle 150 mm



**238**

|        |    |     |
|--------|----|-----|
|        |    |     |
| 150 mm | 60 | 238 |

Junior Hacksaws with Steel Profile Frame and Wooden Handle 150 mm



**228**

|        |    |          |
|--------|----|----------|
|        |    |          |
| 150 mm | 80 | 228      |
| 150 mm | 5  | 228-BULK |

Junior Hacksaws with Steel Wire Frame and Wooden Handle 291 mm



**219**

|        |     |     |
|--------|-----|-----|
|        |     |     |
| 291 mm | 120 | 219 |

Junior Hacksaws with Steel Wire Frame and Handle 235 mm



**218**

|        |     |          |
|--------|-----|----------|
|        |     |          |
| 235 mm | 10  | 218      |
| 235 mm | 150 | 218-BULK |

**HAND HACKSAW BLADES**

Sandflex® Bi-Metal Spiro Hand Hacksaw Blades



**3806-SPIRO**

|        |    |                |
|--------|----|----------------|
|        |    |                |
| 600 mm | 32 | 10 3806-600-32 |

Sandflex® Bi-Metal Hand Hacksaw Blades



**3906**

|        |          |                       |
|--------|----------|-----------------------|
|        |          |                       |
| 250 mm | 18       | 100 3906-250-18-100   |
| 250 mm | 24       | 100 3906-250-24-100   |
| 250 mm | 32       | 100 3906-250-32-100   |
| 300 mm | 14       | 100 3906-300-14-100   |
| 300 mm | 18       | 100 3906-300-18-100   |
| 300 mm | 24       | 100 3906-300-24-100   |
| 300 mm | 32       | 100 3906-300-32-100   |
| 300 mm | 18-28    | 100 3818-300-PROG-100 |
| 300 mm | 14       | 10 3906-300-14-10P    |
| 300 mm | 18       | 10 3906-300-18-10P    |
| 300 mm | 24       | 10 3906-300-24-10P    |
| 300 mm | 32       | 10 3906-300-32-10P    |
| 250 mm | 18       | 10 3906-250-18-5P     |
| 250 mm | 24       | 10 3906-250-24-5P     |
| 250 mm | 32       | 10 3906-250-32-5P     |
| 300 mm | 14       | 10 3906-300-14-5P     |
| 300 mm | 18       | 10 3906-300-18-5P     |
| 300 mm | 24       | 10 3906-300-24-5P     |
| 300 mm | 32       | 10 3906-300-32-5P     |
| 300 mm | 18-28    | 10 3818-300-PROG-5P   |
| 300 mm | 18/24/32 | 10 3906-300-3P        |
| 300 mm | 18       | 10 3906-300-18-2P     |
| 300 mm | 24       | 10 3906-300-24-2P     |
| 300 mm | 32       | 10 3906-300-32-2P     |



Sandcut® High Speed Steel Hand Hacksaw Blades



**3905**

| L      | Teeth | Quantity | Part Number     |
|--------|-------|----------|-----------------|
| 250 mm | 24    | 100      | 3905-250-24-100 |
| 300 mm | 14    | 100      | 3905-300-14-100 |
| 300 mm | 18    | 100      | 3905-300-18-100 |
| 300 mm | 24    | 100      | 3905-300-24-100 |
| 300 mm | 32    | 100      | 3905-300-32-100 |
| 300 mm | 24    | 10       | 3905-300-24-2P  |

Junior Hacksaw Spare Blades



**228-P**

| L      | Teeth | Quantity | Part Number |
|--------|-------|----------|-------------|
| 150 mm | 15    | 10       | 228-15-5P   |
| 150 mm | 32    | 10       | 228-32-5P   |
| 150 mm | 32    | 10       | 228-32-10P  |
| 150 mm | 32    | 1        | 228-32-100P |

Tungsten Carbide Grit Hand Hacksaw Blade



**3816**

| L      | Teeth | Quantity | Part Number |
|--------|-------|----------|-------------|
| 300 mm | 12    | 50       | 3816-300    |

Junior Hacksaw Rod Blades 150-300 mm



**216-R**

| L      | Teeth | Quantity | Part Number |
|--------|-------|----------|-------------|
| 150 mm | 20    | 1        | 216-150-R   |
| 300 mm | 20    | 1        | 216-300-R   |

Junior Hacksaw Rod Blades 150 mm



**215**

| L      | Teeth | Quantity | Part Number |
|--------|-------|----------|-------------|
| 150 mm | 110   | 1        | 215-150     |

Sandflex® Interchangeable Compass Hand Hacksaw Blades



**321-SB**

| L      | Teeth | Quantity | Part Number |
|--------|-------|----------|-------------|
| 310 mm | 7     | 10       | 321-7-SB    |
| 310 mm | 18    | 10       | 321-18-SB   |
| 310 mm | 24    | 10       | 321-24-SB   |



## Handsaws



## HANDSAWS FOR CONSTRUCTION MATERIAL

ProfCut™ Toolbox General Purpose Handsaws



### PC-GNP

|        |       |   |           |
|--------|-------|---|-----------|
|        |       |   |           |
| 375 mm | 15/16 | 4 | PC-15-GNP |



PrizeCut™ Compass Saws for Wood/Plastic



### NP-COM

|        |     |   |           |
|--------|-----|---|-----------|
|        |     |   |           |
| 300 mm | 7/8 | 4 | NP-12-COM |



ProfCut™ Handsaws for Plaster/Boards of Wood Based Materials



### PC-PLS

|        |     |   |           |
|--------|-----|---|-----------|
|        |     |   |           |
| 600 mm | 7/8 | 4 | PC-24-PLS |



Superior™ General Purpose Sawblades, Used with ERGO™ EX Handles



### EX-16-GNP-C

|        |       |    |             |
|--------|-------|----|-------------|
|        |       |    |             |
| 400 mm | 15/16 | 10 | EX-16-GNP-C |



ProfCut™ Compass Saws for Wood/Plastic



### PC-COM

|        |      |   |           |
|--------|------|---|-----------|
|        |      |   |           |
| 300 mm | 9/10 | 4 | PC-12-COM |



Superior™ Sawblades for Plaster and Boards, Used with ERGO™ EX Handles



### EX-22-PLS-C

|        |     |    |             |
|--------|-----|----|-------------|
|        |     |    |             |
| 550 mm | 7/8 | 10 | EX-22-PLS-C |



Superior™ Compass Saws for Wood/Plastic



### 3150

|        |      |   |                |
|--------|------|---|----------------|
|        |      |   |                |
| 300 mm | 9/10 | 4 | 3150-12-XT9-HP |



Compass Saws for Plaster/Drywall/Boards of Wood Based Materials



### PC-6-DRY

|        |   |   |          |
|--------|---|---|----------|
|        |   |   |          |
| 160 mm | 8 | 6 | PC-6-DRY |



ProfCut™ Handsaws for Hard Plastic Tubes/Profiles



### PC-22-PLC

|        |       |   |           |
|--------|-------|---|-----------|
|        |       |   |           |
| 550 mm | 11/12 | 4 | PC-22-PLC |



ProfCut™ Handsaws for Polystyrene/  
Stucco Profiles/Foams



**PC-DECO**

|        |       |   |            |
|--------|-------|---|------------|
|        |       |   |            |
| 400 mm | 18/19 | 4 | PC-16-DECO |



ProfCut™ Handsaws for Lightweight  
Concrete/Leca®/Bricks



**256**

|        |   |   |        |
|--------|---|---|--------|
|        |   |   |        |
| 650 mm | 2 | 4 | 256-26 |



General Purpose Handsaws for Plastics/  
Laminates/Wood/Soft Metals



**300**

|        |       |   |                  |
|--------|-------|---|------------------|
|        |       |   |                  |
| 350 mm | 15/16 | 4 | 300-14-F15/16-HP |



ProfCut™ Handsaws for Lightweight  
Concrete/Leca®/Bricks 1.3 TPI



**255-34**

|        |     |   |        |
|--------|-----|---|--------|
|        |     |   |        |
| 620 mm | 1,3 | 2 | 255-34 |



Insulation Saws for Mineral Wool/Stone  
Wool/Eco Wool/Styrex®



**PC-22-INS**

|        |    |   |           |
|--------|----|---|-----------|
|        |    |   |           |
| 550 mm | WT | 4 | PC-22-INS |



General Purpose Spare Sawblades



**369**

|        |       |    |           |
|--------|-------|----|-----------|
|        |       |    |           |
| 360 mm | 13/14 | 20 | 369-BLADE |



ProfCut™ Handsaws for Lightweight  
Concrete/Leca®/Bricks 0.6 TPI



**255-17/34**

|        |     |   |           |
|--------|-----|---|-----------|
|        |     |   |           |
| 620 mm | 0.6 | 2 | 255-17/34 |



Folding Saw Specifically for Cutting  
Insulation Wool Material



**396-INS**

|        |    |    |         |
|--------|----|----|---------|
|        |    |    |         |
| 190 mm | WT | 10 | 396-INS |



PrizeCut™ Universal Handsaws for  
Plastics/Laminates/Wood/Soft Metals



**NP**

|        |     |    |               |
|--------|-----|----|---------------|
|        |     |    |               |
| 400 mm | 7/8 | 4  | NP-16-U7/8-HP |
| 475 mm | 7/8 | 10 | NP-19-U7/8-HP |
| 550 mm | 7/8 | 10 | NP-22-U7/8-HP |



**HANDSAWS FOR WOOD**





PrizeCut™ Sawblades for Fine to Medium Thick Materials, Used with ERGO™ EX Handles



**EX-NPP-22**

|        |     |    |           |
|--------|-----|----|-----------|
|        |     |    |           |
| 550 mm | 7/8 | 10 | EX-NPP-22 |



PrizeCut™ Sawblades for All Types of Wood, Used with ERGO™ EX Handles



**EX-22-U7**

|        |     |    |          |
|--------|-----|----|----------|
|        |     |    |          |
| 550 mm | 7/8 | 10 | EX-22-U7 |



ERGO™ Superior™ Toolbox Saws for Plaster/Boards of Wood Based Materials



**2600-16**

|        |       |   |                 |
|--------|-------|---|-----------------|
|        |       |   |                 |
| 400 mm | 11/12 | 4 | 2600-16-XT11-HP |



Superior™ Sawblades for Medium to Thick Material, Used with ERGO™ EX Handles



**EX-XT9**

|        |      |    |             |
|--------|------|----|-------------|
|        |      |    |             |
| 475 mm | 9/10 | 10 | EX-19-XT9-C |
| 550 mm | 9/10 | 10 | EX-22-XT9-C |



ProfCut™ Hardpoint Handsaws for Plaster/Boards of Wood Based Materials



**PC-GT7**

|        |     |   |           |
|--------|-----|---|-----------|
|        |     |   |           |
| 475 mm | 7/8 | 4 | PC-19-GT7 |
| 550 mm | 7/8 | 4 | PC-22-GT7 |



ERGO™ Superior Tenon Saws for Plastics/Laminates/Wood/Soft Metals



**3180**

|        |       |   |                 |
|--------|-------|---|-----------------|
|        |       |   |                 |
| 350 mm | 11/12 | 4 | 3180-14-XT11-HP |



PrizeCut™ Crosscut Handsaws for Coarse/Medium Thick Wood Materials



**NP-FLEEM**

|        |   |    |               |
|--------|---|----|---------------|
|        |   |    |               |
| 550 mm | 7 | 10 | NP-22-F7/8-HP |



Fileable Universal Handsaws for Plastics/Laminates/Wood/Soft Metals



**PC-FILE**

|        |     |   |               |
|--------|-----|---|---------------|
|        |     |   |               |
| 400 mm | 7/8 | 4 | PC-16-FILE-U7 |
| 475 mm | 7/8 | 4 | PC-19-FILE-U7 |
| 550 mm | 7/8 | 4 | PC-22-FILE-U7 |
| 600 mm | 7/8 | 4 | PC-24-FILE-U7 |



ERGO™ Superior™ Veneer Handsaws for Plywood and Plastic



**3240**

|        |       |   |                 |
|--------|-------|---|-----------------|
|        |       |   |                 |
| 350 mm | 11/12 | 4 | 3240-14-XT11-HP |



ERGO™ Superior™ Saws for Plaster/  
Boards of Wood Based Materials



**2600**

|        |      |   |               |
|--------|------|---|---------------|
|        |      |   |               |
| 475 mm | 9/10 | 4 | 2600-19-XT-HP |
| 550 mm | 9/10 | 4 | 2600-22-XT-HP |



Handsaws for Plastics/Laminates/Wood/  
Soft Metals



**244**

|        |     |    |                |
|--------|-----|----|----------------|
|        |     |    |                |
| 500 mm | 7/8 | 10 | 244-20-U7/8-HP |
| 550 mm | 7/8 | 10 | 244-22-U7/8-HP |



Superior™ Sawblades for Fine to Medium  
Thick Materials, Used with ERGO™ EX  
Handles



**EX-20-XT11-C**

|        |       |    |              |
|--------|-------|----|--------------|
|        |       |    |              |
| 500 mm | 11/12 | 10 | EX-20-XT11-C |



Hardpoint Handsaws for Plastics/  
Laminates/Wood/Soft Metals



**2500 XT**

|        |       |   |                |
|--------|-------|---|----------------|
|        |       |   |                |
| 400 mm | 11/12 | 4 | 2500-16-XT-HP  |
| 475 mm | 9/10  | 4 | 2500-19-XT-HP  |
| 550 mm | 9/10  | 4 | 2500-22-XT-HP  |
| 600 mm | 7/8   | 4 | 2500-24-XT7-HP |



Superior™ Sawblades for Laminates and  
Wooden Floors, Used with ERGO™ EX  
Handles



**EX-20-LAM-C**

|        |       |    |             |
|--------|-------|----|-------------|
|        |       |    |             |
| 500 mm | 11/12 | 10 | EX-20-LAM-C |



Superior™ Tenon Sawblades for Plastics,  
Laminates, Wood and Soft Metals, Used  
with ERGO™ EX Handles



**EX-14-TEN-C**

|        |       |   |             |
|--------|-------|---|-------------|
|        |       |   |             |
| 350 mm | 11/12 | 5 | EX-14-TEN-C |



ProfCut™ Laminator Saws for Laminate/  
Wooden Floors



**PC-LAM**

|        |       |   |           |
|--------|-------|---|-----------|
|        |       |   |           |
| 500 mm | 11/12 | 4 | PC-20-LAM |



ERGO™ Superior™ Saws for Plastics/  
Laminates/Wood/Soft Metals



**3090**

|        |       |   |                 |
|--------|-------|---|-----------------|
|        |       |   |                 |
| 500 mm | 11/12 | 4 | 3090-20-XT11-HP |



ERGO™ Superior™ Laminator Saws for  
Laminate/Wooden Floors



**SUP-LAM**

|        |       |   |            |
|--------|-------|---|------------|
|        |       |   |            |
| 500 mm | 11/12 | 4 | SUP-20-LAM |



Superior™ Veneer Sawblades for  
Plywood/Plastic, Used with ERGO™ EX  
Handles



**EX-14-VEN-C**

|        |       |    |             |
|--------|-------|----|-------------|
|        |       |    |             |
| 350 mm | 11/12 | 10 | EX-14-VEN-C |



ProfCut™ Hardpoint Handsaws for Hard Wood/Plywood/Thin Profile



**PC-GT9**

|        |      |   |           |
|--------|------|---|-----------|
|        |      |   |           |
| 475 mm | 9/10 | 4 | PC-19-GT9 |
| 550 mm | 9/10 | 4 | PC-22-GT9 |

PrizeCut™ Hardpoint Sawblades for Fine/Medium Thick Material



**PC-VEN**

|        |       |   |           |
|--------|-------|---|-----------|
|        |       |   |           |
| 300 mm | 11/12 | 4 | PC-12-VEN |

PrizeCut™ Veneer Saws for Fine/Medium Thick Material



**NP-VEN**

|        |       |    |           |
|--------|-------|----|-----------|
|        |       |    |           |
| 300 mm | 13/14 | 10 | NP-12-VEN |

ProfCut™ Toolbox Handsaws for Fine to Medium Thick Materials



**PC-TBX**

|        |       |   |           |
|--------|-------|---|-----------|
|        |       |   |           |
| 375 mm | 11/12 | 4 | PC-15-TBX |

ProfCut™ Sawblades for Fine/Medium Thick Material



**PC-PRC**

|        |      |   |           |
|--------|------|---|-----------|
|        |      |   |           |
| 500 mm | 9/10 | 4 | PC-20-PRC |

Superior™ Sawblades for Coarse/Thick Material, Used with ERGO™ EX Handles



**EX-XT7**

|        |     |    |             |
|--------|-----|----|-------------|
|        |     |    |             |
| 550 mm | 7/8 | 10 | EX-22-XT7-C |
| 600 mm | 7/8 | 10 | EX-24-XT7-C |

ProfCut™ Tenon Handsaws for Medium Thick Materials



**PC-TEN**

|        |       |   |           |
|--------|-------|---|-----------|
|        |       |   |           |
| 300 mm | 11/12 | 4 | PC-12-TEN |

PrizeCut™ Tenon Saws for Fine/Medium Thick Material



**NP-TEN**

|        |       |    |           |
|--------|-------|----|-----------|
|        |       |    |           |
| 300 mm | 13/14 | 10 | NP-12-TEN |

Barracuda Sawblades for Medium to Thick Materials, Used with ERGO™ EX Handles



**EX-244P-22**

|        |     |    |            |
|--------|-----|----|------------|
|        |     |    |            |
| 550 mm | 7/8 | 10 | EX-244P-22 |

Handsaws with Dual-Component for Medium to Thick Wood



**244P**

|        |     |    |               |
|--------|-----|----|---------------|
|        |     |    |               |
| 500 mm | 7/8 | 4  | 244P-20-U7-HP |
| 550 mm | 7/8 | 10 | 244P-22-U7-HP |



Wooden Mitre Boxes with Optional Side Wall



**233**

|                   |             |
|-------------------|-------------|
|                   |             |
| 65 x 135 x 300 mm | 5 233-300   |
| 75 x 135 x 300 mm | 5 233-300-A |
| 65 x 135 x 400 mm | 5 233-400   |



**PRECISION HANDSAWS**

ProfCut™ General Carpentry Pull-Saws for Wood and Plastic



**PC-12-PS**

|        |      |    |               |
|--------|------|----|---------------|
|        |      |    |               |
| 305 mm | 13.5 | 4  | PC-12-14-PS   |
| 305 mm | 13.5 | 10 | PC-12-14-PS-B |



ERGO™ Superior Handsaws for Timber/Wet/Tanalised Wood



**2700**

|        |     |   |                |
|--------|-----|---|----------------|
|        |     |   |                |
| 550 mm | 7/8 | 4 | 2700-22-XT7-HP |
| 600 mm | 7/8 | 4 | 2700-24-XT7-HP |



Laminated Wood Mitre Boxes



**234-W**

|                   |           |
|-------------------|-----------|
|                   |           |
| 53 x 77 x 245 mm  | 10 234-W1 |
| 63 x 95 x 300 mm  | 10 234-W2 |
| 80 x 100 x 300 mm | 10 234-W3 |



ProfCut™ Tenon Pull-Saws for Wood and Plastic



**PC-11-PS**

|        |      |    |               |
|--------|------|----|---------------|
|        |      |    |               |
| 270 mm | 18.5 | 4  | PC-11-19-PS   |
| 270 mm | 18.5 | 10 | PC-11-19-PS-B |



ProfCut™ Timber Saws for Timber/Wet/Tanalised Wood



**PC-TIM**

|        |         |   |           |
|--------|---------|---|-----------|
|        |         |   |           |
| 600 mm | 3.5/4.5 | 4 | PC-24-TIM |



Aluminium Mitre Boxes

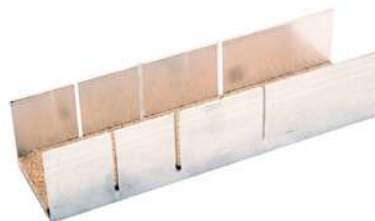

**234-A**

|                   |          |
|-------------------|----------|
|                   |          |
| 55 x 65 x 245 mm  | 1 234-A1 |
| 40 x 106 x 245 mm | 1 234-A2 |



ProfCut™ Double Edge Pull-Saws for Wood and Plastic



**PC-9-PS**

|        |            |    |                |
|--------|------------|----|----------------|
|        |            |    |                |
| 240 mm | 6-8.5 / 17 | 4  | PC-9-9/17-PS   |
| 240 mm | 6-8.5 / 17 | 10 | PC-9-9/17-PS-B |



ProfCut™ Dovetail Saws with Angled Swinging Wooden Handle



**PC-DTF**

|        |       |    |           |
|--------|-------|----|-----------|
|        |       |    |           |
| 250 mm | 15/16 | 10 | PC-10-DTF |



**HANDLES & SHARPENERS**

ERGO™ BHS Handle for EX Sawblade Large



**EX-**

|                   |   |       |
|-------------------|---|-------|
|                   |   |       |
| 120 x 330 x 60 mm | 4 | EX-LL |
| 120 x 330 x 60 mm | 4 | EX-RM |
| 120 x 330 x 60 mm | 4 | EX-RL |



Fret Saws with Frame and Wooden Handle



**502**

|        |    |     |
|--------|----|-----|
|        |    |     |
| 130 mm | 25 | 502 |



ProfCut™ Dovetail Saws with Straight Wooden Handle



**PC-DTR**

|        |       |    |           |
|--------|-------|----|-----------|
|        |       |    |           |
| 250 mm | 15/16 | 10 | PC-10-DTR |



Professional High Speed Steel Sharpeners



**SHARP-INS**

|        |     |           |
|--------|-----|-----------|
|        |     |           |
| 206 mm | 100 | SHARP-INS |



Fret Saw Sets, 2 pieces



**502-SET2**

|   |       |    |          |
|---|-------|----|----------|
|   |       |    |          |
| 2 | 130 g | 35 | 502-SET2 |



ProfCut™ Dovetail Saws with Angled Wooden Handle



**PC-DTL**

|        |       |    |           |
|--------|-------|----|-----------|
|        |       |    |           |
| 250 mm | 15/16 | 10 | PC-10-DTL |



Fret Saws with Wooden Handle



**302**

|        |    |     |
|--------|----|-----|
|        |    |     |
| 130 mm | 30 | 302 |



Fret Saw Sets, 6 pieces



**502-SET6**

|   |       |    |          |
|---|-------|----|----------|
|   |       |    |          |
| 6 | 500 g | 10 | 502-SET6 |



Assortment of Spare Blades for 302 and 502 Fret Saws



**302-6X4P**



130 mm



1 302-6X4P

Fret Saw Spare Blades for Wood and Plastic



**302W**



|    |        |   |              |
|----|--------|---|--------------|
| 1  | 130 mm | 1 | 302-51W-12P  |
| 3  | 130 mm | 1 | 302-53W-12P  |
| 5  | 130 mm | 1 | 302-55W-12P  |
| 7  | 130 mm | 1 | 302-57W-12P  |
| 9  | 130 mm | 1 | 302-59W-12P  |
| 11 | 130 mm | 1 | 302-511W-12P |

**MUSICAL SAW**

Musical Handsaws with Wooden Handle



**296**



750 mm



1 296

Fret Saw Spare Blades for Metal



**302M**



|   |        |   |             |
|---|--------|---|-------------|
| 1 | 130 mm | 1 | 302-71M-12P |
| 3 | 130 mm | 1 | 302-73M-12P |
| 5 | 130 mm | 1 | 302-75M-12P |
| 7 | 130 mm | 1 | 302-77M-12P |

**COPING SAWS & SAWBLADES**

Coping Saws with Wooden Handle



**301**



165 mm



50 301

Fret Saw Spiral Spare Blades for Wood and Plastic



**302S**



|   |        |   |             |
|---|--------|---|-------------|
| 1 | 130 mm | 1 | 302-81S-12P |
| 3 | 130 mm | 1 | 302-83S-12P |
| 5 | 130 mm | 1 | 302-85S-12P |

Coping Sawblades for 301 Saw

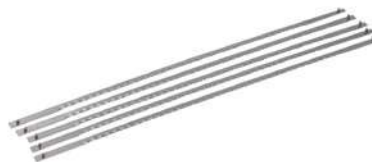

**303**



165 mm



10 303-5P



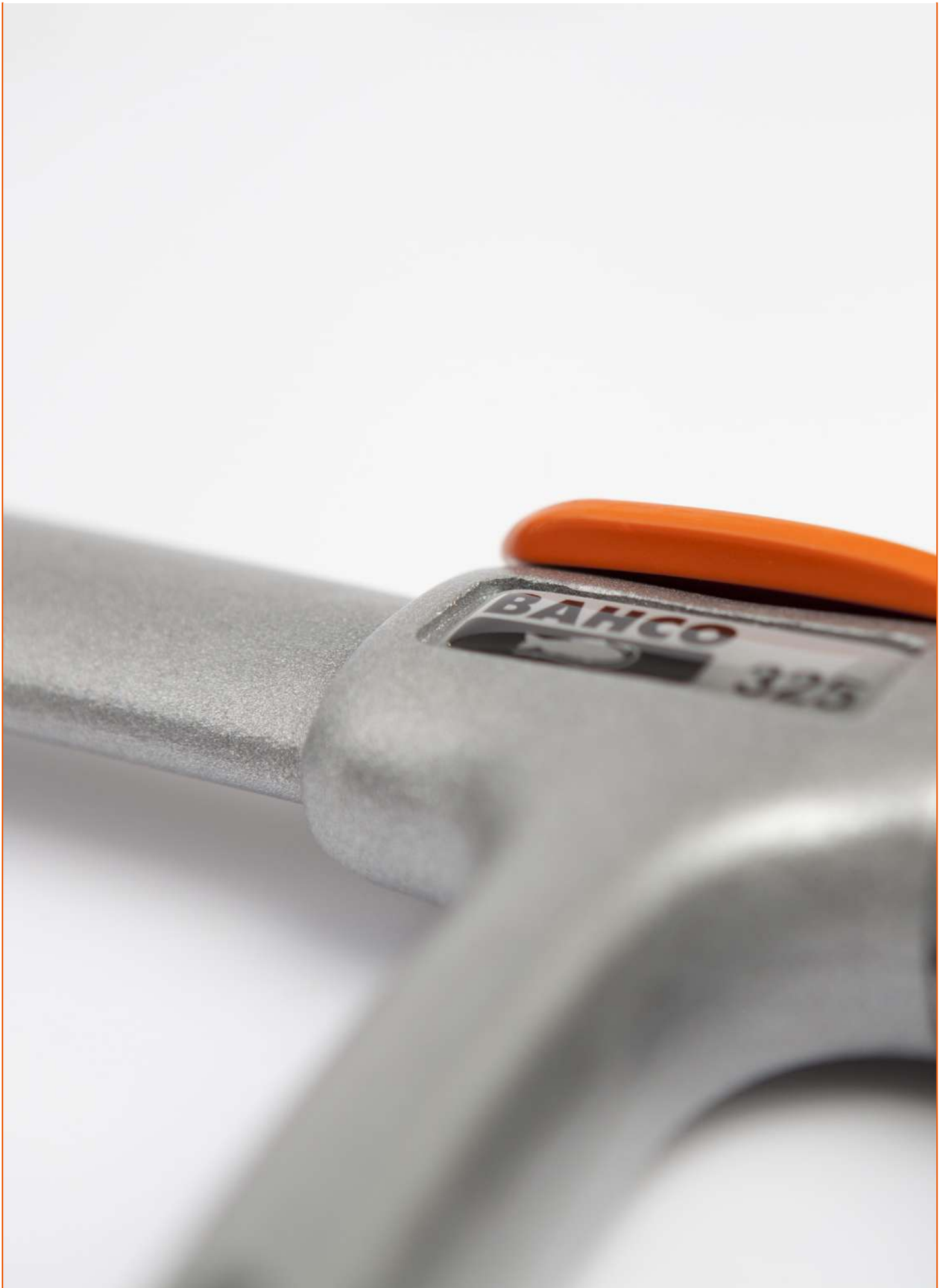

**BAHCO**



## Wood Chisels



## WOODWORKING CHISELS

ERGO™ Splitproof Woodworking Chisels



ergo



**434**

| Icon  | Icon | Icon   |
|-------|------|--------|
| 6 mm  | 4    | 434-6  |
| 8 mm  | 4    | 434-8  |
| 10 mm | 4    | 434-10 |
| 12 mm | 4    | 434-12 |
| 14 mm | 4    | 434-14 |
| 15 mm | 4    | 434-15 |
| 16 mm | 4    | 434-16 |
| 18 mm | 4    | 434-18 |
| 20 mm | 4    | 434-20 |
| 22 mm | 4    | 434-22 |
| 25 mm | 4    | 434-25 |
| 28 mm | 4    | 434-28 |
| 30 mm | 4    | 434-30 |
| 32 mm | 4    | 434-32 |
| 35 mm | 4    | 434-35 |
| 38 mm | 4    | 434-38 |
| 50 mm | 4    | 434-50 |

Suitable for an intensive use with a metallic hammer

ERGO™ Splitproof Chisel Set - 3 Pcs/  
Cardboard Box



ergo



**434-S3-EUR**

| Icon | Icon | Icon       |
|------|------|------------|
| 3    | 1    | 434-S3-EUR |

Suitable for an intensive use with a metallic hammer

434-12, 434-18, 434-25

6 pcs ERGO™ Splitproof chisel set in  
leather roll pouch.



ergo



**434-S6-LR**

| Icon | Icon | Icon      |
|------|------|-----------|
| 6    | 1    | 434-S6-LR |

Suitable for an intensive use with a metallic hammer

434-6, 434-10, 434-12, 434-18, 434-25, 434-32

ERGO™ Splitproof Chisel Set - 6 Pcs/  
Wooden Box



ergo



**434-S6-EUR**

| Icon | Icon | Icon       |
|------|------|------------|
| 6    | 1    | 434-S6-EUR |

Suitable for an intensive use with a metallic hammer

434-6, 434-10, 434-12, 434-18, 434-25, 434-32

ERGO™ Splitproof Chisel Set - 8 Pcs/  
Wooden Box



ergo



**434-S8-EUR**

| Icon | Icon | Icon       |
|------|------|------------|
| 8    | 1    | 434-S8-EUR |

Suitable for an intensive use with a metallic hammer

434-6, 434-10, 434-12, 434-16, 434-18, 434-25, 434-32, 434-38

ERGO™ Splitproof Chisel Set - 6 Pcs/  
Polyester Pouch



ergo



**434-S6-PP**

| Icon | Icon | Icon      |
|------|------|-----------|
| 6    | 1    | 434-S6-PP |

Suitable for an intensive use with a metallic hammer

434-6, 434-10, 434-12, 434-18, 434-25, 434-32

Woodworking Chisels with Rubberised  
Handle



**424P**

| Icon  | Icon | Icon    |
|-------|------|---------|
| 4 mm  | 4    | 424P-4  |
| 6 mm  | 4    | 424P-6  |
| 8 mm  | 4    | 424P-8  |
| 10 mm | 4    | 424P-10 |
| 12 mm | 4    | 424P-12 |
| 14 mm | 4    | 424P-14 |
| 15 mm | 4    | 424P-15 |
| 16 mm | 4    | 424P-16 |
| 18 mm | 4    | 424P-18 |
| 20 mm | 4    | 424P-20 |
| 22 mm | 4    | 424P-22 |
| 24 mm | 4    | 424P-24 |
| 25 mm | 4    | 424P-25 |
| 26 mm | 4    | 424P-26 |
| 28 mm | 4    | 424P-28 |
| 30 mm | 4    | 424P-30 |
| 32 mm | 4    | 424P-32 |
| 35 mm | 4    | 424P-35 |
| 38 mm | 4    | 424P-38 |
| 40 mm | 4    | 424P-40 |

Chisel Set with Rubberised Handle - 3  
Pcs/Cardboard Box



**424P-S3-EUR**

| Icon | Icon | Icon        |
|------|------|-------------|
| 3    | 1    | 424P-S3-EUR |

424P-12, 424P-18, 424P-25

Chisel Set with Rubberised Handle 6-32  
mm - 6 Pcs/Leather Roll Pouch



**424P-S6-LR**

| Icon | Icon | Icon       |
|------|------|------------|
| 6    | 1    | 424P-S6-LR |

424P-6, 424P-10, 424P-12, 424P-18, 424P-25, 424P-32

Chisel Set with Rubberised Handle - 6 Pcs/Wooden Box



**424P-S6-EUR**



6 1 424P-S6-EUR

424P-6, 424P-10, 424P-12, 424P-18, 424P-25, 424P-32



Chisel Set with Rubberised Handle - 6 Pcs/Wooden Box



**424P-S6-GER**



6 1 424P-S6-GER

424P-6, 424P-10, 424P-12, 424P-16, 424P-20, 424P-26



Chisel Set with Rubberised Handle - 8 Pcs/Wooden Box



**424P-S8-EUR**



8 1 424P-S8-EUR

424P-6, 424P-10, 424P-12, 424P-16, 424P-18, 424P-25, 424P-32, 424P-38



Chisel Set with Rubberised Handle - 6 Pcs/Polyester Pouch



**424P-S6-PP**



6 1 424P-S6-PP

424P-6, 424P-10, 424P-12, 424P-18, 424P-25, 424P-32



Woodworking Chisels with Orange Polypropylene Handle



**414**



- |       |   |        |
|-------|---|--------|
| 6 mm  | 4 | 414-6  |
| 8 mm  | 4 | 414-8  |
| 10 mm | 4 | 414-10 |
| 12 mm | 4 | 414-12 |
| 14 mm | 4 | 414-14 |
| 15 mm | 4 | 414-15 |
| 16 mm | 4 | 414-16 |
| 18 mm | 4 | 414-18 |
| 20 mm | 4 | 414-20 |
| 22 mm | 4 | 414-22 |
| 25 mm | 4 | 414-25 |
| 28 mm | 4 | 414-28 |
| 30 mm | 4 | 414-30 |
| 32 mm | 4 | 414-32 |
| 35 mm | 4 | 414-35 |
| 38 mm | 4 | 414-38 |



- |       |   |         |
|-------|---|---------|
| 10 mm | 5 | 1031-10 |
| 12 mm | 5 | 1031-12 |
| 14 mm | 5 | 1031-14 |
| 16 mm | 5 | 1031-16 |
| 18 mm | 5 | 1031-18 |
| 20 mm | 5 | 1031-20 |
| 22 mm | 5 | 1031-22 |
| 25 mm | 5 | 1031-25 |
| 28 mm | 5 | 1031-28 |
| 30 mm | 5 | 1031-30 |
| 32 mm | 5 | 1031-32 |
| 40 mm | 5 | 1031-40 |

Chisel Set with Polypropylene Handle - 3 Pcs/Cardboard Box



**414-S3-EUR**



3 1 414-S3-EUR

414-12, 414-18, 414-25



Chisel Set with Polypropylene Handle - 5 Pcs/Blister



**9883**



5 1 9883

1031-6, 1031-12, 1031-16, 1031-20, 1031-25





Woodworking Chisels with Wooden Handle



**425**

| Icon  | Icon     |
|-------|----------|
|       |          |
| 4 mm  | 4 425-4  |
| 6 mm  | 4 425-6  |
| 8 mm  | 4 425-8  |
| 10 mm | 4 425-10 |
| 12 mm | 4 425-12 |
| 14 mm | 4 425-14 |
| 15 mm | 4 425-15 |
| 16 mm | 4 425-16 |
| 18 mm | 4 425-18 |
| 20 mm | 4 425-20 |
| 22 mm | 4 425-22 |
| 24 mm | 4 425-24 |
| 25 mm | 4 425-25 |
| 26 mm | 4 425-26 |
| 28 mm | 4 425-28 |
| 30 mm | 4 425-30 |
| 32 mm | 4 425-32 |
| 35 mm | 4 425-35 |
| 38 mm | 4 425-38 |
| 40 mm | 4 425-40 |

Chisel Set with Wooden Handle - 5 Pcs/  
Cardboard Box



**425-082**

| Icon | Icon      |
|------|-----------|
|      |           |
| 5    | 1 425-082 |

425-6, 425-10, 425-12, 425-18, 425-25

Chisel Set with Wooden Handle - 6 Pcs/  
Wooden Box



**425-083**

| Icon | Icon      |
|------|-----------|
|      |           |
| 6    | 1 425-083 |

425-6, 425-10, 425-12, 425-18, 425-25, 425-32

3 pcs wooden-handle chisel set in  
cardboard box



**425-081**

| Icon | Icon      |
|------|-----------|
|      |           |
| 3    | 1 425-081 |

425-12, 425-18, 425-25

**GOUGE CHISELS**

Gouge Chisels with Rubberised Handle



**422P**

| Icon  | Icon      |
|-------|-----------|
|       |           |
| 6 mm  | 4 422P-6  |
| 10 mm | 4 422P-10 |
| 12 mm | 4 422P-12 |
| 16 mm | 4 422P-16 |
| 20 mm | 4 422P-20 |
| 25 mm | 4 422P-25 |

**DEMOLITION CHISELS**

Heavy Duty Wrecking Knives with  
Rubberised Handle



**2448**

| Icon  | Icon   | Icon       |
|-------|--------|------------|
|       |        |            |
| 25 mm | 231 mm | 12 2448    |
| 25 mm | 240 mm | 12 SB-2448 |

Heavy Duty Wrecking Knives with Curved  
Blade and Rubberised Handle



**2449**

| Icon  | Icon   | Icon       |
|-------|--------|------------|
|       |        |            |
| 25 mm | 235 mm | 12 2449    |
| 25 mm | 235 mm | 10 SB-2449 |

Spare Handles for 1031 Chisels



**956**

| Icon   | Icon | Icon  |
|--------|------|-------|
|        |      |       |
| 108 mm | 50 g | 1 956 |

## WOOD CHISEL ACCESSORIES

Natural Grinding Stones



**528-700**



150 mm



1 528-700

Sharpening block



**SBC110**



30 x 65 x 110 mm



67 g



1 SBC110-65

Grinding Stones with Two Grains



**528-COM**



150 mm



1 528-COM

Block Plane Spare Blade



**BP-40-95**



112 mm



55 g



12 BP-40-95

Grinding Plain



**BP-40**



160 mm



1 BP-40

Protective Plastic Holsters



**WC-HOL**



292 mm



1 WC-HOL





**BAHCO**



## Scissors & Knives



## METAL SHEARS

Straight Cut Aviation Shears with Increased Power by Lever Action and Yellow Colour Coded Handle up to 1.5 mm



**MA421**



250 mm



10 MA421

Multipurpose Long Straight Cut Aviation/Compound Shears with Orange Handle



**MA431**



290 mm



1 MA431

8698M0250: Spare parts set

Right Cut Aviation Shears with Increased Power by Lever Action and Green Colour Coded Handle up to 1.5 mm



**MA411**



250 mm



10 MA411

8698M0250: Spare parts set

Right Cut Aviation Shears with Increased Power by Lever Action and Green Colour Coded Handle up to 1.8 mm



**MA321**



260 mm



10 MA321

8697M0260: Spare parts set

Left Cut Aviation Shears with Increased Power by Lever Action and Red Colour Coded Handle up to 1.5 mm



**MA401**



250 mm



10 MA401

8698M0250: Spare parts set

Left Cut Aviation Shears with Increased Power by Lever Action and Red Colour Coded Handle up to 1.8 mm



**MA311**



260 mm



1 MA311

8697M0260: Spare parts set

Straight Cut Aviation Shears with Increased Power by Lever Action



**MA225**



250 mm



4 MA225

Right Cut Aviation Shears with Increased Power by Lever Action



**MA225R**



250 mm



4 MA225R

Left Cut Aviation Shears with Increased Power by Lever Action



**MA225L**



250 mm



4 MA225L



Right Cut Pass-Through Shears with Increased Power by Lever Action and Green Colour Coded Handle



**MA361**



260 mm 10 MA361

8697M0260: Spare parts set

Long Straight Cut Pass-Through Metal Shears



**MR340**



340 mm 2 MR340

Right and Straight Cut Offset Pass-Through Metal Shears for Soft/Medium Materials



**585D**

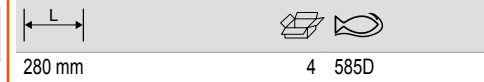

280 mm 4 585D

Left Cut Pass-Through Shears with Increased Power by Lever Action and Red Colour Coded Handle



**MA351**



250 mm 10 MA351

8697M0260: Spare parts set

Right and Straight Cut Offset Pass-Through Metal Shears for Medium/Hard Materials



**583D**



280 mm 4 583D

Left and Straight Cut Offset Pass-Through Metal Shears for Soft/Medium Materials



**586D**



280 mm 4 586D

Straight Cut Pass-Through Metal Shears with Increased Power by Lever Action



**MA325**



250 mm 4 MA325

Left and Straight Cut Offset Pass-Through Metal Shears for Medium/Hard Materials



**584D**



280 mm 4 584D

Left and Straight Cut Traditional/Industrial Metal Shears with Two Thin Blades



**M227L**

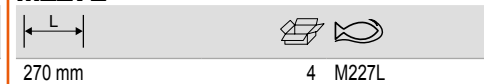

270 mm 4 M227L



Right and Straight Cut Traditional/Industrial Metal Shears with Two Thin Blades



**M227R**



270 mm



4 M227R

Right Cut Madrid Traditional/Industrial Metal Shears



**8691**



255 mm  
300 mm



6 869102500  
6 869103000

Right and Straight Cut Traditional/Industrial Metal Shears with Two Thin Blades and Return Spring



**MR227R**



270 mm



4 MR227R

Long Straight Cut Pass-Through Traditional/Industrial Shears



**M330**



11 3/4 mm



4 M330

Catalonian Traditional/Industrial Metal Shears



**8692**



300 mm



6 869203000

Straight Cut Pass-Through Two Hand Compound Shears



**M6376**



760 mm



1 M6376  
1 M6376-SH

Straight Cut Traditional/Industrial Metal Shears with Two Thick Blades



**M526**



260 mm



4 M526

Left and Straight Cut Traditional/Industrial Metal Shears with Two Thin Blades and Return Spring



**MR227L**



270 mm



4 MR227L

Straight Cut Two Hand Compound Shears



**M676**



760 mm



1 M676  
1 M676-SH

Metal Shears Nibblers with Eye Protecting Screen



**M926**

|        |                     |
|--------|---------------------|
|        |                     |
| 250 mm | 1 M926<br>1 M926-SH |

Heavy Duty Electrician Scissors with Groove



**SCB140G**

|                 |            |
|-----------------|------------|
|                 |            |
| 43 mm    140 mm | 10 SCB140G |

Electrician Scissors with Longer Handle



**SC150NG**

|                 |            |
|-----------------|------------|
|                 |            |
| 38 mm    155 mm | 10 SC150NG |

Multipurpose Heavy Duty Universal Snips



**2744**

|        |        |
|--------|--------|
|        |        |
| 190 mm | 6 2744 |

Electrician Scissors with Optional Serrated Blade



**SC127/SC127S**

|                 |           |
|-----------------|-----------|
|                 |           |
| 45 mm    130 mm | 10 SC127  |
| 45 mm    127 mm | 10 SC127S |

Special Tin Snips with Curved Cutting Jaws



**2704**

|        |         |
|--------|---------|
|        |         |
| 110 mm | 1 2704A |

**SCISSORS**

Heavy Duty Electrician Scissors



**SCB140**

|                 |           |
|-----------------|-----------|
|                 |           |
| 43 mm    140 mm | 10 SCB140 |

Electrician Scissors with Optional Curved Blade



**SC140/SC140C**

|                 |           |
|-----------------|-----------|
|                 |           |
| 50 mm    145 mm | 10 SC140  |
| 50 mm    145 mm | 10 SC140C |

Special Tin Forceps with Finely Serrated Jaws



**2705R**

|        |         |
|--------|---------|
|        |         |
| 160 mm | 1 2705R |



## KNIVES

ERGO™ Retractable Utility Knives



ergo



**KERU01**

|        |       |           |
|--------|-------|-----------|
|        |       |           |
| 170 mm | 26 mm | 5 KERU-01 |

ERGO™ Fixed Utility Knives



ergo



**KEFU01**

|        |       |           |
|--------|-------|-----------|
|        |       |           |
| 170 mm | 26 mm | 5 KEFU-01 |

ERGO™ Snap Off Utility Knives with 18 mm Blades



ergo



**KE18-01**

|        |       |           |
|--------|-------|-----------|
|        |       |           |
| 161 mm | 26 mm | 5 KE18-01 |

Retractable Utility Knives with TPR Grip



**KBRU-01**

|        |       |           |
|--------|-------|-----------|
|        |       |           |
| 170 mm | 26 mm | 5 KBRU-01 |

Retractable Utility Knives



**KGRU-01**

|        |       |           |
|--------|-------|-----------|
|        |       |           |
| 160 mm | 26 mm | 5 KGRU-01 |

Retractable Twist Utility Knives



**KGRU-02**

|        |       |           |
|--------|-------|-----------|
|        |       |           |
| 145 mm | 26 mm | 5 KGRU-02 |

Mini Retractable Utility Knives



**KMU-01**

|       |       |          |
|-------|-------|----------|
|       |       |          |
| 90 mm | 26 mm | 5 KMU-01 |

Squeeze Retractable Utility Knives with Rubber Grip



**SQZ150003**

|        |       |             |
|--------|-------|-------------|
|        |       |             |
| 170 mm | 60 mm | 6 SQZ150003 |

Fixed Utility Knives with TPR grip



**KBFU-01**

|        |       |           |
|--------|-------|-----------|
|        |       |           |
| 170 mm | 26 mm | 5 KBFU-01 |

Fixed Utility Knives



**KGFU-01**

|        |       |           |
|--------|-------|-----------|
|        |       |           |
| 160 mm | 26 mm | 5 KGFU-01 |

Trapezoidal Blades for Utility Knives - 100 Pcs



**KBGU**



0.635 x 19 x 60 mm



1 KBGU-100P

Hook Trapezoidal Blades for Utility Knives - 5 Pcs/Dispenser



**KBGH-5P-DISPEN**



0.635 x 19 x 51 mm



20 KBGH-5P-DISPEN

Snap Off Utility Knives with TPR Grip and 9 mm Blades



**KB09-01**



140 mm



5 KB09-01

Trapezoidal Blades for Utility Knives - 5 Pcs/Dispenser



**KBGU-5P-DISPEN**



0.635 x 19 x 60 mm



20 KBGU-5P-DISPEN

Safety Trapezoidal Blades for Utility Knives - 5 Pcs/Dispenser



**KBGR-5P-DISPEN**



0.635 x 19 x 55 mm



20 KBGR-5P-DISPEN

Snap Off Utility Knives with TPR Grip and 18 mm Blades



**KB18-01**



160 mm



5 KB18-01

Trapezoidal Blades for Utility Knives - 10 Pcs/Dispenser



**KBGU-10P-DISPEN**



0.635 x 19 x 60 mm



20 KBGU-10P-DISPEN

Trapezoidal Hook Blades for SQZ150003 Utility Knives



**SQZ150003-HSBL**



51 mm



6 SQZ150003-HSBL

Snap Off Utility Knives with 9 mm Blades



**KG09-01**



140 mm

140 mm



5 KG09-01

10 KG09-01-3P





Snap Off Utility Knives with 18 mm Blades



**KG18-01**



160 mm



5 KG18-01

Blades for Utility Knives 18 mm - 5 Pcs/  
Dispenser



**KUBG18-5DISPEN**



15 x 30 x 130 mm



20 KUBG18-5DISPEN

Holsters for Fixed Utility Knives



**KHU-01**



90 g



4 KHU-01

Snap Off Blades for Utility Knives 9 mm -  
10 Pcs/Dispenser



**KSBG09-10DISPEN**



1 x 9 x 85 mm



20 KSBG09-10DISPEN

Snap Off Blades for Utility Knives 18 mm -  
10 Pcs/Dispenser



**KSBG18-10DISPEN**



15 x 30 x 130 mm



20 KSBG18-10DISPEN

Mini Squeeze Retractable Utility Knives  
with Rubber Grip



**SQZ-MINI**



160 mm



24 SQZ-MINI

Blades for Utility Knives - 5 Pcs/Retail  
Pack



**KUBG**



0.7 x 85 x 9 mm



20 KUBG09-5P

Auto Retractable Safety Utility Knives



**KGAU-01**



160 mm



5 KGAU-01

Trapezoidal Mini Squeeze Blades for SQZ-  
MINI Utility Knife



**SQZ-MINI-BLADE**



28 mm



1 SQZ-MINI-BLADE

**BAHCO**

Sports Foldable Utility Knives with Aluminium Handle and Twin Blades



**KBTU-01**



5 KBTU-01

Sports Foldable Utility Knives with Polyamide Handle



**KGSU-01**



5 KGSU-01

Multipurpose Tradesman Stainless-Steel Knives with Dual-Component Handle -15 Pcs/Counter Display



**2446-BL**

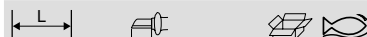

218 mm 102 mm 15 2446-BL

Sports Foldable Knives for Rope Cutting



**KBSK-01**



5 KBSK-01

Tradesman Laplander Knives with Dual-Component Green Handle



**2446-LAP**

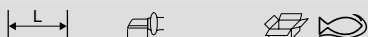

218 mm 102 mm 15 2446-LAP  
218 mm 102 mm 10 SB2446-LAP

SB: Retail packed

Multipurpose Tradesman Knives with Dual-Component Handle and Safety Blunt Tip



**2446-SAFE**

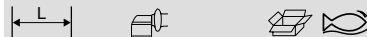

215 mm 95 mm 15 2446-SAFE

Sports Foldable Utility Knives with Aluminium Handle



**KBSU-01**



5 KBSU-01

Multipurpose Tradesman Knives with Dual-Component Handle and Double Button Holster



**2446**

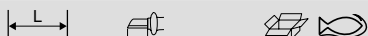

225 mm 100 mm 15 2446

Tradesman Knives for Lino Carpets - 12 Pcs/Counter Display



**2446-LINO**

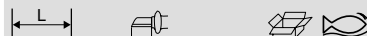

180 mm 55 mm 12 2446-LINO



Electrician Stripping Knives for Both Hands Use



**2446-EL**

|       |        |    |         |
|-------|--------|----|---------|
|       |        |    |         |
| 32 mm | 150 mm | 12 | 2446-EL |

Tradesman Electrician's Stripping Knives for Right Hand Use



**2446-ELR**

|       |        |    |          |
|-------|--------|----|----------|
|       |        |    |          |
| 34 mm | 145 mm | 12 | 2446-ELR |

Multipurpose Tradesman Knives with 1-Component Handle - 15 Pcs/Counter Display



**1446**

|        |        |    |      |
|--------|--------|----|------|
|        |        |    |      |
| 220 mm | 100 mm | 15 | 1446 |

Electrician Stripping Knives for Both Hands Use Retail Pack



**SB2446-EL**

|        |       |    |           |
|--------|-------|----|-----------|
|        |       |    |           |
| 150 mm | 32 mm | 10 | SB2446-EL |

Multipurpose Tradesman Knives with Dual-Component Handle and Special Holster



**2446-OV**

|        |        |    |         |
|--------|--------|----|---------|
|        |        |    |         |
| 220 mm | 100 mm | 15 | 2446-OV |

Multipurpose Tradesman Carbon Steel Knives with Single Component Handle - 15 Pcs/Counter Display



**1446-CS**

|        |        |    |         |
|--------|--------|----|---------|
|        |        |    |         |
| 218 mm | 102 mm | 15 | 1446-CS |

Tradesman Electrician's Stripping Knives for Left Hand Use



**2446-ELL**

|       |        |    |          |
|-------|--------|----|----------|
|       |        |    |          |
| 34 mm | 145 mm | 12 | 2446-ELL |

Tradesman Electrician's Knives with Guide



**2446-EL-HELP**

|       |  |    |              |
|-------|--|----|--------------|
|       |  |    |              |
| 43 mm |  | 12 | 2446-EL-HELP |

Rescue floating knife with fluorescent handle with holster



**1446-FLOAT**

|        |        |    |            |
|--------|--------|----|------------|
|        |        |    |            |
| 226 mm | 102 mm | 15 | 1446-FLOAT |

Floating Knife with fluorescent handle



**1446-FLOAT-B**



225 mm 100 mm 12 1446-FLOAT-B

Without holster

Bucket for 1446 Knives



**BUCKET 1446**



25 l 75 BUCKET 1446

BUCKET - EMPTY

1446x 75 

Empty bucket



**BUCKET-EMPTY**



25 l 6 BUCKET - EMPTY

Bucket for 1446-CS Knives



**BUCKET-1446-CS**



25 l 1 BUCKET - 1446-CS

BUCKET - EMPTY

1446-CSx 75 

Bucket for 1446-FLOAT Knives



**BUCKET-1446-FLOAT**



25 l 1 BUCKET-1446-FLOAT

BUCKET - EMPTY

1446-FLOATx 75 

Multipurpose Tradesman Knives with 1-Component Handle and Special Holster



**1446-OV**



225 mm 100 mm 15 1446-OV

Electricians Pinch Knives with Wooden Handle



**2820EK-01**



25 mm 130 mm 12 2820EK-01

Electricians Knives with 70 mm Serrated Blades



**2820EK**



95 mm 205 mm 6 2820EK

Electricians Folding Knives with 60 mm Blades



**2820EF1**



90 mm 200 mm 12 2820EF1



Electricians Folding Knives with 65 mm Blades



**2820EF2**

|       |        |   |         |
|-------|--------|---|---------|
|       |        |   |         |
| 85 mm | 195 mm | 8 | 2820EF2 |

18-in-1 Aluminium Foldable Multitools



**MTT151**

|        |   |        |
|--------|---|--------|
|        |   |        |
| 150 mm | 6 | MTT151 |

Windows Scraper with Interchangeable Blade



**KRSS-01**

|      |    |         |
|------|----|---------|
|      |    |         |
| 80 g | 10 | KRSS-01 |

Electricians Folding Knives with 70 mm Blades



**2820EF3**

|       |        |   |         |
|-------|--------|---|---------|
|       |        |   |         |
| 80 mm | 170 mm | 1 | 2820EF3 |

18-in-1 Aluminium Mini Foldable Multitools



**MTT121**

|        |   |        |
|--------|---|--------|
|        |   |        |
| 110 mm | 8 | MTT121 |

Windows Scrapers with Dual-Component Plastic Body



**KBWS-01**

|      |    |         |
|------|----|---------|
|      |    |         |
| 70 g | 10 | KBWS-01 |

Electricians Folding Knives with 70/85 mm Double Blades



**2820EF4**

|          |        |   |         |
|----------|--------|---|---------|
|          |        |   |         |
| 75-85 mm | 170 mm | 1 | 2820EF4 |

12-in-1 Aluminium Foldable Multitools



**MTT051**

|        |   |        |
|--------|---|--------|
|        |   |        |
| 165 mm | 6 | MTT051 |





## Clamps & Vices



## CLAMPS

### Quick Clamps with 200 kg Force



#### QCB

| L       | QCB        |
|---------|------------|
| 456 mm  | 6 QCB-150  |
| 606 mm  | 6 QCB-300  |
| 756 mm  | 6 QCB-450  |
| 906 mm  | 4 QCB-600  |
| 1206 mm | 4 QCB-900  |
| 1556 mm | 8 QCB-1250 |

### Quick Clamps with 125 kg Force



#### QCG

| L      | QCG       |
|--------|-----------|
| 380 mm | 6 QCG-150 |
| 530 mm | 6 QCG-300 |

### High Resistance Quick Clamps with 70 kg Maximum Force



#### QC

| X | L      | QC           |
|---|--------|--------------|
| 1 | 230 mm | 12 QC-115A   |
| 2 | 230 mm | 6 QC-115A-2P |
| 1 | 305 mm | 6 QC-150A    |
| 2 | 305 mm | 6 QC-150A-2P |
| 1 | 475 mm | 6 QC-300A    |
| 2 | 475 mm | 4 QC-300A-2P |

-2P: Twin Pack

### F-Clamps with Steel T-Handle 90 mm



#### 3066

| L      | T-Handle | 3066        |
|--------|----------|-------------|
| 250 mm | 90 mm    | 5 306601500 |
| 300 mm | 90 mm    | 5 306602000 |
| 400 mm | 90 mm    | 5 306603000 |
| 510 mm | 90 mm    | 5 306604000 |

### F-Clamps with Steel T-Handle 120 mm



#### 3067

| L       | T-Handle | 3067        |
|---------|----------|-------------|
| 415 mm  | 125 mm   | 5 306703000 |
| 510 mm  | 125 mm   | 5 306704000 |
| 610 mm  | 125 mm   | 5 306705000 |
| 710 mm  | 125 mm   | 5 306706000 |
| 910 mm  | 125 mm   | 5 306708000 |
| 1115 mm | 125 mm   | 5 306710000 |
| 1310 mm | 125 mm   | 2 306712000 |
| 1610 mm | 125 mm   | 2 306715000 |

### F-Clamps with Steel T-Handle 150 mm



#### 3068

| L       | T-Handle | 3068        |
|---------|----------|-------------|
| 430 mm  | 155 mm   | 5 306803000 |
| 535 mm  | 155 mm   | 5 306804000 |
| 640 mm  | 155 mm   | 2 306805000 |
| 730 mm  | 155 mm   | 2 306806000 |
| 820 mm  | 155 mm   | 2 306808000 |
| 1135 mm | 155 mm   | 2 306810000 |
| 1335 mm | 155 mm   | 2 306812000 |
| 1630 mm | 155 mm   | 1 306815000 |
| 2130 mm | 155 mm   | 1 306820000 |

### F-Clamps with Steel T-Handle 220 mm



#### 3069

| L       | T-Handle | 3069        |
|---------|----------|-------------|
| 430 mm  | 225 mm   | 2 306903000 |
| 540 mm  | 225 mm   | 2 306904000 |
| 638 mm  | 225 mm   | 2 306905000 |
| 730 mm  | 225 mm   | 2 306906000 |
| 932 mm  | 225 mm   | 2 306908000 |
| 1130 mm | 225 mm   | 2 306910000 |

### F-Clamps with Rubberised Handle



#### 420SH

| L       | T-Handle | 420SH            |
|---------|----------|------------------|
| 100 mm  | 50 mm    | 10 420SH-50-100  |
| 200 mm  | 50 mm    | 10 420SH-50-200  |
| 120 mm  | 60 mm    | 12 420SH-60-120  |
| 300 mm  | 60 mm    | 12 420SH-60-300  |
| 160 mm  | 80 mm    | 12 420SH-80-160  |
| 200 mm  | 100 mm   | 10 420SH-100-200 |
| 250 mm  | 120 mm   | 8 420SH-120-250  |
| 300 mm  | 120 mm   | 8 420SH-120-300  |
| 400 mm  | 120 mm   | 6 420SH-120-400  |
| 500 mm  | 120 mm   | 6 420SH-120-500  |
| 600 mm  | 120 mm   | 6 420SH-120-600  |
| 800 mm  | 120 mm   | 6 420SH-120-800  |
| 1000 mm | 120 mm   | 6 420SH-120-1000 |
| 1250 mm | 120 mm   | 6 420SH-120-1250 |
| 1500 mm | 120 mm   | 6 420SH-120-1500 |
| 400 mm  | 140 mm   | 6 420SH-140-400  |
| 400 mm  | 175 mm   | 6 420SH-175-400  |

Handy Spring Clamps with Movable Gripping Surface



**420SC**

|       | g     |    |          |
|-------|-------|----|----------|
| 25 mm | 60 g  | 10 | 420SC-25 |
| 50 mm | 120 g | 5  | 420SC-50 |

Heavy Duty Round Guide Bench Vices with Interchangeable Jaws, Suitable for Swivel Base



**6010**

| 80 mm  | 1 | 601000800 |
|--------|---|-----------|
| 100 mm | 1 | 601001000 |
| 125 mm | 1 | 601001250 |
| 150 mm | 1 | 601001500 |

Pair of Spare Pipe Jaw Set for 834V-4, 834V-7 & 6072 Bench Vices



**833P**

| 100 mm       | 1 | 833PJ-4  |
|--------------|---|----------|
| 125 mm       | 1 | 833PJ-5  |
| 150 / 175 mm | 1 | 833PJ-67 |

**BENCH VICES**

Heavy Duty Square Guide Bench Vices with Interchangeable Jaws



**834V**

| 100 mm | 1 | 834V-4 |
|--------|---|--------|
| 125 mm | 1 | 834V-5 |
| 150 mm | 1 | 834V-6 |
| 175 mm | 1 | 834V-7 |

Slide adjustment screw to regulate the looseness with pipe holding jaws

Round Guide Portable Bench Vices with Interchangeable Jaws



**834V-2**

| 63 mm | 1 | 834V-2 |
|-------|---|--------|

Spare Spindles and Nuts for 6072 and 834V Bench Vices



**6070H**

| 100 mm | 1 | 6070H1000 |
|--------|---|-----------|
| 125 mm | 1 | 6070H1250 |
| 150 mm | 1 | 6070H1500 |
| 175 mm | 1 | 6070H1750 |

Heavy Duty Square Guide Bench Vices with Interchangeable Jaws, Suitable for Swivel Base



**6072**

| 100 mm | 1 | 607201000 |
|--------|---|-----------|
| 125 mm | 1 | 607201250 |
| 150 mm | 1 | 607201500 |
| 175 mm | 1 | 607201750 |

Pair of Spare Jaws and Screws for 6072 and 834V Bench Vices



**6072M**

| 100 mm | 834V-4, 607201000 | 1 | 6072M1000 |
|--------|-------------------|---|-----------|
| 150 mm | 834V-6, 607201500 | 1 | 6072M1500 |
| 175 mm | 834V-7, 607201750 | 1 | 6072M1750 |

125 mm size jaw common for round & square models

Pair of Spare Jaws and Screws for 6010 Bench Vice



**6010M**

| 80 mm  | 601000800                    | 1 | 6010M0800 |
|--------|------------------------------|---|-----------|
| 100 mm | 601001000                    | 1 | 6010M1000 |
| 125 mm | 834V-5, 607201250, 601001250 | 1 | 6010M1250 |
| 150 mm | 601001500                    | 1 | 6010M1500 |



125 mm size jaw common for round & square models



Spare Spindles and Bolts for 6010 Bench Vice





### 6010H

|  |  |           |
|--|---|-----------|
| 80 mm  | 1   | 6010H0800 |
| 100 mm   | 1   | 6010H1000 |
| 125 mm   | 1   | 6010H1250 |
| 150 mm   | 1   | 6010H1500 |

Pair of Spare Aluminium Jaws with magnetic strip



### 833AJ

|  |  |         |
|---|---|---------|
| 100 mm  | 1   | 833AJ-4 |
| 125 mm  | 1   | 833AJ-5 |
| 150 mm  | 1   | 833AJ-6 |

Pair of Spare Jaws for 834V-2 Table Vice





### 6040M/H

|  |  |           |
|--|---|-----------|
| 63 mm  | 1   | 6040M0630 |

Pair of Spare Polyurethane Jaws with magnetic strip



### 833FJ



|  |  |         |
|---|---|---------|
| 100 mm  | 1   | 833FJ-4 |
| 125 mm  | 1   | 833FJ-5 |
| 150 mm  | 1   | 833FJ-6 |

## BENCH VICE ACCESSORIES

Swivel Bases for 6010/6072 and 834V Bench Vices



### 833SB

|  |  |  |         |
|--|---|---|---------|
| 80 mm  | 100 mm  | 1   | 833SB-4 |
| 100 mm   | 125 mm  | 1   | 833SB-5 |
| 125 mm   | 150 mm  | 1   | 833SB-6 |
| 150 mm   | 175 mm  | 1   | 833SB-7 |



# Hammers







## CLAW HAMMERS



ERGO™ Claw Hammers with Rubber Grip 



|            |   |   |   |
|------------|---|---|---|
| <b>529</b> |  |  |  |
| 450 g      | 4   | 529-16-L  |   |
| 450 g      | 4   | 529-16-XL   |   |
| 570 g      | 4   | 529-20-L  |   |
| 570 g      | 4   | 529-20-XL   |   |



ERGO™ Straight Claw Hammers with Bi-Material Rubber Grip 



|             |   |   |   |
|-------------|---|---|---|
| <b>529S</b> |  |  |  |
| 450 g       | 4   | 529S-16-XL  |   |
| 570 g       | 4   | 529S-20-XL  |   |

Claw Hammers with Rubber Grip Steel Tube Handle 



|            |   |   |   |
|------------|---|---|---|
| <b>429</b> |  |  |  |
| 230 g      | 4   | 429-8   |   |
| 370 g      | 4   | 429-13  |   |
| 450 g      | 4   | 429-16  |   |
| 570 g      | 4   | 429-20  |   |



Claw Hammers with Rubber Grip Fibreglass Handle 



|            |   |   |   |
|------------|---|---|---|
| <b>428</b> |  |  |  |
| 450 g      | 4   | 428-16  |   |



Claw Hammer rubber grip with curved nails 



|             |   |   |   |
|-------------|---|---|---|
| <b>428F</b> |  |  |  |
| 230 g       | 4   | 428F-8  |   |
| 370 g       | 4   | 428F-13   |   |
| 454 g       | 4   | 428F-16   |   |
| 567 g       | 4   | 428F-20   |   |
| 680 g       | 4   | 428F-24   |   |



Claw Hammer rubber grip with RIP nails 



|             |   |   |   |
|-------------|---|---|---|
| <b>428S</b> |  |  |  |
| 454 g       | 4   | 428S-16   |   |
| 567 g       | 4   | 428S-20   |   |



Claw Hammers with Anti-Slip Surface Wooden Handle 



|            |   |   |   |
|------------|---|---|---|
| <b>427</b> |  |  |  |
| 370 g      | 4   | 427-13  |   |
| 680 g      | 4   | 427-24  |   |
| 230 g      | 4   | 427-8   |   |
| 450 g      | 4   | 427-16  |   |
| 570 g      | 4   | 427-20  |   |

Claw Hammer with RIP nails and polish head 



|             |   |   |   |
|-------------|---|---|---|
| <b>427S</b> |  |  |  |
| 454 g       | 4   | 427S-16   |   |
| 567 g       | 4   | 427S-20   |   |

Spanish Style Claw Hammers with Dotted Grip Hickory Handle 



|            |   |   |   |
|------------|---|---|---|
| <b>427</b> |  |  |  |
| 700 g      | 6   | 427-700   |   |

Spanish Style Claw Hammers with Rubber Grip Tri-Material Handle



**428**

|       |   |         |
|-------|---|---------|
|       |   |         |
| 700 g | 6 | 428-700 |

**NAIL PULLERS**

Compact Nail Pullers with Thermoplastic Handle



**36**

|        |   |    |
|--------|---|----|
|        |   |    |
| 220 mm | 5 | 36 |

**ENGINEERING HAMMERS**

Ball Pein Hammers with Hickory Handle



**479**

|       |   |        |
|-------|---|--------|
|       |   |        |
| 230 g | 6 | 479-08 |
| 340 g | 6 | 479-12 |
| 450 g | 6 | 479-16 |
| 570 g | 6 | 479-20 |
| 800 g | 6 | 479-24 |
| 900 g | 6 | 479-32 |

Ball Pein hammer with fiberglass Handle



**479F**

|       |   |         |
|-------|---|---------|
|       |   |         |
| 230 g | 6 | 479F-08 |
| 340 g | 6 | 479F-12 |
| 450 g | 6 | 479F-16 |
| 570 g | 6 | 479F-20 |
| 680 g | 6 | 479F-24 |
| 900 g | 6 | 479F-32 |

German DIN Locksmith's Hammers



**481**

|        |   |          |
|--------|---|----------|
|        |   |          |
| 100 g  | 6 | 481-100  |
| 200 g  | 6 | 481-200  |
| 300 g  | 6 | 481-300  |
| 400 g  | 6 | 481-400  |
| 500 g  | 6 | 481-500  |
| 800 g  | 6 | 481-800  |
| 1000 g | 6 | 481-1000 |
| 1500 g | 6 | 481-1500 |
| 2000 g | 6 | 481-2000 |

German DIN Hammer Fiberglass Handle



**481F**

|       |   |          |
|-------|---|----------|
|       |   |          |
| 100 g | 6 | 481F-100 |
| 200 g | 4 | 481F-200 |

|        |   |           |
|--------|---|-----------|
|        |   |           |
| 300 g  | 6 | 481F-300  |
| 400 g  | 6 | 481F-400  |
| 500 g  | 6 | 481F-500  |
| 800 g  | 6 | 481F-800  |
| 1000 g | 6 | 481F-1000 |
| 1500 g | 4 | 481F-1500 |
| 2000 g | 4 | 481F-2000 |

Rivoir Hammers French Pattern with Anti-Sliding Handle



**482**

|        |   |        |
|--------|---|--------|
|        |   |        |
| 300 g  | 6 | 482-25 |
| 400 g  | 6 | 482-28 |
| 500 g  | 6 | 482-30 |
| 800 g  | 6 | 482-35 |
| 1000 g | 6 | 482-40 |
| 1500 g | 6 | 482-45 |

Rivoir Hammer Fiberglass Handle



**482F**

|        |   |         |
|--------|---|---------|
|        |   |         |
| 300 g  | 4 | 482F-25 |
| 400 g  | 4 | 482F-28 |
| 470 g  | 6 | 482F-30 |
| 800 g  | 4 | 482F-35 |
| 1000 g | 2 | 482F-40 |
| 1500 g | 4 | 482F-45 |



Warrington Hammers English Joiner's with Cross Pein



**480**

|       |   |        |
|-------|---|--------|
|       |   |        |
| 230 g | 4 | 480-08 |
| 280 g | 6 | 480-10 |
| 340 g | 6 | 480-12 |
| 400 g | 4 | 480-14 |
| 570 g | 4 | 480-20 |

Carpenter Hammers Spike Claw with Forged Head



**485W**

|       |   |                |
|-------|---|----------------|
|       |   |                |
| 650 g | 6 | 485W-650       |
| 750 g | 6 | 485W-750       |
|       | 1 | SH-485W        |
|       | 1 | SH-485W-PLATES |

Cross Pein Pin Hammers with Hickory Handle



**490**

|       |   |         |
|-------|---|---------|
|       |   |         |
| 100 g | 4 | 490-3.5 |

Pattern Makers Hammers with Ball Pein and Hickory Handle



**492**

|       |   |         |
|-------|---|---------|
|       |   |         |
| 100 g | 6 | 492-3.5 |

Joiner's Hammers French Pattern



**483**

|       |   |        |
|-------|---|--------|
|       |   |        |
| 100 g | 6 | 483-16 |
| 160 g | 6 | 483-20 |
| 200 g | 6 | 483-22 |
| 300 g | 6 | 483-25 |
| 400 g | 6 | 483-28 |

Club Hammers with Hickory Handle



**484**

|        |   |          |
|--------|---|----------|
|        |   |          |
| 1000 g | 6 | 484-1000 |
| 1250 g | 6 | 484-1250 |
| 1500 g | 6 | 484-1500 |
| 2000 g | 4 | 484-2000 |

**CONSTRUCTION HAMMERS**

Carpenter Hammers Spike Claw with Tubular Steel Shaft



**485**

|       |   |     |
|-------|---|-----|
|       |   |     |
| 600 g | 6 | 485 |

Joiner Hammer Fiberglass Handle



**483F**

|       |   |         |
|-------|---|---------|
|       |   |         |
| 100 g | 6 | 483F-16 |
| 160 g | 6 | 483F-20 |
| 200 g | 6 | 483F-22 |
| 300 g | 6 | 483F-25 |
| 400 g | 6 | 483F-28 |
| 500 g | 4 | 483F-30 |

Club Hammer Fiberglass Handle



**484F**

|        |   |           |
|--------|---|-----------|
|        |   |           |
| 1000 g | 6 | 484F-1000 |
| 1250 g | 6 | 484F-1250 |
| 1500 g | 6 | 484F-1500 |
| 2000 g | 4 | 484F-2000 |

Club Hammers Spanish Type with Oval Eye



**407**

|        |   |          |
|--------|---|----------|
|        |   |          |
| 700 g  | 5 | 407-700  |
| 1000 g | 6 | 407-1000 |
| 1400 g | 6 | 407-1400 |

Square Head Sledge Hammers with Tri-Material Handle



**488F**

|        |   |           |
|--------|---|-----------|
|        |   |           |
| 2000 g | 2 | 488F-2000 |
| 3000 g | 2 | 488F-3000 |
| 4000 g | 2 | 488F-4000 |
| 5000 g | 4 | 488F-5000 |
| 6000 g | 2 | 488F-6000 |

Spanish Type Bricklayer's Hammers with Fibreglass Handle



**486F**

|       |   |          |
|-------|---|----------|
|       |   |          |
| 700 g | 6 | 486F-700 |

Club Hammers with Fibreglass Handle



**407F**

|        |   |           |
|--------|---|-----------|
|        |   |           |
| 700 g  | 6 | 407F-700  |
| 1000 g | 6 | 407F-1000 |
| 1400 g | 6 | 407F-1400 |

Bricklayer's Hammers with Hickory Handle



**486W**

|       |   |          |
|-------|---|----------|
|       |   |          |
| 500 g | 4 | 486W-500 |
| 600 g | 4 | 486W-600 |
|       | 1 | SH-486W  |

Bricklayer's Hammers with Rubber Grip



**486**

|       |   |     |
|-------|---|-----|
|       |   |     |
| 600 g | 4 | 486 |

Square Head Sledge Hammers with Hickory Handle



**488**

|        |   |          |
|--------|---|----------|
|        |   |          |
| 2000 g | 2 | 488-2000 |
| 3000 g | 2 | 488-3000 |
| 4000 g | 2 | 488-4000 |
| 5000 g | 2 | 488-5000 |
| 6000 g | 1 | 488-6000 |

Spanish Type Bricklayer's Hammers with Hickory Handle



**486-700**

|       |   |         |
|-------|---|---------|
|       |   |         |
| 700 g | 6 | 486-700 |

Mason's Pin with Pointed Tip



**4401**

|        |    |           |
|--------|----|-----------|
|        |    |           |
| 255 mm | 10 | 440102500 |
| 300 mm | 10 | 440103000 |



Spare Wooden Handles for Hammers



**WSH**



|   |    |                |
|---|----|----------------|
| 407   | 1  | SH-407         |
| 491-3000 & 491-4000                         | 12 | SH-491-34      |
| 491-5000 & 491-6000                         | 12 | SH-491-56      |
| 488-2000                                    | 10 | SH-488-2000    |
| 488-3000, 488-4000                          | 10 | SH-488-34      |
| 488-5000, 488-6000                          | 10 | SH-488-56      |
| 427-700                                     | 10 | SH-427-700     |
| 486-700, 495-500, 495-600, 493-500, 493-600 | 10 | SH-486-493-495 |

Spanish Type Shovel-Hatchets with Fibreglass Handle



**493F**



|       |   |          |
|-------|---|----------|
| 500 g | 6 | 493F-500 |
| 600 g | 1 | 493F-600 |

Plasterer's Hatchets with Tubular Steel Shaft



**494**



|       |   |         |
|-------|---|---------|
| 600 g | 4 | 494-600 |
|-------|---|---------|

Fibreglass Spare Handles



**FSH**



|  |    |                 |
|--|----|-----------------|
| 488f-2000  | 10 | SH-488F-2000    |
| 488F-3000 & 488F-4000                            | 1  | SH-488F-34      |
| 488F-5000 & 488F-6000                            | 1  | SH-488F-56      |
| 428-700  | 10 | SH-428-700      |
| 486F-700, 495F-500, 495F-600, 493F-500, 493F-600 | 10 | SH-486F493F495F |

Spanish Type Shovel-Picks with Hickory Handle



**495**



|       |   |         |
|-------|---|---------|
| 500 g | 6 | 495-500 |
| 600 g | 6 | 495-600 |

Anti Rebound Hammers with Wooden Handle



**3625AR**



|        |    |           |
|--------|----|-----------|
| 550 g  | 34 | 3625AR-35 |
| 1430 g | 18 | 3625AR-50 |
| 1550 g | 12 | 3625AR-60 |

**SPECIALTY HAMMERS**

Spanish Type Shovel-Hatchets with Wooden Handle



**493**



|       |   |         |
|-------|---|---------|
| 500 g | 6 | 493-500 |
| 600 g | 6 | 493-600 |

Spanish Type Shovel-Picks with Fibreglass Handle



**495F**



|       |   |          |
|-------|---|----------|
| 500 g | 6 | 495F-500 |
| 600 g | 1 | 495F-600 |

Spare Tips for 3625AR Hammers



**3625ARL**



|       |           |   |            |
|-------|-----------|---|------------|
| 35 mm | 3625AR-35 | 6 | 3625ARL-35 |
| 50 mm | 3625AR-50 | 6 | 3625ARL-50 |
| 60 mm | 3625AR-60 | 6 | 3625ARL-60 |



Spare Handle for 3625AR Hammers



**3625ARLH**

| Part      | Length | Weight | Part        |
|-----------|--------|--------|-------------|
| 3625AR-35 | 290 mm | 80     | 3625ARLH-35 |
| 3625AR-60 | 300 mm | 50     | 3625ARLH-50 |
| 3625AR-60 | 390 mm | 16     | 3625ARLH-60 |

Pein Sledge Hammers with Hickory Handle



**491**

| Weight | Quantity | Part     |
|--------|----------|----------|
| 3000 g | 4        | 491-3000 |
| 4000 g | 4        | 491-4000 |
| 5000 g | 4        | 491-5000 |
| 6000 g | 4        | 491-6000 |

**SOFT FACE HAMMERS & MALLETS**

Thermoplastic Polyurithane Hammers



**3625Y**

| Weight | Quantity | Part     |
|--------|----------|----------|
| 120 g  | 6        | 3625Y-22 |
| 225 g  | 6        | 3625Y-32 |
| 372 g  | 6        | 3625Y-40 |
| 484 g  | 6        | 3625Y-50 |

Dead Blow Sledge Hammers with Anti-Sliding Handle



**3625PU**

| Weight | Quantity | Part      |
|--------|----------|-----------|
| 300 g  | 12       | 3625PU-30 |
| 790 g  | 6        | 3625PU-50 |
| 1080 g | 6        | 3625PU-60 |

99/105 mm Safety Sledge Hammers with Rubber Handle



**489-1100/489-1800**

| Weight | Quantity | Part     |
|--------|----------|----------|
| 1100 g | 8        | 489-1100 |
| 1800 g | 8        | 489-1800 |

Polyflex Plastic Hammers



**3625YL**

| Part     | Weight | Quantity | Part      |
|----------|--------|----------|-----------|
| 3625Y-22 | 22 mm  | 20       | 3625YL-22 |
| 3625Y-32 | 32 mm  | 20       | 3625YL-32 |
| 3625Y-40 | 40 mm  | 20       | 3625YL-40 |
| 3625Y-50 | 50 mm  | 20       | 3625YL-50 |

Dead Blow Sledge Hammers with Anti-Sliding Handle 105 mm



**3625PU-105**

| Weight | Weight | Quantity | Part       |
|--------|--------|----------|------------|
| 5000 g | 5600 g | 4        | 3625PU-105 |

150/190 mm Safety Sledge Hammers with Rubber Handle



**489-2700/489-5400**

| Weight | Quantity | Part     |
|--------|----------|----------|
| 2700 g | 4        | 489-2700 |
| 3600 g | 4        | 489-3600 |
| 4500 g | 4        | 489-4500 |
| 5400 g | 4        | 489-5400 |

Superflex Plastic Hammers with Wooden Handle



**3625N**

| Weight | Quantity | Part     |
|--------|----------|----------|
| 120 g  | 6        | 3625N-22 |
| 225 g  | 6        | 3625N-32 |
| 372 g  | 6        | 3625N-40 |
| 484 g  | 6        | 3625N-50 |



Pairs of Poll for 3625N Superflex Plastic Hammers



**3625NL**

| 3625N-22 | 22 mm | 20 | 3625NL-22 |  |
|----------|-------|----|-----------|--|
| 3625N-32 | 32 mm | 20 | 3625NL-32 |  |
| 3625N-40 | 40 mm | 20 | 3625NL-40 |  |
| 3625N-50 | 50 mm | 20 | 3625NL-50 |  |

Spare Handle for 3625W Hammers



**3625WLH**

| 3625W-22 | 50 | 3625WLH-22 |  |
|----------|----|------------|--|
| 3625W-28 | 50 | 3625WLH-28 |  |
| 3625W-35 | 80 | 3625WLH-35 |  |
| 3625W-44 | 50 | 3625WLH-44 |  |
| 3625W-55 | 16 | 3625WLH-55 |  |

Rubber Mallets with Wooden Handle



**3625RM**

| 290 g | 50 | 3625RM-55 |
|-------|----|-----------|
| 460 g | 40 | 3625RM-65 |
| 660 g | 30 | 3625RM-75 |
| 850 g | 20 | 3625RM-90 |

Nylon Tip Mallets with Wooden Handle



**3625W**

| 150 g  | 120 | 3625W-22 |
|--------|-----|----------|
| 250 g  | 1   | 3625W-28 |
| 490 g  | 1   | 3625W-35 |
| 1050 g | 1   | 3625W-44 |
| 1470 g | 12  | 3625W-55 |

Nylon Tip Mallets with Rubber Grip



**3625S**

| 350 g  | 50 | 3625S-28 |
|--------|----|----------|
| 610 g  | 30 | 3625S-35 |
| 1100 g | 18 | 3625S-44 |

Copper Sledge Hammers with Soft Face



**4130**

| 500 g  | 12 | 413005000 |
|--------|----|-----------|
| 1000 g | 12 | 413010000 |
| 1500 g | 12 | 413015000 |
| 2000 g | 6  | 413020000 |
| 3000 g | 1  | 413030000 |
| 4000 g | 1  | 413040000 |

Pairs of Poll for 3625W and 3625S Nylon Tipped Mallets



**3625WL**

| 3625W-22           | 22 mm | 10 | 3625WL-22 |  |
|--------------------|-------|----|-----------|--|
| 3625W-28, 3625S-28 | 28 mm | 10 | 3625WL-28 |  |
| 3625W-35, 3625S-35 | 35 mm | 10 | 3625WL-35 |  |
| 3625W-44, 3625S-44 | 44 mm | 10 | 3625WL-44 |  |
| 3625W-55           | 55 mm | 6  | 3625WL-55 |  |



## Tree Felling & Forestry Tools



## AXES, HATCHETS & MAULS

Camping Axes with Curved Ash Wood Handle and Yankee Pattern 380 mm-500 mm



### HUS

| Length | Weight (g) | Quantity | Model       |
|--------|------------|----------|-------------|
| 380 mm | 770 g      | 4        | HUS-0.6-380 |
| 500 mm | 1080 g     | 4        | HUS-0.8-500 |

Camping Axes with Curved Ash Wood Handle



### HGPS

| Length | Weight (g) | Quantity | Model           |
|--------|------------|----------|-----------------|
| 380 mm | 944 g      | 4        | HGPS-0.8-380-WB |
| 400 mm | 1130 g     | 4        | HGPS-1.0-400-WB |
| 360 mm | 790 g      | 10       | HGPS-0.6-360    |
| 380 mm | 1020 g     | 4        | HGPS-0.8-380    |
| 400 mm | 1260 g     | 4        | HGPS-1.0-400    |

Camping Axes with Curved Ash Wood Handle and Yankee Pattern 650 mm



### HUS-1.0-650

| Length | Weight (g) | Quantity | Model       |
|--------|------------|----------|-------------|
| 650 mm | 1380 g     | 4        | HUS-1.0-650 |

Camping Axes with Fibreglass Handle and French Pattern Blade



### HFGPS

| Length | Weight (g) | Quantity | Model           |
|--------|------------|----------|-----------------|
| 380 mm | 1010 g     | 4        | HFGPS-0,7-400FG |

Felling Axes with Curved Ash Wood Handle 800 mm



### FGS-810

| Length | Weight (g) | Quantity | Model       |
|--------|------------|----------|-------------|
| 800 mm | 2260 g     | 4        | FGS-1.6-810 |
| 800 mm | 2460 g     | 4        | FGS-1.8-810 |

Felling Axes with Hickory Wood Handle and Canadian Style



### FCP

| Length | Weight (g) | Quantity | Model       |
|--------|------------|----------|-------------|
| 800 mm | 2500 g     | 4        | FCP-1.8-810 |
| 850 mm | 3000 g     | 2        | FCP-2.3-860 |

Felling Axes with Curved Ash Wood Handle 600 mm-700 mm



### FGS

| Length | Weight (g) | Quantity | Model           |
|--------|------------|----------|-----------------|
| 700 mm | 1730 g     | 4        | FGS-1.25-700-WB |
| 810 mm | 2210 g     | 4        | FGS-1.6-810-WB  |
| 600 mm | 1400 g     | 4        | FGS-1.0-600     |
| 700 mm | 1850 g     | 4        | FGS-1.25-700    |

Felling Axes with Fibreglass Handle and French Style



### FFSS

| Length | Weight (g) | Quantity | Model          |
|--------|------------|----------|----------------|
| 900 mm | 2400 g     | 4        | FFSS-1.5-900FG |

Splitting Axes with Curved Ash Wood Handle



### SUS

| Length | Weight (g) | Quantity | Model       |
|--------|------------|----------|-------------|
| 800 mm | 2600 g     | 4        | SUS-2.0-800 |

Splitting Axes with Hickory Wood Handle



### MCP

| Length | Weight (g) | Quantity | Model       |
|--------|------------|----------|-------------|
| 800 mm | 3280 g     | 2        | MCP-2.5-810 |

Mauls/Sledges with Ash Wood/3-Component Handle and Two Flat Face



### LS-MASSE

| Length | Weight (g) | Quantity | Model        |
|--------|------------|----------|--------------|
| 900 mm | 4800 g     | 2        | LS-MASSE-4FG |
| 900 mm | 4640 g     | 2        | LS-MASSE-4   |

Mauls/Sledges with 3-Component Handle and One Flat Face



**LS-MASSE-TR**

| Length | Weight (g) | Quantity | Product Code    |
|--------|------------|----------|-----------------|
| 900 mm | 4840 g     | 2        | LS-MASSE-TR-4FG |

Splitting Axes with Ash Wood/3-Component Handle



**MES**

| Length | Weight (g) | Quantity | Product Code  |
|--------|------------|----------|---------------|
| 900 mm | 4250 g     | 2        | MES-3.5-900   |
| 900 mm | 4310 g     | 2        | MES-3.5-900FG |

Spare Ash Wood Handles for Pick Axes



**SH**

| Length | Quantity | Product Code   |
|--------|----------|----------------|
| 800 mm | 1        | SH-FCS-810     |
| 900 mm | 1        | SH-FCS-860     |
| 600 mm | 1        | SH-FGS-600     |
| 700 mm | 12       | SH-FGS-700     |
| 800 mm | 1        | SH-FGS-800     |
| 900 mm | 1        | SH-FGS-1.8-810 |
| 375 mm | 1        | SH-HFGPS-400FG |
| 400 mm | 1        | SH-HGPS-400    |
| 900 mm | 12       | SH-MES-F-900   |
| 360 mm | 12       | SH-HGPS-360    |
| 380 mm | 1        | SH-HGPS-380    |
| 380 mm | 1        | SH-HUS-380     |
| 500 mm | 1        | SH-HUS-500     |
| 650 mm | 1        | SH-HUS-650     |
| 900 mm | 12       | SH-MES-900     |
| 915 mm | 12       | SH-MES-900FG   |
| 800 mm | 12       | SH-SUS-800     |
| 800 mm | 1        | SH-MCS-800     |
| 905 mm | 1        | SH-FCP-860     |

Pick Axes with Fibreglass Handle for Construction Work



**PAGS-2.0-900FG**

| Length | Weight (g) | Quantity | Product Code   |
|--------|------------|----------|----------------|
| 900 mm | 3000 g     | 1        | PAGS-2.0-900FG |

Pick Axes Heads with Round Eye for Construction Work



**PAGS**

| Length | Weight (g) | Quantity | Product Code |
|--------|------------|----------|--------------|
| 450 mm | 2000 g     | 1        | PAGS-2.0     |

Splitting Axes with Ash Wood/3-Component Handle and One Flat Face



**LS/MES**

| Length | Weight (g) | Quantity | Product Code    |
|--------|------------|----------|-----------------|
| 900 mm | 3390 g     | 2        | LS-MERLIN-2.5   |
| 900 mm | 3330 g     | 2        | LS-MERLIN-2.5FG |
| 900 mm | 3580 g     | 2        | MES-3.0-900     |

Ash Wood/Fibreglass Spare Handles for Pick Axes with Round Eye



**SH-PAGS**

| Length | Weight (g) | Quantity | Product Code  |
|--------|------------|----------|---------------|
| 900 mm | 690 g      | 1        | SH-PAGS-900   |
| 920 mm | 1030 g     | 1        | SH-PAGS-900FG |

**WEDGES**

Synthetic Felling Wedges



**LS-COIN**

| Length | Weight (g) | Quantity | Product Code  |
|--------|------------|----------|---------------|
| 260 mm | 295 g      | 2        | LS-COIN 26 CM |
| 190 mm | 170 g      | 4        | LS-COIN 19 CM |

Twisted Steel Splitting Wedges



**WT**

| Length | Weight (g) | Quantity | Product Code |
|--------|------------|----------|--------------|
| 220 mm | 2000 g     | 4        | W-T-2.0      |

Traditional Steel Splitting Wedges



**WS**

| Length | Weight (g) | Quantity | Product Code |
|--------|------------|----------|--------------|
| 220 mm | 1500 g     | 4        | W-S-1.5      |
| 250 mm | 2000 g     | 4        | W-S-2.0      |
| 260 mm | 2500 g     | 4        | W-S-2.5      |







**BAHCO**



## Cold Chisels & Punches



## COLD CHISELS

Flat Cold Chisels with Octagonal Shank, Plastic Covered



### 3656

| L      | W       | QTY | SKU      |
|--------|---------|-----|----------|
| 129 mm | 12 mm   | 50  | 3656-125 |
| 155 mm | 16 mm   | 50  | 3656-150 |
| 178 mm | 19.5 mm | 1   | 3656-175 |

Cold Chisels with Flat Oval Shank and Phosphate Finish



### 3640

| L      | W     | QTY | SKU        |
|--------|-------|-----|------------|
| 150 mm | 18 mm | 25  | 3640-150-C |
| 200 mm | 22 mm | 25  | 3640-200-C |
| 250 mm | 28 mm | 20  | 3640-250-C |
| 300 mm | 26 mm | 25  | 3640-300-C |

Cold Cape Chisels with Flat Oval Shank and Lacquered Copper Finish



### 3745

| L      | W    | QTY | SKU      |
|--------|------|-----|----------|
| 150 mm | 6 mm | 50  | 3745-150 |
| 175 mm | 7 mm | 25  | 3745-175 |
| 200 mm | 8 mm | 20  | 3745-200 |
| 250 mm | 9 mm | 10  | 3745-250 |

Cold Chisels with Flat Oval Shank and Lacquered Copper Finish



### 3740

| L      | QTY | SKU      |
|--------|-----|----------|
| 100 mm | 50  | 3740-100 |
| 125 mm | 50  | 3740-125 |
| 150 mm | 50  | 3740-150 |
| 175 mm | 25  | 3740-175 |
| 200 mm | 25  | 3740-200 |
| 250 mm | 10  | 3740-250 |
| 300 mm | 10  | 3740-300 |

Flat Cold Chisels with Octagonal Shank and Lacquered Copper Finish



### 3756

| L      | W     | QTY | SKU      |
|--------|-------|-----|----------|
| 125 mm | 10 mm | 50  | 3756-125 |
| 150 mm | 12 mm | 50  | 3756-150 |

Cold Cape Chisel with Octagonal Shank and Lacquered Copper Finish



### 3749

| L      | W     | QTY | SKU      |
|--------|-------|-----|----------|
| 125 mm | 10 mm | 50  | 3749-125 |

Cold Chisels with Flat Oval Shank and Lacquered Copper Finish Retail Pack



### SB-3740

| L      | QTY | SKU         |
|--------|-----|-------------|
| 125 mm | 87  | SB-3740-125 |
| 150 mm | 25  | SB-3740-150 |
| 175 mm | 25  | SB-3740-175 |
| 200 mm | 25  | SB-3740-200 |
| 250 mm | 25  | SB-3740-250 |
| 300 mm | 25  | SB-3740-300 |

Cold Cape Chisels with Flat Octagonal Shank, Plastic Covered



### 3649

| L      | W     | QTY | SKU      |
|--------|-------|-----|----------|
| 128 mm | 12 mm | 50  | 3649-125 |

Slitting Chisels with Flat Oval Shank and Lacquered Copper Finish



### 3750

| L      | W     | QTY | SKU  |
|--------|-------|-----|------|
| 240 mm | 26 mm | 25  | 3750 |

Mason's Chisels with Octagonal Shank and Lacquered Copper Finish



**3736M**

| L      |    | Icons     |  |
|--------|----|-----------|--|
| 200 mm | 30 | 3736M-200 |  |
| 250 mm | 25 | 3736M-250 |  |
| 300 mm | 10 | 3736M-300 |  |
| 400 mm | 10 | 3736M-400 |  |

Pointed Chisels with Octagonal Shank and Lacquered Copper Finish



**3739-250 / -400**

| L      |       | Ø  | Icons    |  |
|--------|-------|----|----------|--|
| 250 mm | 16 mm | 25 | 3739-250 |  |
| 300 mm | 18 mm | 10 | 3739-300 |  |
| 400 mm | 18 mm | 10 | 3739-400 |  |

Pointed Chisels with Octagonal Shank and Guard



**3739H**

| L      |       | Ø  | Icons     |  |
|--------|-------|----|-----------|--|
| 250 mm | 16 mm | 15 | 3739H-250 |  |
| 300 mm | 18 mm | 10 | 3739H-300 |  |
| 400 mm | 18 mm | 10 | 3739H-400 |  |

Mason's Chisels with Long Flat Shank



**8740**

| L      |   | Icons     |  |
|--------|---|-----------|--|
| 200 mm | 5 | 874002000 |  |
| 250 mm | 5 | 874002500 |  |
| 300 mm | 5 | 874003000 |  |
| 350 mm | 5 | 874003500 |  |
| 400 mm | 5 | 874004000 |  |
| 500 mm | 5 | 874005000 |  |

**COLD CHISELS WITH GUARD**

Slitting Chisels with Flat Oval Shank and Guard



**3750H**

| L      |    | Icons |  |
|--------|----|-------|--|
| 240 mm | 25 | 3750H |  |

**COLD CHISELS, REGRINDABLE**

Regrindable Cold Chisels with Flat Shank and Guard



**8741**

| L      |   | Icons     |  |
|--------|---|-----------|--|
| 200 mm | 6 | 874102000 |  |
| 250 mm | 5 | 874102500 |  |
| 300 mm | 5 | 874103000 |  |
| 350 mm | 4 | 874103500 |  |
| 400 mm | 5 | 874104000 |  |

Mixed Chisel Set with Lacquered Copper Finish - 6 Pcs/Box



**3736S/6**

| g     | Icons |         |
|-------|-------|---------|
| 840 g | 5     | 3736S/6 |

3735-4-120, 3735-5-150

3733-3

3749-125

3756-125, 3756-150

Mason's Chisels with Octagonal Shank and Guard



**3736MH**

| L      |    | Icons      |  |
|--------|----|------------|--|
| 250 mm | 10 | 3736MH-250 |  |
| 300 mm | 10 | 3736MH-300 |  |
| 400 mm | 5  | 3736MH-400 |  |

Regrindable Pointed Chisels with Octagonal Shank



**8746**

| L      |       | Ø | Icons     |  |
|--------|-------|---|-----------|--|
| 200 mm | 14 mm | 5 | 874602000 |  |
| 250 mm | 14 mm | 5 | 874602500 |  |
| 300 mm | 16 mm | 5 | 874603000 |  |
| 350 mm | 16 mm | 5 | 874603500 |  |
| 400 mm | 18 mm | 5 | 874604000 |  |



Electrician Regrindable Chisels with Octagonal Shank



**8760**

| L      | Icon 1 | Icon 2 | QTY | Part No.  |
|--------|--------|--------|-----|-----------|
| 200 mm |        |        | 10  | 876002000 |
| 250 mm |        |        | 5   | 876002500 |

Regrindable Cold Chisels with Extra Flat Shank



**8770**

| L      | Icon 1 | Icon 2 | QTY | Part No.  |
|--------|--------|--------|-----|-----------|
| 240 mm |        |        | 25  | 877002400 |

**COLD CHISELS ACCESSORIES**

Handles for Cold Chisels



**8749**

| Icon | Icon 1 | Icon 2 | QTY | Part No.  |
|------|--------|--------|-----|-----------|
|      |        |        | 1   | 874916X16 |
|      |        |        | 1   | 874918X18 |
|      |        |        | 1   | 874923X13 |
|      |        |        | 1   | 874926X7  |

**PUNCHES**

Centre Punches with Octagonal Shank and Hand Protection



**3643**

| Icon | L    | Icon 1 | Icon 2 | QTY | Part No. |
|------|------|--------|--------|-----|----------|
|      |      |        |        | 50  | 3643-100 |
|      | 3 mm | 100 mm |        | 50  | 3643-120 |
|      | 4 mm | 120 mm |        | 50  | 3643-150 |
|      | 5 mm | 120 mm |        | 50  | 3643-150 |

Centre Punches with Octagonal Shank and Lacquered Copper Finish



**3735**

| Icon | L    | Icon 1 | Icon 2 | QTY | Part No.   |
|------|------|--------|--------|-----|------------|
|      |      |        |        | 50  | 3735-4-120 |
|      | 4 mm | 120 mm |        | 50  | 3735-5-120 |
|      | 5 mm | 120 mm |        | 50  | 3735-5-150 |
|      | 5 mm | 150 mm |        | 50  | 3735-5-150 |

Centre Punches with Hexagonal Shank and Chrome Finish



**3735N**

| Icon | L    | Icon 1 | Icon 2 | QTY | Part No.       |
|------|------|--------|--------|-----|----------------|
|      |      |        |        | 10  | 3735N-2-100    |
|      | 2 mm | 100 mm |        | 10  | 3735N-4-120    |
|      | 4 mm | 120 mm |        | 10  | 3735N-5-120    |
|      | 5 mm | 120 mm |        | 10  | 3735N-6-150    |
|      | 6 mm | 150 mm |        | 10  | 3735N-8-150    |
|      | 8 mm | 150 mm |        | 1   | SB-3735N-2-100 |
|      | 2 mm | 100 mm |        | 60  | SB-3735N-4-120 |
|      | 4 mm | 120 mm |        | 1   | SB-3735N-5-120 |
|      | 5 mm | 120 mm |        | 1   | SB-3735N-6-150 |
|      | 6 mm | 150 mm |        | 1   | SB-3735N-8-150 |
|      | 8 mm | 150 mm |        | 1   | SB-3735N-8-150 |

SB: With hanging clip

Centre Punch Set with Chrome Finish - 4 Pcs/Wallet



**3735NS/4**

| g     | Icon 1 | Icon 2 | QTY | Part No. |
|-------|--------|--------|-----|----------|
| 340 g |        |        | 25  | 3735NS/4 |

3735N-6-150, 3735N-8-150, 3735N-2-100, 3735N-4-120

Automatic Centre Punches with Hardened Steel Point



**1157**

| Icon | L    | Icon 1 | Icon 2 | QTY | Part No. |
|------|------|--------|--------|-----|----------|
|      |      |        |        | 60  | 1157     |
|      | 2 mm | 130 mm |        |     |          |

Drift Punches with Octagonal Shank and Hand Protection



**3644**

| Icon | L    | Icon 1 | Icon 2 | QTY | Part No. |
|------|------|--------|--------|-----|----------|
|      |      |        |        | 50  | 3644-120 |
|      | 2 mm | 120 mm |        | 50  | 3644-125 |
|      | 3 mm | 125 mm |        | 50  | 3644-130 |
|      | 4 mm | 130 mm |        | 50  | 3644-150 |
|      | 4 mm | 150 mm |        | 50  | 3644-165 |
|      | 5 mm | 165 mm |        | 50  | 3644-180 |
|      | 6 mm | 180 mm |        | 50  | 3644-200 |
|      | 8 mm | 200 mm |        | 50  | 3644-200 |



Cylindrical Drift Punches with Knurled Guide Sleeve



**3659**

| Ø      | L      | Icon 1 | Icon 2   |
|--------|--------|--------|----------|
| 0.9 mm | 70 mm  | 5      | 3659-0.9 |
| 1.4 mm | 81 mm  | 5      | 3659-1.4 |
| 1.8 mm | 84 mm  | 5      | 3659-1.8 |
| 2.4 mm | 92 mm  | 5      | 3659-2.4 |
| 2.8 mm | 95 mm  | 5      | 3659-2.8 |
| 3.4 mm | 97 mm  | 5      | 3659-3.4 |
| 3.9 mm | 100 mm | 5      | 3659-3.9 |
| 5.9 mm | 100 mm | 5      | 3659-6.0 |

Cylindrical Drift Punches with Octagonal Shank and Hand Protection



**3658A**

| Ø    | L      | Icon 1 | Icon 2  |
|------|--------|--------|---------|
| 2 mm | 150 mm | 125    | 3658A-2 |
| 3 mm | 150 mm | 125    | 3658A-3 |
| 4 mm | 150 mm | 125    | 3658A-4 |
| 5 mm | 150 mm | 125    | 3658A-5 |
| 6 mm | 150 mm | 125    | 3658A-6 |
| 8 mm | 150 mm | 50     | 3658A-8 |

| Ø     | L      | Icon 1 | Icon 2          |
|-------|--------|--------|-----------------|
| 8 mm  | 150 mm | 10     | 3734N-8-150     |
| 9 mm  | 150 mm | 10     | 3734N-9-150     |
| 10 mm | 150 mm | 10     | 3734N-10-150    |
| 2 mm  | 150 mm | 1      | SB-3734N-2-150  |
| 3 mm  | 150 mm | 1      | SB-3734N-3-150  |
| 4 mm  | 150 mm | 60     | SB-3734N-4-150  |
| 5 mm  | 150 mm | 1      | SB-3734N-5-150  |
| 6 mm  | 150 mm | 60     | SB-3734N-6-150  |
| 7 mm  | 150 mm | 1      | SB-3734N-7-150  |
| 8 mm  | 150 mm | 1      | SB-3734N-8-150  |
| 10 mm | 150 mm | 1      | SB-3734N-10-150 |

Conical Drift Punches with Octagonal Shank and Lacquered Copper Finish



**3733**

| Ø    | L      | Icon 1 | Icon 2 |
|------|--------|--------|--------|
| 2 mm | 120 mm | 50     | 3733-2 |
| 3 mm | 120 mm | 50     | 3733-3 |
| 4 mm | 120 mm | 50     | 3733-4 |
| 5 mm | 120 mm | 50     | 3733-5 |
| 6 mm | 120 mm | 50     | 3733-6 |

Cylindrical Drift Punches with Octagonal Shank and Lacquered Copper Finish



**3734**

| Ø    | L      | Icon 1 | Icon 2 |
|------|--------|--------|--------|
| 2 mm | 150 mm | 50     | 3734-2 |
| 3 mm | 150 mm | 50     | 3734-3 |
| 4 mm | 150 mm | 50     | 3734-4 |
| 5 mm | 150 mm | 50     | 3734-5 |
| 6 mm | 150 mm | 50     | 3734-6 |
| 8 mm | 150 mm | 50     | 3734-8 |

Fine Grounded Pin Drift Punch Set with Hand Protection - 6 Pcs/Wooden Stand



**3646/6**

| g     | Icon 1 | Icon 2 |
|-------|--------|--------|
| 730 g | 25     | 3646/6 |

3646-115, 3646-125, 3646-150, 3646-165, 3646-180, 3646-200



Fine Grounded Pin Cylindrical Drift Punches with Octagonal Shank and Hand Protection



**3646**

| Ø    | L      | Icon 1 | Icon 2   |
|------|--------|--------|----------|
| 2 mm | 115 mm | 250    | 3646-115 |
| 3 mm | 125 mm | 250    | 3646-125 |
| 4 mm | 150 mm | 125    | 3646-150 |
| 5 mm | 165 mm | 125    | 3646-165 |
| 6 mm | 180 mm | 50     | 3646-180 |
| 8 mm | 200 mm | 50     | 3646-200 |

Cylindrical Drift Punches with Hexagonal Shank



**3734N**

| Ø    | L      | Icon 1 | Icon 2      |
|------|--------|--------|-------------|
| 2 mm | 150 mm | 10     | 3734N-2-150 |
| 3 mm | 150 mm | 10     | 3734N-3-150 |
| 4 mm | 150 mm | 10     | 3734N-4-150 |
| 5 mm | 150 mm | 10     | 3734N-5-150 |
| 6 mm | 150 mm | 10     | 3734N-6-150 |
| 7 mm | 150 mm | 10     | 3734N-7-150 |

Chisel and Drift Punch Set - 6 Pcs/Plastic Wallet



**3654R**

| g     | Icon 1 | Icon 2 |
|-------|--------|--------|
| 870 g | 1      | 3654R  |

2 x 3656, 1 x 3649, 2 x 3644, 1 x 3643



Drift Punch Set with Knurled Guide Sleeve - 8 Pcs/Plastic Stand



**3659/8**

|       |   |        |
|-------|---|--------|
|       |   |        |
| 270 g | 1 | 3659/8 |

3659-0.9, 3659-1.4, 3659-1.8, 3659-2.4, 3659-2.8, 3659-3.4, 3659-3.9, 3659-6.0

Cylindrical Drift Punch Set with Hand Protection - 6 Pcs/Wooden Stand



**3658A/6**

|       |    |         |
|-------|----|---------|
|       |    |         |
| 560 g | 30 | 3658A/6 |

3658A-2, 3658A-3, 3658A-4, 3658A-5, 3658A-6, 3658A-8

Cylindrical Drift Punch Set with Hexagonal Shank - 9 Pcs/Wallet



**3734NS/9**

|       |    |          |
|-------|----|----------|
|       |    |          |
| 750 g | 10 | 3734NS/9 |

3734N-10-150, 3734N-9-150, 3734N-8-150, 3734N-7-150, 3734N-6-150, 3734N-5-150, 3734N-4-150, 3734N-3-150, 3734N-2-150

Cylindrical Drift Punch Set with Octagonal Shank - 6 Pcs/Box



**3734S/6**

|       |   |         |
|-------|---|---------|
|       |   |         |
| 720 g | 5 | 3734S/6 |

3734-2, 3734-3, 3734-4, 3734-5, 3734-6, 3734-8

Drift Punch Set with Knurled Guide Sleeve - 8 Pcs/Plastic Wallet



**3659/8T**

|       |   |         |
|-------|---|---------|
|       |   |         |
| 170 g | 1 | 3659/8T |

3659-0.9, 3659-2.8, 3659-2.4, 3659-1.8, 3659-6.0, 3659-3.9, 3659-3.4, 3659-1.4

Nail Drift Punches with Plastic Handle Retail Pack



**3732**

|        |        |    |                 |
|--------|--------|----|-----------------|
|        |        |    |                 |
| 2 mm   | 125 mm | 60 | SB-3732-2-125   |
| 2.5 mm | 125 mm | 60 | SB-3732-2.5-125 |
| 3.2 mm | 125 mm | 60 | SB-3732-3.2-125 |
| 4 mm   | 125 mm | 1  | SB-3732-4-125   |

Chisel and Drift Punch Set - 10 Pcs/Plastic Wallet



**3656/10**

|        |   |         |
|--------|---|---------|
|        |   |         |
| 1260 g | 1 | 3656/10 |

3 x 3656, 1 x 3644, 1 x 3649, 1 x 3643 en 3 x 3646

Conical Drift Punch Set with Octagonal Shank - 5 Pcs/Wallet



**3733S/5**

|       |    |         |
|-------|----|---------|
|       |    |         |
| 410 g | 25 | 3733S/5 |



3733-4, 3733-2, 3733-6  
3733-8, 3733-10

Wad Punch Noses



**B400**



|      |   |          |
|------|---|----------|
|      |   |          |
| 2 mm | 1 | B400.002 |
| 3 mm | 1 | B400.003 |
| 4 mm | 1 | B400.004 |
| 5 mm | 1 | B400.005 |
| 6 mm | 1 | B400.006 |
| 7 mm | 1 | B400.007 |

|    |            |
|--|------------|
| 8 mm   | 1 B400.008 |
| 9 mm   | 1 B400.009 |
| 10 mm  | 1 B400.010 |
| 11 mm  | 1 B400.011 |
| 12 mm  | 1 B400.012 |
| 13 mm  | 1 B400.013 |
| 14 mm  | 1 B400.014 |
| 15 mm  | 1 B400.015 |
| 16 mm  | 1 B400.016 |
| 17 mm  | 1 B400.017 |
| 18 mm  | 1 B400.018 |
| 19 mm  | 1 B400.019 |
| 20 mm  | 1 B400.020 |
| 21 mm  | 1 B400.021 |
| 22 mm  | 1 B400.022 |
| 23 mm  | 1 B400.023 |
| 24 mm  | 1 B400.024 |
| 25 mm  | 1 B400.025 |
| 26 mm  | 1 B400.026 |
| 27 mm  | 1 B400.027 |
| 28 mm  | 1 B400.028 |
| 29 mm  | 1 B400.029 |
| 30 mm  | 1 B400.030 |
| 31 mm  | 1 B400.031 |
| 32 mm  | 1 B400.032 |
| 33 mm  | 1 B400.033 |
| 34 mm  | 1 B400.034 |
| 35 mm  | 1 B400.035 |
| 36 mm  | 1 B400.036 |
| 37 mm  | 1 B400.037 |
| 38 mm  | 1 B400.038 |
| 39 mm  | 1 B400.039 |
| 40 mm  | 1 B400.040 |
| 41 mm  | 1 B400.041 |
| 42 mm  | 1 B400.042 |
| 43 mm  | 1 B400.043 |
| 44 mm  | 1 B400.044 |
| 45 mm  | 1 B400.045 |
| 46 mm  | 1 B400.046 |
| 47 mm  | 1 B400.047 |
| 48 mm  | 1 B400.048 |
| 49 mm  | 1 B400.049 |
| 50 mm  | 1 B400.050 |

Handles for 2 mm-30 mm Wad Punches



**WPH3-30**

|   |   |   |   |
|---|---|---|---|
|  |  |  |  |
| 185 mm  | 500 g   | 1   | WPH 3-30  |

Interchangeable Wad Punch Set - 16 Pcs/  
Plastic Case



**400.003.030**

|   |   |   |
|---|---|---|
|  |  |  |
| 3-30 mm   | 1   | 400.003.030   |

Handles for 2 mm-50 mm Wad Punches



**WPH2-50**

|   |   |   |   |
|---|---|---|---|
|  |  |  |  |
| 180 mm  | 761 g   | 1   | WPH 2-50  |

Interchangeable Wad Punch Set - 32 Pcs/  
Plastic Case



**400.002.050**

|   |   |   |
|---|---|---|
|  |  |  |
| 2-50 mm   | 1   | 400.002.050   |

Handles for 2 mm-20 mm Wad Punches



**WPH3-20**

|  |   |   |   |
|--|---|---|---|
|  |  |  |  |
| 95 mm  | 290 g   | 1   | WPH 3-20  |

Interchangeable Wad Punch Set - 11 Pcs/  
Plastic Case



**400.003.020**

|   |   |   |
|---|---|---|
|  |  |  |
| 3-20 mm   | 1   | 400.003.020   |

Revolving Wad Punches with Plastic  
Handle for 2 mm-4.5 mm



**2635**

|   |   |   |
|---|---|---|
|  |  |  |
| 245 mm  | 1   | 2635  |



Revolving Wad Punches for 2 mm-4.5 mm



**4630**



220 mm



1 4630

Knockout Screw Hole Punches



**6900**



16 mm  
20 mm  
22 mm  
25 mm  
30 mm  
32 mm  
35 mm  
40 mm  
50 mm  
63 mm



1 690000160  
1 690000200  
1 690000220  
1 690000250  
1 690000300  
1 690000320  
1 690000350  
1 690000400  
1 690000500  
1 690000630

Screw Punch Set - 7 Pcs/Plastic Box



**6907**



4080 g



1 69079019P

690000160, 690000250, 690000200, 690000320,  
690000500, 690000400, 690000630



690900120, 690900080, 690900100, 690900200,  
690900140



Spare Screws for 6900 Series Screw Punchers



**6909**



16 mm  
20-25 mm  
30-35 mm  
40-50 mm  
63 mm



4 690900080  
4 690900100  
2 690900120  
2 690900140  
1 690900200

**PUNCHES WITH 2-COMPONENT HANDLE**

Centre Punch with 2-Component Handle and Guard



**SB3755BM**



4 mm 165 mm  
6 mm 185 mm



1 SB3755BM-4  
5 SB3755BM-6

SB: Retail pack

Cylindrical Parallel Pin Punch with 2-Component Handle



**SB3734BM**



10 mm 180 mm  
3 mm 155 mm  
4 mm 165 mm  
5 mm 165 mm  
6 mm 185 mm  
8 mm 185 mm



5 SB3734BM-10  
5 SB3734BM-3  
5 SB3734BM-4  
5 SB3734BM-5  
5 SB3734BM-6  
5 SB3734BM-8

SB: Retail pack

Cylindrical Pin Punch Set with Dual-Component Handle - 7 Pcs/Plastic Tray



**3734BMS/7**



900 g



1 3734BMS/7

3734BM-2, 3734BM-3, 3734BM-4, 3734BM-5, 3734BM-6, 3734BM-8, 3734BM-10

**COLD CHISELS WITH 2-COMPONENT HANDLE**

Mason's Chisels with 2-component handle



**SB3654BM**



155 mm  
185 mm



5 SB3654BM-15  
5 SB3654BM-20

SB: Retail pack

Mixed Mason's Chisel Set with Dual-Component Handle - 7 Pcs/Plastic Tray



**3654BMS/7**



920 g



1 3654BMS/7

3734BM-2, 3734BM-4, 3734BM-5, 3734BM-6, 3654BM-15, 3654BM-20, 3755BM-6



## Pry Bars





## WRECKING BARS

Adjustable Pry Bars with V-Claw 260 mm



### APB260

|        |       |    |        |
|--------|-------|----|--------|
|        |       |    |        |
| 260 mm | 410 g | 10 | APB260 |

Adjustable Pry Bars with V-Claw 360 mm



### APB360

|        |       |    |        |
|--------|-------|----|--------|
|        |       |    |        |
| 360 mm | 543 g | 10 | APB360 |

Pry Bar Crowfoots with Precise End



### CFP250

|        |   |        |
|--------|---|--------|
|        |   |        |
| 250 mm | 6 | CFP250 |

Premium Wrecking Bars with Bent and Flat End



### WBP

|       |        |    |        |
|-------|--------|----|--------|
|       |        |    |        |
| 14 mm | 346 mm | 20 | WBP300 |
| 16 mm | 487 mm | 12 | WBP500 |
| 17 mm | 625 mm | 12 | WBP625 |
| 17 mm | 704 mm | 10 | WBP710 |
| 20 mm | 890 mm | 6  | WBP900 |

Wrecking Bars with Bent and Flat End



### WBB

|         |       |    |         |
|---------|-------|----|---------|
|         |       |    |         |
| 391 mm  | 14 mm | 10 | WBB400  |
| 500 mm  | 16 mm | 10 | WBB500  |
| 595 mm  | 18 mm | 10 | WBB600  |
| 680 mm  | 18 mm | 6  | WBB700  |
| 810 mm  | 18 mm | 6  | WBB800  |
| 1000 mm | 20 mm | 4  | WBB1000 |
| 1200 mm | 20 mm | 4  | WBB1200 |
| 1500 mm | 22 mm | 4  | WBB1500 |

Flat Wrecking Bars with Bent and Flat End



### WBF380

|        |       |    |        |
|--------|-------|----|--------|
|        |       |    |        |
| 374 mm | 35 mm | 12 | WBF380 |

Mini Flat Wrecking Bars with Bent and Flat End



### WBMF190

|       |        |    |         |
|-------|--------|----|---------|
|       |        |    |         |
| 18 mm | 188 mm | 24 | WBMF190 |

Mini Flat Wrecking Bars with Bent and Flat End - 15 Pcs/Display



### WBMF190IP

|      |    |           |
|------|----|-----------|
|      |    |           |
| 39 g | 15 | WBMF190IP |

WBMF190x 15

Wrecking Bar Set - Flat, Mini & Premium with End 346 mm



### WBP-3P-3FMF

|        |   |             |
|--------|---|-------------|
|        |   |             |
| 1600 g | 1 | WBP-3P-3FMF |

WBP300

WBF380

WBMF190

Wrecking Bar Set - Flat, Mini & Premium  
with End 621 mm



**WBP-3P-6FMF**

|        |   |             |
|--------|---|-------------|
|        |   |             |
| 3000 g | 1 | WBP-3P-6FMF |

- WBP625
- WBF380
- WBMF190

Premium Wrecking Bar Set



**WBP-3P-963**

|        |   |            |
|--------|---|------------|
|        |   |            |
| 4740 g | 1 | WBP-3P-963 |

- WBP900, WBP625, WBP300

Flat & Premium Wrecking Bar Set



**WBP-3P-96F**

|        |   |            |
|--------|---|------------|
|        |   |            |
| 6000 g | 1 | WBP-3P-96F |

- WBP900, WBP625
- WBF380





**BAHCO**



## Planting & Cultivating Tools



## SMALL GARDEN TOOLS

Hoes with Dual-Component Handle



**P262**



315 mm



10 P262

One Point Hoes with Dual-Component Handle and Long Metal Rod



**P278**



455 mm



5 P278

Trowels with Dual-Component Handle



**P263**



370 mm



10 P263

Border Hoes with Dual-Component Handle



**P272**



450 mm



5 P272

Two Point Hoes with Dual-Component Handle



**P267**



320 mm



10 P267

Cultivators with Dual-Component Handle



**P264**



315 mm



10 P264

One Point Hoes with Dual-Component Handle



**P268**



320 mm



10 P268

Two Point Hoes with Dual-Component Handle and Long Metal Rod



**P277**



455 mm



5 P277

Border Cultivators with Dual-Component Handle



**P274**



470 mm



5 P274



Border Rakes with Dual-Component Handle



**P276**



450 mm



5 P276

Weeding Forks with Dual-Component Handle



**P270**



305 mm



10 P270

Rakes with Dual-Component Handle



**P266**



335 mm



10 P266

Bulb Planters with Solid Wooden Handle



**P241**



340 g



5 P241

Daisy Grubbers with Dual-Component Handle



**P269**



315 mm



10 P269



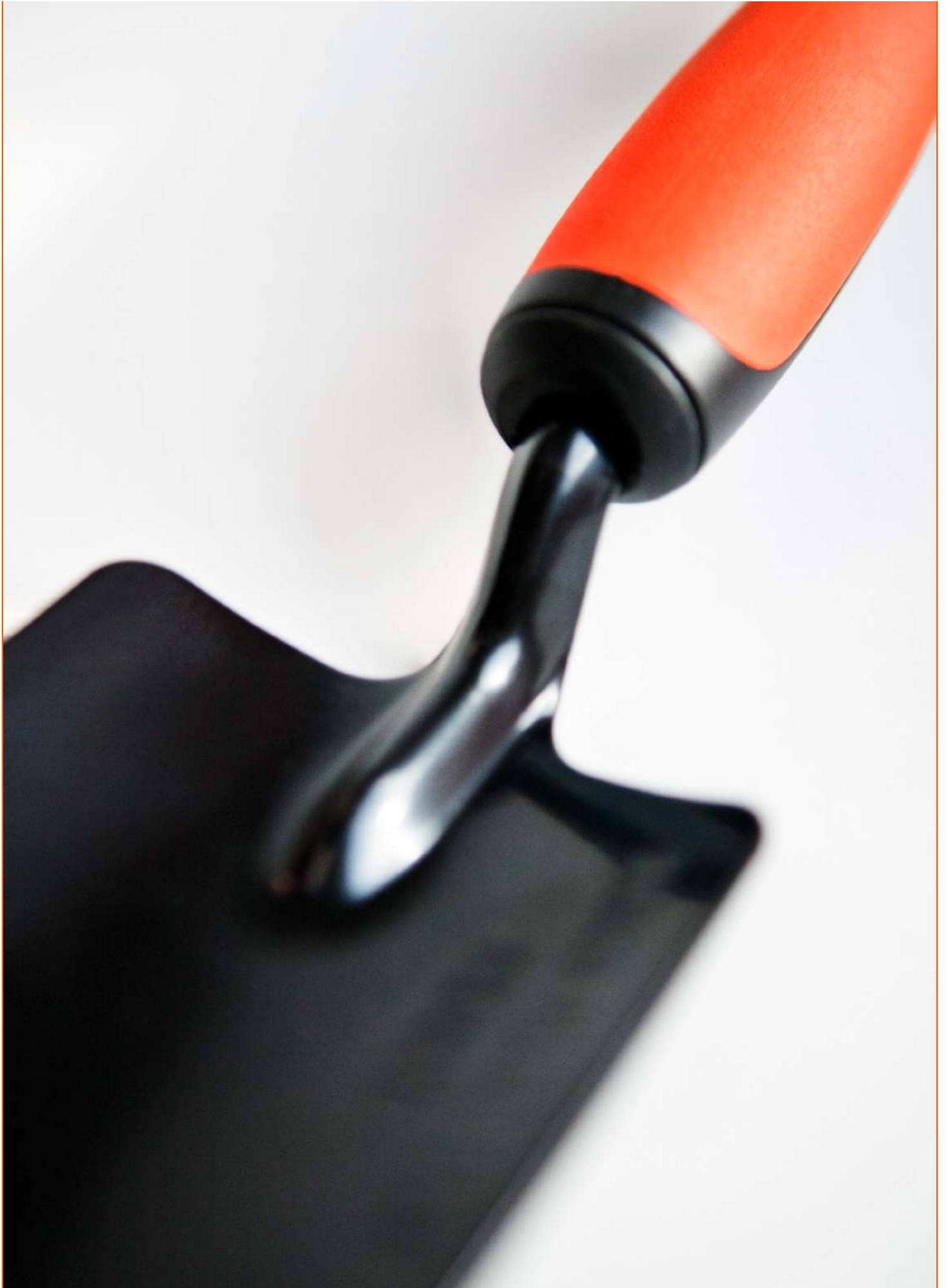

**BAHCO**



## Pruning Tools



## SECATEURS

ERGO™ Bypass Secateurs with Elastomer Coated Fixed Handle



ergo



### PX

| Blade Length | Quantity | Part Number |
|--------------|----------|-------------|
| 15 mm        | 2        | PX-S1       |
| 20 mm        | 2        | PX-S2       |
| 15 mm        | 2        | PX-M1       |
| 20 mm        | 2        | PX-M2       |
| 20 mm        | 2        | PX-M2-L     |
| 30 mm        | 2        | PX-M3       |
| 20 mm        | 2        | PX-L2       |
| 30 mm        | 2        | PX-L3       |

ERGO™ Bypass Secateurs with Elastomer Coated Rotating Handle



ergo



### PXR

| Blade Length | Quantity | Part Number |
|--------------|----------|-------------|
| 20 mm        | 2        | PXR-S2-L    |
| 15 mm        | 2        | PXR-S1      |
| 20 mm        | 2        | PXR-S2      |
| 15 mm        | 2        | PXR-M1      |
| 20 mm        | 2        | PXR-M2      |
| 20 mm        | 2        | PXR-M2-L    |
| 30 mm        | 2        | PXR-M3      |
| 20 mm        | 2        | PXR-L2      |

Spare Pre-assembled Cutting Heads for PX and PXR ERGO™ Bypass Secateurs



### R801P-R804P

| Quantity | Part Number |
|----------|-------------|
| 1        | R801P       |
| 1        | R802P       |
| 1        | R803P       |
| 2        | R804P       |

Spare Cutting Blades for ERGO™ Bypass Secateurs



### R211P/R300P/R500P/R600P

| Quantity | Part Number  |
|----------|--------------|
| 1        | R211P        |
| 80       | R211P-BULK80 |
| 1        | R300P        |
| 40       | R500P        |
| 1        | R600P        |

Spare Counter Blades for PX and PXR ERGO™ Bypass Secateurs



### R303P-R603P

| Quantity | Part Number |
|----------|-------------|
| 1        | R303P       |
| 1        | R403P       |
| 1        | R503P       |
| 1        | R603P       |

Spare Pair of Handles for PX and PXR ERGO™ Bypass Secateurs



ergo



### R811P-RT825P

| Quantity | Part Number |
|----------|-------------|
| 1        | R811P       |
| 1        | R812P       |
| 1        | R813P       |
| 1        | R815P       |
| 1        | RT821P      |
| 1        | RT822P      |
| 6        | RT823P      |
| 1        | RT824P      |
| 6        | RT825P      |

Spare Centre Bolts for ERGO™ Bypass Secateurs



### R900P

| Weight | Quantity | Part Number |
|--------|----------|-------------|
| 20 g   | 1        | R900P       |

Spare Centre Bolt Locking Systems for ERGO™ Bypass Secateurs



### R901P

| Weight | Quantity | Part Number |
|--------|----------|-------------|
| 10 g   | 30       | R901P       |

Spare Four Handle Screws with Inserts for PX and PXR ERGO™ Bypass Secateurs



**R902P**

| Icon     | g    | Icon     |
|----------|------|----------|
|          | 20 g |          |
| PX & PXR |      | 24 R902P |

Spare Springs for P64 and ERGO™ Bypass Secateurs



**R905P-R907P**

| Icon          | g     | Icon            |
|---------------|-------|-----------------|
|               |       |                 |
| PX & PXR, P64 | 10 g  | 1 R905P         |
| PX & PXR, P64 | 164 g | 50 R905P-BULK50 |
| PX & PXR      | 10 g  | 1 R906P         |
| PX & PXR      | 220 g | 50 R906P-BULK50 |
| PX & PXR      | 10 g  | 1 R907P         |

Bypass Secateurs with Composite Handle and Angled Head



**P1**

| Icon  | L      | Icon    |
|-------|--------|---------|
|       | 200 mm |         |
| 20 mm |        | 5 P1-20 |
| 30 mm | 230 mm | 5 P1-23 |

Spare Two Buffers for PX/PXR, P1/P2, P64 ERGO™ Bypass Secateurs



**R903P/R1269P**

| Icon                   | g     | Icon             |
|------------------------|-------|------------------|
|                        |       |                  |
| PX & PXR, P1 & P2, P64 | 10 g  | 1 R903P          |
| PX & PXR, P1 & P2, P64 | 486 g | 50 R1269P-BULK50 |

Bypass Secateurs with Forged Steel Handle and Large Cutting Head



**P3**

| Icon  | Icon      |
|-------|-----------|
|       |           |
| 20 mm | 2 P3-20-F |
| 25 mm | 2 P3-23-F |

Bypass Secateurs with Soft Grip Composite Handle and Narrow Cutting Head



**P108**

| Icon  | L      | Icon        |
|-------|--------|-------------|
|       | 200 mm |             |
| 20 mm |        | 2 P108-20-F |
| 25 mm | 230 mm | 2 P108-23-F |

Spare Locking Devices for PX and PXR ERGO™ Bypass Secateurs



**R904P**

| Icon     | g    | Icon    |
|----------|------|---------|
|          | 10 g |         |
| Px & Pxr |      | 1 R904P |

Bypass Secateurs with Stamped/Pressed Steel Handle and Narrow Cutting Head



**P110**

| Icon  | Icon        |
|-------|-------------|
|       |             |
| 20 mm | 2 P110-20-F |
| 25 mm | 2 P110-23-F |

Bypass Secateurs with Forged Steel Handle and Narrow Cutting Head



**P5**

| Icon  | L      | Icon      |
|-------|--------|-----------|
|       | 230 mm |           |
| 25 mm |        | 2 P5-23-F |





Anvil Secateurs with Stamped/Pressed Steel Handle



**P138**

| Blade Width | Length (L) | Quantity | Product Code  |
|-------------|------------|----------|---------------|
| 20 mm       | 220 mm     | 6        | P138-22-BULK6 |
| 20 mm       | 220 mm     | 6        | P138-22-F     |

Bypass Secateurs with Stamped/Pressed Steel Handle and Angled Cutting Head



**P121**

| Blade Width | Length (L) | Quantity | Product Code |
|-------------|------------|----------|--------------|
| 15 mm       | 180 mm     | 6        | P121-18-F    |
| 20 mm       | 200 mm     | 6        | P121-20-F    |
| 25 mm       | 230 mm     | 6        | P121-23-F    |

Spare Anvils and Rivets



**R221P/R222P**

| Product Code | Quantity | Product Code |
|--------------|----------|--------------|
| P138-22      | 1        | R221P        |
| P138-22      | 50       | R221P-BULK50 |

Cut and Hold Secateurs with Composite Handle



**P64**

| Blade Width | Length (L) | Quantity | Product Code  |
|-------------|------------|----------|---------------|
| 12 mm       | 210 mm     | 12       | P64-20-BULK12 |

Bypass Secateurs with Stamped/Pressed Steel Handle and Straight Cutting Head



**P126**

| Blade Width | Length (L) | Quantity | Product Code |
|-------------|------------|----------|--------------|
| 15 mm       | 190 mm     | 6        | P126-19-F    |
| 20 mm       | 220 mm     | 6        | P126-22-F    |

Spare Cutting Blades for P1-22, P2-22, P6 Bypass Pruners/P7 Left-Handed Pruners



**R201P/R171P**

| Product Code | Quantity | Product Code |
|--------------|----------|--------------|
| P1-22, P2-22 | 1        | R201P        |
| P1-22, P2-22 | 80       | R201P-BULK80 |

Left and Right Handed Bypass Secateurs with Fibreglass Handle



**PG-01-F/PG-03-L**

| Blade Width | Quantity | Product Code |
|-------------|----------|--------------|
| 12-20 mm    | 6        | PG-01-F      |
| 12-20 mm    | 2        | PG-03-L      |

Left and Right Handed Bypass Secateurs with Composite Handle



**PG-12-F**

| Blade Width | Length (L) | Quantity | Product Code |
|-------------|------------|----------|--------------|
| 20 mm       | 210 mm     | 10       | PG-12-F      |
| 20 mm       | 210 mm     | 15       | PG-12-BULK15 |

Spare Cutting Blades for Hand and Top-Pruners



**R112PG-R124PG/R224P**

| Product Code              | Quantity | Product Code |
|---------------------------|----------|--------------|
| P3-20, P5-20              | 1        | R112PG       |
| P108-20, P110-20          | 1        | R114PG       |
| P3-23, P5-23              | 30       | R122PG       |
| P108-23, P110-23, P34-27A | 30       | R124PG       |
| P138-22                   | 1        | R223P        |
| P138-22                   | 80       | R223P-BULK80 |

Spare Counter Blades for P1-22, P2-22 Bypass Pruners/P6 and P7 Left-Handed Pruners



**R202P/R271P**



P1-22, P2-22 1 R202P

Spare Centre Bolt/Nut/Washer Set for Pruners



**R239P/R141P/R142P/R157H**

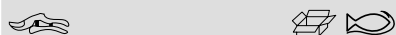

P34-27A, P3-20, P3-23, P5-20, P5-23, P108-20, P108-23, P110-20, P110-23 24 R142P  
P121-23 1 R148V  
P1-20, P1-22, P2-20, P2-22, P6-20, P7-20 1 R239P

Spare Counter Blades and Pins for Hand-Pruners



**R113PG/R123PG**



P108-20, P110-20 30 R113PG  
P108-23, P110-23 30 R123PG

Spare Closing Springs



**R341P/R474P**

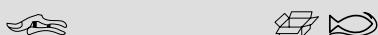

P3-20, P3-23 12 R341P  
P5-20, P5-23, P108-20, P108-23, P110-20, P110-23 1 R474P

Spare Springs for One-Hand Pruners

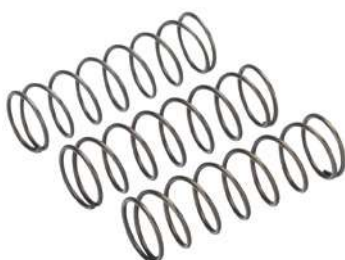

**R438P/R463P**

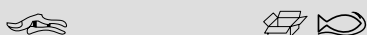

P121-20 1 R434P  
P121-20 50 R434P-BULK50  
P121-23 1 R463P  
P138-22 1 R438P  
P138-22 50 R438P-BULK50

Spare Spring and Buffer Set for One-Hand Pruners



**R1069P**

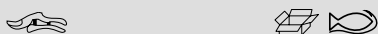

P1-20, P2-20, P6-20, P7-20 12 R1069P

Spare Springs, Buffers and Buffer Cup Set for One-Hand Pruners



**R1068**



P3-20, P3-23, P5-20, P5-23, P108-20, P108-23, P110-20, P110-23 1 R1068

Spare Part Kit for P5-20 and P5-23 Re-Designed Secateurs



**R1080P**

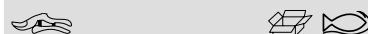

P5-20, P5-23 1 R1080P

Spare Handle Screws/Nuts/Closing Button Set with Flat Spring for Pruners



**R1601**

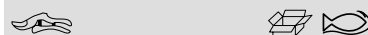

P1-20, P1-22, P2-20, P6-20, P7-20 1 R1601



Spare Locking Device with Screws and Nuts for P108 and P5 Bypass Secateurs



**R478P/R480P**

|      |   |       |
|------|---|-------|
|      |   |       |
| P108 | 1 | R478P |
| P5   | 1 | R480P |

Straight Short Snips with Fibreglass Handle



**P128**

|      |    |                |
|------|----|----------------|
|      |    |                |
| 6 mm | 6  | P128-19        |
| 6 mm | 30 | P128-19-BULK30 |

**LOPPERS**

30 mm Professional Lightweight Bypass Loppers with Aluminium Handle



**P114-SL**

|       |        |   |            |
|-------|--------|---|------------|
|       |        |   |            |
| 30 mm | 400 mm | 2 | P114-SL-40 |
| 30 mm | 500 mm | 2 | P114-SL-50 |
| 30 mm | 600 mm | 2 | P114-SL-60 |

**FRUIT PICKING TOOLS**

Bypass Snips with Fibreglass Handle



**P123**

|       |    |                |
|-------|----|----------------|
|       |    |                |
| 10 mm | 30 | P123-19-BULK30 |

11° Angled Snips with Fibreglass Handle



**P129**

|      |    |                |
|------|----|----------------|
|      |    |                |
| 6 mm | 30 | P129-19-BULK30 |

30 mm Professional Bypass Loppers with Steel Handle and Forged Counter Blade



**P16**

|       |        |   |          |
|-------|--------|---|----------|
|       |        |   |          |
| 30 mm | 400 mm | 2 | P16-40   |
| 30 mm | 500 mm | 2 | P16-50-F |
| 30 mm | 600 mm | 2 | P16-60-F |

Straight Long Snips with Fibreglass Handle



**P127**

|      |    |                |
|------|----|----------------|
|      |    |                |
| 6 mm | 30 | P127-19-BULK30 |

Spare Springs with Buffers for Snips



**R1071/R1075**

|                        |       |    |              |
|------------------------|-------|----|--------------|
|                        |       |    |              |
| P123, P127, P128, P129 | 20 g  | 14 | R1071        |
| P123, P127, P128, P129 | 130 g | 50 | R1075-BULK50 |

30 mm Professional Bypass Loppers with Wooden Handle and Forged Counter Blade



**P16-40W**

|       |        |   |         |
|-------|--------|---|---------|
|       |        |   |         |
| 30 mm | 400 mm | 2 | P16-40W |

35 mm Professional Lightweight Bypass Loppers with Aluminium Handle



**P116-SL**

| Blade Width | Length (L) | Quantity | Part Number |
|-------------|------------|----------|-------------|
| 35 mm       | 400 mm     | 2        | P116-SL-40  |
| 35 mm       | 500 mm     | 2        | P116-SL-50  |
| 35 mm       | 600 mm     | 2        | P116-SL-60  |
| 35 mm       | 700 mm     | 2        | P116-SL-70  |

45 mm Professional Lightweight Long Bypass Loppers with Aluminium Handle and Forged Counter Blade



**P160-SL**

| Blade Width | Length (L) | Quantity | Part Number |
|-------------|------------|----------|-------------|
| 45 mm       | 600 mm     | 2        | P160-SL-60  |
| 45 mm       | 750 mm     | 1        | P160-SL-75  |
| 45 mm       | 900 mm     | 1        | P160-SL-90  |

50 mm Professional Bypass Loppers with Aluminium Handle



**P19**

| Blade Width | Length (L) | Quantity | Part Number |
|-------------|------------|----------|-------------|
| 50 mm       | 800 mm     | 1        | P19-80-F    |

55 mm Professional Lightweight Long Bypass Loppers with Aluminium Handle



**P280-SL**

| Blade Width | Length (L) | Quantity | Part Number |
|-------------|------------|----------|-------------|
| 55 mm       | 600 mm     | 2        | P280-SL-60  |
| 55 mm       | 800 mm     | 2        | P280-SL-80  |

Professional Anvil Loppers with Lever Action and Aluminium Handle



**P173-SL**

| Blade Width | Length (L) | Quantity | Part Number |
|-------------|------------|----------|-------------|
| 45 mm       | 850 mm     | 1        | P173-SL-85  |

35 mm Bypass Loppers with Steel Handle



**P130-P140**

| Blade Width | Length (L) | Quantity | Part Number |
|-------------|------------|----------|-------------|
| 40 mm       | 450 mm     | 6        | P130-F      |
| 40 mm       | 660 mm     | 6        | P140-F      |

40 mm Expert Bypass Loppers with Dual-Component Handle



**PG-18**

| Blade Width | Length (L) | Quantity | Part Number |
|-------------|------------|----------|-------------|
| 40 mm       | 450 mm     | 2        | PG-18-45-F  |
| 40 mm       | 610 mm     | 2        | PG-18-60-F  |

40 mm Expert Bypass Telescopic Loppers with Dual-Component Handle



**PG-19**

| Blade Width | Length (L)   | Quantity | Part Number |
|-------------|--------------|----------|-------------|
| 40 mm       | 700 - 900 mm | 2        | PG-19-F     |

Spare Cutting Blades for Loppers



**R114V/R373A**

| Blade Width    | Quantity | Part Number  |
|----------------|----------|--------------|
| P160-SL        | 28       | R160A-BULK28 |
| P280-SL-80     | 25       | R185V        |
| P14            | 25       | R114V        |
| P14            | 28       | R114V-BULK28 |
| P280           | 1        | R181P        |
| P-SL2, P116-SL | 1        | R16V         |
| P-SL2, P116-SL | 14       | R16V-BULK14  |
| P-SL, P114-SL  | 8        | R115V        |
| P-SL, P114-SL  | 14       | R115V-BULK14 |
| P16            | 1        | R116V        |
| P16            | 36       | R116V-BULK36 |
| P19-80         | 1        | R119V        |
| P160           | 1        | R160A        |
| P173-SL-85     | 25       | R373A        |



## Spare Counter Blades for Loppers



### R214V/R26V/R260A/...

| Icon          | Icon | Icon         |
|---------------|------|--------------|
| P14           | 1    | R214V        |
| P14           | 28   | R214V-BULK28 |
| P116-SL       | 8    | R216SL       |
| P-SL-40/45/60 | 1    | R215V        |
| P114-SL       | 1    | R214SL       |
| P160          | 16   | R260A        |
| P16*          | 40   | R716VCB      |
| P180-70       | 1    | R680V        |
| P19-80        | 1    | R619V        |

## Spare Buffers for Loppers and Hedge Shears



### R430V-R516V

| Icon                                    | Icon | Icon  |
|---|------|-------|
| P-SL, P-SL2, P114, P116, P52-SL, P54-SL | 22   | R440V |

## Spare Anvils with Screws for Loppers



### R372H

| Icon                  | Icon | Icon  |
|-----------------------|------|-------|
| P172-65 /-85, P172-SL | 1    | R372H |

## Spare Central Bolt and Nut Set for Loppers



### R312V-R318V/R143PV/R144PV/R146

| Icon                  | Icon | Icon          |
|-----------------------|------|---------------|
| P280-SL               | 12   | R335V         |
| P16                   | 1    | R143PV        |
| P16*                  | 1    | R143PVCB      |
| P160                  | 24   | R144PV        |
| P14, P174, P176-75    | 24   | R146VS        |
| P14, P174, P176-75    | 50   | R146VS-BULK50 |
| P114-SL, P116-SL      | 22   | R166V         |
| P172-65 /-85          | 1    | R312V         |
| P-SL-40 /-45 /-60     | 1    | R315V         |
| P280-(SL)             | 22   | R328V         |
| P180-70, P19-80, P172 | 1    | R318V         |

## Spare Handle Bolt and Nut Set for Loppers



### R415V-R775V

| Icon                    | Icon | Icon  |
|-------------------------|------|-------|
| P280-SL                 | 1    | R775V |
| P173-SL-85              | 1    | R776V |
| P-SL, P-SL2, P114, P116 | 1    | R415V |
| P19-80                  | 1    | R519V |
| P14, P16                | 1    | R615V |
| P160                    | 24   | R660V |
| P172-SL                 | 14   | R772V |
| P280-SL-80              | 1    | R773V |

## Hexagonal Screws for Adjusting Blade to Anvil



### R272H

| Icon                    | Icon | Icon  |
|-------------------------|------|-------|
| P173-SL-85              | 30   | R472H |
| P172-65/-85, P172-SL-85 | 1    | R272H |

## POLE SAWS & TOP PRUNERS

### Telescopic aluminium poles



### ATP-200

| Icon         | Icon | Icon        |
|--------------|------|-------------|
| 2000-3520 mm | 1    | ATP-200-350 |
| 2070-5040 mm | 1    | ATP-200-500 |

### Aluminium or Fibreglass Telescopic Poles



### AP-FP-

| Icon           | Icon | Icon  |
|----------------|------|-------|
| 2000 - 5000 mm | 1    | AP-5M |
| 2000 - 3500 mm | 1    | AP-3M |
| 1800 - 3200 mm | 1    | FP-3M |

### Aluminium Compact Telescopic Poles



### ATP-110-210

| Icon           | Icon | Icon        |
|----------------|------|-------------|
| 1100 - 2100 mm | 1    | ATP-110-210 |



Aluminium Base Section Poles



**ASP-1850G**



1870 mm



1 ASP-1850G



Adaptors for P34-37/P134/P34-27A-F Top Pruner



**ASP-ATP**



160 mm



100 g



6 ASP-ATP

Top Pruners with Triple Pulley Action



**P34-37**



40 mm



2 P34-37



Aluminium Extension Poles



**ASP-1850**



1870 mm



1 ASP-1850



Adaptor for section and telescopic poles



**RAUNI**



ATP-110-210



82 g



6 RAUNI

Top Pruners with Single Pulley Action



**P34-27A**



30 mm



2 P34-27A-F



Adaptors for Pole Saws



**ASP-AS**



135 mm



6 ASP-AS

Pole Hooks with Adaptor for ASP and ATP Poles



**ASP-AS-HOOK**



325 g



4 ASP-AS-HOOK



Top Pruners on Telescopic Pole



**ATP-230-410**



32 mm



2370 - 4110 mm



2 ATP-230-410



Top Pruners with Pull Cord



**AP-234**

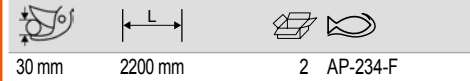

30 mm 2200 mm 2 AP-234-F

Top Pruner Set



**ASP3740-P**

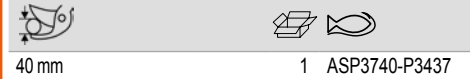

40 mm 1 ASP3740-P3437

ASP-1850G

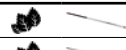

ASP-1850



P34-37



ASP-ATP



4750-PSTB-1



Spare cutting blades for top-pruners P34-37



**R137E**



P34-37 30 R137E

Spare Blade Kit for ATP-230-410 Telescopic Top Pruner

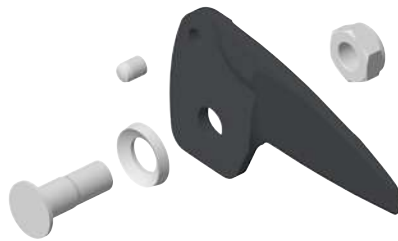

**R230P**



ATP-230-410 62 g 10 R230P

Spare Spring for ATP-230-410 Telescopic Top Pruner



**R4230**



ATP-230-410 7 g 10 R4230

Spare Rubber Bumper for Short Telescopic Pole



**RBCP**



ATP-110-210 30 g 10 RBCP

Spare Rubber Bumper & Inner Handle for Telescopic Top Pruner



**RBCP230**

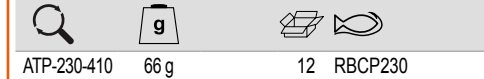

ATP-230-410 66 g 12 RBCP230

Spare Cam for ATP Telescopic Poles



**RCAM**



ATP-200-350 ; ATP-200-500 ; ATP-110-210 29 g 20 RCAM30  
ATP-200-500 ; ATP-110-210 37 g 20 RCAM36

Spare Rope for Cutting Head



**RD1M**



ATP-230-410 5 g 15 RD1M

Spare Centre Bolt and Nut Set for P34-37 Top Pruners



**R142P/R337E**

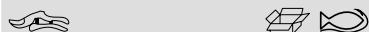

P34-37 1 R337E

Spare Lever for Cutting Head for ATP-230-410 Telescopic Top Pruner



**RPL230G**

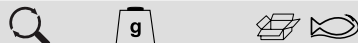

ATP-230-410 72 g 8 RPL230G

Medium Cut Pole Pruning Saws



**ASP-AS-C\_M**



360 mm 6.2 5 ASP-AS-C36-JT-M

Spare Rope for Cutting Head for ATP-230-410 Telescopic Top Pruner



**RD7M**



ATP-230-410 19 g 20 RD7M

Spare Springs for P34-27A Top Pruner



**R427AE/R427E/R437E**

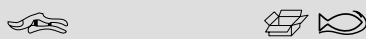

P134, P34-27A 18 R427AE  
P34-37 18 R437E

Coarse Cut Pole Pruning Saws



**ASP-AS-C\_C**



390 mm 5.4 5 ASP-AS-C39-JT-C  
450 mm 5.4 2 ASP-AS-C45-JT-C

Spare Counter Blades for Top-Pruners



**R133PG**

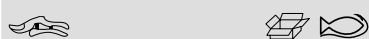

P34-27A 1 R133PG

Fine Cut Pole Pruning Saws



**ASP-AS-C\_F**

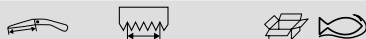

330 mm 7 5 ASP-AS-C33-JT-F

Hardpoint and Fileable Teeth Pole Pruning Saws with Plastic Handle



**339-/340-**

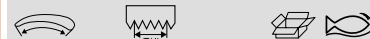

360 mm 6 4 339-6T  
360 mm 6 4 340-6T



Hardpoint and Fileable Teeth Pole Pruning Saws with Steel Tube Handle



**383-/384-**

| Length | Teeth | Quantity | Model  |
|--------|-------|----------|--------|
| 360 mm | 6     | 4        | 383-6T |
| 360 mm | 6     | 4        | 384-6T |
| 360 mm | 5     | 4        | 384-5T |

Pole Saws Set with 390 mm Coarse Cut Blade



**ASP3740-C39JTC**

| L       | g      | Quantity | Model          |
|---------|--------|----------|----------------|
| 1950 mm | 2838 g | 1        | ASP3740-C39JTC |

|                 |  |
|-----------------|--|
| ASP-1850G       |  |
| ASP-1850        |  |
| ASP-AS-C39-JT-C |  |
| 4750-PSTB-1     |  |

Heavy Duty Lightweight Hedge Shears with Aluminium Handle



**P51-SL**

| L      | Quantity | Model  |
|--------|----------|--------|
| 570 mm | 2        | P51-SL |

Hardpoint and Fileable Teeth Pole Pruning Saws with Steel Tube Handle and Extended Hook Tip



**385-/386-**

| Length | Teeth | Quantity | Model  |
|--------|-------|----------|--------|
| 360 mm | 6     | 4        | 385-6T |
| 360 mm | 6     | 4        | 386-6T |

Pole Saws Set with 450 mm Coarse Cut Blade



**ASP3740-C45JTC**

| L       | g      | Quantity | Model          |
|---------|--------|----------|----------------|
| 1950 mm | 2863 g | 1        | ASP3740-C45JTC |

|                 |  |
|-----------------|--|
| ASP-1850G       |  |
| ASP-1850        |  |
| ASP-AS-C45-JT-C |  |
| 4750-PSTB-1     |  |

Heavy Duty Extra Long Lightweight Hedge Shears with Aluminium Handle



**P51H-SL**

| L      | Quantity | Model   |
|--------|----------|---------|
| 730 mm | 2        | P51H-SL |

Pole Saws Set with 360 mm Medium Cut Blade



**ASP3740-C36JTM**

| L       | g      | Quantity | Model          |
|---------|--------|----------|----------------|
| 1950 mm | 2819 g | 1        | ASP3740-C36JTM |

|                 |  |
|-----------------|--|
| ASP-1850G       |  |
| ASP-1850        |  |
| ASP-AS-C36-JT-M |  |
| 4750-PSTB-1     |  |

**HEDGE SHEARS**

Heavy Duty Lightweight Hedge Shears with Steel Handle



**P51**

| L      | Quantity | Model |
|--------|----------|-------|
| 570 mm | 2        | P51-F |

Heavy Duty Hedge Shears with Wooden Handle



**P57-25**

| L      | Quantity | Model    |
|--------|----------|----------|
| 540 mm | 4        | P57-25-F |

Lightweight Precision Hedge Shears with Aluminium Handle



**P54-SL**

|        |         |   |           |
|--------|---------|---|-----------|
|        |         |   |           |
| 550 mm | 22.5 cm | 2 | P54-SL-25 |

Precision Hedge Shears with Aluminium Handle



**PG-56**

|        |       |   |         |
|--------|-------|---|---------|
|        |       |   |         |
| 540 mm | 23 cm | 2 | PG-56-F |

Spare Buffers for Hedge Shears



**R440V-R516V**

|   |    |        |
|---|----|--------|
|   |    |        |
| P14, P16, P180-70, P19-80, P160-60, P51 | 22 | R515VS |
| P160, P160-SL, P280-SL                  | 22 | R516V  |
| P53-SL, P54H-SL, P52-SL-20              | 22 | R444V  |

Long Lightweight Precision Hedge Shears with Aluminium Handle



**P54H-SL**

|        |         |   |            |
|--------|---------|---|------------|
|        |         |   |            |
| 650 mm | 22.5 cm | 2 | P54H-SL-25 |

Expert Telescopic Hedge Shears with Aluminium Handle



**PG-57-F**

|             |       |   |         |
|-------------|-------|---|---------|
|             |       |   |         |
| 800-1050 mm | 20 cm | 2 | PG-57-F |

Centre Bolt/Nut/Locking Ring Set for Hedge Shears



**R146VC/R147V**

|                                     |    |        |
|-------------------------------------|----|--------|
|                                     |    |        |
| P51, P51H, P52, P53, P54, P52-SL-20 | 22 | R146VC |
| P55, P57                            | 24 | R147V  |

Lightweight Extra Precision Hedge Shears with Aluminium Handle



**P52-SL-20**

|        |       |   |           |
|--------|-------|---|-----------|
|        |       |   |           |
| 590 mm | 18 cm | 2 | P52-SL-20 |

Universal Hedge Shears with Steel Handle



**P59**

|        |       |   |          |
|--------|-------|---|----------|
|        |       |   |          |
| 580 mm | 21 cm | 6 | P59-25-F |

**GRASS SHEARS**

3-Positions Grass Shears with Plastic Sleeve Handle



**GS-76**

|        |       |   |       |
|--------|-------|---|-------|
|        |       |   |       |
| 355 mm | 435 g | 8 | GS-76 |





Multi-Angle Grass Shear



**GS-180**

|        |       |   |          |
|--------|-------|---|----------|
|        |       |   |          |
| 375 mm | 317 g | 6 | GS-180-F |

Duck's Foot Grass Shears with Plastic Sleeve Handle 1100 mm



**P74**

|         |        |   |     |
|---------|--------|---|-----|
|         |        |   |     |
| 1100 mm | 2000 g | 1 | P74 |

Grass Shears with Plastic Sleeve Handle 1000 mm



**P75**

|         |        |   |     |
|---------|--------|---|-----|
|         |        |   |     |
| 1000 mm | 1900 g | 1 | P75 |

### PRUNING KNIVES

Foldable Grafting Knives with Plastic Handle



**P11**

|        |      |   |     |
|--------|------|---|-----|
|        |      |   |     |
| 180 mm | 70 g | 6 | P11 |

Foldable Pruning Knives with Plastic Handle



**P20**

|        |       |   |     |
|--------|-------|---|-----|
|        |       |   |     |
| 190 mm | 100 g | 6 | P20 |

Bow-Shaped Foldable Pruning Knives with Stainless Steel Handle



**K-AP-1**

|      |    |        |
|------|----|--------|
|      |    |        |
| 90 g | 10 | K-AP-1 |

Hook-Shaped Foldable Pruning Knives with Stainless Steel Handle



**K-GP-1**

|      |    |        |
|------|----|--------|
|      |    |        |
| 90 g | 10 | K-GP-1 |

### SCISSORS

Floral Scissor with Soft Touch Finger Loop - Small



**FS-5**

|    |      |
|----|------|
|    |      |
| 10 | FS-5 |

Floral Scissor with Soft Touch Finger Loop - Medium



**FS-8**

|    |      |
|----|------|
|    |      |
| 10 | FS-8 |

Floral Scissor with Soft Touch Finger Loop - Large



**FS-7.5**



10 FS-7.5

## BOW SAWS

ERGO™ Heavy Duty Professional Bow Saws 21"-30"



ergo



**10**



|        |       |   |          |
|--------|-------|---|----------|
| 530 mm | 21 in | 5 | 10-21-51 |
| 607 mm | 24 in | 5 | 10-24-23 |
| 607 mm | 24 in | 5 | 10-24-51 |
| 759 mm | 30 in | 5 | 10-30-23 |
| 759 mm | 30 in | 5 | 10-30-51 |

ERGO™ Pointed Heavy Duty Professional Bow Saws 21"



ergo



**332**



|        |       |   |           |
|--------|-------|---|-----------|
| 530 mm | 21 in | 5 | 332-21-51 |
|--------|-------|---|-----------|

General Purpose Bow Saws 21" to 36"



**SE -15-16**



|        |       |   |             |
|--------|-------|---|-------------|
| 530 mm | 21 in | 5 | SE-16-21    |
| 530 mm | 21 in | 5 | SE-16-21-23 |
| 607 mm | 24 in | 5 | SE-15-24    |
| 759 mm | 30 in | 5 | SE-15-30    |
| 759 mm | 30 in | 5 | SE-15-30-23 |
| 810 mm | 32 in | 5 | SE-15-32    |
| 912 mm | 36 in | 5 | SE-15-36    |
| 912 mm | 36 in | 5 | SE-15-36-23 |

Pointed Bow Saws for Dry Wood 21"



**331-21**



|        |       |   |              |
|--------|-------|---|--------------|
| 530 mm | 21 in | 5 | 331-21-51-KP |
|--------|-------|---|--------------|

Pointed Bow Saws for Green Wood 15"



**331-15**



|        |       |   |           |
|--------|-------|---|-----------|
| 378 mm | 15 in | 5 | 331-15-23 |
|--------|-------|---|-----------|

General Purpose Bow Saws with Reversible Blade 24"



**3-24-51**



|        |       |   |         |
|--------|-------|---|---------|
| 607 mm | 24 in | 5 | 3-24-51 |
|--------|-------|---|---------|

General Purpose Bow Saws with Reversible Blade 21"



**2-21-51**



|        |       |   |         |
|--------|-------|---|---------|
| 530 mm | 21 in | 5 | 2-21-51 |
|--------|-------|---|---------|

General Purpose Bow Saws with Reversible Blade 14"



**333**



|        |       |   |     |
|--------|-------|---|-----|
| 350 mm | 14 in | 5 | 333 |
|--------|-------|---|-----|



Bow Saws for Ventilation Tubes 24"



**14-24**

|        |       |   |            |
|--------|-------|---|------------|
|        |       |   |            |
| 607 mm | 24 in | 5 | 14-24-3810 |

Green Wood Spare Blades for Bow Saw 15"-36"



**23**

|        |          |    |       |
|--------|----------|----|-------|
|        |          |    |       |
| 378 mm | 13.33 in | 10 | 23-15 |
| 530 mm | 20.75 in | 10 | 23-21 |
| 607 mm | 24 in    | 10 | 23-24 |
| 759 mm | 30 in    | 10 | 23-30 |
| 810 mm | 28.57 in | 10 | 23-32 |
| 912 mm | 36 in    | 10 | 23-36 |

Foldable Pruning Saws with Low Friction Blade



**PG-72**

|        |   |   |       |
|--------|---|---|-------|
|        |   |   |       |
| 190 mm | 7 | 4 | PG-72 |

Toolbox-Sized Mini Bow Saw 12"



**9-12**

|        |       |   |                 |
|--------|-------|---|-----------------|
|        |       |   |                 |
| 320 mm | 12 in | 5 | 9-12-51/3806-KP |

Fine Peg Toothed Spare Blades for Bow Saw 14"



**333-5**

|        |           |    |       |
|--------|-----------|----|-------|
|        |           |    |       |
| 350 mm | 13-3/4 in | 10 | 333-5 |

Foldable Pruning Saws with Dual-Component Handle for Dry Wood/Plastic/Bone Cutting



**396-LAP**

|        |       |     |              |
|--------|-------|-----|--------------|
|        |       |     |              |
| 190 mm | 200 g | 10  | 396-LAP      |
| 190 mm | 44 g  | 100 | 396-BLADE    |
| 190 mm | 44 g  | 1   | 396-BLADE-1P |

Dry Wood Spare Blades for Bow Saw 12"-36"



**51**

|        |           |    |       |
|--------|-----------|----|-------|
|        |           |    |       |
| 320 mm | 12-1/2 in | 10 | 51-12 |
| 530 mm | 20.75 in  | 10 | 51-21 |
| 607 mm | 24 in     | 10 | 51-24 |
| 759 mm | 30 in     | 10 | 51-30 |
| 810 mm | 28.57 in  | 10 | 51-32 |
| 912 mm | 36 in     | 10 | 51-36 |

**PRUNING SAWS**

Toothed Handheld Pruning Saws with Low Friction Blade



**349**

|        |   |   |     |
|--------|---|---|-----|
|        |   |   |     |
| 300 mm | 7 | 4 | 349 |

Foldable Pruning Saws with Dual-Component Handle for Green Branches Cutting



**396-JS**

|        |   |   |        |
|--------|---|---|--------|
|        |   |   |        |
| 190 mm | 5 | 4 | 396-JS |

Foldable Pruning Saws with Dual-Component Handle for Winter Pruning



**396-JT**



|        |   |   |        |
|--------|---|---|--------|
|        |   |   |        |
| 190 mm | 7 | 4 | 396-JT |

Handheld Pruning Saws with Dual-Component Handle and Holster for Green Branches Cutting



**51-JS**



|        |   |   |           |
|--------|---|---|-----------|
|        |   |   |           |
| 240 mm | 5 | 4 | 5124-JS-H |
| 280 mm | 5 | 4 | 5128-JS-H |

Spare Blades for 51-JS Pruning Saws



**5724-JS/5728-JS**

|        |   |   |         |
|--------|---|---|---------|
|        |   |   |         |
| 240 mm | 5 | 1 | 5724-JS |
| 280 mm | 5 | 1 | 5728-JS |

Foldable Pruning Saws with Dual-Component Handle for Hard/Dry Wood Cutting



**396-HP**



|        |   |   |        |
|--------|---|---|--------|
|        |   |   |        |
| 190 mm | 7 | 4 | 396-HP |

Pruning Saws with Dual-Component Handle and Holster for Winter Pruning



**41-JT**



|        |   |   |           |
|--------|---|---|-----------|
|        |   |   |           |
| 240 mm | 7 | 4 | 4124-JT-H |
| 280 mm | 7 | 4 | 4128-JT-H |

Spare Blades for 41-JT Pruning Saws



**4724-JT/4728-JT**

|        |   |   |         |
|--------|---|---|---------|
|        |   |   |         |
| 240 mm | 7 | 1 | 4724-JT |
| 280 mm | 7 | 1 | 4728-JT |

4211 Hardpoint and 4212 Fileable Toothed Pruning Saws with Wooden Handle



**4211-4212-**



|        |   |   |            |
|--------|---|---|------------|
|        |   |   |            |
| 280 mm | 6 | 4 | 4211-11-6T |
| 360 mm | 6 | 4 | 4211-14-6T |
| 280 mm | 6 | 4 | 4212-11-6T |
| 360 mm | 6 | 4 | 4212-14-6T |

Foldable Saw and Knife Laplander Set with Dual-Component Handle



**LAP-KNIFE**



|       |    |           |
|-------|----|-----------|
|       |    |           |
| 329 g | 10 | LAP-KNIFE |

396-LAP  
2444-LAP

Spare Blades for 396-JS Pruning Saws



**396-JS-BLADE**

|        |   |     |              |
|--------|---|-----|--------------|
|        |   |     |              |
| 190 mm | 5 | 300 | 396-JS-BLADE |



Spare Blades for 396-JT Pruning Saws



**396-JT-BLADE**

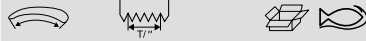

190 mm      7      300 396-JT-BLADE

Spare Blades for 396-HP Pruning Saws



**396-HP-BLADE**



190 mm      7      300 396-HP-BLADE

Spare Blades for 4211/4212/339/340 Pruning Saws



**4400-/4420-**



|        |   |    |              |
|--------|---|----|--------------|
| 280 mm | 6 | 10 | 4400-11      |
| 360 mm | 6 | 10 | 4400-14      |
| 280 mm | 6 | 10 | 4420-11      |
| 360 mm | 6 | 10 | 4420-14      |
| 280 mm | 6 | 10 | 4400-11-BULK |
| 360 mm | 6 | 10 | 4400-14-BULK |
| 280 mm | 6 | 10 | 4420-11-BULK |
| 360 mm | 6 | 10 | 4420-14-BULK |

**SPARE PARTS & ACCESSORIES**

Spare Fine Cut Curved Blades for Pole Saws



**AS-F-BLADE**



330 mm      7      15 AS-C33-JT-F

Spare Medium Cut Curved Blades for Pole Saws



**AS-M-BLADE**



360 mm      6.2      15 AS-C36-JT-M

Spare Coarse Cut Curved Blades for Pole Saws



**AS-C-C-BLADE**



390 mm      5.4      15 AS-C39-JT-C  
450 mm      5.4      15 AS-C45-JT-C

**ACCESSORIES & MAINTENANCE**

Synthetic Grinding Stones 180/400 Grain



**LS-COMBINESS**

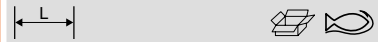

100 mm      1 LS-COMBINESS

Synthetic Grinding Stones 320 Grain



**LS-CORINDON**

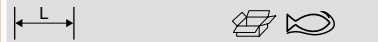

100 mm      1 LS-PIERRE CORINDON

Grinding Stones and Carbide Sharpener with Dual-Component Handle



**SHARP-X**

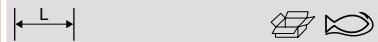

100 mm      10 SHARP-X  
100 mm      1 SHARP-X-DISP



Synthetic Grinding Stones 180 Grain



**LS-PIERRE-FAUX**



230 mm



1 LS-PIERRE-FAUX

Carbor Type Synthetic Grinding Stones  
220 Grain



**LS-6160-23**



230 mm



1 LS-6160-23

Lubricants 50 ml Spray Bottle



**LUB-2015**



60 g



6 LUB-2015





**BAHCO**



## Air Tools Outdoor



## SECATEURS

Professional Air Secateurs with Single Cutting Blade



**9210**



30 mm

1 9210

Cutting Blades and Rivets for 9210 Air Secateurs



**9210-1**



9210

82 g

1 9210-1

Complete Pre-Assembled Cutting Heads for 9210 Air Secateurs



**9210-10**



9210

212 g

1 9210-10

Pack of Assorted O-Rings for 9210 Air Secateurs



**9210-20**



9210

28 g

1 9210-20

Piston Discs for 9210 Air Secateurs



**9210-1690148**

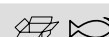

9210

22 g

1 9210-1690148

Brass Sleeves for 9210 Air Secateurs - 10 Pcs



**9210-1720100**



9210

55.3 g

1 9210-1720100

Shock Absorbers for 9210 Air Secateurs



**9210-1730107**



9210

176 g

10 9210-1730107

Piston Seals for 9210 Air Secateurs



**9210-1230235**



9210

6.7 g

1 9210-1230235

Return Springs for 9210 Air Secateurs



**9210-1640142**



9210

26.6 g

1 9210-1640142

Connecting Rods for 9210 Air Secateurs



**9210-1700118**



9210 41 g 1 9210-1700118

TSP 2.2 mm x 6.5 mm Self Tapping Screws for 9210 Air Secateurs



**9210-1060238**



9210 10 g 20 9210-1060238

TCCE M6 x 20 mm Screws for 9210 Air Secateurs



**9210-1060177**

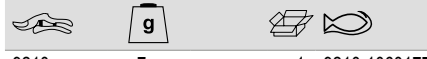

9210 7 g 1 9210-1060177

Special Rivets for 9210 Air Secateurs



**9210-1770106**



9210 1000 g 10 9210-1770106

Front Covers for 9210 Air Secateurs



**9210-1830137**



9210 9.5 g 1 9210-1830137

Hand Guards for 9210 Air Secateurs



**9210-1320281**



9210 35 g 10 9210-1320281

Dust Protection Seals for 9210 Air Secateurs



**9210-1230219**



9210 8.6 g 20 9210-1230219

Secateurs Body with Brass Cylinder for 9210 Air Secateurs



**9210-1710266**



9210 193 g 1 9210-1710266







**BAHCO**



**Lindström**

## PRECISION CUTTERS

### DIAGONAL CUTTERS

ERGO™ Precision Diagonal Cutters with Oval Head



ergo®



#### RX 8130-RX 8162

| 0.00-0.04 / 0.2-1.0  | Micro-Bevel® | 10 | RX 8130 |
|----------------------|--------------|----|---------|
| 0.00-0.04 / 0.1-1.0  | Flush        | 10 | RX 8131 |
| 0.00-0.03 / 0.1-0.8  | Ultra-Flush® | 10 | RX 8132 |
| 0.00-0.05 / 0.2-1.25 | Micro-Bevel® | 10 | RX 8140 |
| 0.00-0.05 / 0.1-1.25 | Flush        | 10 | RX 8141 |
| 0.00-0.04 / 0.1-1.0  | Ultra-Flush® | 10 | RX 8142 |
| 0.01-0.06 / 0.3-1.6  | Micro-Bevel® | 10 | RX 8150 |
| 0.00-0.06 / 0.2-1.6  | Flush        | 10 | RX 8151 |
| 0.00-0.05 / 0.2-1.25 | Ultra-Flush® | 10 | RX 8152 |
| 0.02-0.08 / 0.4-2.0  | Micro-Bevel® | 10 | RX 8160 |
| 0.01-0.08 / 0.3-2.0  | Flush        | 10 | RX 8161 |
| 0.01-0.06 / 0.3-1.6  | Ultra-Flush® | 10 | RX 8162 |

Precision Diagonal Cutters with Oval Head & ESD Safe Handle



#### 8130-8162

| 0.01-0.04 / 0.2-1.0  | Micro-Bevel® | 10 | 8130    |
|----------------------|--------------|----|---------|
| 0.00-0.04 / 0.1-1.0  | Flush        | 10 | 8131    |
| 0.00-0.03 / 0.1-0.8  | Ultra-Flush® | 10 | 8132    |
| 0.01-0.05 / 0.2-1.25 | Micro-Bevel® | 10 | 8140    |
| 0.00-0.05 / 0.1-1.25 | Flush        | 10 | 8141    |
| 0.00-0.04 / 0.1-1.0  | Ultra-Flush® | 10 | 8142    |
| 0.01-0.06 / 0.3-1.6  | Micro-Bevel® | 10 | 8150    |
| 0.01-0.06 / 0.2-1.6  | Flush        | 10 | 8151    |
| 0.00-0.05 / 0.1-1.25 | Ultra-Flush® | 10 | 8152    |
| 0.02-0.08 / 0.4-2.0  | Micro-Bevel® | 10 | 8160    |
| 0.01-0.08 / 0.3-2.0  | Flush        | 10 | 8161    |
| 0.01-0.08 / 0.3-1.6  | Ultra-Flush® | 10 | 8162    |
| 0.00-0.04 / 0.1-1.0  | Flush        | 10 | 8131 CO |
| 0.01-0.05 / 0.2-1.25 | Micro-Bevel® | 10 | 8140 CO |
| 0.00-0.05 / 0.1-1.25 | Flush        | 10 | 8141 CO |
| 0.00-0.04 / 0.1-1.0  | Ultra-Flush® | 10 | 8142 CO |
| 0.01-0.06 / 0.3-1.6  | Micro-Bevel® | 10 | 8150 CO |
| 0.01-0.06 / 0.2-1.6  | Flush        | 10 | 8151 CO |
| 0.02-0.08 / 0.4-2.0  | Micro-Bevel® | 10 | 8160 CO |
| 0.01-0.08 / 0.3-2.0  | Flush        | 10 | 8161 CO |

Long Precision Diagonal Cutters with Oval Head & ESD Safe Handle



#### HS 8130-HS 8162

| 0.2-1.25 mm | Micro-Bevel® | 1  | HS 8130 |
|-------------|--------------|----|---------|
| 0.1-1.25 mm | Flush        | 1  | HS 8131 |
| 0.1-1.0 mm  | Ultra-Flush® | 1  | HS 8132 |
| 0.2-1.25 mm | Micro-Bevel® | 10 | HS 8140 |
| 0.1-1.25 mm | Flush        | 10 | HS 8141 |
| 0.1-1.0 mm  | Ultra-Flush® | 10 | HS 8142 |
| 0.3-1.6 mm  | Micro-Bevel® | 1  | HS 8150 |
| 0.2-1.6 mm  | Flush        | 10 | HS8151  |
| 0.1-1.25 mm | Ultra-Flush® | 10 | HS8152  |
| 0.4-2.0 mm  | Micro-Bevel® | 10 | HS 8160 |
| 0.3-2.0 mm  | Flush        | 10 | HS 8161 |
| 0.3-2.0 mm  | Ultra-Flush® | 10 | HS 8162 |

ERGO™ Precision Diagonal Cutters with Tapered Head



ergo®



#### RX 8133-RX 8165

| 0.008-0.04 / 0.2-1.0 | Micro-Bevel® | 10 | RX8133  |
|----------------------|--------------|----|---------|
| 0.004-0.03 / 0.1-0.8 | Flush        | 10 | RX8134  |
| 0.004-0.02 / 0.1-0.5 | Ultra-Flush® | 10 | RX8135  |
| 0.01-0.05 / 0.2-1.25 | Micro-Bevel® | 10 | RX 8143 |
| 0.00-0.05 / 0.1-1.25 | Flush        | 10 | RX 8144 |
| 0.00-0.04 / 0.1-1.0  | Ultra-Flush® | 10 | RX 8145 |
| 0.01-0.06 / 0.3-1.6  | Micro-Bevel® | 10 | RX 8153 |
| 0.01-0.06 / 0.2-1.6  | Flush        | 10 | RX 8154 |
| 0.01-0.05 / 0.2-1.25 | Ultra-Flush® | 10 | RX8155  |
| 0.02-0.08 / 0.4-2.0  | Micro-Bevel® | 10 | RX8163  |
| 0.01-0.08 / 0.3-2.0  | Flush        | 10 | RX 8164 |
| 0.01-0.06 / 0.3-1.6  | Ultra-Flush® | 10 | RX 8165 |

Precision Diagonal Cutters with Tapered Head



#### 8133-8165

| 0.008-0.04 / 0.2-1.0 | Micro-Bevel® | 10 | 8133    |
|----------------------|--------------|----|---------|
| 0.004-0.03 / 0.1-0.8 | Flush        | 10 | 8134    |
| 0.004-0.02 / 0.1-0.5 | Ultra-Flush® | 10 | 8135    |
| 0.01-0.05 / 0.2-1.25 | Micro-Bevel® | 10 | 8143    |
| 0.01-0.05 / 0.2-1.25 | Flush        | 10 | 8144    |
| 0.00-0.04 / 0.1-1.0  | Ultra-Flush® | 10 | 8145    |
| 0.01-0.06 / 0.3-1.6  | Micro-Bevel® | 10 | 8153    |
| 0.01-0.06 / 0.2-1.6  | Flush        | 10 | 8154    |
| 0.01-0.05 / 0.2-1.25 | Ultra-Flush® | 10 | 8155    |
| 0.02-0.08 / 0.4-2.0  | Micro-Bevel® | 10 | 8163    |
| 0.01-0.08 / 0.3-2.0  | Flush        | 10 | 8164    |
| 0.01-0.06 / 0.3-1.6  | Ultra-Flush® | 10 | 8165    |
| 0.01-0.05 / 0.2-1.25 | Flush        | 10 | 8144 CO |
| 0.01-0.06 / 0.2-1.6  | Flush        | 10 | 8154 CO |
| 0.02-0.08 / 0.4-2.0  | Micro-Bevel® | 10 | 8163 CO |
| 0.01-0.06 / 0.3-1.6  | Ultra-Flush® | 10 | 8165 CO |

Diagonal Cutters with Tapered Head & ESD Safe Handle



#### 7190-7191

| 0.00-0.04 / 0.2-1.0 | Micro-Bevel® | 10 | 7190    |
|---------------------|--------------|----|---------|
| 0.00-0.04 / 0.1-1.0 | Flush        | 10 | 7191    |
| 0.00-0.04 / 0.2-1.0 | Micro-Bevel® | 10 | 7190 CO |
| 0.00-0.04 / 0.1-1.0 | Flush        | 10 | 7191 CO |

Long Precision Diagonal Cutters with Tapered Head & ESD Safe Handle



**HS 8133-HS 8165**

| Head Type    | Handle Type | Quantity | Model   |
|--------------|-------------|----------|---------|
| Micro-Bevel® |             | 1        | HS8133  |
| Flush        |             | 1        | HS8134  |
| Ultra-Flush® |             | 1        | HS8135  |
| Micro-Bevel® |             | 10       | HS 8143 |
| Flush        |             | 10       | HS 8144 |
| Ultra-Flush® |             | 10       | HS 8145 |
| Micro-Bevel® |             | 10       | HS8153  |
| Flush        |             | 10       | HS8154  |
| Ultra-Flush® |             | 1        | HS8155  |
| Micro-Bevel® |             | 10       | HS 8163 |
| Flush        |             | 10       | HS 8164 |
| Ultra-Flush® |             | 10       | HS8165  |

Long Diagonal Cutters with Tapered Head & ESD Safe Handle



**HS 7190-HS 7191**

| Head Type    | Handle Type | Quantity | Model  |
|--------------|-------------|----------|--------|
| Micro-Bevel® |             | 1        | HS7190 |
| Flush        |             | 1        | HS7191 |

ERGO™ Precision Diagonal Cutters with Tapered & Relieved Head



**RX 8136-RX 8168**

| Head Type    | Handle Type | Quantity | Model   |
|--------------|-------------|----------|---------|
| Micro-Bevel® |             | 10       | RX8136  |
| Flush        |             | 10       | RX 8137 |
| Ultra-Flush® |             | 10       | RX8138  |
| Micro-Bevel® |             | 10       | RX 8146 |
| Flush        |             | 10       | RX 8147 |

Precision Diagonal Cutters with Tapered Head & Relieved & ESD Safe Handle



**8136-8168**

| Head Type    | Handle Type | Quantity | Model   |
|--------------|-------------|----------|---------|
| Micro-Bevel® |             | 10       | 8136    |
| Flush        |             | 10       | 8137    |
| Ultra-Flush® |             | 10       | 8138    |
| Micro-Bevel® |             | 10       | 8146    |
| Flush        |             | 10       | 8147    |
| Ultra-Flush® |             | 10       | 8148    |
| Micro-Bevel® |             | 10       | 8156    |
| Flush        |             | 10       | 8157    |
| Ultra-Flush® |             | 10       | 8158    |
| Micro-Bevel® |             | 10       | 8166L   |
| Flush        |             | 10       | 8167L   |
| Ultra-Flush® |             | 10       | 8168L   |
| Ultra-Flush® |             | 10       | 8148 CO |

Long Precision Diagonal Cutters with Tapered & Relieved Head & ESD Safe Handle



**HS 8136-HS 8168**

| Head Type    | Handle Type | Quantity | Model  |
|--------------|-------------|----------|--------|
| Micro-Bevel® |             | 1        | HS8136 |
| Flush        |             | 1        | HS8137 |
| Ultra-Flush® |             | 1        | HS8138 |
| Micro-Bevel® |             | 10       | HS8146 |
| Flush        |             | 10       | HS8147 |

| Head Type    | Handle Type | Quantity | Model   |
|--------------|-------------|----------|---------|
| Ultra-Flush® |             | 10       | HS 8148 |
| Micro-Bevel® |             | 1        | HS8156  |
| Flush        |             | 1        | HS8157  |
| Ultra-Flush® |             | 1        | HS8158  |
| Micro-Bevel® |             | 1        | HS8166  |
| Flush        |             | 1        | HS8167  |
| Ultra-Flush® |             | 1        | HS8168  |

**DIAGONAL CUTTERS, UNIQUE HEAD**

ERGO™ Precision Diagonal Cutters with Tapered & Relieved Head



**RX8137MX-RX8138MX**

| Head Type    | Handle Type | Quantity | Model    |
|--------------|-------------|----------|----------|
| Flush        |             | 10       | RX8137MX |
| Ultra-Flush® |             | 10       | RX8138MX |

**OBLIQUE - END CUTTERS**

Precision 11° Oblique End Cutters 0.35 mm-1.25 mm



**7290-7291**

| Head Type    | Handle Type | Quantity | Model |
|--------------|-------------|----------|-------|
| Micro-Bevel® |             | 10       | 7290  |
| Flush        |             | 10       | 7291  |

Long Precision 11° Angled Oblique End Cutters 0.35 mm-1.25 mm



**HS 7290-HS 7291**

|                      |              |   |        |
|----------------------|--------------|---|--------|
|                      |              |   |        |
| 0.01-0.03 / 0.35-0.8 | Micro-Bevel® | 1 | HS7290 |
| 0.01-0.03 / 0.35-0.8 | Flush        | 1 | HS7291 |

Precision Oblique End Cutters with Miniature Head



**7292**

|                  |       |    |      |
|------------------|-------|----|------|
|                  |       |    |      |
| 0.01-0.03 / 0.35 | Flush | 10 | 7292 |

Long Precision Oblique End Cutters with Miniature Head



**HS 7292**

|                      |       |    |        |
|----------------------|-------|----|--------|
|                      |       |    |        |
| 0.01-0.03 / 0.35-0.8 | Flush | 10 | HS7292 |

Precision 11° Angled Oblique End Cutters 0.35 mm-1 mm



**7293**

|                      |       |    |      |
|----------------------|-------|----|------|
|                      |       |    |      |
| 0.01-0.03 / 0.35-0.8 | Flush | 10 | 7293 |

Long Precision 11° Angled Oblique End Cutters 0.35 mm-1 mm



**HS 7293**

|                      |       |   |        |
|----------------------|-------|---|--------|
|                      |       |   |        |
| 0.01-0.04 / 0.35-1.0 | Flush | 1 | HS7293 |

Long Precision 20° Short Head Oblique Cutters 0.2 mm-1.2 mm



**HS 8211**

|                     |       |    |        |
|---------------------|-------|----|--------|
|                     |       |    |        |
| 0.01-0.05 / 0.2-1.2 | Flush | 10 | HS8211 |

**ANGLE**

ERGO™ Short Precision 20° Head Oblique Cutters 0.2 mm-1.2 mm



**ergo**



ERGO™ Long Precision 45° Tapered Head Oblique Cutters 0.2 mm-1 mm



**ergo**



**RX 8247**

|                     |       |    |         |
|---------------------|-------|----|---------|
|                     |       |    |         |
| 0.01-0.04 / 0.2-1.0 | Flush | 10 | RX 8247 |

**RX 8211**

|                     |       |    |         |
|---------------------|-------|----|---------|
|                     |       |    |         |
| 0.01-0.05 / 0.2-1.2 | Flush | 10 | RX 8211 |

Short Precision 20° Head Oblique Cutters 0.2 mm-1.2 mm



**8211**

|                     |       |    |      |
|---------------------|-------|----|------|
|                     |       |    |      |
| 0.01-0.05 / 0.2-1.2 | Flush | 10 | 8211 |

Precision 45° Head Oblique Cutters 0.2 mm-1 mm



**8247**

|                     |       |    |         |
|---------------------|-------|----|---------|
|                     |       |    |         |
| 0.01-0.04 / 0.2-1.0 | Flush | 10 | 8247    |
| 0.01-0.04 / 0.2-1.0 | Flush | 10 | 8247 CO |



Long Precision 45° Tapered Head Oblique Cutters 0.2 mm-1 mm



**HS 8247**

|                     |       |  |           |
|---------------------|-------|--|-----------|
|                     |       |  | 1 HS 8247 |
| 0.01-0.04 / 0.2-1.0 | Flush |  |           |

ERGO™ Long Precision 45° Tapered & Relieved Head Oblique Cutters 0.2 mm-0.8 mm



ergo



**RX 8248**

|                     |       |  |            |
|---------------------|-------|--|------------|
|                     |       |  | 10 RX 8248 |
| 0.01-0.03 / 0.2-0.8 | Flush |  |            |

Precision 45° Oblique Cutters 0.2 mm-1 mm



**7285**

|            |       |  |         |
|------------|-------|--|---------|
|            |       |  | 10 7285 |
| 0.2-1.0 mm | Flush |  |         |

Long Precision 45° Tapered & Relieved Head Oblique Cutters 0.2 mm-0.8 mm



**HS 8248**

|                     |       |  |            |
|---------------------|-------|--|------------|
|                     |       |  | 10 HS 8248 |
| 0.01-0.03 / 0.2-0.8 | Flush |  |            |

Precision 45° Oblique Cutters 0.2 mm-0.8 mm



**7280**

|                     |       |  |         |
|---------------------|-------|--|---------|
|                     |       |  | 10 7280 |
| 0.01-0.03 / 0.2-0.8 | Flush |  |         |

Long Precision 45° Oblique Cutters 0.2 mm-1 mm



**HS 7285**

|                     |       |  |          |
|---------------------|-------|--|----------|
|                     |       |  | 1 HS7285 |
| 0.01-0.04 / 0.2-1.0 | Flush |  |          |

Long Precision 45° Tapered & Relieved Head Oblique Cutters 0.2 mm-0.8 mm



**8248**

|                     |       |  |            |
|---------------------|-------|--|------------|
|                     |       |  | 10 8248    |
| 0.01-0.03 / 0.2-0.8 | Flush |  |            |
|                     |       |  | 10 8249    |
| 0.00-0.03 / 0.2-0.8 | Flush |  |            |
|                     |       |  | 10 8248 CO |
| 0.01-0.03 / 0.2-0.8 | Flush |  |            |

Long Precision Reverse Oblique Cutters 0.2 mm-0.8 mm



**HS 7280**

|                     |       |  |          |
|---------------------|-------|--|----------|
|                     |       |  | 1 HS7280 |
| 0.01-0.03 / 0.2-0.8 | Flush |  |          |

**PLASTIC CUTTERS**

ERGO™ Precision Diagonal Plastic Cutters



ergo



**P6160**

|        |       |  |          |
|--------|-------|--|----------|
|        |       |  | 10 P6160 |
| 1.5 mm | Flush |  |          |

## TIP CUTTER

ERGO™ Precision Diagonal Tip Cutters



ergo



**RX 8149**

|                     |       |    |         |
|---------------------|-------|----|---------|
|                     |       |    |         |
| 0.01-0.02 / 0.1-0.6 | Flush | 10 | RX 8149 |

Precision Diagonal Tip Cutters with ESD Safe Handle



**8149**

|                     |       |    |      |
|---------------------|-------|----|------|
|                     |       |    |      |
| 0.00-0.02 / 0.1-0.6 | Flush | 10 | 8149 |

Long Precision Diagonal Tip Cutters with ESD Safe Handle



**HS 8149**

|                     |       |   |        |
|---------------------|-------|---|--------|
|                     |       |   |        |
| 0.01-0.02 / 0.1-0.6 | Flush | 1 | HS8149 |

## OBLIQUE CUTTERS, UNIQUE HEAD

Long Precision 45° Tapered & Relieved Head Oblique Cutters 0.2 mm-0.8 mm



**8248Q**

|                     |              |    |       |
|---------------------|--------------|----|-------|
|                     |              |    |       |
| 0.00-0.03 / 0.2-0.8 | Ultra-Flush® | 10 | 8248Q |

Precision Oblique End Cutters with Miniature Head



**7292G**

|                  |       |    |       |
|------------------|-------|----|-------|
|                  |       |    |       |
| 0.01-0.03 / 0.35 | Flush | 10 | 7292G |

## MICRO TIP CUTTERS

ERGO™ Precision Micro Tip Cutters 149 mm



ergo



**RX 8233**

|                       |       |    |         |
|-----------------------|-------|----|---------|
|                       |       |    |         |
| 0.004-0.024 / 0.1-0.6 | Flush | 10 | RX8233A |

ERGO™ Precision Micro Tip Cutters 141 mm



ergo



**RX 8234**

|                        |       |    |         |
|------------------------|-------|----|---------|
|                        |       |    |         |
| 0.002-0.018 / 0.05-0.4 | Flush | 10 | RX8234A |

ERGO™ Precision Micro Tip Cutters 144 mm



ergo



**RX 8237**

|                      |       |    |         |
|----------------------|-------|----|---------|
|                      |       |    |         |
| 0.004-0.02 / 0.1-0.5 | Flush | 10 | RX8237A |

## MULTIPURPOSE SHEARS

Multipurpose Shear with Non-Slip Grips



**HS6000**

|        |       |    |        |
|--------|-------|----|--------|
|        |       |    |        |
| Kevlar | Flush | 10 | HS6000 |
| Kevlar | Flush | 10 | HS6001 |

## ACCESSORIES & SPARE PARTS

Lead Catchers for 8130 & 8140 Series Diagonal Cutters



### 813/814/816

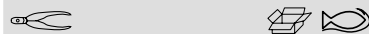

|                         |   |     |
|-------------------------|---|-----|
| 8130-8132, Rx 8130-8132 | 1 | 813 |
| 8140-8148, Rx 8140-8148 | 1 | 814 |
| 8130-8132, 8140-8148    | 1 | 816 |

Return Springs for RX Series



### RX 01



|    |   |       |
|----|---|-------|
| 5g | 1 | RX 01 |
|----|---|-------|

Return Springs for 80, Supreme and HS Series



### 8130-50/8160

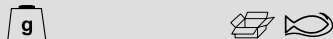

|    |   |                     |
|----|---|---------------------|
| 1g | 1 | 8130-50/SUPR SPRING |
| 1g | 1 | 8160/SPRING         |

## PRECISION CUTTERS FOR HARD MATERIALS

### CARBIDE CUTTERS

Precision Carbide Diagonal Cutters with Tapered Head for Hard Materials



### 7154 TC



|            |            |    |        |
|------------|------------|----|--------|
| 0.1-0.9 mm | 0.1-0.4 mm | 10 | 7154TC |
|------------|------------|----|--------|

## PERFORMANCE SPECIFIC DIAGONAL CUTTERS

ERGO™ Precision Performance Specific Diagonal Cutters with Oval Head



ergo



### RX 8140PS-RX 8161PS



|                     |              |    |           |
|---------------------|--------------|----|-----------|
| 0.01-0.04 / 0.1-1.0 | Micro-Bevel® | 10 | RX8140PS  |
| 0.01-0.04 / 0.1-1.0 | Flush        | 10 | RX8141PS  |
| 0.01-0.04 / 0.1-1.0 | Micro-Bevel® | 10 | RX 8142PS |
| 0.01-0.04 / 0.1-1.0 | Micro-Bevel® | 10 | RX8150PS  |
| 0.01-0.06 / 0.3-1.6 | Flush        | 10 | RX 8161PS |

### EXTRA HARDENED DIAGONAL CUTTERS

ERGO™ Precision Extra Hardened Diagonal Cutters with Oval Head



ergo



### RX 8140M2-8160M2



|                     |              |    |          |
|---------------------|--------------|----|----------|
| 0.01-0.05 / 0.4-2.0 | Micro-Bevel® | 10 | RX8140M2 |
| 0.01-0.06 / 0.4-2.0 | Micro-Bevel® | 10 | RX8150M2 |
| 0.02-0.08 / 0.4-2.0 | Micro-Bevel® | 10 | RX8160M2 |

Precision Performance Specific Diagonal Cutters with Oval Head & ESD Safe Handle for hard materials



### 8140PS-8161PS



|                      |              |    |        |
|----------------------|--------------|----|--------|
| 0.01-0.04 / 0.1-1.0  | Micro-Bevel® | 10 | 8140PS |
| 0.01-0.04 / 0.1-1.0  | Flush        | 10 | 8141PS |
| 0.00-0.05 / 0.1-1.25 | Micro-Bevel® | 10 | 8150PS |
| 0.01-0.06 / 0.3-1.6  | Micro-Bevel® | 10 | 8160PS |
| 0.01-0.06 / 0.3-1.6  | Flush        | 10 | 8161PS |

Precision Extra Hardened Diagonal Cutters with Oval Head & ESD Safe Handle for hard materials



### 8140M2-8160M2



|                     |              |    |         |
|---------------------|--------------|----|---------|
| 0.01-0.05 / 0.4-2.0 | Micro-Bevel® | 10 | 8140M2  |
| 0.01-0.06 / 0.4-2.0 | Micro-Bevel® | 10 | 8150M2  |
| 0.02-0.08 / 0.4-2.0 | Micro-Bevel® | 10 | 8160 M2 |

ERGO™ Precision Diagonal Cutters with Tapered Head & ESD Safe Handle for hard materials



ergo



### RX8143PS-RX 8147PS



|                      |       |    |           |
|----------------------|-------|----|-----------|
| 0.01-0.04 / 0.1-1.0  | Flush | 10 | RX8143PS  |
| 0.004-0.03 / 0.1-0.8 | Flush | 10 | RX 8147PS |

**PERFORMANCE SPECIFIC DIAGONAL CUTTERS, UNIQUE HEAD**

ERGO™ Precision Performance Specific Diagonal Cutters with Oval Head



**RX8140PSF-RX8160BPS**

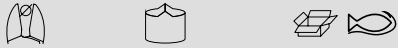

0.01-0.04 / 0.1-1.0 Micro-Bevel® 10 RX8160BPS

Precision Performance Specific Diagonal Cutters with Oval Head



**8154PSP**

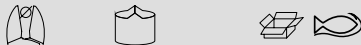

0.00-0.05 in Micro-Bevel® 10 8154PSP

**PRECISION HOLDING PLIERS**

**FLAT NOSE**

Flat Nose Pliers with Dual-Component Synthetic Handle



**7490**

|       |   |    |         |
|-------|---|----|---------|
|       |   |    |         |
| 20 mm | S | 10 | 7490    |
| 20 mm | S | 10 | 7490 CO |

ERGO™ Precision Flat Nose Pliers with Dual-Component Synthetic Handle



**RX 7490**

|       |   |    |         |
|-------|---|----|---------|
|       |   |    |         |
| 20 mm | S | 10 | RX 7490 |

Long Flat Nose Pliers with Dual-Component Synthetic Handle



**HS 7490**

|   |  |    |        |
|---|--|----|--------|
|   |  |    |        |
| S |  | 10 | HS7490 |

**ROUND NOSE**

ERGO™ Precision Round Nose Pliers with Dual-Component Synthetic Handle



**RX 7590**

|       |   |    |         |
|-------|---|----|---------|
|       |   |    |         |
| 20 mm | S | 10 | RX 7590 |

Round Nose Tipped Pliers with Synthetic Handle



**7590-7591**

|         |   |    |         |
|---------|---|----|---------|
|         |   |    |         |
| 20 mm   | S | 10 | 7590    |
| 20 mm   | S | 10 | 7590 CO |
| 38.5 mm | M | 1  | 7591    |

Long Round Nose Pliers with Synthetic Handle



**HS 7590**

|   |  |           |
|---|--|-----------|
|   |  |           |
| S |  | 1 HS 7590 |

## CHAIN NOSE

ERGO™ 60° Bent Tip Snipe Nose Pliers with Dual-Component Synthetic Handle



### RX 7892

|       |   |    |         |
|-------|---|----|---------|
|       |   |    |         |
| 29 mm | M | 10 | RX 7892 |

## Long Snipe Nose Pliers with Dual-Component Synthetic Handle



### HS 7890-HS 7891

|   |    |         |
|---|----|---------|
|   |    |         |
| M | 1  | HS 7890 |
| M | 10 | HS 7891 |

## BENT NOSE

60° Bent Tip Snipe Nose Pliers with Synthetic Handle



### 7892

|       |   |    |         |
|-------|---|----|---------|
|       |   |    |         |
| 20 mm | M | 10 | 7892    |
| 20 mm | M | 10 | 7892 CO |

ERGO™ Snipe Nose Pliers with Dual-Component Synthetic Handle



### RX 7890-RX 7891

|       |   |    |         |
|-------|---|----|---------|
|       |   |    |         |
| 32 mm | S | 10 | RX 7890 |
| 32 mm | S | 10 | RX 7891 |

## CHAINMAILLE PLIER

ERGO™ Precision Chainmaille Flat Straight Nose Stubby Pliers with Synthetic Handle



### RX 7390

|       |   |    |         |
|-------|---|----|---------|
|       |   |    |         |
| 11 mm | S | 10 | RX 7390 |

Long 60° Bent Tip Snipe Nose Pliers with Synthetic Handle



### HS 7892

|   |   |         |
|---|---|---------|
|   |   |         |
| M | 1 | HS 7892 |

Snipe Nose Pliers with Dual-Component Synthetic Handle



### 7890-7891

|         |   |    |         |
|---------|---|----|---------|
|         |   |    |         |
| 32.5 mm | M | 10 | 7890    |
| 32.5 mm | M | 10 | 7891    |
| 32.5 mm | M | 10 | 7890 CO |
| 32.5 mm | M | 10 | 7891 CO |

ERGO™ Precision Chainmaille Flat Oblique Nose Stubby Pliers with Synthetic Handle



### RX 7392

|       |   |    |         |
|-------|---|----|---------|
|       |   |    |         |
| 12 mm | S | 10 | RX 7392 |

## SHOULDER NOSE

ERGO™ Short Snipe Nose Pliers with Dual-Component Synthetic Handle



### RX 7893

|       |   |    |         |
|-------|---|----|---------|
|       |   |    |         |
| 20 mm | S | 10 | RX 7893 |



Short Snipe Nose Pliers with Synthetic Handle



**7893**

|       |   |    |      |
|-------|---|----|------|
|       |   |    |      |
| 20 mm | S | 10 | 7893 |

Long Short Snipe Nose Pliers with Synthetic Handle



**HS 7893**

|   |   |         |
|---|---|---------|
|   |   |         |
| S | 1 | HS 7893 |

**SNIPE NOSE, UNIQUE HEAD**

Short Snipe Nose Pliers with Synthetic Handle



**7893K**

|       |   |    |       |
|-------|---|----|-------|
|       |   |    |       |
| 20 mm | S | 10 | 7893K |

**NEEDLE NOSE**

ERGO™ Precision Needle Nose Holding Pliers with smooth Jaws



**ergo**



**RX 7894**

|   |    |         |
|---|----|---------|
|   |    |         |
| L | 10 | RX 7894 |

Long Needle Nose Pliers with Synthetic Handle



**HS 7894**

|   |   |         |
|---|---|---------|
|   |   |         |
| L | 1 | HS 7894 |

Precision Needle Nose Holding Pliers with smooth Jaws & ESD Safe Handle



**7894**

|   |    |      |
|---|----|------|
|   |    |      |
| L | 10 | 7894 |

**SHEAR CUTTERS**

**TAPERED HEAD**

Micro Edge Shear Cutter with Tapered Head



**6151**

|            |         |           |    |      |
|------------|---------|-----------|----|------|
|            |         |           |    |      |
| Micro Edge | 0.2-1.6 | 0.01-0.06 | 10 | 6151 |

Flush Edge Shear Cutter with Tapered Head



**6152**

|            |         |           |    |      |
|------------|---------|-----------|----|------|
|            |         |           |    |      |
| Flush Edge | 0.2-1.6 | 0.01-0.06 | 10 | 6152 |

Stainless Steel Flush Edge Shear Cutter with Tapered Head



**6152SS**

|            |         |           |    |        |
|------------|---------|-----------|----|--------|
|            |         |           |    |        |
| Flush Edge | 0.2-1.6 | 0.01-0.06 | 10 | 6152SS |

## POINTY HEAD

Flush Edge Shear Cutter with Pointy Head



**6159**



|            |                    |    |      |
|------------|--------------------|----|------|
|            |                    |    |      |
| Flush Edge | 0.2-1.0/0.01-0.039 | 10 | 6159 |

## OBLIQUE HEAD

Flush Edge Shear Cutter with Oblique Head



**6258**



|            |                    |    |      |
|------------|--------------------|----|------|
|            |                    |    |      |
| Flush Edge | 0.2-1.0/0.01-0.039 | 10 | 6258 |

## PRECISION SCREWDRIVERS

### ESD SAFE

Slotted ESD Safe Precision Screwdrivers 1.5-3.0 mm



**800ESD**

|        |       |    |               |
|--------|-------|----|---------------|
|        |       |    |               |
| 1.5 mm | 50 mm | 10 | 800-1.5-50ESD |
| 2.0 mm | 50 mm | 10 | 800-2-50ESD   |
| 2.5 mm | 50 mm | 10 | 800-2.5-50ESD |
| 3.0 mm | 50 mm | 10 | 800-3-50ESD   |

Phillips ESD Safe Precision Screwdrivers PH00-PH1



**801ESD**

|      |       |    |              |
|------|-------|----|--------------|
|      |       |    |              |
| PH00 | 50 mm | 10 | 801-00-50ESD |
| PH0  | 50 mm | 10 | 801-0-50ESD  |
| PH1  | 75 mm | 10 | 801-1-75ESD  |

TORX® ESD Safe Precision Screwdrivers T6-T20



**803ESD**

|     |       |    |              |
|-----|-------|----|--------------|
|     |       |    |              |
| T6  | 50 mm | 10 | 803-6-50ESD  |
| T7  | 50 mm | 10 | 803-7-50ESD  |
| T8  | 50 mm | 10 | 803-8-50ESD  |
| T9  | 50 mm | 10 | 803-9-50ESD  |
| T10 | 50 mm | 10 | 803-10-50ESD |
| T15 | 75 mm | 10 | 803-15-75ESD |
| T20 | 75 mm | 10 | 803-20-75ESD |

Pentalobe ESD Safe Precision Screwdrivers TS1-TS5



**805ESD**

|     |       |    |               |
|-----|-------|----|---------------|
|     |       |    |               |
| TS1 | 50 mm | 10 | 805-TS1-50ESD |
| TS4 | 50 mm | 10 | 805-TS4-50ESD |
| TS5 | 50 mm | 10 | 805-TS5-50ESD |

Slotted/Phillips ESD Safe Precision Screwdriver Set 1.5-3.0mm/PH00-PH1 - 7 Pcs



**801-7ESD**

|   |   |          |
|---|---|----------|
|   |   |          |
| 7 | 1 | 801-7ESD |

800-1.5-50ESD, 800-2-50ESD, 800-2.5-50ESD, 800-3-50ESD

801-00-50ESD, 801-0-50ESD, 801-1-75ESD

TORX® ESD Safe Precision Screwdriver Set T6-T20 - 7 Pcs



**803-7ESD**

|   |   |          |
|---|---|----------|
|   |   |          |
| 7 | 1 | 803-7ESD |

803-6-50ESD, 803-7-50ESD, 803-8-50ESD, 803-9-50ESD, 803-10-50ESD, 803-15-75ESD, 803-20-75ESD

▶ WIRE STRIPPERS

DIAGONAL CUTTERS

Precision Diagonal Cutters with Oval Head - Stripping Accessory & ESD Safe Handle



**8150SK**

|                     |              |    |         |
|---------------------|--------------|----|---------|
|                     |              |    |         |
| 0.01-0.06 / 0.3-1.6 | Micro-Bevel® | 10 | 8150 SK |

Precision Diagonal Wire Strippers & Cutters with Oval Head & ESD Safe Handle



**8150J-8160J**

|               |              |    |        |
|---------------|--------------|----|--------|
|               |              |    |        |
| 0.02 / 0.5    | Micro-Bevel® | 10 | 8150 J |
| Max0.02 / Max | Micro-Bevel® | 10 | 8160 J |

▶ HEAVY DUTY CUTTERS

DIAGONAL CUTTER

Heavy Duty Diagonal Cutters with Dual-Component Handle



**TRX 8180**

|        |        |   |          |
|--------|--------|---|----------|
|        |        |   |          |
| 4.5 mm | 2.5 mm | 5 | TRX 8180 |



▶ TORQUE TOOLS

TORQUE SCREWDRIVERS

Adjustable Torque Screwdrivers with Window Scale and ESD Safe



**MA500-1A - MA500-3A**

|            |        |   |          |
|------------|--------|---|----------|
|            |        |   |          |
| 16-80 cNM  | 1/4 in | 1 | MA500-1A |
| 40-200 cNM | 1/4 in | 1 | MA500-2A |
| 90-450 cNM | 1/4 in | 1 | MA500-3A |

Pre-Set Torque Screwdrivers with Window Scale and ESD Safe



**PS501**

|            |        |   |         |
|------------|--------|---|---------|
|            |        |   |         |
| 4-22 cNM   | 1/4 in | 1 | PS501-1 |
| 7-70 cNM   | 1/4 in | 1 | PS501-2 |
| 15-170 cNM | 1/4 in | 1 | PS501-3 |
| 45-450 cNM | 1/4 in | 1 | PS501-4 |

## TWEEZERS

### TWEEZER SETS

Set of 5 Tweezers Tip Style SS-SA, 2A-SA, 7A-SA, AA-SA



**9855**



10 x 200 x 110 mm



1 9855

9855W

TL SS-SA-SL

TL AA-SA-SL

TL 2A-SA-SL

TL 7A-SA-SL

TL 4-SA-SL

Set of 5 Tweezers Tip Style 00-SA, 1-SA, 3C-SA, 5-SA, 7-SA



**9857**



10 x 200 x 110 mm



1 9857

TL 00-SA-SL

TL 1-SA-SL

TL 5-SA-SL

TL 7-SA-SL

TL 3C-SA-SL

9855W

Set of 2 Tweezers Tip Style AA-SA, SS-SA



**9858**



8 x 200 x 65 mm



1 9858

9858W

TL AA-SA-SL

TL SS-SA-SL

Set of 2 Tweezers Tip Style 00B-SA, 2A-SA



**9859**



8 x 200 x 65 mm



1 9859

9858W

TL 00B-SA

TL 2A-SA-SL

Set of 5 High Precision Tweezers Tip Style 00-SA, 2A-SA, 3C-SA, 5-SA, 7-SA



**9860**



12 x 105 x 185 mm



1 9860

Set of 5 Economy Tweezers Tip Style 00-SA, 2A-SA, 3C-SA, 5-SA, 7-SA



**9861**



10 x 70 x 165 mm



1 9861

Set of 4 Economy Tweezers Tip Style 2A-SA, 3C-SA, 7A-SA, AA-SA



**9862**



10 x 70 x 165 mm



1 9862

Set of 5 SMD and Economy Tweezers Tip Style SM103-SA, SM108-SA, 3-SA, 5-SA, 7A-SA



**9863**



10 x 70 x 165 mm



1 9863

## CUTTING TWEEZERS

Carbon Steel Cutting Tweezers Style 15A with Angled Blades



### TL 15A



15A 120 mm 1 TL 15A

Carbon Steel Cutting Tweezers Style 15AGW with Predominantly Angled Blades



### TL 15AGW



15AGW 115 mm 1 TL 15AGW

Stainless Steel Cutting Tweezers Style 15AGWHM with Tungsten Carbide Inserts and Predominantly Angled Blades



### TL 15AGWHM-SA



15AGWHM 115 mm 1 TL 15AGWHM-SA

## HIGH PRECISION TWEEZERS

Stainless Steel High Precision Tweezers Style 00B with Serrated Handles and Thick, Strong tips



### TL 00B-SA

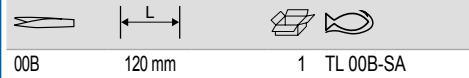

00B 120 mm 1 TL 00B-SA

Stainless steel, anti-magnetic, anti-acid

Stainless Steel High Precision Tweezers Style 00D with Serrated Handles and Thick, Strong, Linearly Serrated Tips



### TL 00D-SA

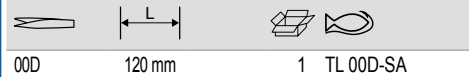

00D 120 mm 1 TL 00D-SA

Stainless steel, anti-magnetic, anti-acid

Stainless Steel High Precision Tweezers Style 00 with Thick and Strong Tips



### TL 00-SA

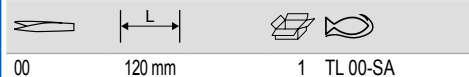

00 120 mm 1 TL 00-SA

Stainless steel, anti-magnetic, anti-acid

Stainless Steel High Precision Tweezers Style 000 with Fine Tips



### TL 000-SA

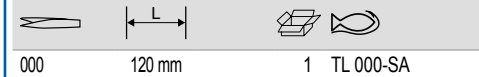

000 120 mm 1 TL 000-SA

Stainless Steel High Precision Tweezers Style 009 with Fine and Sharp Tips



### TL 009-SA

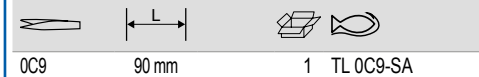

009 90 mm 1 TL 009-SA

Stainless steel, anti-magnetic, anti-acid

Stainless Steel High Precision Tweezers Style 1 with Fine and Sharp Tips



### TL 1-SA



1 120 mm 1 TL 1-SA

Stainless steel, anti-magnetic, anti-acid

Stainless Steel High Precision Tweezers Style 2A with Very Fine, Round and Flat Tips



### TL 2A-SA



2A 120 mm 1 TL 2A-SA

Stainless steel, anti-magnetic, anti-acid



Stainless Steel High Precision Tweezers  
Style 3C with Fine and Pointed Tips



**TL 3C-SA**

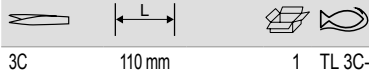

3C 110 mm 1 TL 3C-SA

Stainless steel, anti-magnetic, anti-acid

Stainless Steel High Precision Tweezers  
Style 3 with Fine and Pointed Tips



**TL 3-SA**

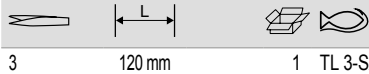

3 120 mm 1 TL 3-SA

Stainless steel, anti-magnetic, anti-acid

Stainless Steel High Precision Tweezers  
Style 51S with Bent and Very Fine Tips



**TL 51S-SA**

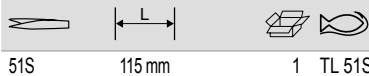

51S 115 mm 1 TL 51S-SA

Stainless steel, anti-magnetic, anti-acid

Stainless Steel High Precision Tweezers  
Style 5 with Very Fine Sharp Tips



**TL 5-SA**

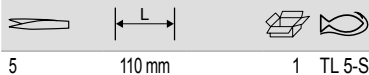

5 110 mm 1 TL 5-SA

Stainless steel, anti-magnetic, anti-acid

Stainless Steel High Precision Tweezers  
Style SS with Very Fine and Very Sharp  
Tips



**TL SS-SA**

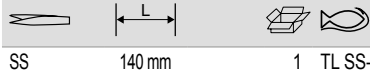

SS 140 mm 1 TL SS-SA

Stainless steel, anti-magnetic, anti-acid

Stainless Steel High Precision Tweezers  
Style 7A with Very Fine and Curved Tips



**TL 7A-SA**

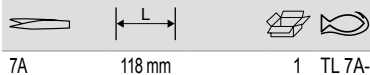

7A 118 mm 1 TL 7A-SA

Stainless steel, anti-magnetic, anti-acid

Stainless Steel High Precision Tweezers  
Style 7 with Very Fine and Curved Tips



**TL 7-SA**

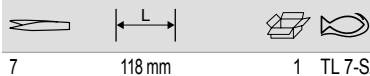

7 118 mm 1 TL 7-SA

Stainless steel, anti-magnetic, anti-acid

Stainless Steel High Precision Tweezers  
Style 5B with Bent, Very Fine Sharp Tips



**TL 5B-SA**



5B 110 mm 1 TL 5B-SA

Stainless steel, anti-magnetic, anti-acid

Stainless Steel High Precision Tweezers  
Style 65A with Bent, Very Fine and Very  
Sharp Tips



**TL 65A-SA**

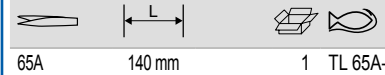

65A 140 mm 1 TL 65A-SA

Stainless steel, anti-magnetic, anti-acid

Stainless Steel High Precision Tweezers  
Style 34A with Serrated Handles and  
Smooth, Thin, Squared, Flat Tips



**TL 34A-SA**

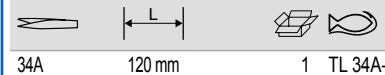

34A 120 mm 1 TL 34A-SA

Stainless Steel High Precision Tweezers  
Style 6 with Angled and Very Fine Tips



**TL 6-SA**



6 117 mm 1 TL 6-SA

## PLASTIC REPLACEABLE TIP TWEEZERS

Carbon Fibre Plastic Replaceable Tip ESD Safe Tweezers Style 242CFR with Fine Tips



### TL 242CFR-SA



242CFR 130 mm 1 TL 242CFR-SA

Carbon Fibre Plastic Replaceable Tip ESD Safe Tweezers Style 249CFR with Thick, Beveled and Strong Tips



### TL 249CFR-SA

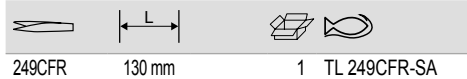

249CFR 130 mm 1 TL 249CFR-SA

Stainless steel body and carbon fibre tips

Carbon Fibre Plastic Replaceable Tip ESD Safe Tweezers Style 259CFR with Fine, Pointed and Strong Tips



### TL 259CFR-SA



259CFR 130 mm 1 TL 259 CFR-SA

Stainless steel body and carbon fibre tips

Carbon PEEK Plastic Replaceable Tip ESD Safe Tweezers Style 259CPR with Fine, Pointed and Strong Tips



### TL 259CPR-SA



259CPR 130 mm 1 TL 259CPR-SA

Carbon PEEK Plastic Replaceable Tip ESD Safe Tweezers Style 259CPR with Fine, Pointed and Strong Tips



### TL 259CPR-SA



259CPR 130 mm 1 TL 259CPR-SA

Carbon Fibre Plastic Replaceable Tip ESD Safe Tweezers Style 00CFR with Thick and Squared Tips



### TL 00CFR-SA



00CFR 130 mm 1 TL 00CFR-SA

Stainless steel body and carbon fibre tips

PVDF Plastic Replaceable Tip ESD Safe Tweezers Style 259SVR with Fine, Pointed and Strong Tips



### TL 259SVR-SA



259SVR 130 mm 1 TL 259SVR-SA

Carbon Fibre Plastic Replaceable Tip ESD Safe Tweezers Style 2ACFR with Very Fine and Round Flat Tips



### TL 2ACFR-SA



2ACFR 130 mm 1 TL 2ACFR-SA

Stainless steel body and carbon fibre tips

Carbon Fibre Plastic Replaceable Tip ESD Safe Tweezers Style 5CF with Very Fine and Sharp Tips



### TL 5CF-SA



5CF 130 mm 1 TL 5CF-SA

Carbon Fibre Plastic Replaceable Tip ESD Safe Tweezers Style 5CFR with Very Fine and Sharp Tips



### TL 5CFR-SA

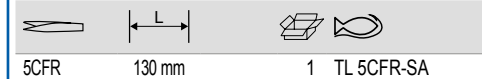

5CFR 130 mm 1 TL 5CFR-SA

Stainless steel body and carbon fibre tips

Carbon PEEK Plastic Replaceable Tip ESD Safe Tweezers Style 5CPR with Very Fine and Sharp Tips



### TL 5CPR-SA



5CPR 130 mm 1 TL 5CPR-SA

PVDF Plastic Replaceable Tip ESD Safe Tweezers Style 5SVR with Very Fine and Sharp Tips



### TL 5SVR-SA



5SVR 130 mm 1 TL 5SVR-SA

Carbon PEEK Plastic Replaceable Tip ESD Safe Tweezers Style 7CPR with Very Fine and Curved Tips



**TL 7CPR-SA**

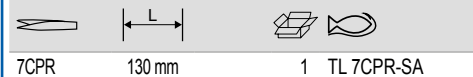

7CPR 130 mm 1 TL 7CPR-SA

PVDF Plastic Replaceable Tip ESD Safe Tweezers Style 7SVR with Very Fine and Curved Tips



**TL 7SVR-SA**



7SVR 130 mm 1 TL 7SVR-SA

Carbon Fibre Plastic Replaceable Tip ESD Safe Tweezers Style 7CFR with Very Fine and Curved Tips



**TL 7CFR-SA**



7CFR 130 mm 1 TL 7CFR-SA

Stainless steel body and carbon fibre tips

**ESD SAFE ERGONOMIC TOUCH TWEEZERS**

Stainless Steel ESD Safe Ergonomic Tweezers Style 00 with Thick and Strong Tips



**TL 00-SA-ET**

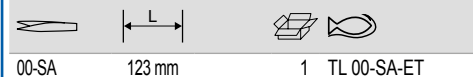

00-SA 123 mm 1 TL 00-SA-ET

Stainless Steel ESD Safe Ergonomic Tweezers Style 2A with Round, Flat and Very Fine Tips



**TL 2A-SA-ET**

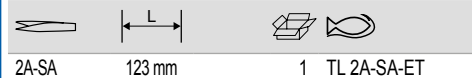

2A-SA 123 mm 1 TL 2A-SA-ET

Stainless Steel ESD Safe Ergonomic Tweezers Style 3 with Pointed and Fine Tips



**TL 3-SA-ET**

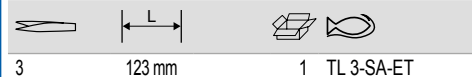

3 123 mm 1 TL 3-SA-ET

Stainless Steel ESD Safe Ergonomic Tweezers Style 3C with Pointed and Fine Tips



**TL 3C-SA-ET**

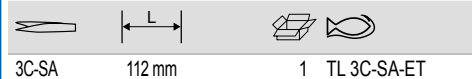

3C-SA 112 mm 1 TL 3C-SA-ET

Stainless Steel ESD Safe Ergonomic Tweezers Style 5 with Sharp and Fine Tips



**TL 5-SA-ET**



5-SA 112 mm 1 TL 5-SA-ET

Stainless Steel ESD Safe Ergonomic Tweezers Style AA with Sharp, Fine Tips



**TL AA-SA-ET**



AA-SA 130 mm 1 TL AA-SA-ET

Stainless Steel ESD Ergonomic Tweezers Style SM116 with Grooved Tips for Positioning Vertical Cylindrical Devices



**TL SM116-SA-ET**



SM116 115 mm 1 TL SM116-SA-ET

Stainless Steel ESD Safe Ergonomic Tweezers Style 7A with Curved and Fine Tips



**TL 7A-SA-ET**



7A 122 mm 1 TL 7A-SA-ET

Stainless Steel ESD Safe Ergonomic Tweezers Style 7 with Curved, Very Fine Tips



**TL 7-SA-ET**



7-SA 122 mm 1 TL 7-SA-ET

## ECONOMY TWEEZERS

Stainless Steel Economy Tweezers Style 00 with Thick and Strong Tips



**TL 00-SA-SL**

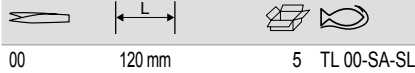

00 120 mm 5 TL 00-SA-SL

Stainless Steel Economy Tweezers Style 1 with Sharp and Fine Tips



**TL 1-SA-SL**

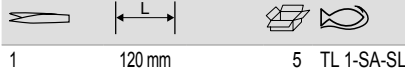

1 120 mm 5 TL 1-SA-SL

Stainless Steel Economy Tweezers Style 2A with Flat and Fine Round Tips



**TL 2A-SA-SL**

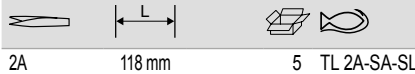

2A 118 mm 5 TL 2A-SA-SL

Stainless Steel Economy Tweezers Style 2 with Pointed and Very Fine Tips



**TL 2-SA-SL**



2 120 mm 5 TL 2-SA-SL

Stainless Steel Economy Tweezers Style 3C with Pointed and Fine Tips



**TL 3C-SA-SL**

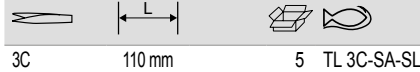

3C 110 mm 5 TL 3C-SA-SL

Stainless Steel Economy Tweezers Style 3 with Pointed and Fine Tips



**TL 3-SA-SL**



3 125 mm 5 TL 3-SA-SL

Stainless Steel Economy Tweezers Style 4 with Sharp and Fine Tips



**TL 4-SA-SL**

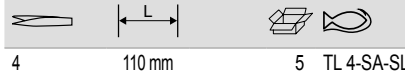

4 110 mm 5 TL 4-SA-SL

Stainless Steel Economy Tweezers Style 5A with Sharp and Fine Tips



**TL 5A-SA-SL**

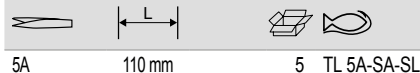

5A 110 mm 5 TL 5A-SA-SL

Stainless Steel Economy Tweezers Style 5A with Sharp and Fine Tips



**TL 5-SA-SL**

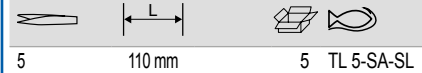

5 110 mm 5 TL 5-SA-SL

Stainless Steel Economy Tweezers Style AC with Serrated Handles and Strong Tips



**TL AC-SA-SL**

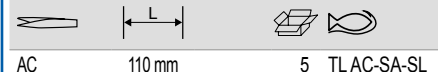

AC 110 mm 5 TL AC-SA-SL

Stainless Steel Economy Tweezers Style SS with Very Sharp and Fine Tips



**TL SS-SA-SL**

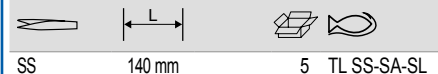

SS 140 mm 5 TL SS-SA-SL

Stainless Steel Economy Tweezers Style AA with Sharp and Fine Tips



**TL AA-SA-SL**



AA 128 mm 5 TL AA-SA-SL

Stainless Steel Economy Tweezers Style MM with Pointed, Strong and Fine Tips



**TL MM-SA-SL**



MM 125 mm 5 TL MM-SA-SL

Stainless Steel Economy Tweezers Style 7A with Curved and Fine Tips



**TL 7A-SA-SL**



7A 120 mm 5 TL 7A-SA-SL

Stainless Steel Economy Tweezers Style 7 with Curved and Fine Tips



**TL 7-SA-SL**



7 120 mm 5 TL 7-SA-SL

**SMD TWEEZERS**

Stainless Steel SMD Tweezers Style SMD 104 for Positioning SOT Packages and Monolithic Chip Capacitors



**TL SM104-SA**



SM104 120 mm 1 TL SM 104-SA

Stainless steel, anti-magnetic, anti-acid

Stainless Steel SMD Tweezers Style SMD 105 with Hammer Shaped Tips for Positioning Vertical SOT Packages



**TL SM105-SA**



SM105 120 mm 1 TL SM 105-SA

Stainless steel, anti-magnetic, anti-acid

Stainless Steel SMD Tweezers Style SMD 106 with Fine Shaped Tips for Positioning Horizontal SOT Packages



**TL SM106-SA**

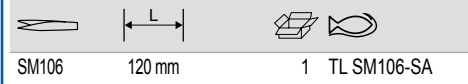

SM106 120 mm 1 TL SM106-SA

Stainless Steel SMD Tweezers Style SMD 108 for Soldering 1mm Wide Components



**TL SM108-SA**



SM108 120 mm 1 TL SM 108-SA

Stainless steel, anti-magnetic, anti-acid

Stainless Steel SMD Tweezers Style SMD 109 for Soldering 1mm Wide Components at 45° Angle



**TL SM109-SA**



SM109 120 mm 1 TL SM 109-SA

Stainless steel, anti-magnetic, anti-acid

Stainless Steel SMD Tweezers Style SMD 110 with Grooved Tips for Positioning Cylindrical Devices



**TL SM110-SA**



SM110 120 mm 1 TL SM 110-SA

Stainless steel, anti-magnetic, anti-acid

Stainless Steel SMD Tweezers Style SMD 111 with Grooved Tips for Positioning 0.5mm Cylindrical Devices



**TL SM111-SA**



SM111 115 mm 1 TL SM 111-SA

Stainless steel, anti-magnetic, anti-acid

Stainless Steel SMD Tweezers Style SMD 116 with Grooved Tips for Positioning Vertical Cylindrical Devices



**TL SM116-SA**



SM116 115 mm 1 TL SM116-SA

Stainless Steel SMD Tweezers Style SMD 107 with Double Bent Tips for Positioning Flat Devices



**TL SM107-SA**



SM107 120 mm 1 TL SM 107-SA

Stainless steel, anti-magnetic, anti-acid





Stainless Steel SMD Tweezers Style SMD 103 for Handling and Positioning at a 45° Angle



**TL SM103-SA**



SM103 115 mm 1 TL SM 103-SA

Stainless steel, anti-magnetic, anti-acid

Stainless Steel SMD Tweezers Style SMD 115 with 45° Angled Grooved Tips for Positioning 0.6mm Cylindrical Devices



**TL SM115-SA**



SM115 115 mm 1 TL SM 115-SA

Stainless steel, anti-magnetic, anti-acid

Stainless Steel SMD Tweezers Style SMD 117 with 20° Angled Squared Tips for Positioning SOT Packages



**TL SM117-SA**



SM117 120 mm 1 TL SM 117-SA

Stainless steel, anti-magnetic, anti-acid

**COMPONENTS POSITIONING TWEEZERS**

Stainless Steel Component Positioning Tweezers Style 578 with Serrated Handles and Grooved Tips for 2 mm Cylindrical Devices



**TL 578-SA**

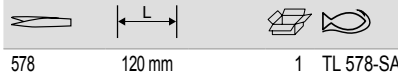

578 120 mm 1 TL 578-SA

Stainless steel, anti-magnetic, anti-acid

Stainless Steel Component Positioning Tweezers Style 582 with Serrated Handles and Grooved Tips for 1 mm Cylindrical Devices



**TL 582-SA**

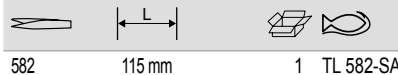

582 115 mm 1 TL 582-SA

Stainless steel, anti-magnetic, anti-acid

Stainless Steel General Purpose Tweezers Style 648 with Serrated Handles and Beveled, Thick, Strong, Sharp, Linearly Serrated Tips



**TL 648-SA**

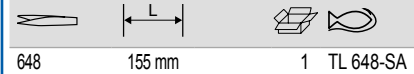

648 155 mm 1 TL 648-SA

Stainless steel, anti-magnetic, anti-acid

Stainless Steel General Purpose Tweezers Style 124 with Serrated Handles and Bent, Rhombic Serrated, Fine Tips



**TL 124-SA**

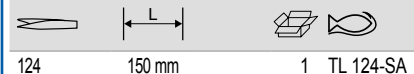

124 150 mm 1 TL 124-SA

Stainless steel, anti-magnetic, anti-acid

**GENERAL PURPOSE TWEEZERS**

Stainless Steel General Purpose Tweezers Style 475 with Serrated Handles and Beveled, Strong, Linearly Serrated Tips



**TL 475-SA**



475 136 mm 1 TL 475-SA

Stainless steel, anti-magnetic, anti-acid

Stainless Steel General Purpose Tweezers Style 649 with Serrated Handles and Bent, Beveled, Thick, Strong, Linearly Serrated Tips



**TL 649-SA**

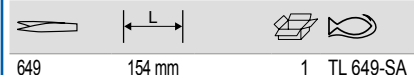

649 154 mm 1 TL 649-SA

Stainless steel, anti-magnetic, anti-acid

**SPARE PARTS & ACCESSORIES**

Set of 2 Carbon Fibre Tips and 3 Screws with Straight, Thick and Strong Tips TL 00CFR-SA



**TL 00ACF**



Set of 2 Carbon Fibre Tips and 3 Screws with Straight, Thick, Beveled and Strong Tips for TL 249CFR-SA



**TL 249ACF**

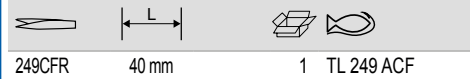

Set of 2 Carbon Fibre Tips and 3 Screws with Straight, Fine, Pointed and Strong Tips for TL 259CFR-SA



**TL 259ACF**



Set of 2 Carbon Fibre Tips and 3 Screws with Straight, Very Fine, Round and Flat Tips for TL 2ACFR-SA-TL 2AXCFR-SA



**TL 2AACF**



Set of 2 Carbon PEEK Tips and 3 Screws with Straight, Fine, Pointed and Strong Tips for TL 259CPR-SA



**TL 259ACP**

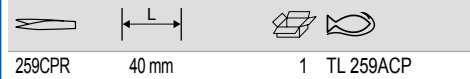

Set of 2 PVDF Tips and 3 Screws and Straight, Very Fine and Sharp Tips for TL 5SVR-SA-TL 5XSVR-SA



**TL 5ASV**



Set of 2 Carbon Fibre Tips and 3 Screws with Straight and Fine Tips for TL 242CFR-SA



**TL 242ACF**



Set of 2 PVDF Tips and 3 Screws with Straight, Fine, Pointed and Strong Tips for TL 259SVR-SA



**TL 259ASV**



Set of 2 Carbon Fibre Tips and 3 Screws with Straight, Very Fine and Sharp Tips for TL 5CFR-SA-TL 5XCFR-SA



**TL 5ACF**



Set of 2 Carbon Fibre Tips and 3 Screws with Curved and Very Fine Tips for TL 7CFR-SA



**TL 7ACF**



Set of 2 Carbon PEEK Tips and 3 Screws with Straight, Very Fine and Sharp Tips for TL 5CPR-SA-TL 5XCPR-SA



**TL 5ACP**



Set of 2 PVDF Tips and 3 Screws with Curved and Very Fine Tips for TL 7SVR-SA



**TL 7ASV**



Set of 2 Carbon PEEK tips and 3 Screws with Curved and Very Fine Tips for TL 7CPR-SA



**TL 7ACP**





|              |               |    |    |
|--------------|---------------|----|----|
| 1-100-04-1-0 | 7311518019006 | 10 | 22 |
| 1-100-04-1-2 | 7311518244125 | 5  | 22 |
| 1-100-04-2-0 | 7311518019013 | 10 | 22 |
| 1-100-04-2-2 | 7311518244132 | 5  | 22 |
| 1-100-04-3-0 | 7311518019020 | 10 | 22 |
| 1-100-06-1-0 | 7311518019037 | 10 | 22 |
| 1-100-06-1-2 | 7311518000233 | 5  | 22 |
| 1-100-06-2-0 | 7311518019044 | 10 | 22 |
| 1-100-06-2-2 | 7311518003593 | 5  | 22 |
| 1-100-06-3-0 | 7311518019051 | 10 | 22 |
| 1-100-06-3-2 | 7311518293581 | 5  | 22 |
| 1-100-08-1-0 | 7311518019068 | 10 | 22 |
| 1-100-08-1-2 | 7311518000264 | 5  | 22 |
| 1-100-08-2-0 | 7311518019075 | 10 | 22 |
| 1-100-08-2-2 | 7311518003609 | 5  | 22 |
| 1-100-08-3-0 | 7311518019082 | 10 | 22 |
| 1-100-08-3-2 | 7311518295585 | 5  | 22 |
| 1-100-10-1-0 | 7311518019099 | 10 | 22 |
| 1-100-10-1-2 | 7311518000295 | 5  | 22 |
| 1-100-10-2-0 | 7311518019105 | 10 | 22 |
| 1-100-10-2-2 | 7311518003616 | 5  | 22 |
| 1-100-10-3-0 | 7311518019112 | 10 | 22 |
| 1-100-10-3-2 | 7311518295592 | 5  | 22 |
| 1-100-12-1-0 | 7311518019129 | 5  | 22 |
| 1-100-12-1-2 | 7311518028053 | 5  | 22 |
| 1-100-12-2-0 | 7311518019136 | 5  | 22 |
| 1-100-12-2-2 | 7311518244118 | 5  | 22 |
| 1-100-12-3-0 | 7311518019143 | 5  | 22 |
| 1-100-12-3-2 | 7311518295608 | 5  | 22 |
| 1-100-14-1-0 | 7311518019150 | 5  | 22 |
| 1-100-14-2-0 | 7311518019167 | 5  | 22 |
| 1-102-06-2-0 | 7311518019198 | 10 | 22 |
| 1-102-06-3-0 | 7311518019204 | 10 | 22 |
| 1-102-08-1-0 | 7311518019211 | 10 | 22 |
| 1-102-08-2-0 | 7311518019228 | 10 | 22 |
| 1-102-08-3-0 | 7311518019235 | 10 | 22 |
| 1-104-10-2-0 | 7311518019242 | 10 | 22 |
| 1-104-10-3-0 | 7311518019259 | 10 | 22 |
| 1-104-12-2-0 | 7311518019266 | 5  | 22 |
| 1-104-12-3-0 | 7311518019273 | 5  | 22 |
| 1-104-14-3-0 | 7311518019297 | 5  | 22 |
| 1-106-08-1-0 | 7311518019303 | 10 | 22 |
| 1-106-08-1-2 | 7311518000301 | 5  | 22 |
| 1-106-10-1-0 | 7311518019310 | 10 | 22 |
| 1-106-10-1-2 | 7311518000325 | 5  | 22 |
| 1-106-12-1-0 | 7311518019327 | 5  | 22 |
| 1-106-12-1-2 | 7311518295615 | 5  | 22 |
| 1-110-04-1-0 | 7311518019334 | 10 | 22 |
| 1-110-04-2-0 | 7311518019341 | 10 | 22 |
| 1-110-04-3-0 | 7311518044046 | 10 | 22 |
| 1-110-06-1-0 | 7311518019358 | 10 | 22 |
| 1-110-06-1-2 | 7311518295622 | 5  | 23 |
| 1-110-06-2-0 | 7311518019365 | 10 | 22 |
| 1-110-06-2-2 | 7311518003623 | 5  | 23 |
| 1-110-06-3-0 | 7311518019372 | 10 | 22 |
| 1-110-06-3-2 | 7311518295639 | 5  | 23 |
| 1-110-08-1-0 | 7311518019389 | 10 | 22 |
| 1-110-08-1-2 | 7311518000332 | 5  | 23 |
| 1-110-08-2-0 | 7311518019396 | 10 | 22 |
| 1-110-08-2-2 | 7311518003630 | 5  | 23 |
| 1-110-08-3-0 | 7311518019402 | 10 | 22 |
| 1-110-08-3-2 | 7311518295646 | 5  | 23 |
| 1-110-10-1-0 | 7311518019419 | 10 | 22 |
| 1-110-10-1-2 | 7311518000349 | 5  | 23 |
| 1-110-10-2-0 | 7311518019426 | 10 | 22 |
| 1-110-10-2-2 | 7311518003647 | 5  | 23 |
| 1-110-10-3-0 | 7311518019433 | 10 | 22 |
| 1-110-10-3-2 | 7311518295653 | 5  | 23 |
| 1-110-12-1-0 | 7311518019440 | 5  | 22 |
| 1-110-12-1-2 | 7311518295660 | 5  | 23 |
| 1-110-12-2-0 | 7311518019457 | 5  | 22 |
| 1-110-12-2-2 | 7311518295677 | 5  | 23 |
| 1-110-12-3-0 | 7311518019464 | 5  | 22 |
| 1-110-12-3-2 | 7311518295684 | 5  | 23 |
| 1-110-14-1-0 | 7311518019488 | 5  | 22 |
| 1-111-04-1-0 | 7311518044053 | 10 | 23 |
| 1-111-04-2-0 | 7311518019518 | 10 | 23 |
| 1-111-04-3-0 | 7311518019525 | 10 | 23 |
| 1-111-06-1-0 | 7311518019549 | 10 | 23 |
| 1-111-06-2-0 | 7311518019556 | 10 | 23 |
| 1-111-06-2-2 | 7311518000363 | 5  | 23 |
| 1-111-06-3-0 | 7311518019563 | 10 | 23 |
| 1-111-08-1-0 | 7311518019570 | 10 | 23 |
| 1-111-08-2-0 | 7311518019587 | 10 | 23 |
| 1-115-11-3-1 | 7311518003791 | 10 | 23 |
| 1-143-04-1-0 | 7311518105983 | 10 | 23 |
| 1-143-06-1-0 | 7311518019631 | 10 | 23 |
| 1-143-06-1-2 | 7311518022341 | 5  | 23 |
| 1-143-08-1-0 | 7311518019662 | 10 | 23 |
| 1-143-08-1-2 | 7311518028077 | 5  | 23 |
| 1-143-10-1-0 | 7311518019693 | 10 | 23 |
| 1-143-10-1-2 | 7311518022358 | 5  | 23 |
| 1-143-12-1-0 | 7311518019723 | 5  | 23 |
| 1-143-12-1-2 | 7311518295691 | 5  | 23 |
| 1-160-04-1-0 | 7311518019785 | 10 | 25 |
| 1-160-04-1-2 | 7311518244057 | 5  | 25 |



|              |               |    |    |
|--------------|---------------|----|----|
| 1-160-04-2-0 | 7311518019792 | 10 | 25 |
| 1-160-04-2-2 | 7311518244095 | 5  | 25 |
| 1-160-04-3-0 | 7311518019808 | 10 | 25 |
| 1-160-06-1-0 | 7311518019815 | 10 | 25 |
| 1-160-06-1-2 | 7311518000370 | 5  | 25 |
| 1-160-06-2-0 | 7311518019822 | 10 | 25 |
| 1-160-06-2-2 | 7311518003685 | 5  | 25 |
| 1-160-06-3-0 | 7311518019839 | 10 | 25 |
| 1-160-06-3-2 | 7311518295707 | 5  | 25 |
| 1-160-08-1-0 | 7311518019846 | 10 | 25 |
| 1-160-08-1-2 | 7311518000394 | 5  | 25 |
| 1-160-08-2-0 | 7311518019853 | 10 | 25 |
| 1-160-08-2-2 | 7311518003692 | 5  | 25 |
| 1-160-08-3-0 | 7311518019860 | 10 | 25 |
| 1-160-08-3-2 | 7311518295714 | 5  | 25 |
| 1-160-10-1-0 | 7311518019877 | 10 | 25 |
| 1-160-10-1-2 | 7311518000400 | 5  | 25 |
| 1-160-10-2-0 | 7311518019884 | 10 | 25 |
| 1-160-10-2-2 | 7311518295721 | 5  | 25 |
| 1-160-10-3-0 | 7311518019891 | 10 | 25 |
| 1-160-10-3-2 | 7311518295738 | 5  | 25 |
| 1-160-12-1-0 | 7311518019907 | 5  | 25 |
| 1-160-12-1-2 | 7311518295745 | 5  | 25 |
| 1-160-12-2-0 | 7311518019914 | 5  | 25 |
| 1-160-12-2-2 | 7311518295752 | 5  | 25 |
| 1-160-12-3-0 | 7314150292059 | 5  | 25 |
| 1-160-12-3-2 | 7311518298005 | 5  | 25 |
| 1-170-04-1-0 | 7311518044060 | 10 | 24 |
| 1-170-04-2-0 | 7311518019945 | 10 | 24 |
| 1-170-04-2-2 | 7311518244088 | 5  | 24 |
| 1-170-04-3-0 | 7311518019952 | 10 | 24 |
| 1-170-06-1-0 | 7311518019969 | 10 | 24 |
| 1-170-06-1-2 | 7311518244071 | 5  | 24 |
| 1-170-06-2-0 | 7311518019976 | 10 | 24 |
| 1-170-06-2-2 | 7311518003715 | 5  | 24 |
| 1-170-06-3-0 | 7311518019983 | 10 | 24 |
| 1-170-06-3-2 | 7311518295769 | 5  | 24 |
| 1-170-08-1-0 | 7311518019990 | 10 | 24 |
| 1-170-08-1-2 | 7311518000417 | 5  | 24 |
| 1-170-08-2-0 | 7311518020002 | 10 | 24 |
| 1-170-08-2-2 | 7311518003722 | 5  | 24 |
| 1-170-08-3-0 | 7311518020019 | 10 | 24 |
| 1-170-08-3-2 | 7311518295783 | 5  | 24 |
| 1-170-10-1-0 | 7311518020026 | 10 | 24 |
| 1-170-10-1-2 | 7311518028107 | 5  | 24 |
| 1-170-10-2-0 | 7311518020033 | 10 | 24 |
| 1-170-10-2-2 | 7311518244064 | 5  | 24 |
| 1-170-10-3-0 | 7311518020040 | 10 | 24 |
| 1-170-10-3-2 | 7311518295806 | 5  | 24 |
| 1-170-12-1-0 | 7311518020057 | 5  | 24 |
| 1-170-12-2-0 | 7311518020064 | 5  | 24 |
| 1-210-04-1-0 | 7311518020071 | 10 | 24 |
| 1-210-04-1-2 | 7311518243944 | 5  | 24 |
| 1-210-04-2-0 | 7311518020088 | 10 | 24 |
| 1-210-04-2-2 | 7311518244040 | 5  | 24 |
| 1-210-04-3-0 | 7311518020095 | 10 | 24 |
| 1-210-06-1-0 | 7311518020101 | 10 | 24 |
| 1-210-06-1-2 | 7311518000424 | 5  | 24 |
| 1-210-06-2-0 | 7311518020118 | 10 | 24 |
| 1-210-06-2-2 | 7311518003654 | 5  | 24 |
| 1-210-06-3-0 | 7311518020125 | 10 | 24 |
| 1-210-06-3-2 | 7311518293574 | 5  | 24 |
| 1-210-08-1-0 | 7311518020132 | 10 | 24 |
| 1-210-08-1-2 | 7311518000455 | 5  | 24 |
| 1-210-08-2-0 | 7311518020149 | 10 | 24 |
| 1-210-08-2-2 | 7311518000479 | 5  | 24 |
| 1-210-08-3-0 | 7311518020156 | 10 | 24 |
| 1-210-08-3-2 | 7311518295837 | 5  | 24 |
| 1-210-10-1-0 | 7311518020163 | 10 | 24 |
| 1-210-10-1-2 | 7311518000493 | 5  | 24 |
| 1-210-10-2-0 | 7311518020170 | 10 | 24 |
| 1-210-10-2-2 | 7311518003661 | 5  | 24 |
| 1-210-10-3-0 | 7311518020187 | 10 | 24 |
| 1-210-10-3-2 | 7311518295844 | 5  | 24 |
| 1-210-12-1-0 | 7311518020194 | 5  | 24 |
| 1-210-12-1-2 | 7311518028121 | 5  | 24 |
| 1-210-12-2-0 | 7311518020200 | 5  | 24 |
| 1-210-12-2-2 | 7311518244149 | 5  | 24 |
| 1-210-12-3-0 | 7311518020217 | 5  | 24 |
| 1-210-12-3-2 | 7311518295851 | 5  | 24 |
| 1-210-14-1-0 | 7311518020224 | 5  | 24 |
| 1-230-04-1-0 | 7311518020248 | 10 | 24 |
| 1-230-04-1-2 | 7311518244163 | 5  | 24 |
| 1-230-04-2-0 | 7311518020255 | 10 | 24 |
| 1-230-04-2-2 | 7311518244156 | 5  | 24 |
| 1-230-04-3-0 | 7311518020262 | 10 | 24 |
| 1-230-06-1-0 | 7311518020279 | 10 | 24 |
| 1-230-06-1-2 | 7311518000509 | 5  | 24 |
| 1-230-06-2-0 | 7311518020286 | 10 | 24 |
| 1-230-06-2-2 | 7311518000523 | 5  | 24 |
| 1-230-06-3-0 | 7311518020293 | 10 | 24 |
| 1-230-06-3-2 | 7311518293567 | 5  | 24 |
| 1-230-08-1-0 | 7311518020309 | 10 | 24 |
| 1-230-08-1-2 | 7311518000547 | 5  | 24 |
| 1-230-08-2-0 | 7311518020316 | 10 | 24 |
| 1-230-08-2-2 | 7311518000554 | 5  | 24 |





|              |               |    |     |
|--------------|---------------|----|-----|
| 1-230-08-3-0 | 7311518020323 | 10 | 24  |
| 1-230-08-3-2 | 7311518295882 | 5  | 24  |
| 1-230-10-1-0 | 7311518020330 | 10 | 24  |
| 1-230-10-1-2 | 7311518000578 | 5  | 24  |
| 1-230-10-2-0 | 7311518020347 | 10 | 24  |
| 1-230-10-2-2 | 7311518003678 | 5  | 24  |
| 1-230-10-3-0 | 7311518020354 | 10 | 24  |
| 1-230-10-3-2 | 7311518295899 | 5  | 24  |
| 1-230-12-1-0 | 7311518020361 | 5  | 24  |
| 1-230-12-1-2 | 7311518295912 | 5  | 24  |
| 1-230-12-2-0 | 7311518020378 | 5  | 24  |
| 1-230-12-2-2 | 7311518295929 | 5  | 24  |
| 1-230-12-3-0 | 7311518020385 | 5  | 24  |
| 1-230-12-3-2 | 7311518295905 | 5  | 24  |
| 1-320-08-2-0 | 7311518191276 | 10 | 23  |
| 1-320-08-2-2 | 7311518270865 | 5  | 23  |
| 1-320-10-2-0 | 7311518020477 | 10 | 23  |
| 1-320-10-2-2 | 7311518270872 | 5  | 23  |
| 1-320-12-2-0 | 7311518020484 | 5  | 23  |
| 1-473-06-2-2 | 7311518201098 | 5  | 25  |
| 1-473-08-2-2 | 7311518201104 | 5  | 25  |
| 1-473-10-2-2 | 7311518201111 | 5  | 25  |
| 1-476-04-3-2 | 7311518010928 | 1  | 25  |
| 1-477-08-2-2 | 7311518037994 | 5  | 25  |
| 1-477-10-2-2 | 7311518201074 | 5  | 26  |
| 1-478-08-1-2 | 7311518141127 | 5  | 26  |
| 1-478-10-1-2 | 7311518241995 | 5  | 26  |
| 1-479-08-1-2 | 7311518176747 | 5  | 26  |
| 1-479-08-2-2 | 7311518180607 | 5  | 26  |
| 10-21-51     | 7311518229344 | 5  | 633 |
| 10-24-23     | 7311518229368 | 5  | 633 |
| 10-24-51     | 7311518229351 | 5  | 633 |
| 10-30-23     | 7311518229382 | 5  | 633 |
| 10-30-51     | 7311518229375 | 5  | 633 |
| 1016         | 7314150218189 | 10 | 218 |
| 1019         | 8412814010199 | 10 | 218 |
| 1031-10      | 7314150025442 | 5  | 571 |
| 1031-12      | 7314150025459 | 5  | 571 |
| 1031-14      | 7314150025466 | 5  | 571 |
| 1031-16      | 7314150025473 | 5  | 571 |
| 1031-18      | 7314150025480 | 5  | 571 |
| 1031-20      | 7314150025497 | 5  | 571 |
| 1031-22      | 7314150025503 | 5  | 571 |
| 1031-25      | 7314150025510 | 5  | 571 |
| 1031-28      | 7314150025527 | 5  | 571 |
| 1031-30      | 7314150025534 | 5  | 571 |
| 1031-32      | 7314150025541 | 5  | 571 |
| 1031-4       | 7314150025411 | 5  | 571 |
| 1031-40      | 7314150025558 | 5  | 571 |
| 1031-6       | 7314150025428 | 5  | 571 |
| 1031-8       | 7314150025435 | 5  | 571 |
| 1067         | 8412814010670 | 10 | 218 |
| 1084         | 7311518277291 | 5  | 270 |
| 10RM-10      | 7314153014351 | 1  | 45  |
| 10RM-13      | 7314153014368 | 1  | 45  |
| 10RM-14      | 7314150221677 | 1  | 45  |
| 10RM-17      | 7314153014375 | 1  | 45  |
| 10RM-19      | 7314153014382 | 1  | 45  |
| 10RM-8       | 7314153014344 | 1  | 45  |
| 10RM/SH6     | 7314150222971 | 1  | 46  |
| 10RZ-1/2     | 7314150358786 | 1  | 45  |
| 10RZ-11/16   | 7314150358816 | 1  | 45  |
| 10RZ-3/4     | 7314150358823 | 1  | 45  |
| 10RZ-3/8     | 7314150358762 | 1  | 45  |
| 10RZ-5/16    | 7314150358748 | 1  | 45  |
| 10RZ-5/8     | 7314150358809 | 1  | 45  |
| 10RZ-7/16    | 7314150358779 | 1  | 45  |
| 10RZ-9/16    | 7314150358793 | 1  | 45  |
| 111A         | 7314150476183 | 5  | 653 |
| 111M-10      | 7314151828653 | 10 | 40  |
| 111M-100     | 7314150401499 | 1  | 40  |
| 111M-11      | 7314151828660 | 10 | 40  |
| 111M-12      | 7314151828677 | 10 | 40  |
| 111M-13      | 7314151828684 | 10 | 40  |
| 111M-14      | 7314151828691 | 10 | 40  |
| 111M-15      | 7314151828707 | 10 | 40  |
| 111M-16      | 7314151828714 | 10 | 40  |
| 111M-17      | 7314151828721 | 10 | 40  |
| 111M-18      | 7314151828738 | 10 | 40  |
| 111M-19      | 7314151828745 | 10 | 40  |
| 111M-20      | 7314151828752 | 10 | 40  |
| 111M-21      | 7314151828769 | 10 | 40  |
| 111M-22      | 7314151828776 | 5  | 40  |
| 111M-23      | 7314151828783 | 5  | 40  |
| 111M-24      | 7314151828790 | 5  | 40  |
| 111M-25      | 7314151828806 | 5  | 40  |
| 111M-26      | 7314151828813 | 5  | 40  |
| 111M-27      | 7314151828820 | 5  | 40  |
| 111M-28      | 7314151828837 | 5  | 40  |
| 111M-29      | 7314151828844 | 5  | 40  |
| 111M-30      | 7314151828851 | 5  | 40  |
| 111M-32      | 7314151828868 | 5  | 40  |
| 111M-33      | 7314150222223 | 5  | 40  |
| 111M-34      | 7314151828875 | 5  | 40  |
| 111M-36      | 7314150135516 | 1  | 40  |
| 111M-38      | 7314150222230 | 1  | 40  |



|              |               |    |     |
|--------------|---------------|----|-----|
| 111M-41      | 7314150135523 | 1  | 40  |
| 111M-46      | 7314150135530 | 1  | 40  |
| 111M-5.5     | 7314151828608 | 10 | 40  |
| 111M-50      | 7314150135547 | 1  | 40  |
| 111M-55      | 7314150135554 | 1  | 40  |
| 111M-6       | 7314151828615 | 10 | 40  |
| 111M-60      | 7314150135561 | 1  | 40  |
| 111M-65      | 7314150135578 | 1  | 40  |
| 111M-7       | 7314151828622 | 10 | 40  |
| 111M-70      | 7314150135585 | 1  | 40  |
| 111M-75      | 7314150135592 | 1  | 40  |
| 111M-8       | 7314151828639 | 10 | 40  |
| 111M-80      | 7314150135608 | 1  | 40  |
| 111M-85      | 7314150352999 | 1  | 40  |
| 111M-9       | 7314151828646 | 10 | 40  |
| 111M-90      | 7314150401475 | 1  | 40  |
| 111M-95      | 7314150401482 | 1  | 40  |
| 111M/11T     | 7314151828899 | 1  | 42  |
| 111M/14T     | 7314151828905 | 1  | 42  |
| 111M/17T     | 7314151828912 | 1  | 42  |
| 111M/17TL    | 7314150197859 | 1  | 42  |
| 111M/24T     | 7314150197866 | 1  | 42  |
| 111M/26T     | 7314151828929 | 1  | 42  |
| 111M/S10     | 7314150212965 | 1  | 42  |
| 111M/SH12    | 7314153013347 | 1  | 41  |
| 111M/SH5     | 7314150325252 | 1  | 41  |
| 111M/SH8     | 7314150197873 | 1  | 41  |
| 111Z-1       | 7314151829063 | 3  | 41  |
| 111Z-1.1/16  | 7314151829070 | 5  | 41  |
| 111Z-1.1/2   | 7314150135752 | 1  | 41  |
| 111Z-1.1/4   | 7314151829094 | 5  | 41  |
| 111Z-1.1/8   | 7314151829087 | 5  | 41  |
| 111Z-1.11/16 | 7314150135615 | 1  | 41  |
| 111Z-1.13/16 | 7314150135639 | 1  | 41  |
| 111Z-1.3/4   | 7314150135622 | 1  | 41  |
| 111Z-1.3/8   | 7314150135738 | 1  | 41  |
| 111Z-1.5/16  | 7314151829100 | 5  | 41  |
| 111Z-1.5/8   | 7314150135769 | 1  | 41  |
| 111Z-1.7/16  | 7314150135745 | 1  | 41  |
| 111Z-1.7/8   | 7314150135646 | 1  | 41  |
| 111Z-1/2     | 7314151828981 | 5  | 41  |
| 111Z-1/4     | 7314151828943 | 5  | 41  |
| 111Z-11/16   | 7314151829018 | 5  | 41  |
| 111Z-13/16   | 7314151829032 | 5  | 41  |
| 111Z-15/16   | 7314151829056 | 3  | 41  |
| 111Z-2       | 7314150135653 | 1  | 41  |
| 111Z-2.1/2   | 7314150135721 | 1  | 41  |
| 111Z-2.1/4   | 7314150135691 | 1  | 41  |
| 111Z-2.1/8   | 7314150135677 | 1  | 41  |
| 111Z-2.3/4   | 7314150135783 | 1  | 41  |
| 111Z-2.3/8   | 7314150135707 | 1  | 41  |
| 111Z-2.5/8   | 7314150135776 | 1  | 41  |
| 111Z-2.7/8   | 7314150135790 | 1  | 41  |
| 111Z-3       | 7314150135806 | 1  | 41  |
| 111Z-3/4     | 7314151829025 | 5  | 41  |
| 111Z-3/8     | 7314151828967 | 5  | 41  |
| 111Z-5/16    | 7314151828950 | 5  | 41  |
| 111Z-5/8     | 7314151829001 | 5  | 41  |
| 111Z-7/16    | 7314151828974 | 5  | 41  |
| 111Z-7/8     | 7314151829049 | 5  | 41  |
| 111Z-9/16    | 7314151828998 | 5  | 41  |
| 111Z/11T     | 7314151829124 | 1  | 43  |
| 111Z/8T      | 7314151829117 | 1  | 42  |
| 1150-1/2H/P  | 7314150129263 | 1  | 545 |
| 1150D        | 7311518276614 | 1  | 545 |
| 1154         | 7314150249831 | 1  | 326 |
| 1154-DG      | 7314150249800 | 1  | 326 |
| 1154-MB      | 7314150249817 | 1  | 326 |
| 1157         | 7311518277031 | 60 | 606 |
| 1162N-1/2    | 7314151847241 | 1  | 538 |
| 1177-SCRIBE  | 7314150120550 | 5  | 543 |
| 1178-SCRIBE  | 7314150120567 | 5  | 543 |
| 1179-FLX     | 7311518276997 | 25 | 543 |
| 1179-SCRIBE  | 7314150120574 | 5  | 543 |
| 1179-TIPS    | 7314150120581 | 1  | 543 |
| 11M-10       | 7314151829155 | 5  | 43  |
| 11M-11       | 7314151829162 | 5  | 43  |
| 11M-12       | 7314151829179 | 5  | 43  |
| 11M-13       | 7314151829186 | 5  | 43  |
| 11M-14       | 7314151829193 | 5  | 43  |
| 11M-15       | 7314151829209 | 5  | 43  |
| 11M-16       | 7314151829216 | 5  | 43  |
| 11M-17       | 7314151829223 | 5  | 43  |
| 11M-18       | 7314151829230 | 5  | 43  |
| 11M-19       | 7314151829247 | 5  | 43  |
| 11M-21       | 7314151829254 | 5  | 43  |
| 11M-22       | 7314151829261 | 5  | 43  |
| 11M-24       | 7314151829278 | 5  | 43  |
| 11M-27       | 7314151829285 | 1  | 43  |
| 11M-30       | 7314151829292 | 1  | 43  |
| 11M-32       | 7314151829308 | 1  | 43  |
| 11M-36       | 7314151829315 | 1  | 43  |
| 11M-38       | 7314151829322 | 1  | 43  |
| 11M-8        | 7314151829131 | 5  | 43  |
| 11M-9        | 7314151829148 | 5  | 43  |
| 11Z-1        | 7314150355303 | 5  | 43  |





|                   |                |    |     |
|-------------------|----------------|----|-----|
| 11Z-1/2           | 7314150355235  | 5  | 43  |
| 11Z-11/16         | 7314150355266  | 5  | 43  |
| 11Z-13/16         | 7314150355280  | 5  | 43  |
| 11Z-3/4           | 7314150355273  | 5  | 43  |
| 11Z-3/8           | 7314150355211  | 5  | 43  |
| 11Z-5/8           | 7314150355259  | 5  | 43  |
| 11Z-7/16          | 7314150355228  | 5  | 43  |
| 11Z-9/16          | 7314150355242  | 5  | 43  |
| 121A              | 7314150476206  | 5  | 653 |
| 1300Z-1-1.1/8     | 7314153000989  | 1  | 52  |
| 1300Z-1/2-9/16    | 7314151039998  | 1  | 52  |
| 1300Z-1/4-5/16    | 7314153000965  | 1  | 52  |
| 1300Z-15/16-1     | 7314153005656  | 1  | 52  |
| 1300Z-19/32-11/16 | 7314151040000  | 1  | 52  |
| 1300Z-25/32-13/16 | 7314153000972  | 1  | 52  |
| 1300Z-3/8-7/16    | 7314151039981  | 1  | 52  |
| 1300Z-5/8-3/4     | 7314151040017  | 1  | 52  |
| 1300Z-7/8-15/16   | 7314153005649  | 1  | 52  |
| 1320RM-10-11      | 7314153014511  | 1  | 47  |
| 1320RM-12-13      | 7314153014528  | 1  | 47  |
| 1320RM-14-15      | 7314153014535  | 1  | 47  |
| 1320RM-16-17      | 7314153014542  | 1  | 47  |
| 1320RM-17-19      | 73141530359196 | 1  | 47  |
| 1320RM-18-19      | 7314153014559  | 1  | 47  |
| 1320RM-22-24      | 7314150221646  | 1  | 47  |
| 1320RM-6-7        | 7314153014498  | 1  | 47  |
| 1320RM-8-9        | 7314153014504  | 1  | 47  |
| 1320RM/SH8        | 7314150222988  | 1  | 47  |
| 1320RZ-1/2-9/16   | 7314153014580  | 1  | 47  |
| 1320RZ-1/4-5/16   | 7314153014566  | 1  | 47  |
| 1320RZ-3/4-13/16  | 7314150359264  | 1  | 47  |
| 1320RZ-3/4-7/8    | 7314150359271  | 1  | 47  |
| 1320RZ-3/8-7/16   | 7314153014573  | 1  | 47  |
| 1320RZ-5/16-11/32 | 7314153015235  | 60 | 47  |
| 1320RZ-5/8-11/16  | 7314150359257  | 1  | 47  |
| 1320RZ-7/8-15/16  | 7314150359288  | 1  | 47  |
| 1320SRM-14-19     | 7314150190355  | 1  | 47  |
| 1320SRM/S29       | 7314150188673  | 1  | 47  |
| 1321RZ-1/2-9/16   | 7314150359349  | 1  | 47  |
| 1321RZ-3/4-7/8    | 7314150359363  | 1  | 47  |
| 1321RZ-3/8-7/16   | 7314150359332  | 1  | 47  |
| 1321RZ-5/8-11/16  | 7314150359356  | 1  | 47  |
| 133SGM-100        | 7314151828523  | 1  | 55  |
| 133SGM-105        | 7314151828530  | 1  | 55  |
| 133SGM-110        | 7314151828547  | 1  | 55  |
| 133SGM-115        | 7314151828554  | 1  | 55  |
| 133SGM-120        | 7314151828561  | 1  | 55  |
| 133SGM-27         | 7314151828363  | 1  | 55  |
| 133SGM-30         | 7314151828370  | 1  | 55  |
| 133SGM-32         | 7314151828387  | 1  | 55  |
| 133SGM-36         | 7314151828394  | 1  | 55  |
| 133SGM-41         | 7314151828400  | 1  | 55  |
| 133SGM-46         | 7314151828417  | 1  | 55  |
| 133SGM-50         | 7314151828424  | 1  | 55  |
| 133SGM-55         | 7314151828431  | 1  | 55  |
| 133SGM-60         | 7314151828448  | 1  | 55  |
| 133SGM-65         | 7314151828455  | 1  | 55  |
| 133SGM-70         | 7314151828462  | 1  | 55  |
| 133SGM-75         | 7314151828479  | 1  | 55  |
| 133SGM-80         | 7314151828486  | 1  | 55  |
| 133SGM-85         | 7314151828493  | 1  | 55  |
| 133SGM-90         | 7314151828509  | 1  | 55  |
| 133SGM-95         | 7314151828516  | 1  | 55  |
| 14-24-3810        | 7311518002879  | 5  | 634 |
| 140               | 7314150008797  | 1  | 266 |
| 141               | 7314150008827  | 1  | 266 |
| 1410              | 7314150106332  | 1  | 266 |
| 1410D             | 7314150452842  | 1  | 266 |
| 1418-4            | 7314150510863  | 1  | 370 |
| 1418-5            | 7314150510870  | 1  | 370 |
| 1418-6            | 7314150510887  | 1  | 370 |
| 1418-7.5          | 7314150510894  | 1  | 370 |
| 1418-8.5          | 7314150510900  | 1  | 370 |
| 1418S             | 7314151040604  | 1  | 369 |
| 1419-M12          | 7314150257423  | 1  | 369 |
| 1419-M16          | 7314150358045  | 1  | 369 |
| 1419-M5           | 7314150257409  | 1  | 369 |
| 1419-M8           | 7314150257416  | 1  | 369 |
| 1419-MD           | 7311518277352  | 1  | 342 |
| 1419/4            | 7314150125036  | 1  | 369 |
| 142               | 7314150008841  | 1  | 266 |
| 1420              | 7314150103744  | 1  | 266 |
| 1420-1.4          | 7314151696337  | 1  | 369 |
| 1420D             | 7314150452859  | 1  | 266 |
| 1421-2.1          | 7314151696412  | 1  | 369 |
| 1422-3.1          | 7314151696689  | 1  | 369 |
| 1423-4.8          | 7314151696764  | 1  | 369 |
| 1424-6.2          | 7314151696849  | 1  | 369 |
| 143               | 7314150008872  | 1  | 266 |
| 1430FT120         | 7314150342006  | 1  | 384 |
| 1435/5            | 7314151040734  | 1  | 369 |
| 1435/8            | 7314151040741  | 1  | 369 |
| 144               | 7314150008902  | 1  | 266 |
| 1446              | 7314150128631  | 15 | 584 |
| 1446-CS           | 7314150508266  | 15 | 584 |
| 1446-FLOAT        | 7314150438464  | 15 | 584 |



|                  |               |    |     |
|------------------|---------------|----|-----|
| 1446-FLOAT-B     | 7314150524310 | 12 | 585 |
| 1446-OV          | 7314150313679 | 15 | 585 |
| 1450D-ISO        | 7314151040970 | 1  | 372 |
| 1450D-VVV        | 7314151040987 | 1  | 372 |
| 1450D/2          | 7314151040963 | 1  | 372 |
| 1460M/1          | 7314151041090 | 1  | 371 |
| 1460M/2          | 7314151041106 | 1  | 371 |
| 1460Z/2          | 7314151041120 | 1  | 372 |
| 1467-250         | 7314150124268 | 1  | 263 |
| 1467-320-850     | 7314150178636 | 1  | 263 |
| 1467-520         | 7314150124275 | 1  | 263 |
| 1467-LJ          | 7314150209033 | 1  | 264 |
| 1467-SJ          | 7314150208982 | 1  | 264 |
| 1468-10M10       | 7314150243457 | 1  | 349 |
| 1468-10M4        | 7314150243419 | 1  | 349 |
| 1468-10M5        | 7314150243426 | 1  | 349 |
| 1468-10M6        | 7314150243433 | 1  | 349 |
| 1468-10M8        | 7314150243440 | 1  | 349 |
| 1468-6M3         | 7314150243372 | 1  | 349 |
| 1468-6M4         | 7314150243389 | 1  | 349 |
| 1468-6M5         | 7314150243396 | 1  | 349 |
| 1468-6M6         | 7314150243402 | 1  | 349 |
| 1468-M10         | 7314150243228 | 6  | 348 |
| 1468-M6          | 7314150243211 | 1  | 348 |
| 147              | 7314150008933 | 1  | 266 |
| 147-1            | 7314150367047 | 1  | 117 |
| 147-1.1/4        | 7314150367061 | 1  | 117 |
| 147-1.1/8        | 7314150367054 | 1  | 117 |
| 147-1/2          | 7314150366965 | 1  | 117 |
| 147-11/16        | 7314150366996 | 1  | 117 |
| 147-13           | 7314150366644 | 1  | 117 |
| 147-13/16        | 7314150367016 | 1  | 117 |
| 147-14           | 7314150366651 | 1  | 117 |
| 147-15           | 7314150366668 | 1  | 117 |
| 147-15/16        | 7314150367030 | 1  | 117 |
| 147-16           | 7314150366675 | 1  | 117 |
| 147-17           | 7314150366682 | 1  | 117 |
| 147-18           | 7314150366699 | 1  | 117 |
| 147-19           | 7314150366705 | 1  | 117 |
| 147-21           | 7314150366712 | 1  | 117 |
| 147-22           | 7314150366729 | 1  | 117 |
| 147-24           | 7314150366736 | 1  | 117 |
| 147-25           | 7314150366743 | 1  | 117 |
| 147-27           | 7314150366750 | 1  | 117 |
| 147-3/4          | 7314150367009 | 1  | 117 |
| 147-30           | 7314150366767 | 1  | 117 |
| 147-32           | 7314150366774 | 1  | 117 |
| 147-33           | 7314150366781 | 1  | 117 |
| 147-34           | 7314150366798 | 1  | 117 |
| 147-35           | 7314150366804 | 1  | 117 |
| 147-36           | 7314150366811 | 1  | 117 |
| 147-37           | 7314150366828 | 1  | 117 |
| 147-38           | 7314150366835 | 1  | 117 |
| 147-39           | 7314150366842 | 1  | 117 |
| 147-41           | 7314150366859 | 1  | 117 |
| 147-45           | 7314150366866 | 1  | 117 |
| 147-46           | 7314150366873 | 1  | 117 |
| 147-5/8          | 7314150366989 | 1  | 117 |
| 147-50           | 7314150366880 | 1  | 117 |
| 147-55           | 7314150366897 | 1  | 117 |
| 147-60           | 7314150366903 | 1  | 117 |
| 147-65           | 7314150537860 | 1  | 117 |
| 147-68           | 7314150366910 | 1  | 117 |
| 147-7/16         | 7314150366958 | 1  | 117 |
| 147-7/8          | 7314150367023 | 1  | 117 |
| 147-70           | 7314150366927 | 1  | 117 |
| 147-75           | 7314150366934 | 1  | 117 |
| 147-9/16         | 7314150366972 | 1  | 117 |
| 147-90           | 7314150366941 | 1  | 117 |
| 1470K-AC1        | 7314150226498 | 1  | 382 |
| 1470K-AC2        | 7314150226504 | 1  | 382 |
| 1470K-AC3        | 7314150226511 | 1  | 382 |
| 1470K-AC4        | 7314150226528 | 1  | 382 |
| 1470K-AC7        | 7314150271320 | 1  | 383 |
| 1470K-AC8        | 7314150328581 | 1  | 383 |
| 1470K-AC8GR      | 7314150328598 | 1  | 383 |
| 1470K-ACSIDE     | 7314150226535 | 1  | 383 |
| 1470K-ACTD       | 7314150297269 | 1  | 382 |
| 1470K-ACTSS      | 7314150297283 | 1  | 382 |
| 1470K-ACTW       | 7314150297276 | 1  | 382 |
| 1470K7LH         | 7314150360444 | 1  | 381 |
| 1470K7LHBLUE     | 7314150407491 | 1  | 381 |
| 1470K7LHGREY     | 7314150407767 | 1  | 381 |
| 1470K7LHRED      | 7314150407507 | 1  | 381 |
| 1470KC2          | 7314150226696 | 1  | 383 |
| 1470KC3A         | 7314150506354 | 1  | 383 |
| 1470KC5          | 7314150226665 | 1  | 383 |
| 1470KC5PC        | 7314150226672 | 1  | 383 |
| 1470KCTRAY       | 7314150226702 | 1  | 383 |
| 1470KXL-ACTD     | 7314150297290 | 1  | 382 |
| 1470KXL-ACTSS    | 7314150297313 | 1  | 382 |
| 1470KXL-ACTW     | 7314150297306 | 1  | 382 |
| 1470KXLC-TRAY    | 7314150285549 | 1  | 383 |
| 1471KXXL12BKTTSS | 7314150365432 | 1  | 380 |
| 1472K-ACTD       | 7314150399345 | 1  | 380 |
| 1472K-ACTSS      | 7314150399338 | 1  | 380 |



# 1472K-ACTW



|                  |               |   |     |
|------------------|---------------|---|-----|
| 1472K-ACTW       | 7314150393152 | 1 | 380 |
| 1472K5           | 7314150349463 | 1 | 377 |
| 1472K5BLACK      | 7314150349500 | 1 | 377 |
| 1472K5BLUE       | 7314150349616 | 1 | 377 |
| 1472K5GREY       | 7314150403813 | 1 | 377 |
| 1472K5RED        | 7314150349562 | 1 | 377 |
| 1472K5WHITE      | 7314150403707 | 1 | 377 |
| 1472K6           | 7314150349470 | 1 | 377 |
| 1472K6BLACK      | 7314150349531 | 1 | 377 |
| 1472K6BLUE       | 7314150349623 | 1 | 377 |
| 1472K6GREY       | 7314150403820 | 1 | 377 |
| 1472K6RED        | 7314150349579 | 1 | 377 |
| 1472K6WHITE      | 7314150399888 | 1 | 377 |
| 1472K7           | 7314150349487 | 1 | 377 |
| 1472K7BLACK      | 7314150349548 | 1 | 377 |
| 1472K7BLUE       | 7314150349630 | 1 | 377 |
| 1472K7GREY       | 7314150403837 | 1 | 377 |
| 1472K7RED        | 7314150349586 | 1 | 377 |
| 1472K7WHITE      | 7314150403714 | 1 | 377 |
| 1472K8           | 7314150349494 | 1 | 376 |
| 1472K8BLACK      | 7314150349555 | 1 | 376 |
| 1472K8BLUE       | 7314150349647 | 1 | 376 |
| 1472K8GREY       | 7314150404018 | 1 | 376 |
| 1472K8RED        | 7314150349593 | 1 | 376 |
| 1472K8WHITE      | 7314150403721 | 1 | 376 |
| 1475K-ACSIDE     | 7314150419968 | 1 | 383 |
| 1475K6           | 7314150349654 | 1 | 381 |
| 1475K6BLACK      | 7314150349685 | 1 | 381 |
| 1475K6BLUE       | 7314150349760 | 1 | 381 |
| 1475K6RED        | 7314150349715 | 1 | 381 |
| 1475K7           | 7314150349661 | 1 | 381 |
| 1475K7BLACK      | 7314150349692 | 1 | 381 |
| 1475K7BLUE       | 7314150349814 | 1 | 381 |
| 1475K7RED        | 7314150349746 | 1 | 381 |
| 1475K8           | 7314150349678 | 1 | 381 |
| 1475K8BLACK      | 7314150349708 | 1 | 381 |
| 1475K8BLUE       | 7314150349821 | 1 | 381 |
| 1475K8RED        | 7314150349753 | 1 | 381 |
| 1475KXL-AC20BK   | 7314150353903 | 1 | 382 |
| 1475KXL12        | 7314150350223 | 1 | 380 |
| 1475KXL12BLACK   | 7314150350230 | 1 | 380 |
| 1475KXL12RED     | 7314150402731 | 1 | 380 |
| 1475KXL6         | 7314150349968 | 1 | 381 |
| 1475KXL6BLACK    | 7314150349999 | 1 | 381 |
| 1475KXL6BLUE     | 7314150350162 | 1 | 381 |
| 1475KXL6C        | 7314150350193 | 1 | 381 |
| 1475KXL6CCKB-FF5 | 7314150437467 | 1 | 376 |
| 1475KXL6CCKB-FF6 | 7314150437474 | 1 | 375 |
| 1475KXL6CBLACK   | 7314150350209 | 1 | 381 |
| 1475KXL6RED      | 7314150350124 | 1 | 381 |
| 1475KXL7         | 7314150349975 | 1 | 380 |
| 1475KXL7BLACK    | 7314150350070 | 1 | 380 |
| 1475KXL7BLUE     | 7314150350179 | 1 | 380 |
| 1475KXL7RED      | 7314150350148 | 1 | 380 |
| 1475KXL8         | 7314150349982 | 1 | 380 |
| 1475KXL8BLACK    | 7314150350094 | 1 | 380 |
| 1475KXL8BLUE     | 7314150350186 | 1 | 380 |
| 1475KXL8RED      | 7314150350155 | 1 | 380 |
| 1475KXXL-ACTSS   | 7314150459896 | 1 | 381 |
| 1475KXXL-ACTW    | 7314150465330 | 1 | 382 |
| 1475KXXL8CWTSS   | 7314150400157 | 1 | 380 |
| 1476KXXL7BK      | 7314150439935 | 1 | 380 |
| 1477K-AC10       | 7314150353163 | 1 | 379 |
| 1477K-AC12       | 7314150369195 | 1 | 377 |
| 1477K-AC13       | 7314150369218 | 1 | 377 |
| 1477K-AC14       | 7314150369225 | 1 | 378 |
| 1477K-AC15       | 7314150369249 | 1 | 378 |
| 1477K-AC16       | 7314150369256 | 1 | 378 |
| 1477K-AC17       | 7314150369270 | 1 | 378 |
| 1477K-AC18       | 7314150369287 | 1 | 378 |
| 1477K-AC19       | 7314150369676 | 1 | 378 |
| 1477K-AC20       | 7314150369683 | 1 | 378 |
| 1477K-AC21       | 7314150370412 | 1 | 378 |
| 1477K-AC22       | 7314150369706 | 1 | 378 |
| 1477K-AC24       | 7314150370429 | 1 | 379 |
| 1477K-AC25       | 7314150370436 | 1 | 379 |
| 1477K-AC26       | 7314150414864 | 1 | 379 |
| 1477K-AC30       | 7314150469949 | 1 | 379 |
| 1477K-ACTD       | 7314150370474 | 1 | 379 |
| 1477K-ACTP       | 7314150383764 | 1 | 379 |
| 1477K-ACTSS      | 7314150370450 | 1 | 379 |
| 1477K-ACTW       | 7314150370467 | 1 | 379 |
| 1477K6           | 7314150350391 | 1 | 376 |
| 1477K6BLACK      | 7314150351091 | 1 | 376 |
| 1477K6GREY       | 7314150351138 | 1 | 376 |
| 1477K6RED        | 7314150403653 | 1 | 376 |
| 1477K6WHITE      | 7314150358137 | 1 | 376 |
| 1477K7           | 7314150350407 | 1 | 376 |
| 1477K7BLACK      | 7314150351107 | 1 | 376 |
| 1477K7GREY       | 7314150351145 | 1 | 376 |
| 1477K7RED        | 7314150403660 | 1 | 376 |
| 1477K7WHITE      | 7314150358144 | 1 | 376 |
| 1477K8           | 7314150350414 | 1 | 376 |
| 1477K8BLACK      | 7314150351114 | 1 | 376 |
| 1477K8GREY       | 7314150351183 | 1 | 376 |
| 1477K8RED        | 7314150403677 | 1 | 376 |



|                 |               |   |     |
|-----------------|---------------|---|-----|
| 1477K8WHITE     | 7314150358151 | 1 | 376 |
| 1477K9          | 7314150350940 | 1 | 376 |
| 1477K9BLACK     | 7314150351121 | 1 | 376 |
| 1477K9GREY      | 7314150351190 | 1 | 376 |
| 1477K9RED       | 7314150403684 | 1 | 376 |
| 1477K9WHITE     | 7314150403691 | 1 | 376 |
| 148-1           | 7314150367801 | 1 | 118 |
| 148-1/2         | 7314150367726 | 1 | 118 |
| 148-11/16       | 7314150367757 | 1 | 118 |
| 148-13          | 7314150367559 | 1 | 118 |
| 148-13/16       | 7314150367771 | 1 | 118 |
| 148-14          | 7314150367566 | 1 | 118 |
| 148-15          | 7314150367573 | 1 | 118 |
| 148-15/16       | 7314150367795 | 1 | 118 |
| 148-16          | 7314150367580 | 1 | 118 |
| 148-17          | 7314150367597 | 1 | 118 |
| 148-18          | 7314150367603 | 1 | 118 |
| 148-19          | 7314150367610 | 1 | 118 |
| 148-21          | 7314150367627 | 1 | 118 |
| 148-22          | 7314150367634 | 1 | 118 |
| 148-24          | 7314150367641 | 1 | 118 |
| 148-27          | 7314150367658 | 1 | 118 |
| 148-28          | 7314150367665 | 1 | 118 |
| 148-3/4         | 7314150367764 | 1 | 118 |
| 148-30          | 7314150367672 | 1 | 118 |
| 148-32          | 7314150367689 | 1 | 118 |
| 148-34          | 7314150367696 | 1 | 118 |
| 148-36          | 7314150367702 | 1 | 118 |
| 148-41          | 7314150367719 | 1 | 118 |
| 148-5/8         | 7314150367740 | 1 | 118 |
| 148-7/8         | 7314150367788 | 1 | 118 |
| 148-9/16        | 7314150367733 | 1 | 118 |
| 1482K4          | 7314150415779 | 1 | 377 |
| 1482K4BKW       | 7314150426126 | 1 | 377 |
| 1482K4BLACK     | 7314150415786 | 1 | 377 |
| 1482K4BLUE      | 7314150415793 | 1 | 377 |
| 1482K4GREY      | 7314150415809 | 1 | 377 |
| 1482K4RED       | 7314150415816 | 1 | 377 |
| 1482K4W         | 7314150425174 | 1 | 377 |
| 1482K4WHITE     | 7314150415823 | 1 | 377 |
| 1482K5W         | 7314150431274 | 1 | 377 |
| 1483CART        | 7314150273256 | 1 | 458 |
| 1483K2RB        | 7314150230013 | 1 | 458 |
| 1483K3RB        | 7314150230037 | 1 | 458 |
| 1483KHD3RB      | 7314150230099 | 1 | 458 |
| 1483KHD3RB-FF1  | 7314150233564 | 1 | 456 |
| 1483KHD3RB-FF2  | 7314150233571 | 1 | 456 |
| 1483KHD3RB-FF3  | 7314150233588 | 1 | 457 |
| 1483KHD3RB-FF4  | 7314150233595 | 1 | 457 |
| 1483KHD3RB-FF5  | 7314150233601 | 1 | 457 |
| 1483KHD3RB-FF7  | 7314150336050 | 1 | 457 |
| 1483KHD4RB      | 7314150230105 | 1 | 458 |
| 1484THD3RB      | 7314150265435 | 1 | 458 |
| 1485K4          | 7314150349838 | 1 | 381 |
| 1485K4BLACK     | 7314150349920 | 1 | 381 |
| 1485K4BLUE      | 7314150349944 | 1 | 381 |
| 1485K4RED       | 7314150349937 | 1 | 381 |
| 1485KXL4        | 7314150350247 | 1 | 381 |
| 1485KXL4BLACK   | 7314150350346 | 1 | 381 |
| 1485KXL4BLUE    | 7314150350360 | 1 | 381 |
| 1485KXL4RED     | 7314150350353 | 1 | 381 |
| 1487K4          | 7314150351206 | 1 | 376 |
| 1487K4BKW       | 7314150426133 | 1 | 376 |
| 1487K4BLACK     | 7314150351213 | 1 | 376 |
| 1487K4GREY      | 7314150351237 | 1 | 376 |
| 1487K4W         | 7314150425181 | 1 | 376 |
| 1495CD-AC1      | 7314150296965 | 1 | 453 |
| 1495CD60        | 7314150296927 | 1 | 450 |
| 1495CD60TS1     | 7314150325627 | 1 | 448 |
| 1495CD60W       | 7314150303656 | 1 | 451 |
| 1495CS-AC1      | 7314150296910 | 1 | 453 |
| 1495CS15        | 7314150296934 | 1 | 450 |
| 1495CS15BL      | 7314150326860 | 1 | 450 |
| 1495CS15TS1     | 7314150325610 | 1 | 448 |
| 1495CS18        | 7314150296941 | 1 | 450 |
| 1495CS18BL      | 7314150326891 | 1 | 450 |
| 1495CS18BLHK    | 7314150407620 | 1 | 450 |
| 1495CS18HK      | 7314150407613 | 1 | 450 |
| 1495CS18TS1     | 7314150325603 | 1 | 448 |
| 1495FWB097TD    | 7314150296675 | 1 | 456 |
| 1495FWB120TD    | 7314150296682 | 1 | 456 |
| 1495FWB120TS    | 7314150296668 | 1 | 456 |
| 1495K6CBKWB15TS | 7314150368990 | 1 | 455 |
| 1495K6CBKWB15TW | 7314150369034 | 1 | 455 |
| 1495K6CBKWB18TS | 7314150369591 | 1 | 454 |
| 1495K6CBKWB18TW | 7314150369638 | 1 | 455 |
| 1495K6CBLWB15TS | 7314150369119 | 1 | 455 |
| 1495K6CBLWB15TW | 7314150369232 | 1 | 455 |
| 1495K6CBLWB18TS | 7314150369744 | 1 | 454 |
| 1495K6CBLWB18TW | 7314150369782 | 1 | 455 |
| 1495K6CRDWB15TS | 7314150368600 | 1 | 455 |
| 1495K6CRDWB15TW | 7314150368655 | 1 | 455 |
| 1495K6CRDWB18TS | 7314150369478 | 1 | 454 |
| 1495K6CRDWB18TW | 7314150369515 | 1 | 455 |
| 1495K6CWB15TS   | 7314150368440 | 1 | 455 |
| 1495K6CWB15TW   | 7314150368501 | 1 | 455 |



|                 |               |   |     |
|-----------------|---------------|---|-----|
| 1495K6CWB18TS   | 7314150369355 | 1 | 454 |
| 1495K6CWB18TW   | 7314150369393 | 1 | 455 |
| 1495K7CBKWB15TS | 7314150369003 | 1 | 455 |
| 1495K7CBKWB15TW | 7314150369041 | 1 | 455 |
| 1495K7CBKWB18TS | 7314150369607 | 1 | 454 |
| 1495K7CBKWB18TW | 7314150369645 | 1 | 455 |
| 1495K7CBLWB15TS | 7314150369164 | 1 | 455 |
| 1495K7CBLWB15TW | 7314150369263 | 1 | 455 |
| 1495K7CBLWB18TS | 7314150369751 | 1 | 454 |
| 1495K7CBLWB18TW | 7314150369799 | 1 | 455 |
| 1495K7CRDWB15TS | 7314150368624 | 1 | 455 |
| 1495K7CRDWB15TW | 7314150368662 | 1 | 455 |
| 1495K7CRDWB18TS | 7314150369485 | 1 | 454 |
| 1495K7CRDWB18TW | 7314150369522 | 1 | 455 |
| 1495K7CWB15TS   | 7314150368464 | 1 | 455 |
| 1495K7CWB15TW   | 7314150368518 | 1 | 455 |
| 1495K7CWB18TS   | 7314150369362 | 1 | 454 |
| 1495K7CWB18TW   | 7314150369409 | 1 | 455 |
| 1495K8CBKWB15TS | 7314150369010 | 1 | 455 |
| 1495K8CBKWB15TW | 7314150369058 | 1 | 455 |
| 1495K8CBKWB18TS | 7314150369614 | 1 | 454 |
| 1495K8CBKWB18TW | 7314150369652 | 1 | 455 |
| 1495K8CBLWB15TS | 7314150369188 | 1 | 455 |
| 1495K8CBLWB15TW | 7314150369294 | 1 | 455 |
| 1495K8CBLWB18TS | 7314150369768 | 1 | 454 |
| 1495K8CBLWB18TW | 7314150369805 | 1 | 455 |
| 1495K8CRDWB15TS | 7314150368631 | 1 | 455 |
| 1495K8CRDWB15TW | 7314150368693 | 1 | 455 |
| 1495K8CRDWB18TS | 7314150369492 | 1 | 454 |
| 1495K8CRDWB18TW | 7314150369539 | 1 | 455 |
| 1495K8CWB15TS   | 7314150368471 | 1 | 455 |
| 1495K8CWB15TW   | 7314150368525 | 1 | 455 |
| 1495K8CWB18TS   | 7314150370061 | 1 | 454 |
| 1495K8CWB18TW   | 7314150369416 | 1 | 455 |
| 1495KWB15TS     | 7314150338115 | 1 | 455 |
| 1495KWB15TW     | 7314150296613 | 1 | 455 |
| 1495KWB18TS     | 7314150338122 | 1 | 455 |
| 1495KWB18TW     | 7314150296620 | 1 | 455 |
| 1495TP-AC1      | 7314150297030 | 1 | 453 |
| 1495TP-AC10     | 7314150297207 | 1 | 453 |
| 1495TP-AC11     | 7314150297214 | 1 | 453 |
| 1495TP-AC12     | 7314150297221 | 1 | 453 |
| 1495TP-AC13     | 7314150297238 | 1 | 453 |
| 1495TP-AC2      | 7314150297122 | 1 | 453 |
| 1495TP-AC3      | 7314150297139 | 1 | 454 |
| 1495TP-AC4      | 7314150297146 | 1 | 454 |
| 1495TP-AC5      | 7314150297153 | 1 | 454 |
| 1495TP-AC6      | 7314150297160 | 1 | 454 |
| 1495TP-AC7      | 7314150297177 | 1 | 454 |
| 1495TP-AC8      | 7314150297184 | 1 | 454 |
| 1495TP-AC9      | 7314150297191 | 1 | 454 |
| 1495TP-ACHL20   | 7314150297047 | 1 | 454 |
| 1495TP-ACHL40   | 7314150297054 | 1 | 454 |
| 1495TP-ACHL65   | 7314150297061 | 1 | 454 |
| 1495TP-ACHL90   | 7314150297078 | 1 | 454 |
| 1495TP-ACHU20   | 7314150297085 | 1 | 454 |
| 1495TP-ACHU40   | 7314150297092 | 1 | 454 |
| 1495TP-ACHU65   | 7314150297108 | 1 | 454 |
| 1495TP-ACHU90   | 7314150297115 | 1 | 454 |
| 1495TP-AUTO-M1  | 7314150438266 | 1 | 451 |
| 1495TP-AUTO-M2  | 7314150438273 | 1 | 451 |
| 1495TP-AUTO-M3  | 7314150438280 | 1 | 451 |
| 1495TP-AUTO-M4  | 7314150438297 | 1 | 452 |
| 1495TP-AUTO-M5  | 7314150438303 | 1 | 452 |
| 1495TP-AUTO-M6  | 7314150438310 | 1 | 452 |
| 1495TP06        | 7314150296989 | 1 | 452 |
| 1495TP06GR      | 7314150326914 | 1 | 452 |
| 1495TP09        | 7314150438624 | 1 | 452 |
| 1495TP09-RAIL   | 7314150465705 | 1 | 453 |
| 1495TP12        | 7314150296996 | 1 | 452 |
| 1495TP12GR      | 7314150326921 | 1 | 452 |
| 1495TP15        | 7314150297009 | 1 | 452 |
| 1495TP18        | 7314150297016 | 1 | 452 |
| 1495TP18GR      | 7314150326945 | 1 | 452 |
| 1495WB-AC1      | 7314150296576 | 1 | 456 |
| 1495WB15-AC1    | 7314150296590 | 1 | 456 |
| 1495WB15TS      | 7314150296514 | 1 | 456 |
| 1495WB15TSBL    | 7314150326990 | 1 | 456 |
| 1495WB15TSBT    | 7314150407651 | 1 | 455 |
| 1495WB15TSRED   | 7314150327003 | 1 | 456 |
| 1495WB15TW      | 7314150296538 | 1 | 456 |
| 1495WB15TWGR    | 7314150327140 | 1 | 456 |
| 1495WB18-AC1    | 7314150296606 | 1 | 456 |
| 1495WB18TS      | 7314150296545 | 1 | 456 |
| 1495WB18TSBK    | 7314150327010 | 1 | 456 |
| 1495WB18TSBL    | 7314150327027 | 1 | 456 |
| 1495WB18TSBLBT  | 7314150407644 | 1 | 455 |
| 1495WB18TSBT    | 7314150407637 | 1 | 455 |
| 1495WB18TSRED   | 7314150327034 | 1 | 456 |
| 1495WB18TW      | 7314150296569 | 1 | 456 |
| 1495WB18TWGR    | 7314150327164 | 1 | 456 |
| 1496MB2         | 7314150273478 | 1 | 462 |
| 1496MB3         | 7314150273485 | 1 | 462 |
| 1496MB4         | 7314150273492 | 1 | 462 |
| 1496MB5         | 7314150273508 | 1 | 462 |
| 1497MBF350      | 7314150321391 | 1 | 461 |



|                 |               |    |     |
|-----------------|---------------|----|-----|
| 1497MBF550      | 7314150321407 | 1  | 461 |
| 1497MBF750      | 7314150321414 | 1  | 461 |
| 1497MBW         | 7314150330164 | 1  | 461 |
| 14A-32          | 7314150368228 | 1  | 119 |
| 14A-9           | 7314150368211 | 1  | 119 |
| 14F-1/2         | 7314150366200 | 1  | 116 |
| 14F-3/4         | 7314150366217 | 1  | 116 |
| 14P-1/2         | 7314150366064 | 1  | 116 |
| 14Q-1/2         | 7314150366026 | 1  | 116 |
| 14R-1/2         | 7314150365920 | 1  | 115 |
| 14R-3/4         | 7314150365937 | 1  | 115 |
| 14T-1/2         | 7314150366125 | 1  | 116 |
| 14T-3/4         | 7314150366132 | 1  | 116 |
| 14W             | 7314150357031 | 1  | 119 |
| 1519 D          | 7314150032747 | 3  | 237 |
| 1519-9          | 7314150026074 | 1  | 237 |
| 1520 D          | 7311518278922 | 5  | 233 |
| 1520 G          | 7311518266516 | 5  | 233 |
| 1520 G IP       | 7314150437740 | 5  | 233 |
| 1535            | 7314150214808 | 1  | 545 |
| 1537            | 7314150214822 | 1  | 545 |
| 1544            | 7311518276560 | 1  | 545 |
| 1546            | 7314150214792 | 1  | 545 |
| 1547            | 7311518276577 | 20 | 545 |
| 158-N           | 7311518277239 | 12 | 242 |
| 158-NB          | 7311518277246 | 12 | 244 |
| 1610            | 7314150404186 | 1  | 266 |
| 1610-NUT        | 7314150409594 | 1  | 266 |
| 1620            | 7314150404193 | 1  | 266 |
| 1620-NUT        | 7314150409754 | 1  | 266 |
| 166-6-16-2.5-12 | 7311518021979 | 12 | 26  |
| 166-6-16-2.5-2  | 7311518209698 | 5  | 26  |
| 167-1           | 7314150419067 | 1  | 120 |
| 167-1.1/16      | 7314150419074 | 1  | 120 |
| 167-1.1/4       | 7314150419104 | 1  | 120 |
| 167-1.1/8       | 7314150419081 | 1  | 120 |
| 167-1.3/16      | 7314150419098 | 1  | 120 |
| 167-1/2         | 7314150418930 | 1  | 120 |
| 167-10          | 7314150418657 | 1  | 120 |
| 167-11          | 7314150418664 | 1  | 120 |
| 167-11/16       | 7314150419364 | 1  | 120 |
| 167-12          | 7314150418671 | 1  | 120 |
| 167-13          | 7314150418688 | 1  | 120 |
| 167-13/16       | 7314150419036 | 1  | 120 |
| 167-14          | 7314150418695 | 1  | 120 |
| 167-15          | 7314150418701 | 1  | 120 |
| 167-15/16       | 7314150419050 | 1  | 120 |
| 167-16          | 7314150418718 | 1  | 120 |
| 167-17          | 7314150418725 | 1  | 120 |
| 167-18          | 7314150418732 | 1  | 120 |
| 167-19          | 7314150418749 | 1  | 120 |
| 167-20          | 7314150418763 | 1  | 120 |
| 167-21          | 7314150418770 | 1  | 120 |
| 167-22          | 7314150418787 | 1  | 120 |
| 167-23          | 7314150418794 | 1  | 120 |
| 167-24          | 7314150418800 | 1  | 120 |
| 167-25          | 7314150418817 | 1  | 120 |
| 167-26          | 7314150418824 | 1  | 120 |
| 167-27          | 7314150418831 | 1  | 120 |
| 167-28          | 7314150418848 | 1  | 120 |
| 167-3/4         | 7314150419029 | 1  | 120 |
| 167-3/8         | 7314150418909 | 1  | 120 |
| 167-30          | 7314150418855 | 1  | 120 |
| 167-32          | 7314150418862 | 1  | 120 |
| 167-36          | 7314150418886 | 1  | 120 |
| 167-5/16        | 7314150418893 | 1  | 120 |
| 167-5/8         | 7314150419012 | 1  | 120 |
| 167-7           | 7314150418619 | 1  | 120 |
| 167-7/16        | 7314150418916 | 1  | 120 |
| 167-7/8         | 7314150419043 | 1  | 120 |
| 167-8           | 7314150418626 | 1  | 120 |
| 167-8-21-3.2-12 | 7311518021986 | 12 | 26  |
| 167-9           | 7314150418640 | 1  | 120 |
| 167-9/16        | 7314150419005 | 1  | 120 |
| 168-1           | 7314150419562 | 1  | 121 |
| 168-1.1/16      | 7314150419579 | 1  | 121 |
| 168-1.3/16      | 7314150419586 | 1  | 121 |
| 168-1/2         | 7314150419487 | 1  | 121 |
| 168-10          | 7314150419272 | 1  | 121 |
| 168-11          | 7314150419289 | 1  | 121 |
| 168-11/16       | 7314150419517 | 1  | 121 |
| 168-12          | 7314150419296 | 1  | 120 |
| 168-13          | 7314150419302 | 1  | 121 |
| 168-13/16       | 7314150419531 | 1  | 121 |
| 168-14          | 7314150419319 | 1  | 121 |
| 168-15          | 7314150419326 | 1  | 121 |
| 168-15/16       | 7314150419555 | 1  | 121 |
| 168-16          | 7314150419333 | 1  | 121 |
| 168-17          | 7314150419340 | 1  | 121 |
| 168-18          | 7314150419357 | 1  | 121 |
| 168-19          | 7314150419371 | 1  | 121 |
| 168-20          | 7314150419388 | 1  | 121 |
| 168-21          | 7314150419395 | 1  | 121 |
| 168-22          | 7314150419401 | 1  | 121 |
| 168-23          | 7314150419418 | 1  | 121 |
| 168-24          | 7314150419425 | 1  | 121 |







|                    |               |    |     |
|--------------------|---------------|----|-----|
| 168-26             | 7314150419432 | 1  | 121 |
| 168-27             | 7314150419449 | 1  | 121 |
| 168-3/4            | 7314150419524 | 1  | 121 |
| 168-3/8            | 7314150419463 | 1  | 121 |
| 168-5/16           | 7314150419456 | 1  | 121 |
| 168-5/8            | 7314150419500 | 1  | 121 |
| 168-6-3.2-1P       | 7311518152338 | 12 | 26  |
| 168-6-3.2-3P       | 7311518152413 | 12 | 27  |
| 168-6-3.5-1P       | 7311518152345 | 12 | 26  |
| 168-6-3.5-3P       | 7311518152420 | 12 | 27  |
| 168-7              | 7314150419241 | 1  | 120 |
| 168-7/16           | 7314150419470 | 1  | 121 |
| 168-7/8            | 7314150419548 | 1  | 121 |
| 168-8              | 7314150419258 | 1  | 120 |
| 168-8-4.0-1P       | 7311518152352 | 12 | 26  |
| 168-8-4.0-3P       | 7311518152437 | 12 | 27  |
| 168-8-4.0-6        | 7311518217419 | 6  | 27  |
| 168-8-4.5-1P       | 7311518152369 | 12 | 26  |
| 168-8-4.5-3P       | 7311518152444 | 12 | 27  |
| 168-8-4.5-6        | 7311518217426 | 6  | 27  |
| 168-8-4.8-1P       | 7311518152376 | 12 | 26  |
| 168-8-4.8-3P       | 7311518152451 | 12 | 27  |
| 168-8-4.8-6        | 7311518217433 | 6  | 27  |
| 168-8-5.2-1P       | 7311518152383 | 12 | 26  |
| 168-8-5.2-3P       | 7311518152468 | 12 | 27  |
| 168-8-5.2-6        | 7311518217440 | 6  | 27  |
| 168-8-5.5-1P       | 7311518152390 | 12 | 26  |
| 168-8-5.5-3P       | 7311518152475 | 12 | 27  |
| 168-8-5.5-6        | 7311518217457 | 6  | 27  |
| 168-8-6.3-1P       | 7311518152406 | 12 | 26  |
| 168-8-6.3-3P       | 7311518152482 | 12 | 27  |
| 168-9              | 7314150419265 | 1  | 120 |
| 168-9/16           | 7314150419494 | 1  | 121 |
| 168-COMBI-4.0      | 7311518209667 | 10 | 27  |
| 168-COMBI-4.0-6922 | 7311518209612 | 10 | 27  |
| 168-COMBI-4.5      | 7314150272860 | 10 | 27  |
| 168-COMBI-4.8      | 7311518209674 | 10 | 27  |
| 168-COMBI-4.8-6920 | 7311518209643 | 10 | 27  |
| 168-COMBI-5.5      | 7311518209681 | 10 | 27  |
| 168-COMBI-5.5-6924 | 7311518209650 | 10 | 27  |
| 169-10             | 7314150419630 | 1  | 121 |
| 169-11             | 7314150419647 | 1  | 121 |
| 169-12             | 7314150419654 | 1  | 121 |
| 169-13             | 7314150419661 | 1  | 121 |
| 169-14             | 7314150419678 | 1  | 121 |
| 169-15             | 7314150419715 | 1  | 121 |
| 169-16             | 7314150419722 | 1  | 121 |
| 169-17             | 7314150419739 | 1  | 121 |
| 169-18             | 7314150419746 | 1  | 121 |
| 169-19             | 7314150419753 | 1  | 121 |
| 169-20             | 7314150419760 | 1  | 121 |
| 169-21             | 7314150419777 | 1  | 121 |
| 169-22             | 7314150419784 | 1  | 121 |
| 169-23             | 7314150419791 | 1  | 121 |
| 169-24             | 7314150419807 | 1  | 121 |
| 169-27             | 7314150419814 | 1  | 121 |
| 169-7              | 7314150419609 | 1  | 121 |
| 169-8              | 7314150419616 | 1  | 121 |
| 169-9              | 7314150419623 | 1  | 121 |
| 16F-1/2            | 7314150418565 | 1  | 119 |
| 16F-1/4            | 7314150418541 | 1  | 119 |
| 16F-3/8            | 7314150418558 | 1  | 119 |
| 16R-1/2            | 7314150418602 | 1  | 119 |
| 16R-1/4            | 7314150418589 | 1  | 119 |
| 16R-3/8            | 7314150418596 | 1  | 119 |
| 1931M-10           | 7314151049256 | 5  | 49  |
| 1931M-11           | 7314151049263 | 5  | 49  |
| 1931M-12           | 7314151049270 | 5  | 49  |
| 1931M-13           | 7314151049287 | 5  | 49  |
| 1931M-14           | 7314151049294 | 5  | 49  |
| 1931M-17           | 7314151049324 | 5  | 49  |
| 1931M-4            | 7314151049171 | 5  | 49  |
| 1931M-4.5          | 7314151049188 | 5  | 49  |
| 1931M-5            | 7314151049195 | 5  | 49  |
| 1931M-5.5          | 7314151049201 | 5  | 49  |
| 1931M-6            | 7314151049218 | 5  | 49  |
| 1931M-7            | 7314151049225 | 5  | 49  |
| 1931M-8            | 7314151049232 | 5  | 49  |
| 1931M-9            | 7314151049249 | 5  | 49  |
| 1931M/10T          | 7314151049409 | 1  | 50  |
| 1931Z-1/2          | 7314151049775 | 5  | 49  |
| 1931Z-1/4          | 7314151049713 | 5  | 49  |
| 1931Z-1/8          | 7314150371563 | 5  | 49  |
| 1931Z-11/32        | 7314151049744 | 5  | 49  |
| 1931Z-11/32-3/8    | 7314150371624 | 5  | 49  |
| 1931Z-13/64        | 7314151049683 | 5  | 49  |
| 1931Z-15/64-1/4    | 7314150371570 | 5  | 49  |
| 1931Z-3/16         | 7314151049676 | 5  | 49  |
| 1931Z-3/8          | 7314151049751 | 5  | 49  |
| 1931Z-5/16         | 7314151049737 | 5  | 49  |
| 1931Z-5/32         | 7314151049669 | 5  | 49  |
| 1931Z-5/8          | 7314151049799 | 5  | 49  |
| 1931Z-7/16         | 7314151049768 | 5  | 49  |
| 1931Z-7/32         | 7314151049690 | 5  | 49  |
| 1931Z-9/16         | 7314151049782 | 5  | 49  |
| 1931Z-9/32         | 7314151049720 | 5  | 49  |



|                   |               |    |     |
|-------------------|---------------|----|-----|
| 1931Z-9/32-5/16   | 7314150371600 | 5  | 49  |
| 1931Z/12T         | 7314150107674 | 1  | 50  |
| 1933M/6T          | 7314151821654 | 1  | 50  |
| 1936M-10-11       | 7314151051402 | 25 | 58  |
| 1936M-10-13       | 7314151344146 | 25 | 58  |
| 1936M-12-13       | 7314151051419 | 25 | 58  |
| 1936M-13-17       | 7314151830144 | 20 | 58  |
| 1936M-14-15       | 7314151051426 | 20 | 58  |
| 1936M-14-17       | 7314151051129 | 15 | 58  |
| 1936M-16-17       | 7314151051433 | 15 | 58  |
| 1936M-17-19       | 7314151051136 | 10 | 58  |
| 1936M-18-19       | 7314151051440 | 10 | 58  |
| 1936M-19-22       | 7314151051150 | 8  | 58  |
| 1936M-20-22       | 7314151830151 | 8  | 58  |
| 1936M-21-23       | 7314151830168 | 8  | 58  |
| 1936M-22-24       | 7314151830175 | 5  | 58  |
| 1936M-24-26       | 7314151830182 | 5  | 58  |
| 1936M-24-27       | 7314151051181 | 5  | 58  |
| 1936M-25-28       | 7314151830199 | 5  | 58  |
| 1936M-30-32       | 7314151051501 | 1  | 58  |
| 1936M-30-34       | 7314151838577 | 4  | 58  |
| 1936M-36-41       | 7314151830205 | 4  | 58  |
| 1936M-46-50       | 7314151830212 | 2  | 58  |
| 1936M-6-7         | 7314151051389 | 50 | 58  |
| 1936M-8-10        | 7314151830137 | 30 | 58  |
| 1936M-8-9         | 7314151051396 | 5  | 58  |
| 1936M/12          | 7314151830250 | 1  | 58  |
| 1936M/7           | 7314151830243 | 1  | 58  |
| 1943M-11-13       | 7314151052829 | 1  | 53  |
| 1943M-13-15       | 7314151804732 | 1  | 53  |
| 1943M-13-17       | 7314151804749 | 1  | 53  |
| 1943M-14-17       | 7314151052843 | 1  | 53  |
| 1943M-15-17       | 7314151052850 | 1  | 53  |
| 1943M-19-22       | 7314151052867 | 1  | 53  |
| 1943Z-11/16-13/16 | 7314150355174 | 1  | 53  |
| 1943Z-5/16-3/8    | 7314150355136 | 1  | 53  |
| 1943Z-5/8-3/4     | 7314150355167 | 1  | 53  |
| 1943Z-7/16-1/2    | 7314150355143 | 1  | 53  |
| 1943Z-9/16-5/8    | 7314150355150 | 1  | 53  |
| 1945W/12          | 7314150352289 | 6  | 316 |
| 1945W/14          | 7314150352265 | 8  | 316 |
| 1945W/38          | 7314150352272 | 6  | 316 |
| 1949M-10-11       | 7314151055394 | 1  | 54  |
| 1949M-10-12       | 7314151055400 | 1  | 54  |
| 1949M-12-13       | 7314151055417 | 1  | 54  |
| 1949M-12-14       | 7314151055424 | 1  | 54  |
| 1949M-14-15       | 7314151304546 | 1  | 54  |
| 1949M-14-17       | 7314151055448 | 1  | 54  |
| 1949M-17-19       | 7314151055455 | 1  | 54  |
| 1949M-19-22       | 7314151055462 | 1  | 54  |
| 1949M-22-24       | 7314151304553 | 1  | 54  |
| 1949M-24-27       | 7314151055479 | 1  | 54  |
| 1949M-30-32       | 7314151304577 | 1  | 54  |
| 1949M-8-9         | 7314151304539 | 1  | 54  |
| 1949Z-1-1.1/8     | 7314151055547 | 1  | 54  |
| 1949Z-1/2-9/16    | 7314151055509 | 1  | 54  |
| 1949Z-3/4-7/8     | 7314151055530 | 1  | 54  |
| 1949Z-3/8-7/16    | 7314151055486 | 1  | 54  |
| 1949Z-5/8-3/4     | 7314151055523 | 1  | 54  |
| 1950M/3-8         | 7314150130207 | 1  | 55  |
| 1952M-10          | 7314151057213 | 10 | 43  |
| 1952M-11          | 7314151057220 | 10 | 43  |
| 1952M-12          | 7314151057237 | 10 | 43  |
| 1952M-13          | 7314151057244 | 10 | 43  |
| 1952M-14          | 7314151057251 | 10 | 43  |
| 1952M-15          | 7314151057268 | 10 | 43  |
| 1952M-16          | 7314151057275 | 10 | 43  |
| 1952M-17          | 7314151057282 | 10 | 43  |
| 1952M-18          | 7314151057299 | 10 | 43  |
| 1952M-19          | 7314151057305 | 10 | 43  |
| 1952M-20          | 7314151057312 | 10 | 43  |
| 1952M-21          | 7314151057329 | 10 | 43  |
| 1952M-22          | 7314151057336 | 5  | 43  |
| 1952M-23          | 7314151057343 | 5  | 43  |
| 1952M-24          | 7314151057350 | 5  | 43  |
| 1952M-25          | 7314151057367 | 5  | 43  |
| 1952M-26          | 7314151057374 | 5  | 43  |
| 1952M-27          | 7314151057381 | 5  | 43  |
| 1952M-28          | 7314151057398 | 1  | 43  |
| 1952M-29          | 7314151325763 | 1  | 43  |
| 1952M-30          | 7314151057404 | 1  | 43  |
| 1952M-32          | 7314151057411 | 1  | 43  |
| 1952M-34          | 7314151838553 | 1  | 43  |
| 1952M-36          | 7314151057428 | 1  | 43  |
| 1952M-41          | 7314151057435 | 1  | 43  |
| 1952M-46          | 7314151840105 | 1  | 43  |
| 1952M-50          | 7314151840112 | 1  | 43  |
| 1952M-55          | 7314151840129 | 1  | 43  |
| 1952M-6           | 7314151057176 | 10 | 43  |
| 1952M-60          | 7314151840136 | 1  | 43  |
| 1952M-65          | 7314150135226 | 1  | 43  |
| 1952M-7           | 7314151057183 | 10 | 43  |
| 1952M-70          | 7314150135301 | 1  | 43  |
| 1952M-75          | 7314150135325 | 1  | 43  |
| 1952M-8           | 7314151057190 | 10 | 43  |
| 1952M-80          | 7314150135509 | 1  | 43  |



|              |               |    |     |
|--------------|---------------|----|-----|
| 1952M-9      | 7314151057206 | 10 | 43  |
| 1952M/10     | 7314151057688 | 1  | 44  |
| 1952M/14T    | 7314151057695 | 1  | 44  |
| 1952M/17T    | 7314151057473 | 1  | 44  |
| 1952M/26T    | 7314151057701 | 1  | 44  |
| 1952M/7T     | 7314151806637 | 1  | 44  |
| 1952M/SH12   | 7314153013330 | 1  | 44  |
| 1952M/SH6    | 7314153013286 | 1  | 44  |
| 1952Z-1      | 7314151057602 | 1  | 43  |
| 1952Z-1.1/16 | 7314151057619 | 1  | 43  |
| 1952Z-1.1/2  | 7314151057756 | 1  | 43  |
| 1952Z-1.1/4  | 7314151057633 | 1  | 43  |
| 1952Z-1.1/8  | 7314151057626 | 1  | 43  |
| 1952Z-1.3/8  | 7314151057732 | 1  | 43  |
| 1952Z-1.5/16 | 7314151057718 | 1  | 43  |
| 1952Z-1.5/8  | 7314151057763 | 1  | 43  |
| 1952Z-1.7/16 | 7314151057749 | 1  | 43  |
| 1952Z-1/2    | 7314151057527 | 5  | 43  |
| 1952Z-1/4    | 7314151057480 | 5  | 43  |
| 1952Z-11/16  | 7314151057558 | 5  | 43  |
| 1952Z-11/32  | 7314150111046 | 5  | 43  |
| 1952Z-13/16  | 7314151057572 | 5  | 43  |
| 1952Z-15/16  | 7314151057596 | 5  | 43  |
| 1952Z-3/4    | 7314151057565 | 5  | 43  |
| 1952Z-3/8    | 7314151057503 | 5  | 43  |
| 1952Z-5/16   | 7314151057497 | 5  | 43  |
| 1952Z-5/8    | 7314151057541 | 5  | 43  |
| 1952Z-7/16   | 7314151057510 | 5  | 43  |
| 1952Z-7/8    | 7314151057589 | 5  | 43  |
| 1952Z-9/16   | 7314151057534 | 5  | 43  |
| 1952Z/11T    | 7314151057725 | 1  | 45  |
| 1976TORX-T10 | 7314150123438 | 5  | 228 |
| 1976TORX-T15 | 7314150123452 | 5  | 228 |
| 1976TORX-T20 | 7314150123469 | 5  | 228 |
| 1976TORX-T25 | 7314150123476 | 5  | 228 |
| 1976TORX-T27 | 7314150123490 | 5  | 228 |
| 1976TORX-T30 | 7314150123506 | 5  | 228 |
| 1976TORX-T40 | 7314150123513 | 5  | 228 |
| 1976TORX-T6  | 7314150122240 | 5  | 228 |
| 1976TORX-T7  | 7314150123384 | 5  | 228 |
| 1976TORX-T8  | 7314150123391 | 5  | 228 |
| 1976TORX-T9  | 7314150123414 | 5  | 228 |
| 1976TORX/5T  | 7314150126927 | 1  | 228 |
| 1986TORX-T10 | 7314150123537 | 5  | 228 |
| 1986TORX-T15 | 7314150123544 | 5  | 228 |
| 1986TORX-T20 | 7314150123551 | 5  | 228 |
| 1986TORX-T25 | 7314150123568 | 5  | 228 |
| 1986TORX-T27 | 7314150123575 | 5  | 228 |
| 1986TORX-T30 | 7314150123582 | 5  | 228 |
| 1986TORX-T40 | 7314150123599 | 5  | 228 |
| 1986TORX-T9  | 7314150122233 | 5  | 228 |
| 1986TORX/7T  | 7314150123735 | 1  | 228 |
| 1995LM-1.5   | 7314150122172 | 10 | 224 |
| 1995LM-10    | 7314150123254 | 10 | 224 |
| 1995LM-12    | 7314150123261 | 10 | 224 |
| 1995LM-14    | 7314150123278 | 10 | 224 |
| 1995LM-2     | 7314150122189 | 10 | 224 |
| 1995LM-2.5   | 7314150123162 | 10 | 224 |
| 1995LM-3     | 7314150123179 | 10 | 224 |
| 1995LM-4     | 7314150123186 | 10 | 224 |
| 1995LM-5     | 7314150123209 | 10 | 224 |
| 1995LM-6     | 7314150123216 | 10 | 224 |
| 1995LM-7     | 7314150123223 | 10 | 224 |
| 1995LM-8     | 7314150123230 | 10 | 224 |
| 1995LM-9     | 7314150123247 | 10 | 224 |
| 1995M-0.9    | 7314150216291 | 10 | 223 |
| 1995M-1.5    | 7314150122158 | 10 | 223 |
| 1995M-10     | 7314150122912 | 10 | 223 |
| 1995M-12     | 7314150122943 | 10 | 223 |
| 1995M-14     | 7314150122967 | 10 | 223 |
| 1995M-17     | 7314150122974 | 10 | 223 |
| 1995M-19     | 7314150122981 | 10 | 223 |
| 1995M-2      | 7314150122745 | 10 | 223 |
| 1995M-2.5    | 7314150122752 | 10 | 223 |
| 1995M-22     | 7314150122998 | 10 | 223 |
| 1995M-3      | 7314150122769 | 10 | 223 |
| 1995M-4      | 7314150122776 | 10 | 223 |
| 1995M-5      | 7314150122790 | 10 | 223 |
| 1995M-6      | 7314150122813 | 10 | 223 |
| 1995M-7      | 7314150122837 | 10 | 223 |
| 1995M-8      | 7314150122851 | 10 | 223 |
| 1995M-9      | 7314150122875 | 10 | 223 |
| 1995M/10T    | 7314150123643 | 1  | 223 |
| 1995M/11T    | 7314150123650 | 1  | 223 |
| 1995M/15T    | 7314150123667 | 1  | 223 |
| 1995M/6T     | 7314150123629 | 1  | 223 |
| 1995M/8T     | 7314150123636 | 1  | 223 |
| 1995TORX-T10 | 7314150123308 | 5  | 226 |
| 1995TORX-T15 | 7314150123322 | 5  | 226 |
| 1995TORX-T20 | 7314150123339 | 5  | 226 |
| 1995TORX-T25 | 7314150123346 | 5  | 226 |
| 1995TORX-T27 | 7314150123353 | 5  | 226 |
| 1995TORX-T30 | 7314150123360 | 5  | 226 |
| 1995TORX-T40 | 7314150123377 | 5  | 226 |
| 1995TORX-T45 | 7314150123407 | 5  | 226 |
| 1995TORX-T50 | 7314150123421 | 5  | 226 |



|              |                |    |     |
|--------------|----------------|----|-----|
| 1995TORX-T55 | 7314150216963  | 5  | 226 |
| 1995TORX-T6  | 7314150122196  | 5  | 226 |
| 1995TORX-T60 | 7314150216970  | 5  | 226 |
| 1995TORX-T7  | 7314150123285  | 5  | 226 |
| 1995TORX-T8  | 7314150123292  | 5  | 226 |
| 1995TORX-T9  | 7314150122219  | 5  | 226 |
| 1995TORX/11T | 7314150123742  | 1  | 227 |
| 1995TORX/13T | 7314150123759  | 1  | 227 |
| 1995TORX/4T  | 7314150123674  | 1  | 226 |
| 1995TORX/7T  | 7314150123711  | 1  | 226 |
| 1995Z-1/16   | 7314150122165  | 10 | 223 |
| 1995Z-1/2    | 7314150123117  | 10 | 223 |
| 1995Z-1/4    | 7314150123070  | 10 | 223 |
| 1995Z-1/8    | 7314150123025  | 10 | 223 |
| 1995Z-3/16   | 7314150123056  | 10 | 223 |
| 1995Z-3/32   | 7314150123018  | 10 | 223 |
| 1995Z-3/4    | 7314150123155  | 10 | 223 |
| 1995Z-3/8    | 7314150123094  | 10 | 223 |
| 1995Z-5/16   | 7314150123087  | 10 | 223 |
| 1995Z-5/32   | 7314150123049  | 10 | 223 |
| 1995Z-5/64   | 7314150123001  | 10 | 223 |
| 1995Z-5/8    | 7314150123131  | 10 | 223 |
| 1995Z-7/16   | 7314150123100  | 10 | 223 |
| 1995Z-7/32   | 7314150123063  | 10 | 223 |
| 1995Z/10T    | 7314150215980  | 1  | 224 |
| 1995Z/12T    | 7314150215997  | 1  | 224 |
| 1996M-1.5    | 7314150122202  | 10 | 225 |
| 1996M-10     | 7314150122721  | 10 | 225 |
| 1996M-12     | 7314150122738  | 5  | 225 |
| 1996M-2      | 7314150122653  | 10 | 225 |
| 1996M-2.5    | 7314150122660  | 10 | 225 |
| 1996M-3      | 7314150122677  | 10 | 225 |
| 1996M-4      | 7314150122684  | 10 | 225 |
| 1996M-5      | 7314150122691  | 10 | 225 |
| 1996M-6      | 7314150122707  | 10 | 225 |
| 1996M-8      | 7314150122714  | 10 | 225 |
| 1996TORX-T10 | 7314150122783  | 5  | 227 |
| 1996TORX-T15 | 7314150122806  | 5  | 227 |
| 1996TORX-T20 | 7314150122820  | 5  | 227 |
| 1996TORX-T25 | 7314150122844  | 5  | 227 |
| 1996TORX-T27 | 7314150122868  | 5  | 227 |
| 1996TORX-T30 | 7314150122882  | 5  | 227 |
| 1996TORX-T40 | 7314150122899  | 5  | 227 |
| 1996TORX-T45 | 7314150122905  | 5  | 227 |
| 1996TORX-T50 | 7314150122929  | 5  | 227 |
| 1996TORX-T9  | 7314150122226  | 5  | 227 |
| 1996TORX/5T  | 7314150123698  | 1  | 227 |
| 1998M-1.5    | 7314150185719  | 10 | 222 |
| 1998M-10     | 7314150185801  | 10 | 222 |
| 1998M-12     | 7314150185818  | 5  | 222 |
| 1998M-14     | 7314150185825  | 1  | 222 |
| 1998M-17     | 7314150185832  | 1  | 222 |
| 1998M-19     | 7314150185849  | 1  | 222 |
| 1998M-2      | 7314150185726  | 10 | 222 |
| 1998M-2.5    | 7314150185733  | 10 | 222 |
| 1998M-22     | 7314150185856  | 1  | 222 |
| 1998M-3      | 7314150185740  | 10 | 222 |
| 1998M-4      | 7314150185757  | 10 | 222 |
| 1998M-5      | 7314150185764  | 10 | 222 |
| 1998M-6      | 7314150185863  | 10 | 222 |
| 1998M-7      | 7314150185771  | 10 | 222 |
| 1998M-8      | 7314150185788  | 10 | 222 |
| 1998M-9      | 7314150185795  | 5  | 222 |
| 1998M/10T    | 7314150186228  | 1  | 222 |
| 1998M/11T    | 7314150186235  | 1  | 222 |
| 1998M/15T    | 7314150186242  | 1  | 222 |
| 1998M/6T     | 7314150186204  | 1  | 222 |
| 1998M/8R     | 7314150186266  | 1  | 222 |
| 1998M/8T     | 7314150186211  | 1  | 222 |
| 1999M/7H     | 7314151801076  | 1  | 502 |
| 1999MV-10    | 7314150121496  | 3  | 502 |
| 1999MV-12    | 7314150121502  | 3  | 502 |
| 1999MV-3     | 7314150121427  | 5  | 502 |
| 1999MV-4     | 7314150121434  | 5  | 502 |
| 1999MV-5     | 7314150121441  | 5  | 502 |
| 1999MV-6     | 7314150121458  | 5  | 502 |
| 1999MV-7     | 7314150121465  | 5  | 502 |
| 1999MV-8     | 7314150121472  | 5  | 502 |
| 1999MV-9     | 7314150121489  | 5  | 502 |
| 1RM-10       | 7314153000576  | 1  | 45  |
| 1RM-11       | 7314153000583  | 1  | 45  |
| 1RM-12       | 7314153000590  | 1  | 45  |
| 1RM-13       | 7314153000606  | 1  | 45  |
| 1RM-14       | 7314153000613  | 1  | 45  |
| 1RM-15       | 7314153000620  | 1  | 45  |
| 1RM-16       | 7314153000637  | 1  | 45  |
| 1RM-17       | 7314153000644  | 1  | 45  |
| 1RM-18       | 7314153000651  | 1  | 45  |
| 1RM-19       | 7314153000668  | 1  | 45  |
| 1RM-21       | 7314150214495  | 1  | 45  |
| 1RM-22       | 73141530005915 | 1  | 45  |
| 1RM-24       | 73141530005922 | 1  | 45  |
| 1RM-27       | 7314153014177  | 1  | 45  |
| 1RM-30       | 7314153014184  | 1  | 45  |
| 1RM-32       | 7314153014191  | 1  | 45  |
| 1RM-6        | 7314153014146  | 1  | 45  |





# 1RM-7



|                  |               |    |     |
|------------------|---------------|----|-----|
| 1RM-7            | 7314153014153 | 1  | 45  |
| 1RM-8            | 7314153000552 | 1  | 45  |
| 1RM-9            | 7314153000569 | 1  | 45  |
| 1RM/S5           | 7314150225514 | 10 | 46  |
| 1RM/SH12         | 7314150219780 | 10 | 46  |
| 1RM/SH6          | 7314150219773 | 1  | 46  |
| 1RM/SH8          | 7314150223015 | 1  | 46  |
| 1RMA-10-1/4-BIT  | 7314153014634 | 1  | 48  |
| 1RMA-10-1/4-SQ   | 7314153014603 | 1  | 48  |
| 1RMA-13-10-BIT   | 7314150223008 | 1  | 48  |
| 1RMA-13-3/8-SQ   | 7314153014610 | 1  | 48  |
| 1RMA-13-5/16-BIT | 7314153014641 | 1  | 48  |
| 1RMA-19-1/2-SQ   | 7314153014627 | 1  | 48  |
| 1RMA-19-1/4-SQ   | 7314150190638 | 1  | 48  |
| 1RMA/S4          | 7314153014658 | 1  | 48  |
| 1RMA/S8          | 7314153014665 | 1  | 46  |
| 1RZ-1/2          | 7314153014245 | 1  | 45  |
| 1RZ-1/4          | 7314150153725 | 1  | 45  |
| 1RZ-11/16        | 7314153014269 | 1  | 45  |
| 1RZ-11/32        | 7314150358915 | 1  | 45  |
| 1RZ-15/16        | 7314150358939 | 1  | 45  |
| 1RZ-3/4          | 7314153014276 | 1  | 45  |
| 1RZ-3/8          | 7314153014214 | 1  | 45  |
| 1RZ-5/16         | 7314153014207 | 1  | 45  |
| 1RZ-5/8          | 7314153014252 | 1  | 45  |
| 1RZ-7/16         | 7314153014221 | 1  | 45  |
| 1RZ-7/8          | 7314150358922 | 1  | 45  |
| 1RZ-9/16         | 7314153014238 | 1  | 45  |
| 1RZ/SH8          | 7314150223022 | 1  | 46  |
| 1Z-1             | 7314150375189 | 10 | 41  |
| 1Z-1/2           | 7314150375103 | 10 | 41  |
| 1Z-11/16         | 7314150375134 | 10 | 41  |
| 1Z-11/32         | 7314150375073 | 10 | 41  |
| 1Z-13/16         | 7314150375158 | 10 | 41  |
| 1Z-15/16         | 7314150375172 | 5  | 41  |
| 1Z-3/16          | 7314150375028 | 20 | 41  |
| 1Z-3/4           | 7314150375141 | 10 | 41  |
| 1Z-3/8           | 7314150375080 | 10 | 41  |
| 1Z-5/16          | 7314150375066 | 10 | 41  |
| 1Z-5/8           | 7314150375127 | 10 | 41  |
| 1Z-7/16          | 7314150375097 | 10 | 41  |
| 1Z-7/32          | 7314150375035 | 20 | 41  |
| 1Z-7/8           | 7314150375165 | 10 | 41  |
| 1Z-9/16          | 7314150375110 | 10 | 41  |
| 1Z-9/32          | 7314150375059 | 20 | 41  |
| 2-21-51          | 7315962500011 | 5  | 633 |
| 2-300-14-0-0     | 7311518044138 | 10 | 31  |
| 2-300-14-2-0     | 7311518044145 | 10 | 31  |
| 2-300-14-4-0     | 7311518108786 | 10 | 31  |
| 2-300-14-D-1P    | 7311518189105 | 10 | 34  |
| 2-300-16-0-0     | 7311518020491 | 10 | 31  |
| 2-300-16-1-0     | 7311518020507 | 10 | 31  |
| 2-300-16-2-0     | 7311518020514 | 10 | 31  |
| 2-300-16-4-0     | 7311518020521 | 10 | 31  |
| 2-300-16-D-1P    | 7311518189129 | 10 | 34  |
| 2-300-18-0-0     | 7311518190545 | 10 | 31  |
| 2-300-18-2-0     | 7311518190552 | 10 | 31  |
| 2-301-14-0-0     | 7311518190569 | 10 | 31  |
| 2-301-14-2-0     | 7311518108748 | 10 | 31  |
| 2-301-14-D-1P    | 7311518189136 | 1  | 34  |
| 2-301-16-0-0     | 7311518108755 | 10 | 31  |
| 2-301-16-1-0     | 7311518020538 | 10 | 31  |
| 2-301-16-2-0     | 7311518020545 | 10 | 31  |
| 2-302-14-0-0     | 7311518044152 | 10 | 32  |
| 2-302-14-2-0     | 7311518044169 | 10 | 32  |
| 2-302-14-4-0     | 7311518108793 | 10 | 32  |
| 2-302-14-D-1P    | 7311518189150 | 10 | 34  |
| 2-302-16-0-0     | 7311518108762 | 10 | 32  |
| 2-302-16-1-0     | 7311518020552 | 10 | 32  |
| 2-302-16-2-0     | 7311518020569 | 10 | 32  |
| 2-302-16-4-0     | 7311518108809 | 10 | 32  |
| 2-302-16-D-1P    | 7311518189167 | 10 | 34  |
| 2-302-18-0-0     | 7311518190613 | 10 | 32  |
| 2-302-18-2-0     | 7311518190620 | 10 | 32  |
| 2-303-14-2-0     | 7311518044176 | 10 | 32  |
| 2-303-14-D-1P    | 7311518189174 | 10 | 34  |
| 2-303-16-0-0     | 7311518108779 | 10 | 32  |
| 2-303-16-1-0     | 7311518020576 | 10 | 32  |
| 2-303-16-2-0     | 7311518020583 | 10 | 32  |
| 2-303-16-4-0     | 7311518108830 | 10 | 32  |
| 2-303-16-D-1P    | 7311518189198 | 1  | 34  |
| 2-303-18-0-0     | 7311518190644 | 10 | 32  |
| 2-303-18-2-0     | 7311518190668 | 10 | 32  |
| 2-304-14-0-0     | 7311518044183 | 10 | 32  |
| 2-304-14-2-0     | 7311518044190 | 10 | 32  |
| 2-304-14-4-0     | 7311518108878 | 10 | 32  |
| 2-304-14-D-1P    | 7311518189204 | 10 | 34  |
| 2-304-16-0-0     | 7311518020590 | 10 | 32  |
| 2-304-16-1-0     | 7311518020606 | 10 | 32  |
| 2-304-16-2-0     | 7311518020613 | 10 | 32  |
| 2-304-16-4-0     | 7311518020620 | 10 | 32  |
| 2-304-16-D-1P    | 7311518189211 | 10 | 34  |
| 2-304-18-0-0     | 7311518190712 | 10 | 32  |
| 2-304-18-2-0     | 7311518190736 | 10 | 32  |
| 2-305-16-1-0     | 7311518020637 | 10 | 32  |
| 2-305-16-2-0     | 7311518108908 | 10 | 32  |



|               |               |    |     |
|---------------|---------------|----|-----|
| 2-306-14-D-1P | 7311518189228 | 1  | 35  |
| 2-306-16-1-0  | 7311518020644 | 10 | 32  |
| 2-306-16-2-0  | 7311518108854 | 10 | 32  |
| 2-307-14-0-0  | 7311518044206 | 10 | 32  |
| 2-307-14-2-0  | 7311518044213 | 10 | 32  |
| 2-307-14-4-0  | 7311518108885 | 10 | 32  |
| 2-307-14-D-1P | 7311518189235 | 10 | 35  |
| 2-307-16-0-0  | 7311518020651 | 10 | 32  |
| 2-307-16-1-0  | 7311518020668 | 10 | 32  |
| 2-307-16-2-0  | 7311518020675 | 10 | 32  |
| 2-307-16-4-0  | 7311518020682 | 10 | 32  |
| 2-307-16-D-1P | 7311518189242 | 10 | 35  |
| 2-307-18-0-0  | 7311518190965 | 10 | 32  |
| 2-307-18-2-0  | 7311518190972 | 10 | 32  |
| 2-308-14-2-0  | 7311518044220 | 10 | 32  |
| 2-308-14-D-1P | 7311518189259 | 1  | 35  |
| 2-308-16-0-0  | 7311518108861 | 10 | 32  |
| 2-308-16-1-0  | 7311518020699 | 10 | 32  |
| 2-308-16-2-0  | 7311518020705 | 10 | 32  |
| 2-309-16-2-0  | 7311518108946 | 10 | 32  |
| 2-309-16-4-0  | 7311518191054 | 10 | 32  |
| 2-313-16-0-0  | 7311518191177 | 10 | 32  |
| 2-470-14-0-0  | 7311518191191 | 10 | 33  |
| 2-470-14-2-0  | 7311518109080 | 10 | 33  |
| 2-470-14-4-0  | 7311518191207 | 10 | 33  |
| 2-470-16-1-0  | 7311518010942 | 10 | 33  |
| 2-470-16-2-0  | 7311518109097 | 10 | 33  |
| 2-471-16-1-0  | 7311518010959 | 5  | 33  |
| 2-472-14-0-0  | 7311518191214 | 5  | 34  |
| 2-472-14-2-0  | 7311518109103 | 5  | 34  |
| 2-472-16-0-0  | 7311518191238 | 5  | 34  |
| 2-472-16-1-0  | 7311518010966 | 5  | 34  |
| 2-472-16-2-0  | 7311518108922 | 5  | 34  |
| 2010          | 7314151584610 | 1  | 442 |
| 202A          | 7314150476220 | 5  | 652 |
| 204030150     | 8413345400855 | 12 | 550 |
| 204030160     | 8413345400862 | 12 | 550 |
| 204030180     | 8413345400879 | 12 | 550 |
| 204050130     | 8413345097970 | 6  | 550 |
| 204530140     | 8413345097918 | 12 | 551 |
| 204550130     | 8413345097956 | 6  | 551 |
| 2045A3000     | 8413345097932 | 12 | 551 |
| 2047-0-8-4    | 7314151060459 | 5  | 229 |
| 2047-1-5-5    | 7314151060473 | 5  | 229 |
| 2047-1-2-8    | 7314151060480 | 5  | 229 |
| 2047-1-6-10   | 7314151060497 | 1  | 229 |
| 2047-2-12     | 7314151060503 | 1  | 229 |
| 2047PR-1-2    | 7314151060558 | 5  | 229 |
| 2047PR-3-4    | 7314151060565 | 5  | 229 |
| 2047PZ-1-2    | 7314150216390 | 5  | 229 |
| 204B          | 7314150476244 | 5  | 653 |
| 2058-BR       | 7314151849290 | 1  | 84  |
| 2058/S26      | 7314151849276 | 1  | 168 |
| 2058/S26-2    | 7314151849283 | 1  | 168 |
| 2058/S26AF    | 7314150516308 | 1  | 168 |
| 208           | 7311518017545 | 5  | 556 |
| 209027040     | 8413345400947 | 12 | 550 |
| 209227060     | 8413345400961 | 12 | 551 |
| 209228100     | 8413345099233 | 12 | 551 |
| 209250100     | 8413345099585 | 6  | 551 |
| 210           | 7315965100379 | 10 | 556 |
| 2100PD-150    | 7314150205691 | 5  | 234 |
| 2101D-125     | 7314150106387 | 5  | 232 |
| 2101D-125IP   | 7314150106431 | 5  | 232 |
| 2101D-140     | 7314150106394 | 5  | 232 |
| 2101D-140IP   | 7314150106325 | 5  | 232 |
| 2101D-160     | 7314150106400 | 5  | 232 |
| 2101D-160IP   | 7314150106318 | 5  | 232 |
| 2101D-180     | 7314150106417 | 5  | 232 |
| 2101D-180IP   | 7314150106448 | 5  | 232 |
| 2101G-125     | 7314150106462 | 5  | 232 |
| 2101G-125IP   | 7314150106516 | 5  | 232 |
| 2101G-125IPD  | 7314150335039 | 5  | 232 |
| 2101G-140     | 7314150106479 | 5  | 232 |
| 2101G-140IP   | 7314150106288 | 5  | 232 |
| 2101G-140IPD  | 7314150335053 | 5  | 232 |
| 2101G-160     | 7314150106486 | 5  | 232 |
| 2101G-160IP   | 7314150106295 | 5  | 232 |
| 2101G-160IPD  | 7314150335060 | 5  | 232 |
| 2101G-180     | 7314150106493 | 5  | 232 |
| 2101G-180IP   | 7314150106523 | 5  | 232 |
| 2101G-180IPD  | 7314150335077 | 5  | 232 |
| 2101GC-125IP  | 7314150106547 | 5  | 232 |
| 2101GC-140IP  | 7314150106554 | 5  | 232 |
| 2101GC-160IP  | 7314150106561 | 5  | 232 |
| 2101GC-180IP  | 7314150106578 | 5  | 232 |
| 2101PG-160    | 7314150113972 | 5  | 232 |
| 2101S-140     | 7314150106592 | 3  | 498 |
| 2101S-160     | 7314150106608 | 3  | 498 |
| 2101S-180     | 7314150106615 | 3  | 498 |
| 2101S-200     | 7314150106622 | 3  | 499 |
| 211035180     | 8413345000147 | 5  | 551 |
| 211042210     | 8413345000154 | 5  | 551 |
| 212027180     | 8413345000178 | 5  | 551 |
| 212033220     | 8413345129435 | 8  | 551 |
| 212202500     | 8413345110266 | 10 | 552 |



|             |               |     |     |
|-------------|---------------|-----|-----|
| 212302900   | 8413345110280 | 10  | 552 |
| 212502150   | 8413345110303 | 10  | 552 |
| 212602150   | 8413345110327 | 10  | 552 |
| 212602800   | 8413345129404 | 1   | 552 |
| 212704350   | 8413345122184 | 6   | 551 |
| 212A        | 7314150420827 | 10  | 653 |
| 213026140   | 8413345000185 | 5   | 551 |
| 2145020D0   | 8413345097994 | 1   | 551 |
| 2145020L0   | 8413345098045 | 1   | 551 |
| 2145025C0   | 8413345098083 | 1   | 552 |
| 2145025D0   | 8413345098007 | 1   | 551 |
| 2145025L0   | 8413345098052 | 1   | 551 |
| 2145030D0   | 8413345098014 | 1   | 551 |
| 2145030L0   | 8413345098069 | 1   | 551 |
| 2145035D0   | 8413345098021 | 1   | 551 |
| 2145035L0   | 8413345098076 | 1   | 551 |
| 2145039C0   | 8413345098090 | 1   | 552 |
| 2145PD-150  | 7314150114009 | 5   | 236 |
| 215-150     | 7311518017576 | 1   | 558 |
| 215000030   | 8413345131971 | 12  | 549 |
| 215000040   | 8413345131988 | 12  | 549 |
| 215000050   | 8413345131995 | 12  | 549 |
| 215000060   | 8412243557944 | 12  | 549 |
| 215000070   | 8413345132008 | 12  | 549 |
| 215000080   | 8413345132015 | 12  | 549 |
| 215000090   | 8413345132022 | 12  | 549 |
| 215000100   | 8413345132039 | 12  | 549 |
| 215000120   | 8413345132046 | 12  | 549 |
| 215500300   | 7314150220120 | 12  | 549 |
| 215500400   | 8413345122627 | 12  | 549 |
| 215500500   | 8413345122641 | 12  | 549 |
| 215500600   | 8413345122665 | 12  | 549 |
| 215500700   | 8413345122689 | 12  | 549 |
| 215500800   | 8413345122702 | 12  | 549 |
| 215500900   | 8413345137478 | 12  | 549 |
| 215501000   | 8413345122726 | 12  | 549 |
| 216-150-R   | 7311518017583 | 1   | 558 |
| 216-300-R   | 7311518017798 | 1   | 558 |
| 216000300   | 8413345403658 | 12  | 549 |
| 216000400   | 8413345403665 | 12  | 549 |
| 216000500   | 8413345403672 | 12  | 549 |
| 216000600   | 8413345403689 | 12  | 549 |
| 216000700   | 8413345403696 | 12  | 549 |
| 216000800   | 8413345403702 | 12  | 549 |
| 216000900   | 8413345403719 | 12  | 549 |
| 216001000   | 8413345403726 | 12  | 549 |
| 216001200   | 8413345403740 | 12  | 549 |
| 216100040   | 8413345132053 | 12  | 549 |
| 216100060   | 8413345132091 | 12  | 549 |
| 216100080   | 8413345132060 | 12  | 549 |
| 216100100   | 8413345132077 | 12  | 549 |
| 216100120   | 8413345132084 | 12  | 549 |
| 216500300   | 8413345407274 | 12  | 549 |
| 216500500   | 8413345407281 | 12  | 549 |
| 216500750   | 8413345407298 | 12  | 549 |
| 216501000   | 8413345407304 | 12  | 549 |
| 2171G-140   | 7314150116232 | 5   | 234 |
| 2171G-160   | 7314150116133 | 5   | 234 |
| 2171G-180   | 7314150116140 | 5   | 234 |
| 2171V-160   | 7314150126798 | 2   | 499 |
| 2171V-180   | 7314150126804 | 2   | 499 |
| 2171V-200   | 7314150466009 | 2   | 499 |
| 218         | 7311518017521 | 10  | 557 |
| 218-BULK    | 7311518140946 | 150 | 557 |
| 219         | 7311518140953 | 120 | 557 |
| 219001000   | 8413345029865 | 5   | 549 |
| 219001200   | 8413345029872 | 5   | 549 |
| 219001400   | 8413345029889 | 5   | 549 |
| 219001600   | 8413345029896 | 5   | 549 |
| 219002000   | 8413345029902 | 5   | 549 |
| 2190PD-150  | 7314150114016 | 5   | 237 |
| 219201000   | 8413345029667 | 5   | 549 |
| 219201200   | 8413345029674 | 5   | 549 |
| 219201400   | 8413345029681 | 5   | 549 |
| 219201600   | 8413345029698 | 5   | 549 |
| 219202000   | 8413345029704 | 5   | 549 |
| 219302500   | 8413345129466 | 10  | 549 |
| 219303000   | 8413345129473 | 10  | 549 |
| 219303500   | 8413345129480 | 10  | 549 |
| 21HDD-140   | 7314150231256 | 5   | 233 |
| 21HDD-140IP | 7314150231263 | 5   | 233 |
| 21HDD-160   | 7314150231270 | 5   | 233 |
| 21HDD-160IP | 7314150231287 | 5   | 233 |
| 21HDD-180   | 7314150231294 | 5   | 233 |
| 21HDD-180IP | 7314150231300 | 5   | 233 |
| 21HDD-200   | 7314150231317 | 5   | 233 |
| 21HDD-200IP | 7314150231324 | 5   | 233 |
| 21HDG-140   | 7314150231331 | 5   | 232 |
| 21HDG-140A  | 7314150237654 | 5   | 233 |
| 21HDG-140IP | 7314150231348 | 5   | 232 |
| 21HDG-160   | 7314150231355 | 5   | 232 |
| 21HDG-160A  | 7314150237661 | 5   | 233 |
| 21HDG-160IP | 7314150231362 | 5   | 232 |
| 21HDG-180   | 7314150231379 | 5   | 232 |
| 21HDG-180A  | 7314150237678 | 5   | 233 |
| 21HDG-180IP | 7314150231386 | 5   | 232 |



|              |               |     |     |
|--------------|---------------|-----|-----|
| 21HDG-200    | 7314150231409 | 5   | 232 |
| 21HDG-200A   | 7314150238439 | 5   | 233 |
| 21HDG-200IP  | 7314150231416 | 5   | 232 |
| 21HDGC-140IP | 7314150231423 | 5   | 233 |
| 21HDGC-160IP | 7314150231430 | 5   | 233 |
| 21HDGC-180IP | 7314150231447 | 5   | 233 |
| 21HDGC-200IP | 7314150231454 | 5   | 233 |
| 221 D        | 7314150037070 | 5   | 248 |
| 221201200    | 8413345029711 | 5   | 550 |
| 221202000    | 8413345029728 | 5   | 550 |
| 221203000    | 8413345029735 | 5   | 550 |
| 221301200    | 8413345029742 | 5   | 550 |
| 221302000    | 8413345029759 | 5   | 550 |
| 221303000    | 8413345029766 | 5   | 550 |
| 222 D        | 7314150037087 | 5   | 248 |
| 22209004B    | 8413345401333 | 1   | 348 |
| 2223 D-150   | 7314150033591 | 5   | 252 |
| 2223 G-150   | 7314150113651 | 5   | 251 |
| 2223 S-150   | 7314150032983 | 3   | 500 |
| 2223V-160    | 7314150134113 | 2   | 501 |
| 223 D        | 7314150037094 | 5   | 248 |
| 2233 D-160   | 7314150114023 | 5   | 238 |
| 2233 D-200   | 7314150114030 | 5   | 238 |
| 2233 D-240   | 7314150114047 | 5   | 238 |
| 2233D-160IP  | 7314150114054 | 5   | 238 |
| 2233D-200IP  | 7314150114061 | 5   | 238 |
| 2233D-240IP  | 7314150114078 | 5   | 238 |
| 2235-160     | 7314150179695 | 1   | 238 |
| 224 D        | 7314150037100 | 5   | 248 |
| 225 D        | 7314150037117 | 5   | 248 |
| 225-PLUS     | 7311518029708 | 5   | 556 |
| 2250V-170    | 7314150128730 | 2   | 499 |
| 2250V-230    | 7314150128747 | 2   | 499 |
| 227-22       | 7314150419845 | 1   | 120 |
| 227-24       | 7314150419852 | 1   | 120 |
| 227-27       | 7314150419869 | 1   | 120 |
| 227-30       | 7314150419876 | 1   | 120 |
| 227-32       | 7314150419883 | 1   | 120 |
| 227-34       | 7314150419890 | 1   | 120 |
| 227-36       | 7314150419906 | 1   | 120 |
| 227-41       | 7314150419913 | 1   | 120 |
| 227-46       | 7314150419920 | 1   | 120 |
| 228          | 7311518014995 | 80  | 557 |
| 228-15-5P    | 7311518031442 | 10  | 558 |
| 228-22       | 7314150420070 | 1   | 121 |
| 228-24       | 7314150420087 | 1   | 121 |
| 228-27       | 7314150420094 | 1   | 121 |
| 228-30       | 7314150420100 | 1   | 121 |
| 228-32       | 7314150420117 | 1   | 121 |
| 228-32-100P  | 7311518150990 | 1   | 558 |
| 228-32-10P   | 7311518010867 | 10  | 558 |
| 228-32-5P    | 7311518031459 | 10  | 558 |
| 228-34       | 7314150420124 | 1   | 121 |
| 228-36       | 7314150420131 | 1   | 121 |
| 228-41       | 7314150420148 | 1   | 121 |
| 228-46       | 7314150420155 | 1   | 121 |
| 228-BULK     | 7311518009069 | 5   | 557 |
| 228-SD       | 7311518277048 | 24  | 153 |
| 228-SET-SD   | 7314150217946 | 1   | 154 |
| 229-SD       | 7311518277055 | 24  | 154 |
| 22F-3/4      | 7314150419821 | 1   | 119 |
| 22R-3/4      | 7314150419838 | 1   | 119 |
| 23-15        | 7311518274665 | 10  | 634 |
| 23-21        | 7311518012274 | 10  | 634 |
| 23-24        | 7311518003852 | 10  | 634 |
| 23-30        | 7311518003869 | 10  | 634 |
| 23-32        | 7311518003876 | 10  | 634 |
| 23-36        | 7311518003883 | 10  | 634 |
| 230-SD       | 7311518280956 | 25  | 154 |
| 2303B0000    | 8413345091404 | 6   | 550 |
| 2303D0000    | 8413345091428 | 6   | 550 |
| 2304C0000    | 8413345091565 | 6   | 550 |
| 2308A0000    | 8413345091602 | 6   | 550 |
| 2308B0000    | 8413345091626 | 6   | 550 |
| 232-SD       | 7314150214839 | 1   | 154 |
| 233-300      | 7311518044015 | 5   | 565 |
| 233-300-A    | 7311518044039 | 5   | 565 |
| 233-400      | 7311518044022 | 5   | 565 |
| 2339 D       | 7314150032792 | 3   | 236 |
| 2339 DIP     | 7314150103508 | 5   | 236 |
| 2339-220     | 7314150442461 | 5   | 237 |
| 2339-220IP   | 7314150101061 | 5   | 237 |
| 2339-250IP   | 7314150101078 | 5   | 237 |
| 2339-280IP   | 7314150101948 | 5   | 237 |
| 2339-300IP   | 7314150123865 | 6   | 237 |
| 2339D-300    | 7314150411245 | 5   | 236 |
| 2339D-300IP  | 7314150411238 | 6   | 236 |
| 234-A1       | 7311518013653 | 1   | 565 |
| 234-A2       | 7311518013660 | 1   | 565 |
| 234-SD       | 7314150214846 | 25  | 154 |
| 234-W1       | 7311518013608 | 10  | 565 |
| 234-W2       | 7311518013615 | 10  | 565 |
| 234-W3       | 7311518013622 | 10  | 565 |
| 238          | 7311518011314 | 60  | 557 |
| 239          | 7311518010874 | 150 | 557 |
| 2420 G-125   | 7314150102525 | 5   | 244 |



# 2420G-125IP



|                |               |    |     |
|----------------|---------------|----|-----|
| 2420G-125IP    | 7314150447091 | 5  | 244 |
| 2421 D-140IP   | 7314150101979 | 5  | 245 |
| 2421 D-160IP   | 7314150101986 | 5  | 245 |
| 2421 D-180IP   | 7314150101993 | 5  | 245 |
| 2421 G-140     | 7314150102532 | 5  | 244 |
| 2421 G-140IP   | 7314150102006 | 5  | 244 |
| 2421 G-160     | 7314150102549 | 5  | 244 |
| 2421 G-160 IP  | 7314150100576 | 5  | 244 |
| 2421 G-180     | 7314150102556 | 5  | 244 |
| 2421 G-180 IP  | 7314150100583 | 5  | 244 |
| 2421GC-140IP   | 7314150447107 | 5  | 244 |
| 2421GC-160IP   | 7314150447114 | 5  | 244 |
| 2421GC-180IP   | 7314150233229 | 5  | 244 |
| 2421S-140      | 7314150447121 | 3  | 500 |
| 2421S-160      | 7314150447138 | 3  | 500 |
| 2421S-180      | 7314150447145 | 3  | 500 |
| 2421V-160      | 7314150126774 | 2  | 500 |
| 2427 D-160     | 7314150032846 | 5  | 243 |
| 2427 D-200     | 7314150169030 | 5  | 243 |
| 2427 G-160     | 7314150100408 | 5  | 243 |
| 2427 G-160 IP  | 7314150100743 | 5  | 243 |
| 2427 G-200     | 7314150100415 | 5  | 243 |
| 2427 G-200 IP  | 7314150100750 | 5  | 243 |
| 2427 GC-160IP  | 7314150102051 | 5  | 243 |
| 2427 GC-200IP  | 7314150102075 | 5  | 243 |
| 2427 S-200     | 7314150033027 | 3  | 500 |
| 2427S-160      | 7314150447008 | 3  | 500 |
| 2427V-200      | 7314150126903 | 2  | 500 |
| 2430 D-140     | 7314150032853 | 5  | 241 |
| 2430 D-140 IP  | 7314150100774 | 5  | 241 |
| 2430 D-160     | 7314150032860 | 5  | 241 |
| 2430 D-160 IP  | 7314150100781 | 5  | 241 |
| 2430 D-200     | 7314150032884 | 5  | 241 |
| 2430 D-200 IP  | 7314150100804 | 5  | 241 |
| 2430 G-140     | 7314150102563 | 5  | 241 |
| 2430 G-140 IP  | 7314150102143 | 5  | 241 |
| 2430 G-160     | 7314150024070 | 5  | 241 |
| 2430 G-160 IP  | 7314150100811 | 5  | 241 |
| 2430 G-200     | 7314150100422 | 5  | 241 |
| 2430 G-200 IP  | 7314150100835 | 5  | 241 |
| 2430 GC-140 IP | 7314150102150 | 5  | 241 |
| 2430 GC-160 IP | 7314150102167 | 5  | 241 |
| 2430 GC-200 IP | 7314150102174 | 5  | 241 |
| 2430 S-160     | 7314150206742 | 3  | 500 |
| 2430 S-200     | 7314150033010 | 3  | 500 |
| 2430S-140      | 7314150446995 | 3  | 500 |
| 2430V-160      | 7314150126880 | 2  | 500 |
| 2430V-200      | 7314150126897 | 2  | 500 |
| 2431G-125      | 7314150447015 | 5  | 241 |
| 2431G-125IP    | 7314150447053 | 5  | 241 |
| 2431G-140      | 7314150447022 | 5  | 241 |
| 2431G-140IP    | 7314150447060 | 5  | 241 |
| 2431G-160      | 7314150447039 | 5  | 241 |
| 2431G-160IP    | 7314150447077 | 5  | 241 |
| 2431G-180      | 7314150447046 | 5  | 241 |
| 2431G-180IP    | 7314150447084 | 5  | 241 |
| 244-20-U7/8-HP | 7311518012519 | 10 | 563 |
| 244-22-U7/8-HP | 7311518012526 | 10 | 563 |
| 2446           | 7314150128648 | 15 | 583 |
| 2446-BL        | 7314150508242 | 15 | 583 |
| 2446-EL        | 7314150270736 | 12 | 584 |
| 2446-EL-HELP   | 7314150394500 | 12 | 584 |
| 2446-ELL       | 7314150370153 | 12 | 584 |
| 2446-ELR       | 7314150370146 | 12 | 584 |
| 2446-LAP       | 7314150508228 | 15 | 583 |
| 2446-LINO      | 7314150270750 | 12 | 583 |
| 2446-OV        | 7314150313662 | 15 | 584 |
| 2446-SAFE      | 7314150453078 | 15 | 583 |
| 2448           | 7314150136049 | 12 | 572 |
| 2449           | 7314150194056 | 12 | 572 |
| 244P-20-U7-HP  | 7311518235499 | 4  | 565 |
| 244P-22-U7-HP  | 7311518235482 | 10 | 565 |
| 2460           | 7314151063467 | 1  | 251 |
| 2461 C19       | 7314151063498 | 1  | 249 |
| 2461 C40       | 7314151063504 | 1  | 249 |
| 2461 C8        | 7314151063481 | 1  | 249 |
| 2463 D19       | 7314151063511 | 1  | 249 |
| 2463 D40       | 7314151063528 | 1  | 249 |
| 2463 D8        | 7314151588878 | 1  | 249 |
| 2464 A10       | 7314151063535 | 1  | 250 |
| 2464 A19       | 7314151063542 | 1  | 250 |
| 2464 A3        | 7314151406516 | 1  | 250 |
| 2464 A40       | 7314151063559 | 1  | 250 |
| 2465D-200      | 7314150120826 | 1  | 251 |
| 2466 B10       | 7314151063573 | 1  | 250 |
| 2466 B19       | 7314151063580 | 1  | 250 |
| 2466 B3        | 7314151406868 | 1  | 250 |
| 2466 B40       | 7314151063597 | 1  | 250 |
| 247-24         | 7314150367078 | 1  | 117 |
| 247-27         | 7314150367085 | 1  | 117 |
| 247-30         | 7314150367092 | 1  | 117 |
| 247-32         | 7314150367108 | 1  | 117 |
| 247-34         | 7314150367115 | 1  | 117 |
| 247-36         | 7314150367122 | 1  | 117 |
| 247-41         | 7314150367139 | 1  | 117 |
| 247-46         | 7314150367146 | 1  | 117 |



|                 |               |    |     |
|-----------------|---------------|----|-----|
| 247-50          | 7314150367153 | 1  | 117 |
| 247-55          | 7314150367160 | 1  | 117 |
| 247-60          | 7314150367177 | 1  | 117 |
| 2470 G-160      | 7314150116188 | 5  | 242 |
| 2470 G-200      | 7314150116195 | 5  | 242 |
| 2471 G-160      | 7314150116225 | 5  | 245 |
| 2477 G-200      | 7314150116201 | 5  | 244 |
| 2477G-160       | 7314150134977 | 5  | 244 |
| 248-24          | 7314150367818 | 1  | 118 |
| 248-27          | 7314150367825 | 1  | 118 |
| 248-30          | 7314150367832 | 1  | 118 |
| 248-32          | 7314150367849 | 1  | 118 |
| 248-34          | 7314150367856 | 1  | 118 |
| 248-36          | 7314150367863 | 1  | 118 |
| 248-41          | 7314150367870 | 1  | 118 |
| 248-46          | 7314150367887 | 1  | 118 |
| 248-50          | 7314150367894 | 1  | 118 |
| 248-55          | 7314150367900 | 1  | 118 |
| 248-60          | 7314150367917 | 1  | 118 |
| 2484-20         | 7314150233250 | 1  | 370 |
| 2484-30         | 7314150233267 | 1  | 370 |
| 2484-45         | 7314150233274 | 1  | 370 |
| 2484-60         | 7314150233281 | 1  | 370 |
| 2484/S4         | 7311518276553 | 10 | 370 |
| 2484T-20        | 7314150455102 | 1  | 370 |
| 2484T-30        | 7314150455119 | 1  | 370 |
| 2484T-45        | 7314150455126 | 1  | 370 |
| 2484T-60        | 7314150455133 | 1  | 370 |
| 2484T/S4        | 7314150455096 | 1  | 370 |
| 2485            | 7314150242382 | 1  | 348 |
| 2487            | 7311518276058 | 12 | 536 |
| 2488            | 7311518276072 | 12 | 550 |
| 2489            | 7311518276065 | 12 | 550 |
| 24A-14          | 7314150368235 | 1  | 119 |
| 24A-27          | 7314150368242 | 1  | 119 |
| 24F-1           | 7314150366231 | 1  | 116 |
| 24F-3/4         | 7314150366224 | 1  | 116 |
| 24R-1           | 7314150365951 | 1  | 115 |
| 24R-3/4         | 7314150365944 | 1  | 115 |
| 24T-1           | 7314150366156 | 1  | 116 |
| 24T-3/4         | 7314150366149 | 1  | 116 |
| 24W             | 7314150368266 | 1  | 119 |
| 2500-16-XT-HP   | 7311518160159 | 4  | 563 |
| 2500-19-XT-HP   | 7311518160722 | 4  | 563 |
| 2500-22-XT-HP   | 7311518140922 | 4  | 563 |
| 2500-24-XT7-HP  | 7311518181338 | 4  | 563 |
| 250400010       | 7314150314430 | 1  | 552 |
| 250400020       | 7314150393008 | 1  | 552 |
| 250400030       | 7314150393015 | 1  | 552 |
| 250501800       | 8413345128964 | 50 | 552 |
| 250502450       | 8413345128957 | 1  | 553 |
| 2509            | 7314151064280 | 50 | 371 |
| 2520            | 7314150023752 | 1  | 238 |
| 2521 G-140      | 7314150100293 | 5  | 246 |
| 2521 G-160 IP   | 7314150100620 | 5  | 246 |
| 2521D-140IP     | 7314150447176 | 5  | 246 |
| 2521D-160IP     | 7314150447183 | 5  | 246 |
| 2521G-140IP     | 7314150447169 | 5  | 246 |
| 2521G-160       | 7314150447152 | 5  | 246 |
| 2521S-140       | 7314150447190 | 3  | 500 |
| 2521S-160       | 7314150447206 | 3  | 500 |
| 2521V-160       | 7314150126781 | 2  | 500 |
| 2530            | 7314150326761 | 1  | 371 |
| 2530-40         | 7314151317294 | 5  | 536 |
| 2535F0          | 7314150402236 | 1  | 371 |
| 2535F1          | 7314151064495 | 1  | 371 |
| 2535F2          | 7314150233854 | 1  | 371 |
| 2535F3          | 7314150180233 | 1  | 371 |
| 2535L           | 7314150125357 | 12 | 371 |
| 255-17/34       | 7314150272372 | 2  | 561 |
| 255-34          | 7314150272365 | 2  | 561 |
| 2555            | 7311518276041 | 1  | 308 |
| 256-26          | 7311518000080 | 4  | 561 |
| 2600-16-XT11-HP | 7311518239527 | 4  | 562 |
| 2600-19-XT-HP   | 7311518160760 | 4  | 563 |
| 2600-22-XT-HP   | 7311518160777 | 4  | 563 |
| 2620-80         | 7311518200947 | 1  | 238 |
| 2628 D-160      | 7314150123193 | 5  | 240 |
| 2628 D-180      | 7314150042661 | 5  | 240 |
| 2628 D-200      | 7314150123315 | 5  | 240 |
| 2628 G-160      | 7314150042999 | 5  | 239 |
| 2628 G-160IP    | 7314150055357 | 5  | 239 |
| 2628 G-180      | 7314150042678 | 5  | 239 |
| 2628 G-180IP    | 7314150044030 | 5  | 239 |
| 2628 G-200      | 7314150103539 | 5  | 239 |
| 2628 GC-160IP   | 7314150101863 | 5  | 239 |
| 2628 GC-180IP   | 7314150101870 | 5  | 239 |
| 2628 GC-200IP   | 7314150101887 | 5  | 239 |
| 2628 S-160      | 7314150206735 | 3  | 499 |
| 2628 S-180      | 7314150044054 | 3  | 499 |
| 2628 S-200      | 7314150043002 | 3  | 499 |
| 2628G-200IP     | 7314150101085 | 5  | 239 |
| 2629G-160       | 7314150446933 | 5  | 240 |
| 2629G-160IP     | 7314150446964 | 5  | 240 |
| 2629G-180       | 7314150446940 | 5  | 240 |
| 2629G-180IP     | 7314150446971 | 5  | 240 |



|                |               |    |     |
|----------------|---------------|----|-----|
| 2629G-200      | 7314150446957 | 5  | 240 |
| 2629G-200IP    | 7314150446988 | 5  | 240 |
| 2630DC-160IP   | 7314150446896 | 5  | 240 |
| 2630DC-180IP   | 7314150446902 | 5  | 240 |
| 2630DC-200IP   | 7314150446919 | 5  | 240 |
| 2630GC-160IP   | 7314150180165 | 5  | 240 |
| 2630GC-180IP   | 7314150180172 | 5  | 240 |
| 2630GC-200IP   | 7314150180189 | 5  | 240 |
| 2630SC-180     | 7314150446926 | 3  | 499 |
| 2632           | 7314151065706 | 1  | 370 |
| 2633/S4        | 7311518276942 | 12 | 535 |
| 2633HD/S6      | 7314150205783 | 1  | 315 |
| 2633HD1        | 7314150230464 | 1  | 315 |
| 2633HD2        | 7314150230471 | 1  | 315 |
| 2633HD3        | 7314150230488 | 1  | 315 |
| 2633HD4        | 7314150230495 | 1  | 315 |
| 2633HD5        | 7314150230501 | 1  | 315 |
| 2633HD6        | 7314150230518 | 1  | 315 |
| 2633L/S4       | 7311518276959 | 12 | 535 |
| 2635           | 7311518276348 | 1  | 609 |
| 2640D-160      | 7314150123766 | 10 | 240 |
| 2640D-180      | 7314150123773 | 5  | 240 |
| 2640D-200      | 7314150123797 | 5  | 240 |
| 2646           | 7314151304638 | 1  | 235 |
| 2646 A         | 7314151304645 | 1  | 235 |
| 2646 AK        | 7314151396619 | 1  | 235 |
| 2646 K         | 7314151495862 | 1  | 235 |
| 2646 M         | 7314151487928 | 1  | 235 |
| 2646 MF        | 7314151573683 | 1  | 245 |
| 2646 MS        | 7314151573768 | 1  | 246 |
| 2646 R         | 7314151304706 | 1  | 235 |
| 2646 RA        | 7314151834838 | 1  | 235 |
| 2646 RK        | 7314151496678 | 1  | 235 |
| 2648           | 7314151304713 | 1  | 235 |
| 2648 A         | 7314151304720 | 1  | 235 |
| 2649           | 7314150058013 | 1  | 235 |
| 2650           | 7314151065829 | 1  | 248 |
| 2650 B         | 7314151065843 | 1  | 248 |
| 2656           | 7314151304737 | 1  | 237 |
| 2656 R         | 7314151473976 | 1  | 244 |
| 2656 S         | 7314150058044 | 1  | 242 |
| 2666           | 7314150058006 | 1  | 235 |
| 2666 FK        | 7314151066079 | 1  | 235 |
| 2674 NB        | 7314151066321 | 1  | 234 |
| 2674 NVDE      | 7314151498535 | 1  | 499 |
| 2676 B         | 7314151066390 | 1  | 235 |
| 2678 B         | 7314151066468 | 1  | 235 |
| 2678 G-160     | 7314150116157 | 5  | 241 |
| 2678 G-180     | 7314150116164 | 5  | 241 |
| 2678 G-200     | 7314150116171 | 5  | 241 |
| 2678V-160      | 7314150126835 | 2  | 499 |
| 2678V-180      | 7314150126842 | 2  | 499 |
| 2678V-200      | 7314150126859 | 2  | 499 |
| 268            | 7311518017538 | 5  | 557 |
| 2681           | 7311518276706 | 12 | 263 |
| 2681-1         | 7314150116980 | 1  | 264 |
| 2688D-250      | 7314150123520 | 3  | 240 |
| 2690           | 7314150411108 | 10 | 263 |
| 26S-1216       | 7314151830236 | 8  | 59  |
| 26S-16         | 7314150345588 | 5  | 59  |
| 26S-610        | 7314151830229 | 10 | 59  |
| 2700-22-XT7-HP | 7311518191672 | 4  | 565 |
| 2700-24-XT7-HP | 7311518191665 | 4  | 565 |
| 2704A          | 7314151066963 | 1  | 579 |
| 2705R          | 7314151821470 | 1  | 579 |
| 2720           | 7314150179701 | 1  | 238 |
| 2720-SH        | 7314150179718 | 1  | 238 |
| 2744           | 7314151809096 | 6  | 579 |
| 277-30         | 7314150367184 | 1  | 117 |
| 277-32         | 7314150367191 | 1  | 117 |
| 277-34         | 7314150367207 | 1  | 117 |
| 277-36         | 7314150367214 | 1  | 117 |
| 277-41         | 7314150367221 | 1  | 117 |
| 277-46         | 7314150367238 | 1  | 117 |
| 277-50         | 7314150367245 | 1  | 117 |
| 277-55         | 7314150367252 | 1  | 117 |
| 277-60         | 7314150367269 | 1  | 117 |
| 278-30         | 7314150367924 | 1  | 118 |
| 278-32         | 7314150367931 | 1  | 118 |
| 278-34         | 7314150367948 | 1  | 118 |
| 278-36         | 7314150367955 | 1  | 118 |
| 278-41         | 7314150367962 | 1  | 118 |
| 278-46         | 7314150367979 | 1  | 118 |
| 278-50         | 7314150367986 | 1  | 118 |
| 278-55         | 7314150367993 | 1  | 118 |
| 278-60         | 7314150368006 | 1  | 118 |
| 2784-2.5       | 7314150215607 | 1  | 214 |
| 2784-3.5       | 7314150215614 | 1  | 214 |
| 2784-4.5       | 7314150215621 | 1  | 214 |
| 2787 F         | 7314151474270 | 1  | 236 |
| 2787 G         | 7314150058020 | 1  | 236 |
| 27A-24         | 7314150368259 | 1  | 119 |
| 27F-1          | 7314150366248 | 1  | 116 |
| 27M-10-11      | 7314150180523 | 10 | 58  |
| 27M-12-13      | 7314150180547 | 10 | 58  |
| 27M-13-17      | 7314150180790 | 10 | 58  |

|           |               |    |     |
|-----------|---------------|----|-----|
| 27M-14-15 | 7314150180554 | 10 | 58  |
| 27M-16-17 | 7314150180561 | 10 | 58  |
| 27M-16-18 | 7314150180806 | 10 | 58  |
| 27M-18-19 | 7314150180578 | 10 | 58  |
| 27M-20-22 | 7314150180585 | 10 | 58  |
| 27M-21-23 | 7314150180592 | 5  | 58  |
| 27M-21-24 | 7314150180813 | 5  | 58  |
| 27M-24-26 | 7314150180608 | 5  | 58  |
| 27M-24-27 | 7314150180820 | 5  | 58  |
| 27M-25-28 | 7314150180622 | 5  | 58  |
| 27M-27-29 | 7314150180639 | 5  | 58  |
| 27M-30-32 | 7314150180646 | 5  | 58  |
| 27M-6-7   | 7314150180509 | 10 | 58  |
| 27M-8-9   | 7314150180516 | 10 | 58  |
| 27M/10    | 7314150180677 | 1  | 59  |
| 27M/12    | 7314150180684 | 1  | 59  |
| 27M/12T   | 7314150180783 | 1  | 58  |
| 27M/6     | 7314150180653 | 1  | 58  |
| 27M/8     | 7314150180660 | 1  | 59  |
| 27M/8T    | 7314150180776 | 1  | 58  |
| 27R-1     | 7314150365968 | 1  | 115 |
| 27T-1     | 7314150366163 | 1  | 116 |
| 28-29/S4  | 7314150179688 | 1  | 251 |
| 2800 N    | 7314151318338 | 1  | 239 |
| 2800-140  | 7314150121632 | 3  | 249 |
| 2800-150  | 7314150034567 | 3  | 249 |
| 2800-180  | 7314150034581 | 3  | 249 |
| 2800-225  | 7314150034604 | 3  | 249 |
| 2800-300  | 7314150122622 | 1  | 249 |
| 2801 N    | 7314151318352 | 1  | 239 |
| 2804      | 7314151692698 | 1  | 238 |
| 2805-280  | 7314151826123 | 1  | 238 |
| 2820EF1   | 7314150122042 | 12 | 585 |
| 2820EF2   | 7314150122059 | 8  | 586 |
| 2820EF3   | 7314150122066 | 1  | 586 |
| 2820EF4   | 7314150122073 | 1  | 586 |
| 2820EK    | 7314150122035 | 6  | 585 |
| 2820EK-01 | 7314150270743 | 12 | 585 |
| 2820VBC   | 7314150121917 | 1  | 499 |
| 2820VDE   | 7314151605476 | 10 | 503 |
| 2820VFP   | 7314150121922 | 1  | 503 |
| 2820VG05  | 7314150121953 | 1  | 503 |
| 2820VG10  | 7314150121960 | 1  | 503 |
| 2820VGCOT | 7314150121977 | 1  | 503 |
| 2820VHELP | 7314150121908 | 1  | 503 |
| 2820VM    | 7314150121946 | 1  | 503 |
| 2820VVP   | 7314150121885 | 2  | 502 |
| 2820VPC   | 7314150121892 | 2  | 503 |
| 2820VTEE  | 7314150121939 | 1  | 503 |
| 2855      | 7314151825805 | 1  | 264 |
| 2855 D    | 7314151822569 | 1  | 264 |
| 2856-10   | 7314150437214 | 1  | 264 |
| 2856-8    | 7314150437207 | 1  | 264 |
| 2890-125  | 7314150122639 | 3  | 249 |
| 2890-140  | 7314150034550 | 3  | 249 |
| 2890-180  | 7314150034574 | 3  | 249 |
| 2890-210  | 7314150034598 | 3  | 249 |
| 2890-300  | 7314150122646 | 1  | 249 |
| 28M-10    | 7314151834678 | 5  | 56  |
| 28M-11    | 7314151834685 | 5  | 56  |
| 28M-12    | 7314151834692 | 5  | 56  |
| 28M-13    | 7314151834708 | 5  | 56  |
| 28M-14    | 7314151834715 | 5  | 56  |
| 28M-15    | 7314151834722 | 5  | 56  |
| 28M-16    | 7314151834739 | 5  | 56  |
| 28M-17    | 7314151834746 | 5  | 56  |
| 28M-18    | 7314151834753 | 3  | 56  |
| 28M-19    | 7314151834760 | 3  | 56  |
| 28M-20    | 7314150122561 | 3  | 56  |
| 28M-21    | 7314151834777 | 3  | 56  |
| 28M-22    | 7314151834784 | 3  | 56  |
| 28M-23    | 7314150122578 | 3  | 56  |
| 28M-24    | 7314151834791 | 3  | 56  |
| 28M-25    | 7314150122585 | 3  | 56  |
| 28M-26    | 7314150122592 | 3  | 56  |
| 28M-27    | 7314151834807 | 3  | 56  |
| 28M-28    | 7314150122608 | 1  | 56  |
| 28M-29    | 7314150122615 | 1  | 56  |
| 28M-30    | 7314151834814 | 1  | 56  |
| 28M-32    | 7314151834821 | 1  | 56  |
| 28M-6     | 7314151834630 | 5  | 56  |
| 28M-7     | 7314151834647 | 5  | 56  |
| 28M-8     | 7314151834654 | 5  | 56  |
| 28M-9     | 7314151834661 | 5  | 56  |
| 28M/11    | 7314151838126 | 1  | 57  |
| 28M/12    | 7314151838133 | 1  | 57  |
| 28M/15    | 7314151838140 | 1  | 57  |
| 28M/8     | 7314151838119 | 1  | 57  |
| 28MV-10   | 7314150121298 | 2  | 501 |
| 28MV-11   | 7314150121304 | 2  | 501 |
| 28MV-12   | 7314150121311 | 2  | 501 |
| 28MV-13   | 7314150121328 | 2  | 501 |
| 28MV-14   | 7314150121335 | 2  | 501 |
| 28MV-15   | 7314150121342 | 2  | 501 |
| 28MV-16   | 7314150121359 | 2  | 501 |
| 28MV-17   | 7314150121366 | 2  | 501 |



# 28MV-18



|            |               |   |     |
|------------|---------------|---|-----|
| 28MV-18    | 7314150121373 | 2 | 501 |
| 28MV-19    | 7314150121380 | 2 | 501 |
| 28MV-20    | 7314150121397 | 2 | 501 |
| 28MV-21    | 7314150121403 | 2 | 501 |
| 28MV-22    | 7314150121410 | 2 | 501 |
| 28MV-8     | 7314150121274 | 2 | 501 |
| 28MV-9     | 7314150121281 | 2 | 501 |
| 29-B       | 7311518277703 | 1 | 328 |
| 2900-140   | 7314150121045 | 3 | 250 |
| 2900-150   | 7314150034499 | 3 | 250 |
| 2900-180   | 7314150034512 | 3 | 250 |
| 2900-215   | 7314150034536 | 3 | 250 |
| 2900-300   | 7314150121076 | 1 | 250 |
| 2928-1     | 7314150056583 | 1 | 250 |
| 2928-160   | 7314150056514 | 1 | 250 |
| 2928-2     | 7314150056590 | 1 | 250 |
| 2928-200   | 7314150056521 | 1 | 250 |
| 2928-250   | 7314150056538 | 1 | 250 |
| 2928-3     | 7314150056606 | 1 | 250 |
| 2928-4     | 7314150056613 | 1 | 250 |
| 2949-190IP | 7314150123926 | 1 | 262 |
| 2949-200IP | 7314150123940 | 1 | 262 |
| 2949-240IP | 7314150123957 | 1 | 262 |
| 2949-250IP | 7314150123971 | 1 | 262 |
| 2949-L075  | 7314150440559 | 1 | 263 |
| 2949-L120  | 7314150440566 | 1 | 263 |
| 2949-L200  | 7314150440573 | 1 | 263 |
| 2950-250   | 7314150124039 | 1 | 261 |
| 2951-140   | 7314150124084 | 1 | 259 |
| 2951-180   | 7314150102204 | 1 | 259 |
| 2951-250   | 7314150102211 | 1 | 259 |
| 2951-300   | 7314150102228 | 1 | 259 |
| 2951-S05   | 7314150447299 | 1 | 262 |
| 2951-S07   | 7314150447305 | 1 | 262 |
| 2951-S10   | 7314150447312 | 1 | 262 |
| 2951-S12   | 7314150447329 | 1 | 262 |
| 2952-165   | 7314150103836 | 1 | 260 |
| 2952-235   | 7314150103843 | 1 | 260 |
| 2953-140   | 7314150124046 | 1 | 259 |
| 2953-200   | 7314150124053 | 1 | 259 |
| 2953-250   | 7314150124060 | 1 | 259 |
| 2953-300   | 7314150124077 | 1 | 259 |
| 2955-250   | 7314150102235 | 1 | 260 |
| 2956-290   | 7314150413690 | 1 | 261 |
| 2957-250   | 7314150102259 | 1 | 260 |
| 2958-140   | 7314150124107 | 1 | 259 |
| 2958-200   | 7314150124114 | 1 | 259 |
| 2958-250   | 7314150102242 | 1 | 259 |
| 296        | 7311518034146 | 1 | 567 |
| 2960-280   | 7314150412808 | 1 | 261 |
| 2962-8-150 | 7314150412815 | 1 | 261 |
| 2962-8-230 | 7314150413706 | 1 | 261 |
| 2962-8-300 | 7314150413713 | 1 | 261 |
| 2963-280   | 7314150102280 | 1 | 261 |
| 2963-450   | 7314150124138 | 1 | 261 |
| 2963-630   | 7314150124145 | 1 | 261 |
| 2964-160   | 7314150124183 | 1 | 261 |
| 2964-280   | 7314150102297 | 1 | 261 |
| 2964-450   | 7314150124190 | 1 | 261 |
| 2964-600   | 7314150124206 | 1 | 261 |
| 2965-200   | 7314150124152 | 1 | 262 |
| 2965-280   | 7314150102266 | 1 | 262 |
| 2966-280   | 7314150102273 | 1 | 262 |
| 2967-180   | 7314150102396 | 1 | 260 |
| 2968-190   | 7314150124091 | 1 | 259 |
| 2968-235   | 7314150103850 | 1 | 259 |
| 2970G-200  | 7314150134946 | 5 | 241 |
| 2971G-250  | 7314150117154 | 5 | 248 |
| 2979 D-180 | 7314150034246 | 5 | 246 |
| 2990-125   | 7314150121250 | 3 | 250 |
| 2990-140   | 7314150034482 | 3 | 250 |
| 2990-180   | 7314150034505 | 3 | 250 |
| 2990-200   | 7314150034529 | 3 | 250 |
| 2990-300   | 7314150121267 | 1 | 250 |
| 2997-250   | 7314150124237 | 1 | 262 |
| 2997-300   | 7314150124244 | 5 | 262 |
| 2998-250   | 7314150124213 | 1 | 260 |
| 2998-SHN   | 7314150447275 | 1 | 260 |
| 2999-250   | 7314150124169 | 1 | 260 |
| 2999-SHN   | 7314150447282 | 1 | 260 |
| 29M-10     | 7314150122318 | 5 | 57  |
| 29M-11     | 7314150122325 | 5 | 57  |
| 29M-12     | 7314150122332 | 5 | 57  |
| 29M-13     | 7314150122349 | 5 | 57  |
| 29M-14     | 7314150122356 | 5 | 57  |
| 29M-15     | 7314150122363 | 5 | 57  |
| 29M-16     | 7314150122370 | 5 | 57  |
| 29M-17     | 7314150122387 | 5 | 57  |
| 29M-18     | 7314150122394 | 3 | 57  |
| 29M-19     | 7314150122400 | 3 | 57  |
| 29M-20     | 7314150122417 | 3 | 57  |
| 29M-21     | 7314150122424 | 3 | 57  |
| 29M-22     | 7314150122431 | 3 | 57  |
| 29M-23     | 7314150122448 | 3 | 57  |
| 29M-24     | 7314150122455 | 3 | 57  |
| 29M-25     | 7314150122462 | 3 | 57  |



|                  |               |     |     |
|------------------|---------------|-----|-----|
| 29M-26           | 7314150122479 | 3   | 57  |
| 29M-27           | 7314150122486 | 3   | 57  |
| 29M-28           | 7314150122493 | 1   | 57  |
| 29M-29           | 7314150122509 | 1   | 57  |
| 29M-30           | 7314150122516 | 1   | 57  |
| 29M-32           | 7314150122523 | 1   | 57  |
| 29M-6            | 7314150122271 | 5   | 57  |
| 29M-7            | 7314150122288 | 5   | 57  |
| 29M-8            | 7314150122295 | 5   | 57  |
| 29M-9            | 7314150122301 | 5   | 57  |
| 29M/10           | 7314150122547 | 1   | 57  |
| 29M/14           | 7314150122554 | 1   | 57  |
| 29M/8            | 7314150122530 | 1   | 57  |
| 2M-10-11         | 7314151001223 | 5   | 52  |
| 2M-10-13         | 7314151001513 | 5   | 52  |
| 2M-12-13         | 7314151001230 | 5   | 52  |
| 2M-13-17         | 7314151343972 | 5   | 52  |
| 2M-14-15         | 7314151001247 | 5   | 52  |
| 2M-16-17         | 7314151001254 | 5   | 52  |
| 2M-16-18         | 7314151001575 | 5   | 52  |
| 2M-17-19         | 7314151000844 | 5   | 52  |
| 2M-18-19         | 7314151001261 | 5   | 52  |
| 2M-19-22         | 7314151000868 | 5   | 52  |
| 2M-20-22         | 7314151001278 | 5   | 52  |
| 2M-21-23         | 7314151001285 | 5   | 52  |
| 2M-22-24         | 7314151001612 | 5   | 52  |
| 2M-24-26         | 7314151001292 | 5   | 52  |
| 2M-24-27         | 7314151000899 | 5   | 52  |
| 2M-25-28         | 7314151001308 | 5   | 52  |
| 2M-27-29         | 7314150205332 | 5   | 52  |
| 2M-27-30         | 7314151001636 | 5   | 52  |
| 2M-27-32         | 7314151001322 | 5   | 52  |
| 2M-30-32         | 7314151000929 | 5   | 52  |
| 2M-32-36         | 7314151001667 | 1   | 52  |
| 2M-36-41         | 7314151001681 | 1   | 52  |
| 2M-41-46         | 7314151001704 | 1   | 52  |
| 2M-46-50         | 7314151001711 | 1   | 52  |
| 2M-6-7           | 7314151001209 | 5   | 52  |
| 2M-8-10          | 7314151001506 | 5   | 52  |
| 2M-8-9           | 7314151001216 | 5   | 52  |
| 2M/10T           | 7314150212996 | 1   | 52  |
| 2M/12T           | 7314151001414 | 1   | 53  |
| 2M/8T            | 7314151001391 | 1   | 52  |
| 2M/S8            | 7314151827335 | 1   | 52  |
| 2MV-10           | 7314150121113 | 5   | 501 |
| 2MV-11           | 7314150121120 | 5   | 501 |
| 2MV-12           | 7314150121137 | 5   | 501 |
| 2MV-13           | 7314150121144 | 5   | 501 |
| 2MV-14           | 7314150121151 | 5   | 501 |
| 2MV-15           | 7314150121168 | 5   | 501 |
| 2MV-16           | 7314150121175 | 5   | 501 |
| 2MV-17           | 7314150121182 | 3   | 501 |
| 2MV-18           | 7314150121199 | 3   | 501 |
| 2MV-19           | 7314150121205 | 3   | 501 |
| 2MV-21           | 7314150121212 | 3   | 501 |
| 2MV-22           | 7314150121229 | 3   | 501 |
| 2MV-23           | 7314150121236 | 3   | 501 |
| 2MV-24           | 7314150121243 | 3   | 501 |
| 2MV-6            | 7314150121069 | 5   | 501 |
| 2MV-7            | 7314150121083 | 5   | 501 |
| 2MV-8            | 7314150121090 | 5   | 501 |
| 2MV-9            | 7314150121106 | 5   | 501 |
| 2Z-1-1.1/8       | 7314151001827 | 1   | 52  |
| 2Z-1.1/16-1.1/4  | 7314151001834 | 1   | 52  |
| 2Z-1/2-9/16      | 7314151001445 | 1   | 52  |
| 2Z-1/4-5/16      | 7314151001421 | 1   | 52  |
| 2Z-13/16-7/8     | 7314151001797 | 1   | 52  |
| 2Z-15/16-1       | 7314151001810 | 1   | 52  |
| 2Z-3/4-7/8       | 7314151001773 | 1   | 52  |
| 2Z-3/8-7/16      | 7314151001438 | 1   | 52  |
| 2Z-5/16-3/8      | 7314151001728 | 1   | 52  |
| 2Z-5/8-11/16     | 7314151001452 | 1   | 52  |
| 2Z-9/16-5/8      | 7314151001735 | 1   | 52  |
| 2Z/7T            | 7314150217373 | 1   | 53  |
| 3-24-51          | 7315962500028 | 5   | 633 |
| 3-330-12-1-0     | 7311518020712 | 5   | 31  |
| 3-330-12-2-0     | 7311518020729 | 5   | 31  |
| 3-330-14-1-0     | 7311518020736 | 5   | 31  |
| 3-330-14-2-0     | 7311518020743 | 5   | 31  |
| 3-331-14-1-0     | 7311518020750 | 5   | 31  |
| 300-14-F15/16-HP | 7311518005955 | 4   | 561 |
| 301              | 7311518001384 | 50  | 567 |
| 301-16           | 7314150456048 | 12  | 269 |
| 301-22           | 7311518293673 | 12  | 269 |
| 302              | 7311518013349 | 30  | 566 |
| 302-15-95        | 7314150486632 | 100 | 269 |
| 302-35           | 7311518293680 | 6   | 269 |
| 302-511W-12P     | 7311518207786 | 1   | 567 |
| 302-51W-12P      | 7311518013356 | 1   | 567 |
| 302-53W-12P      | 7311518013363 | 1   | 567 |
| 302-55W-12P      | 7311518013370 | 1   | 567 |
| 302-57W-12P      | 7311518013387 | 1   | 567 |
| 302-59W-12P      | 7311518207779 | 1   | 567 |
| 302-6X4P         | 7311518017590 | 1   | 567 |
| 302-71M-12P      | 7311518013394 | 1   | 567 |
| 302-73M-12P      | 7311518013400 | 1   | 567 |





|                 |               |    |     |
|-----------------|---------------|----|-----|
| 302-75M-12P     | 7311518013417 | 1  | 567 |
| 302-76-95       | 7314150188345 | 1  | 269 |
| 302-76N         | 7314150456307 | 6  | 269 |
| 302-77M-12P     | 7311518207793 | 1  | 567 |
| 302-81S-12P     | 7311518013677 | 1  | 567 |
| 302-83S-12P     | 7311518013684 | 1  | 567 |
| 302-85S-12P     | 7311518207809 | 1  | 567 |
| 302-95-SET      | 7314150456321 | 1  | 269 |
| 303-5P          | 7311518031435 | 10 | 567 |
| 304             | 7311518265533 | 10 | 556 |
| 3045/1VDE       | 7314151783815 | 1  | 504 |
| 3045V-1         | 7314150128785 | 1  | 504 |
| 3045V-2         | 7314150128792 | 1  | 504 |
| 3046-OP         | 7311518276980 | 12 | 361 |
| 3046-REF        | 7311518276966 | 1  | 309 |
| 3049-2          | 7314151848118 | 1  | 464 |
| 306             | 7311518265540 | 10 | 556 |
| 306-10          | 7314150120246 | 1  | 268 |
| 306-12          | 7314150120253 | 1  | 268 |
| 306-15          | 7311518297107 | 12 | 268 |
| 306-15-95       | 7311518297329 | 1  | 269 |
| 306-22          | 7311518297114 | 12 | 268 |
| 306601500       | 8413345098700 | 5  | 588 |
| 306602000       | 8413345098717 | 5  | 588 |
| 306603000       | 8413345217033 | 5  | 588 |
| 306604000       | 8413345217095 | 5  | 588 |
| 306703000       | 8413345217194 | 5  | 588 |
| 306704000       | 8413345098755 | 5  | 588 |
| 306705000       | 8413345098762 | 5  | 588 |
| 306706000       | 8413345098779 | 5  | 588 |
| 306708000       | 8413345098786 | 5  | 588 |
| 306710000       | 8413345098793 | 5  | 588 |
| 306712000       | 8413345123334 | 2  | 588 |
| 306715000       | 8413345123341 | 2  | 588 |
| 306803000       | 8413345098809 | 5  | 588 |
| 306804000       | 8413345098816 | 5  | 588 |
| 306805000       | 8413345098823 | 2  | 588 |
| 306806000       | 8413345098830 | 2  | 588 |
| 306808000       | 8413345098847 | 2  | 588 |
| 306810000       | 8413345098854 | 2  | 588 |
| 306812000       | 8413345098861 | 2  | 588 |
| 306815000       | 8413345098878 | 1  | 588 |
| 306820000       | 8413345098885 | 1  | 588 |
| 306903000       | 8413345123402 | 2  | 588 |
| 306904000       | 8413345123419 | 2  | 588 |
| 306905000       | 8413345123426 | 2  | 588 |
| 306906000       | 8413345123433 | 2  | 588 |
| 306908000       | 8413345123457 | 2  | 588 |
| 306910000       | 8413345123471 | 2  | 588 |
| 307401B         | 7314150254958 | 1  | 268 |
| 307411B         | 7314150254965 | 1  | 268 |
| 307421B         | 7314150254972 | 1  | 268 |
| 307431B         | 7314150254989 | 1  | 268 |
| 307441          | 7314150235933 | 1  | 268 |
| 307451          | 7314150235940 | 1  | 268 |
| 308504000       | 8413345035156 | 1  | 544 |
| 308505000       | 8413345035194 | 1  | 544 |
| 308506000       | 8413345035163 | 1  | 544 |
| 308508000       | 8413345035170 | 1  | 544 |
| 308510000       | 8413345035187 | 1  | 544 |
| 3090-20-XT11-HP | 7311518181369 | 4  | 563 |
| 31              | 7314150004942 | 5  | 40  |
| 31 IP           | 7314150004959 | 50 | 40  |
| 31-T            | 7314150483709 | 5  | 40  |
| 31-T IP         | 7314150483723 | 50 | 40  |
| 3100TB          | 7314150125364 | 1  | 466 |
| 310M-24         | 7314151829612 | 1  | 56  |
| 310M-27         | 7314151829629 | 1  | 56  |
| 310M-30         | 7314151829636 | 1  | 56  |
| 310M-32         | 7314151829643 | 1  | 56  |
| 310M-36         | 7314151829650 | 1  | 56  |
| 310M-38         | 7314151829667 | 1  | 56  |
| 310M-41         | 7314151829674 | 1  | 56  |
| 310M-46         | 7314151829681 | 1  | 56  |
| 310M-50         | 7314151829698 | 1  | 56  |
| 310M-55         | 7314151829704 | 1  | 56  |
| 310M-60         | 7314151829711 | 1  | 56  |
| 310M-65         | 7314151829728 | 1  | 56  |
| 310M-70         | 7314151829735 | 1  | 56  |
| 310M-75         | 7314151829742 | 1  | 56  |
| 310M-80         | 7314151829759 | 1  | 56  |
| 310M-85         | 7314151829766 | 1  | 56  |
| 310M-90         | 7314151829773 | 1  | 56  |
| 310M-95         | 7314151829780 | 1  | 56  |
| 311-32          | 7314150120215 | 6  | 270 |
| 3115            | 7314150055326 | 1  | 364 |
| 3149-OR         | 7311518292249 | 1  | 461 |
| 3149-ORFF1      | 7314150292479 | 1  | 460 |
| 3149-ORTS1      | 7314150292066 | 1  | 461 |
| 3150-12-XT9-HP  | 7311518181406 | 4  | 560 |
| 315M-27         | 7314150133291 | 1  | 56  |
| 315M-30         | 7314150133307 | 1  | 56  |
| 315M-32         | 7314150133314 | 1  | 56  |
| 315M-36         | 7314150133321 | 1  | 56  |
| 315M-41         | 7314150133345 | 1  | 56  |
| 315M-46         | 7314150133352 | 1  | 56  |



|                 |               |    |     |
|-----------------|---------------|----|-----|
| 315M-50         | 7314150133369 | 1  | 56  |
| 315M-55         | 7314150133376 | 1  | 56  |
| 315M-60         | 7314150133383 | 1  | 56  |
| 315M-65         | 7314150133390 | 1  | 56  |
| 315M-70         | 7314150133406 | 1  | 56  |
| 315M-75         | 7314150133413 | 1  | 56  |
| 315M-80         | 7314150133420 | 1  | 56  |
| 315Z-1.1/16     | 7314150133437 | 1  | 56  |
| 315Z-1.1/2      | 7314150133505 | 1  | 56  |
| 315Z-1.1/4      | 7314150133468 | 1  | 56  |
| 315Z-1.1/8      | 7314150133444 | 1  | 56  |
| 315Z-1.11/16    | 7314150133529 | 1  | 56  |
| 315Z-1.13/16    | 7314150133543 | 1  | 56  |
| 315Z-1.15/16    | 7314150133567 | 1  | 56  |
| 315Z-1.3/16     | 7314150133451 | 1  | 56  |
| 315Z-1.3/4      | 7314150133536 | 1  | 56  |
| 315Z-1.3/8      | 7314150133482 | 1  | 56  |
| 315Z-1.5/16     | 7314150133475 | 1  | 56  |
| 315Z-1.5/8      | 7314150133512 | 1  | 56  |
| 315Z-1.7/16     | 7314150133499 | 1  | 56  |
| 315Z-1.7/8      | 7314150133550 | 1  | 56  |
| 315Z-2          | 7314150133574 | 1  | 56  |
| 315Z-2.1/16     | 7314150133581 | 1  | 56  |
| 315Z-2.1/2      | 7314150133642 | 1  | 56  |
| 315Z-2.1/4      | 7314150133611 | 1  | 56  |
| 315Z-2.1/8      | 7314150133598 | 1  | 56  |
| 315Z-2.15/16    | 7314150133697 | 1  | 56  |
| 315Z-2.3/16     | 7314150133604 | 1  | 56  |
| 315Z-2.3/4      | 7314150133673 | 1  | 56  |
| 315Z-2.3/8      | 7314150133635 | 1  | 56  |
| 315Z-2.5/16     | 7314150133628 | 1  | 56  |
| 315Z-2.5/8      | 7314150133666 | 1  | 56  |
| 315Z-2.7/8      | 7314150133680 | 1  | 56  |
| 315Z-2.9/16     | 7314150133659 | 1  | 56  |
| 315Z-3          | 7314150133703 | 1  | 56  |
| 315Z-3.1/8      | 7314150133840 | 1  | 56  |
| 316-1           | 7311518296216 | 12 | 271 |
| 316-2           | 7311518296223 | 12 | 271 |
| 316-2-95        | 7311518296278 | 1  | 271 |
| 317             | 7311518240936 | 10 | 556 |
| 317-40          | 7311518296230 | 12 | 271 |
| 318-38          | 7311518296247 | 1  | 271 |
| 318-54          | 7311518296254 | 1  | 271 |
| 3180-14-XT11-HP | 7311518181390 | 4  | 562 |
| 319             | 7311518240943 | 5  | 556 |
| 320             | 7311518265557 | 10 | 556 |
| 321             | 7311518001841 | 5  | 556 |
| 321-18-SB       | 7311518129125 | 10 | 558 |
| 321-24-SB       | 7311518129132 | 10 | 558 |
| 321-7-SB        | 7311518129149 | 10 | 558 |
| 322500300       | 8413345012829 | 1  | 535 |
| 322500500       | 8413345012836 | 1  | 535 |
| 322500800       | 8413345012843 | 1  | 535 |
| 322510300       | 8413345015899 | 1  | 535 |
| 322510400       | 8413345137386 | 1  | 535 |
| 322510500       | 8413345015905 | 1  | 535 |
| 322510600       | 8413345137393 | 1  | 535 |
| 322510700       | 8413345137409 | 1  | 535 |
| 322510800       | 8413345015912 | 1  | 535 |
| 3240-14-XT11-HP | 7311518243005 | 4  | 562 |
| 325             | 7311518214852 | 5  | 556 |
| 325001000       | 8413345000505 | 1  | 535 |
| 3250010SH       | 8413345137492 | 1  | 535 |
| 326000200       | 8413345000529 | 1  | 535 |
| 326000300       | 8413345012881 | 1  | 535 |
| 326010200       | 8413345016100 | 1  | 535 |
| 326020200       | 8413345016117 | 1  | 535 |
| 326030200       | 8413345016124 | 1  | 535 |
| 327020500       | 7314150330584 | 1  | 535 |
| 327020500-SH1   | 7314150361021 | 1  | 535 |
| 327020500-SH2   | 7314150361038 | 1  | 535 |
| 327020500-SH3   | 7314150361045 | 1  | 535 |
| 327020500-SH4   | 7314150361052 | 1  | 535 |
| 3280M           | 7314151071318 | 1  | 50  |
| 329000330       | 8413345000741 | 1  | 535 |
| 329000500       | 8413345000758 | 1  | 535 |
| 331-15-23       | 7311518274658 | 5  | 633 |
| 331-21-51-KP    | 7311518003814 | 5  | 633 |
| 332-21-51       | 7311518229337 | 5  | 633 |
| 333             | 7311518005832 | 5  | 633 |
| 333-5           | 7311518005849 | 10 | 634 |
| 339-6T          | 7311518128371 | 4  | 629 |
| 33H             | 7314150266791 | 5  | 40  |
| 340-6T          | 7311518002008 | 4  | 629 |
| 341             | 7314150113729 | 1  | 266 |
| 3416 A          | 7314150216260 | 6  | 252 |
| 3416 A SH       | 7314150410941 | 1  | 252 |
| 3416 B          | 7314150411160 | 10 | 252 |
| 3416 B SH       | 7314150411191 | 10 | 252 |
| 3417 A          | 7314150216277 | 12 | 253 |
| 3418 A          | 7314150216284 | 1  | 252 |
| 3419 B          | 7314151812416 | 1  | 254 |
| 3419 B SH       | 7314150504381 | 1  | 254 |
| 341A            | 7314150476268 | 5  | 653 |
| 342             | 7314150113736 | 1  | 266 |
| 343             | 7314150113743 | 1  | 266 |





|             |               |     |     |
|-------------|---------------|-----|-----|
| 344         | 7314150113750 | 1   | 266 |
| 349         | 7311518018924 | 4   | 634 |
| 3517 A      | 7314150410910 | 1   | 253 |
| 3518 A      | 7314150216376 | 1   | 253 |
| 3518 A SH   | 7314150216383 | 1   | 253 |
| 3518 B      | 7314150410927 | 1   | 253 |
| 3520 A      | 7314150410934 | 1   | 252 |
| 3520 A SH   | 7314150410958 | 1   | 252 |
| 3520 B      | 7314150411177 | 10  | 252 |
| 3520 B SH   | 7314150411207 | 10  | 252 |
| 3524        | 7314151073336 | 1   | 536 |
| 3524L-K     | 7314151339807 | 1   | 536 |
| 3525HB      | 7314151073350 | 5   | 536 |
| 36          | 7314150223381 | 5   | 593 |
| 361-10      | 7311518295202 | 1   | 267 |
| 361-12      | 7311518295219 | 1   | 267 |
| 361-14      | 7311518295226 | 1   | 267 |
| 361-18      | 7311518295233 | 1   | 267 |
| 361-24      | 7311518295240 | 1   | 267 |
| 361-36      | 7311518295257 | 1   | 267 |
| 361-8       | 7311518295196 | 1   | 267 |
| 3619 A      | 7314150411184 | 10  | 253 |
| 3619 A SH   | 7314150411214 | 10  | 253 |
| 3625AR-35   | 7314150214723 | 34  | 596 |
| 3625AR-50   | 7314150214730 | 18  | 596 |
| 3625AR-60   | 7314150214747 | 12  | 596 |
| 3625ARL-35  | 7314150214754 | 6   | 596 |
| 3625ARL-50  | 7314150214761 | 6   | 596 |
| 3625ARL-60  | 7314150214778 | 6   | 596 |
| 3625ARLH-35 | 7314150218677 | 80  | 597 |
| 3625ARLH-50 | 7314150218684 | 50  | 597 |
| 3625ARLH-60 | 7314150218691 | 16  | 597 |
| 3625N-22    | 7314151073602 | 6   | 597 |
| 3625N-32    | 7314151073640 | 6   | 597 |
| 3625N-40    | 7314151073688 | 6   | 597 |
| 3625N-50    | 7314151073701 | 6   | 597 |
| 3625NL-22   | 7314151073831 | 20  | 598 |
| 3625NL-32   | 7314151073855 | 20  | 598 |
| 3625NL-40   | 7314151073879 | 20  | 598 |
| 3625NL-50   | 7314151073886 | 20  | 598 |
| 3625PU-105  | 7314150170098 | 4   | 597 |
| 3625PU-30   | 7311518276119 | 12  | 597 |
| 3625PU-50   | 7311518276126 | 6   | 597 |
| 3625PU-60   | 7311518276133 | 6   | 597 |
| 3625RM-55   | 7314150120758 | 50  | 598 |
| 3625RM-65   | 7314150120765 | 40  | 598 |
| 3625RM-75   | 7314153019820 | 30  | 598 |
| 3625RM-90   | 7314150120390 | 20  | 598 |
| 3625S-28    | 7314150183906 | 50  | 598 |
| 3625S-35    | 7314150183913 | 30  | 598 |
| 3625S-44    | 7314150183920 | 18  | 598 |
| 3625W-22    | 7314150120406 | 120 | 598 |
| 3625W-28    | 7314150120413 | 1   | 598 |
| 3625W-35    | 7314150120420 | 1   | 598 |
| 3625W-44    | 7314150120437 | 1   | 598 |
| 3625W-55    | 7314150120444 | 12  | 598 |
| 3625WL-22   | 7314150120451 | 10  | 598 |
| 3625WL-28   | 7314150120468 | 10  | 598 |
| 3625WL-35   | 7314150120475 | 10  | 598 |
| 3625WL-44   | 7314150120482 | 10  | 598 |
| 3625WL-55   | 7314150120499 | 6   | 598 |
| 3625WLH-22  | 7314150219025 | 50  | 598 |
| 3625WLH-28  | 7314150218981 | 50  | 598 |
| 3625WLH-35  | 7314150218998 | 80  | 598 |
| 3625WLH-44  | 7314150219001 | 50  | 598 |
| 3625WLH-55  | 7314150219018 | 16  | 598 |
| 3625Y-22    | 7314151074074 | 6   | 597 |
| 3625Y-32    | 7314151074098 | 6   | 597 |
| 3625Y-40    | 7314151074111 | 6   | 597 |
| 3625Y-50    | 7314151074128 | 6   | 597 |
| 3625YL-22   | 7314151074159 | 20  | 597 |
| 3625YL-32   | 7314151074173 | 20  | 597 |
| 3625YL-40   | 7314151074197 | 20  | 597 |
| 3625YL-50   | 7314151074203 | 20  | 597 |
| 363-32      | 7311518295578 | 1   | 268 |
| 3640-150-C  | 7314150180691 | 25  | 604 |
| 3640-200-C  | 7314150180714 | 25  | 604 |
| 3640-250-C  | 7314150180721 | 20  | 604 |
| 3640-300-C  | 7314150180738 | 25  | 604 |
| 3643-100    | 7314151074654 | 50  | 606 |
| 3643-120    | 7314151074678 | 50  | 606 |
| 3643-150    | 7314151074685 | 50  | 606 |
| 3644-120    | 7314151074708 | 50  | 606 |
| 3644-125    | 7314151074722 | 50  | 606 |
| 3644-130    | 7314151074746 | 50  | 606 |
| 3644-150    | 7314151074760 | 50  | 606 |
| 3644-165    | 7314151074777 | 50  | 606 |
| 3644-180    | 7314151074791 | 50  | 606 |
| 3644-200    | 7314151074807 | 50  | 606 |
| 3646-115    | 7314151074937 | 250 | 607 |
| 3646-125    | 7314151074944 | 250 | 607 |
| 3646-150    | 7314151074951 | 125 | 607 |
| 3646-165    | 7314151074968 | 125 | 607 |
| 3646-180    | 7314151074975 | 50  | 607 |
| 3646-200    | 7314151074982 | 50  | 607 |
| 3646/6      | 7314151074999 | 25  | 607 |



|              |               |     |     |
|--------------|---------------|-----|-----|
| 3649-125     | 7314150472413 | 50  | 604 |
| 3654BMS/7    | 7314150220816 | 1   | 610 |
| 3654R        | 7314151075132 | 1   | 607 |
| 3656-125     | 7314150472352 | 50  | 604 |
| 3656-150     | 7314150472376 | 50  | 604 |
| 3656-175     | 7314150472390 | 1   | 604 |
| 3656/10      | 7314151075279 | 1   | 608 |
| 3658A-2      | 7314151075293 | 125 | 607 |
| 3658A-3      | 7314151075309 | 125 | 607 |
| 3658A-4      | 7314151075316 | 125 | 607 |
| 3658A-5      | 7314151075323 | 125 | 607 |
| 3658A-6      | 7314151075330 | 125 | 607 |
| 3658A-8      | 7314151075347 | 50  | 607 |
| 3658A/6      | 7314151075354 | 30  | 608 |
| 3659-0.9     | 7314151075507 | 5   | 607 |
| 3659-1.4     | 7314151075514 | 5   | 607 |
| 3659-1.8     | 7314151597351 | 5   | 607 |
| 3659-2.4     | 7314151075538 | 5   | 607 |
| 3659-2.8     | 7314151597436 | 5   | 607 |
| 3659-3.4     | 7314151075552 | 5   | 607 |
| 3659-3.9     | 7314151075569 | 5   | 607 |
| 3659-6.0     | 7314151075576 | 5   | 607 |
| 3659/8       | 7314151075583 | 1   | 608 |
| 3659/8T      | 7314151472573 | 1   | 608 |
| 3680         | 7314151075835 | 1   | 370 |
| 3681-11      | 7314150132980 | 1   | 371 |
| 3681-16      | 7314150132997 | 1   | 371 |
| 3681-20      | 7314150133000 | 1   | 371 |
| 3683         | 7314151075866 | 1   | 370 |
| 3684-16      | 7314150133017 | 1   | 370 |
| 3684-18      | 7314150133024 | 1   | 370 |
| 3684-24      | 7314150133031 | 1   | 370 |
| 3684-30      | 7314150133048 | 1   | 370 |
| 369-BLADE    | 7311518016531 | 20  | 561 |
| 370-4        | 7311518296193 | 1   | 268 |
| 3717 A       | 7314150489916 | 1   | 253 |
| 3718 A       | 7314150489930 | 12  | 254 |
| 3719 A       | 7314150489954 | 12  | 254 |
| 372-1.1/2    | 7314150133239 | 1   | 267 |
| 372-12       | 7314150133284 | 1   | 267 |
| 372-2.1/2    | 7314150133246 | 1   | 267 |
| 372-4        | 7314150133253 | 1   | 267 |
| 372-6        | 7314150133260 | 1   | 267 |
| 372-8        | 7314150133277 | 1   | 267 |
| 3733-2       | 7314151834371 | 50  | 607 |
| 3733-3       | 7314151834388 | 50  | 607 |
| 3733-4       | 7314151834395 | 50  | 607 |
| 3733-5       | 7314151834401 | 50  | 607 |
| 3733-6       | 7314151834418 | 50  | 607 |
| 3733S/5      | 7314150220809 | 25  | 608 |
| 3734-2       | 7314151834296 | 50  | 607 |
| 3734-3       | 7314151834319 | 50  | 607 |
| 3734-4       | 7314151834326 | 50  | 607 |
| 3734-5       | 7314151834333 | 50  | 607 |
| 3734-6       | 7314151834340 | 50  | 607 |
| 3734-8       | 7314151834357 | 50  | 607 |
| 3734BMS/7    | 7314150220755 | 1   | 610 |
| 3734N-10-150 | 7314150218110 | 10  | 607 |
| 3734N-2-150  | 7314150218042 | 10  | 607 |
| 3734N-3-150  | 7314150218059 | 10  | 607 |
| 3734N-4-150  | 7314150218066 | 10  | 607 |
| 3734N-5-150  | 7314150218073 | 10  | 607 |
| 3734N-6-150  | 7314150218080 | 10  | 607 |
| 3734N-7-150  | 7314150218097 | 10  | 607 |
| 3734N-8-150  | 7314150218103 | 10  | 607 |
| 3734N-9-150  | 7314150218127 | 10  | 607 |
| 3734NS/9     | 7314150218134 | 10  | 608 |
| 3734S/6      | 7314151834470 | 5   | 608 |
| 3735-4-120   | 7314151834265 | 50  | 606 |
| 3735-5-120   | 7314151834272 | 50  | 606 |
| 3735-5-150   | 7314151834289 | 50  | 606 |
| 3735N-2-100  | 7314150217953 | 10  | 606 |
| 3735N-4-120  | 7314150217960 | 10  | 606 |
| 3735N-5-120  | 7314150217977 | 10  | 606 |
| 3735N-6-150  | 7314150217984 | 10  | 606 |
| 3735N-8-150  | 7314150217991 | 10  | 606 |
| 3735NS/4     | 7314150218004 | 25  | 606 |
| 3736M-200    | 7314150220878 | 30  | 605 |
| 3736M-250    | 7314151834142 | 25  | 605 |
| 3736M-300    | 7314151834159 | 10  | 605 |
| 3736M-400    | 7314151834166 | 10  | 605 |
| 3736MH-250   | 7314151834173 | 10  | 605 |
| 3736MH-300   | 7314151834180 | 10  | 605 |
| 3736MH-400   | 7314151834197 | 5   | 605 |
| 3736S/6      | 7314151834463 | 5   | 605 |
| 3739-250     | 7314151834203 | 25  | 605 |
| 3739-300     | 7314151834210 | 10  | 605 |
| 3739-400     | 7314151834227 | 10  | 605 |
| 3739H-250    | 7314151834234 | 15  | 605 |
| 3739H-300    | 7314151834241 | 10  | 605 |
| 3739H-400    | 7314151834258 | 10  | 605 |
| 3740-100     | 7314151834005 | 50  | 604 |
| 3740-125     | 7314151834012 | 50  | 604 |
| 3740-150     | 7314151834029 | 50  | 604 |
| 3740-175     | 7314151834036 | 25  | 604 |
| 3740-200     | 7314151834043 | 25  | 604 |



|                        |               |    |     |
|------------------------|---------------|----|-----|
| 3740-250               | 7314151834050 | 10 | 604 |
| 3740-300               | 7314151834067 | 10 | 604 |
| 3745-150               | 7314151834081 | 50 | 604 |
| 3745-175               | 7314151834098 | 25 | 604 |
| 3745-200               | 7314151834104 | 20 | 604 |
| 3745-250               | 7314151834111 | 10 | 604 |
| 3749-125               | 7314150457915 | 50 | 604 |
| 375-8                  | 7311518296209 | 1  | 268 |
| 3750                   | 7314151834128 | 25 | 604 |
| 3750H                  | 7314151834135 | 25 | 605 |
| 3756-125               | 7314150457892 | 50 | 604 |
| 3756-150               | 7314150457908 | 50 | 604 |
| 38-12                  | 7314151831264 | 5  | 331 |
| 38-16                  | 7314151831271 | 5  | 331 |
| 38-20                  | 7314151831288 | 2  | 331 |
| 38-24                  | 7314151831295 | 1  | 331 |
| 38-8                   | 7314151831257 | 5  | 331 |
| 380-10                 | 7314150133178 | 1  | 267 |
| 380-14                 | 7314150133185 | 1  | 267 |
| 380-18                 | 7314150133192 | 1  | 267 |
| 380-24                 | 7314150133208 | 1  | 267 |
| 380-36                 | 7314150133215 | 1  | 267 |
| 380-48                 | 7314150133222 | 1  | 267 |
| 3802-300-25-1.25-10    | 7311518111229 | 10 | 19  |
| 3802-300-25-1.25-14    | 7311518111236 | 10 | 19  |
| 3802-300-25-1.25-6     | 7311518143299 | 10 | 19  |
| 3802-300-32-1.60-10    | 7311518111274 | 10 | 19  |
| 3802-300-32-1.60-6     | 7311518111298 | 10 | 19  |
| 3802-350-25-1.25-10    | 7311518111335 | 10 | 19  |
| 3802-350-25-1.25-14    | 7311518111342 | 10 | 19  |
| 3802-350-25-1.25-6     | 7311518111359 | 10 | 19  |
| 3802-350-32-1.60-10    | 7311518111397 | 10 | 19  |
| 3802-350-32-1.60-14    | 7311518111403 | 10 | 19  |
| 3802-350-32-1.60-4     | 7311518111410 | 10 | 19  |
| 3802-350-32-1.60-6     | 7311518111427 | 10 | 19  |
| 3802-350-32-1.60-8     | 7311518140908 | 10 | 19  |
| 3802-400-25-1.25-10    | 7311518111496 | 10 | 19  |
| 3802-400-25-1.25-14    | 7311518111502 | 10 | 19  |
| 3802-400-25-1.25-6     | 7311518111519 | 10 | 19  |
| 3802-400-32-1.60-10    | 7311518111557 | 10 | 19  |
| 3802-400-32-1.60-14    | 7311518111564 | 10 | 19  |
| 3802-400-32-1.60-4     | 7311518111571 | 10 | 19  |
| 3802-400-32-1.60-6     | 7311518111588 | 10 | 19  |
| 3802-400-32-1.60-8     | 7311518111595 | 10 | 19  |
| 3802-400-38-2.00-10    | 7311518111649 | 10 | 19  |
| 3802-400-38-2.00-4     | 7311518111656 | 10 | 19  |
| 3802-400-38-2.00-6     | 7311518111663 | 10 | 19  |
| 3802-425-32-1.60-10    | 7311518111694 | 10 | 19  |
| 3802-425-32-1.60-6     | 7311518111700 | 10 | 19  |
| 3802-450-32-1.60-10    | 7311518111731 | 10 | 19  |
| 3802-450-32-1.60-14    | 7311518111748 | 10 | 19  |
| 3802-450-32-1.60-4     | 7311518111755 | 10 | 19  |
| 3802-450-32-1.60-6     | 7311518111762 | 10 | 19  |
| 3802-450-38-2.00-10    | 7311518111816 | 10 | 19  |
| 3802-450-38-2.00-10-KA | 7311518111823 | 10 | 19  |
| 3802-450-38-2.00-4     | 7311518111830 | 10 | 19  |
| 3802-450-38-2.00-4-KA  | 7311518111847 | 10 | 19  |
| 3802-450-38-2.00-6     | 7311518111854 | 10 | 19  |
| 3802-450-38-2.00-6-KA  | 7311518111861 | 10 | 19  |
| 3802-450-38-2.00-8     | 7311518111878 | 10 | 19  |
| 3802-450-38-2.00-8-KA  | 7311518111885 | 10 | 19  |
| 3802-475-38-2.00-8     | 7311518113117 | 10 | 19  |
| 3802-500-38-2.00-10    | 7311518111953 | 10 | 19  |
| 3802-500-38-2.00-4     | 7311518111960 | 10 | 19  |
| 3802-500-38-2.00-6     | 7311518111977 | 10 | 19  |
| 3802-500-38-2.00-8     | 7311518113070 | 10 | 19  |
| 3802-500-45-2.25-10    | 7311518111984 | 10 | 19  |
| 3802-500-50-2.50-4     | 7311518112028 | 10 | 19  |
| 3802-500-50-2.50-4-KA  | 7311518112035 | 10 | 19  |
| 3802-500-50-2.50-6     | 7311518112042 | 10 | 19  |
| 3802-500-50-2.50-6-KA  | 7311518112059 | 10 | 19  |
| 3802-525-38-2.00-10    | 7311518112073 | 10 | 19  |
| 3802-525-38-2.00-6     | 7311518112097 | 10 | 19  |
| 3802-525-38-2.00-8     | 7311518112103 | 10 | 19  |
| 3802-550-38-2.00-6     | 7311518112158 | 10 | 19  |
| 3802-550-50-2.50-10    | 7311518112196 | 10 | 19  |
| 3802-550-50-2.50-4     | 7311518112202 | 10 | 19  |
| 3802-550-50-2.50-4-KA  | 7311518112219 | 10 | 19  |
| 3802-550-50-2.50-6     | 7311518112226 | 10 | 19  |
| 3802-550-50-2.50-8     | 7311518112240 | 5  | 19  |
| 3802-550-50-2.50-8-KA  | 7311518113315 | 10 | 19  |
| 3802-575-50-2.50-3-KA  | 7311518112301 | 10 | 19  |
| 3802-575-50-2.50-4     | 7311518112318 | 10 | 19  |
| 3802-575-50-2.50-4-KA  | 7311518112325 | 10 | 19  |
| 3802-575-50-2.50-6     | 7311518112332 | 10 | 19  |
| 3802-575-50-2.50-6-KA  | 7311518112349 | 10 | 19  |
| 3802-600-50-2.50-4     | 7311518112417 | 10 | 19  |
| 3802-600-50-2.50-6     | 7311518112431 | 10 | 19  |
| 3802-600-50-2.50-8     | 7311518112455 | 10 | 19  |
| 3802-650-50-2.50-4     | 7311518112509 | 5  | 19  |
| 3802-650-50-2.50-4-KA  | 7311518112523 | 5  | 19  |
| 3802-650-50-2.50-6     | 7311518112530 | 5  | 19  |
| 3802-650-50-2.50-6-KA  | 7311518112554 | 5  | 19  |
| 3802-700-50-2.50-2-KA  | 7311518112578 | 5  | 19  |
| 3802-700-50-2.50-3     | 7311518112585 | 5  | 19  |
| 3802-700-50-2.50-4     | 7311518112608 | 5  | 19  |



|                        |               |    |     |
|------------------------|---------------|----|-----|
| 3802-700-50-2.50-4-KA  | 7311518112615 | 5  | 19  |
| 3802-700-50-2.50-6     | 7311518112622 | 5  | 19  |
| 3802-700-50-2.50-6-KA  | 7311518112639 | 5  | 19  |
| 3802-750-50-2.50-4     | 7311518112660 | 5  | 19  |
| 3802-750-50-2.50-6     | 7311518112677 | 5  | 19  |
| 3806-600-32            | 7311518018092 | 10 | 557 |
| 3809-300-25-1.25-10    | 7311518113711 | 10 | 18  |
| 3809-300-25-1.25-14    | 7311518113728 | 10 | 18  |
| 3809-300-32-1.60-10    | 7311518113735 | 10 | 18  |
| 3809-300-32-1.60-6     | 7311518113742 | 10 | 18  |
| 3809-350-25-1.25-10    | 7311518113759 | 10 | 18  |
| 3809-350-25-1.25-14    | 7311518113766 | 10 | 18  |
| 3809-350-25-1.25-6     | 7311518113773 | 10 | 18  |
| 3809-350-32-1.60-10    | 7311518113780 | 10 | 18  |
| 3809-350-32-1.60-14    | 7311518113797 | 10 | 18  |
| 3809-350-32-1.60-4     | 7311518113803 | 10 | 18  |
| 3809-350-32-1.60-6     | 7311518113810 | 10 | 18  |
| 3809-350-32-1.60-8     | 7311518113827 | 10 | 18  |
| 3809-350-32-2.00-10    | 7311518113834 | 10 | 18  |
| 3809-350-32-2.00-4     | 7311518113841 | 10 | 18  |
| 3809-350-32-2.00-6     | 7311518113858 | 10 | 18  |
| 3809-350-38-2.00-10    | 7311518113865 | 10 | 18  |
| 3809-350-38-2.00-6     | 7311518113896 | 10 | 18  |
| 3809-400-25-1.25-10    | 7311518178666 | 10 | 18  |
| 3809-400-32-1.60-10    | 7311518113896 | 10 | 18  |
| 3809-400-32-1.60-14    | 7311518113902 | 10 | 18  |
| 3809-400-32-1.60-4     | 7311518113919 | 10 | 18  |
| 3809-400-32-1.60-6     | 7311518113933 | 10 | 18  |
| 3809-400-32-1.60-8     | 7311518113940 | 10 | 18  |
| 3809-400-32-2.00-10    | 7311518113957 | 10 | 18  |
| 3809-400-32-2.00-4     | 7311518113964 | 10 | 18  |
| 3809-400-32-2.00-6     | 7311518113971 | 10 | 18  |
| 3809-400-32-2.00-6-KA  | 7311518158248 | 10 | 19  |
| 3809-400-32-2.00-8     | 7311518114152 | 10 | 18  |
| 3809-400-38-2.00-10    | 7311518113988 | 10 | 18  |
| 3809-400-38-2.00-4     | 7311518113995 | 10 | 18  |
| 3809-400-38-2.00-6     | 7311518114008 | 10 | 18  |
| 3809-425-32-1.60-10    | 7311518114015 | 10 | 18  |
| 3809-425-32-1.60-6     | 7311518197759 | 10 | 18  |
| 3809-450-32-1.60-10    | 7311518114022 | 10 | 18  |
| 3809-450-32-1.60-14    | 7311518114039 | 10 | 18  |
| 3809-450-32-1.60-4     | 7311518114046 | 10 | 18  |
| 3809-450-32-1.60-6     | 7311518114053 | 10 | 18  |
| 3809-450-32-2.00-10    | 7311518114060 | 10 | 18  |
| 3809-450-32-2.00-4     | 7311518114077 | 10 | 18  |
| 3809-450-32-2.00-6     | 7311518114084 | 10 | 18  |
| 3809-450-38-2.00-10    | 7311518114091 | 10 | 18  |
| 3809-450-38-2.00-10-KA | 7311518114107 | 10 | 19  |
| 3809-450-38-2.00-4     | 7311518114114 | 10 | 18  |
| 3809-450-38-2.00-4-KA  | 7311518114121 | 10 | 19  |
| 3809-450-38-2.00-6     | 7311518114138 | 10 | 18  |
| 3809-450-38-2.00-6-KA  | 7311518114145 | 10 | 19  |
| 3809-450-38-2.00-8     | 7311518114176 | 10 | 18  |
| 3809-450-45-2.25-4     | 7311518114206 | 10 | 18  |
| 3809-450-45-2.25-6     | 7311518114213 | 10 | 18  |
| 3809-475-45-2.25-6     | 7311518114237 | 10 | 18  |
| 3809-500-38-2.00-10    | 7311518114244 | 10 | 18  |
| 3809-500-38-2.00-4     | 7311518114251 | 10 | 18  |
| 3809-500-38-2.00-6     | 7311518114268 | 10 | 18  |
| 3809-500-45-2.25-4     | 7311518114275 | 10 | 18  |
| 3809-500-45-2.25-6     | 7311518114299 | 10 | 18  |
| 3809-500-45-2.25-6-KA  | 7311518114305 | 10 | 19  |
| 3809-500-50-2.50-4     | 7311518114312 | 10 | 18  |
| 3809-500-50-2.50-4-KA  | 7311518114329 | 10 | 19  |
| 3809-500-50-2.50-6     | 7311518114336 | 10 | 18  |
| 3809-500-50-2.50-6-KA  | 7311518114343 | 10 | 19  |
| 3809-500-50-2.50-8     | 7311518114350 | 10 | 18  |
| 3809-525-38-2.00-10    | 7311518114367 | 10 | 18  |
| 3809-525-38-2.00-6     | 7311518114374 | 10 | 18  |
| 3809-525-45-2.25-4     | 7311518114381 | 10 | 18  |
| 3809-525-45-2.25-6     | 7311518114398 | 10 | 18  |
| 3809-550-45-2.25-4     | 7311518114411 | 10 | 18  |
| 3809-550-45-2.25-6     | 7311518114428 | 10 | 18  |
| 3809-550-50-2.50-4     | 7311518114435 | 10 | 18  |
| 3809-550-50-2.50-4-KA  | 7311518114442 | 10 | 19  |
| 3809-550-50-2.50-6     | 7311518114459 | 10 | 18  |
| 3809-550-50-2.50-6-KA  | 7311518114466 | 10 | 19  |
| 3809-575-45-2.25-4     | 7311518114473 | 10 | 18  |
| 3809-575-50-2.50-10-KA | 7311518114497 | 10 | 18  |
| 3809-575-50-2.50-3     | 7311518114602 | 10 | 18  |
| 3809-575-50-2.50-3-KA  | 7311518114503 | 10 | 19  |
| 3809-575-50-2.50-4     | 7311518114510 | 10 | 18  |
| 3809-575-50-2.50-4-KA  | 7311518114527 | 10 | 19  |
| 3809-575-50-2.50-6     | 7311518114534 | 10 | 18  |
| 3809-575-50-2.50-6-KA  | 7311518114541 | 10 | 19  |
| 3809-600-38-2.00-6     | 7311518227579 | 10 | 18  |
| 3809-600-45-2.25-4     | 7311518172275 | 10 | 18  |
| 3809-600-45-2.25-6     | 7311518114558 | 10 | 18  |
| 3809-600-50-2.50-3     | 7311518114565 | 10 | 18  |
| 3809-600-50-2.50-4     | 7311518114572 | 10 | 18  |
| 3809-600-50-2.50-4-KA  | 7311518114589 | 10 | 19  |
| 3809-600-50-2.50-6     | 7311518114596 | 10 | 18  |
| 3809-600-50-2.50-6-KA  | 7311518114626 | 10 | 19  |
| 3809-650-50-2.50-3-KA  | 7311518114640 | 5  | 19  |
| 3809-650-50-2.50-4     | 7311518114657 | 5  | 18  |
| 3809-650-50-2.50-4-KA  | 7311518114664 | 5  | 19  |





# 3809-650-50-2.50-6



|                        |               |     |     |
|------------------------|---------------|-----|-----|
| 3809-650-50-2.50-6     | 7311518114671 | 5   | 18  |
| 3809-650-50-2.50-6-KA  | 7311518114688 | 5   | 19  |
| 3809-700-50-2.50-3-KA  | 7311518114695 | 5   | 19  |
| 3809-700-50-2.50-4     | 7311518114701 | 5   | 18  |
| 3809-700-50-2.50-4-KA  | 7311518114718 | 5   | 19  |
| 3809-700-50-2.50-6     | 7311518114725 | 5   | 18  |
| 3809-700-50-2.50-6-KA  | 7311518114732 | 5   | 19  |
| 3809-750-50-2.50-4     | 7311518114749 | 5   | 18  |
| 3809-750-50-2.50-6     | 7311518234409 | 5   | 18  |
| 3815-200-2.0-32-1-03BW | 7311518160258 | 1   | 17  |
| 3815-200-2.0-32-1-04BW | 7311518160241 | 1   | 17  |
| 3815-225-2.0-32-1-03BW | 7311518160319 | 1   | 17  |
| 3815-225-2.0-32-1-04BW | 7311518158347 | 1   | 17  |
| 3815-225-2.0-32-1-05BW | 7311518160302 | 1   | 17  |
| 3815-225-2.0-32-1-06C  | 7311518160296 | 1   | 17  |
| 3815-250-2.0-32-1-03BW | 7311518160586 | 1   | 17  |
| 3815-250-2.0-32-1-04BW | 7311518160579 | 1   | 17  |
| 3815-250-2.0-32-1-05BW | 7311518158354 | 1   | 17  |
| 3815-250-2.0-32-1-06C  | 7311518160562 | 1   | 17  |
| 3815-250-2.0-40-2-03BW | 7311518160340 | 1   | 18  |
| 3815-250-2.0-40-2-04BW | 7311518174446 | 1   | 18  |
| 3815-250-2.0-40-2-05BW | 7311518160333 | 1   | 18  |
| 3815-275-2.5-32-1-04BW | 7311518160593 | 1   | 17  |
| 3815-275-2.5-32-1-05BW | 7311518158361 | 1   | 17  |
| 3815-275-2.5-32-1-06C  | 7311518174590 | 1   | 17  |
| 3815-275-2.5-32-1-08C  | 7311518174583 | 1   | 17  |
| 3815-275-2.5-40-2-03BW | 7311518176433 | 1   | 18  |
| 3815-275-2.5-40-2-04BW | 7311518160623 | 1   | 18  |
| 3815-275-2.5-40-2-05BW | 7311518158378 | 1   | 18  |
| 3815-275-2.5-40-2-06C  | 7311518160616 | 1   | 18  |
| 3815-275-2.5-40-2-08C  | 7311518160609 | 1   | 18  |
| 3815-300-2.5-32-1-04BW | 7311518160630 | 1   | 17  |
| 3815-300-2.5-32-1-05BW | 7311518158385 | 1   | 17  |
| 3815-300-2.5-32-1-05C  | 7311518174699 | 1   | 17  |
| 3815-300-2.5-32-1-06C  | 7311518174705 | 1   | 17  |
| 3815-300-2.5-32-1-08C  | 7311518174712 | 1   | 17  |
| 3815-315-2.5-32-1-04BW | 7311518160210 | 1   | 17  |
| 3815-315-2.5-32-1-05BW | 7311518160203 | 1   | 17  |
| 3815-315-2.5-32-1-06C  | 7311518160197 | 1   | 17  |
| 3815-315-2.5-32-1-08C  | 7311518160401 | 1   | 17  |
| 3815-315-2.5-40-2-04BW | 7311518160456 | 1   | 18  |
| 3815-315-2.5-40-2-05BW | 7311518160449 | 1   | 18  |
| 3815-315-3.0-40-2-06C  | 7311518174842 | 1   | 18  |
| 3815-350-2.5-32-1-04BW | 7311518197605 | 1   | 17  |
| 3815-350-2.5-32-1-06C  | 7311518197612 | 1   | 17  |
| 3815-370-3.0-50-4-08C  | 7311518174989 | 1   | 18  |
| 3815-370-3.0-50-4-10C  | 7311518174996 | 1   | 18  |
| 3815-400-3.5-50-4-10C  | 7311518160494 | 1   | 18  |
| 3816-300               | 7311518015749 | 50  | 558 |
| 3818-300-PROG-100      | 7311518288105 | 100 | 557 |
| 3818-300-PROG-5P       | 7314150265589 | 10  | 557 |
| 383-6T                 | 7311518128876 | 4   | 630 |
| 3830-102-C             | 7311518225612 | 1   | 124 |
| 3830-102-VIP           | 7311518042035 | 4   | 124 |
| 3830-105-C             | 7311518225629 | 1   | 124 |
| 3830-105-VIP           | 7311518042042 | 4   | 124 |
| 3830-108-C             | 7311518228521 | 1   | 124 |
| 3830-108-VIP           | 7311518042059 | 4   | 124 |
| 3830-111-C             | 7311518228538 | 1   | 124 |
| 3830-111-VIP           | 7311518042066 | 4   | 124 |
| 3830-114-C             | 7311518225636 | 1   | 124 |
| 3830-114-VIP           | 7311518042073 | 4   | 124 |
| 3830-121-C             | 7311518225643 | 1   | 124 |
| 3830-121-VIP           | 7311518042080 | 1   | 124 |
| 3830-127-C             | 7311518225650 | 1   | 124 |
| 3830-127-VIP           | 7311518042097 | 1   | 124 |
| 3830-133-C             | 7311518228545 | 1   | 124 |
| 3830-133-VIP           | 7311518042103 | 1   | 124 |
| 3830-14-C              | 7311518228347 | 1   | 124 |
| 3830-14-VIP            | 7311518041618 | 6   | 124 |
| 3830-140-C             | 7311518228552 | 1   | 124 |
| 3830-140-VIP           | 7311518042110 | 1   | 124 |
| 3830-146-C             | 7311518228569 | 1   | 124 |
| 3830-146-VIP           | 7311518042127 | 1   | 124 |
| 3830-152-C             | 7311518225667 | 1   | 124 |
| 3830-152-VIP           | 7311518042134 | 1   | 124 |
| 3830-16-C              | 7311518225353 | 1   | 124 |
| 3830-16-VIP            | 7311518041625 | 6   | 124 |
| 3830-168               | 7311518040659 | 1   | 124 |
| 3830-17-C              | 7311518228354 | 1   | 124 |
| 3830-17-VIP            | 7311518041632 | 6   | 124 |
| 3830-177-HIGH          | 7311518101329 | 1   | 124 |
| 3830-19-4P             | 7314150428557 | 1   | 124 |
| 3830-19-C              | 7311518225360 | 1   | 124 |
| 3830-19-VIP            | 7311518041649 | 6   | 124 |
| 3830-20-4P             | 7314150428601 | 1   | 124 |
| 3830-20-C              | 7311518225377 | 1   | 124 |
| 3830-20-VIP            | 7311518041656 | 6   | 124 |
| 3830-21-C              | 7311518228361 | 1   | 124 |
| 3830-21-VIP            | 7311518041663 | 6   | 124 |
| 3830-210               | 7311518040666 | 1   | 124 |
| 3830-22-4P             | 7314150428649 | 1   | 124 |
| 3830-22-C              | 7311518225384 | 1   | 124 |
| 3830-22-VIP            | 7311518041670 | 6   | 124 |
| 3830-24-C              | 7311518228378 | 1   | 124 |
| 3830-24-VIP            | 7311518041687 | 6   | 124 |



|             |               |   |     |
|-------------|---------------|---|-----|
| 3830-25-4P  | 7314150428663 | 1 | 124 |
| 3830-25-C   | 7311518225391 | 1 | 124 |
| 3830-25-VIP | 7311518041694 | 6 | 124 |
| 3830-27-4P  | 7314150428670 | 1 | 124 |
| 3830-27-C   | 7311518225407 | 1 | 124 |
| 3830-27-VIP | 7311518041700 | 6 | 124 |
| 3830-29-4P  | 7314150428922 | 1 | 124 |
| 3830-29-C   | 7311518225414 | 1 | 124 |
| 3830-29-VIP | 7311518041717 | 6 | 124 |
| 3830-30-4P  | 7314150433483 | 1 | 124 |
| 3830-30-C   | 7311518225421 | 1 | 124 |
| 3830-30-VIP | 7311518041724 | 6 | 124 |
| 3830-32-4P  | 7314150428687 | 1 | 124 |
| 3830-32-C   | 7311518225438 | 1 | 124 |
| 3830-32-VIP | 7311518041731 | 6 | 124 |
| 3830-33-C   | 7311518228385 | 1 | 124 |
| 3830-33-VIP | 7311518041748 | 6 | 124 |
| 3830-35-4P  | 7314150428700 | 1 | 124 |
| 3830-35-C   | 7311518225445 | 1 | 124 |
| 3830-35-VIP | 7311518041755 | 6 | 124 |
| 3830-37-C   | 7311518228392 | 1 | 124 |
| 3830-37-VIP | 7311518041762 | 6 | 124 |
| 3830-38-C   | 7311518225452 | 1 | 124 |
| 3830-38-VIP | 7311518041779 | 6 | 124 |
| 3830-40-C   | 7311518228408 | 1 | 124 |
| 3830-40-VIP | 7311518041786 | 6 | 124 |
| 3830-41-C   | 7311518225469 | 1 | 124 |
| 3830-41-VIP | 7311518041793 | 6 | 124 |
| 3830-43-C   | 7311518228415 | 1 | 124 |
| 3830-43-VIP | 7311518041809 | 6 | 124 |
| 3830-44-C   | 7311518225476 | 1 | 124 |
| 3830-44-VIP | 7311518041816 | 6 | 124 |
| 3830-46-C   | 7311518228422 | 1 | 124 |
| 3830-46-VIP | 7311518041823 | 6 | 124 |
| 3830-48-C   | 7311518225483 | 1 | 124 |
| 3830-48-VIP | 7311518041830 | 6 | 124 |
| 3830-50-C   | 7311518260873 | 1 | 124 |
| 3830-50-VIP | 7311518260866 | 6 | 124 |
| 3830-51-C   | 7311518225490 | 1 | 124 |
| 3830-51-VIP | 7311518041847 | 6 | 124 |
| 3830-52-C   | 7311518228439 | 1 | 124 |
| 3830-52-VIP | 7311518041854 | 4 | 124 |
| 3830-54-C   | 7311518225506 | 1 | 124 |
| 3830-54-VIP | 7311518041861 | 4 | 124 |
| 3830-55-C   | 7311518270919 | 1 | 124 |
| 3830-55-VIP | 7311518270902 | 4 | 124 |
| 3830-56-C   | 7311518228446 | 1 | 124 |
| 3830-56-VIP | 7311518152703 | 4 | 124 |
| 3830-57-C   | 7311518225513 | 1 | 124 |
| 3830-57-VIP | 7311518041878 | 4 | 124 |
| 3830-59-C   | 7311518228453 | 1 | 124 |
| 3830-59-VIP | 7311518041885 | 4 | 124 |
| 3830-60-C   | 7311518225520 | 1 | 124 |
| 3830-60-VIP | 7311518041892 | 4 | 124 |
| 3830-62-VIP | 7311518234645 | 4 | 124 |
| 3830-64-C   | 7311518225537 | 1 | 124 |
| 3830-64-VIP | 7311518041908 | 4 | 124 |
| 3830-65-C   | 7311518228460 | 1 | 124 |
| 3830-65-VIP | 7311518041915 | 4 | 124 |
| 3830-67-C   | 7311518225544 | 1 | 124 |
| 3830-67-VIP | 7311518041922 | 4 | 124 |
| 3830-68-C   | 7311518228477 | 1 | 124 |
| 3830-68-VIP | 7311518196530 | 4 | 124 |
| 3830-70-C   | 7311518225551 | 1 | 124 |
| 3830-70-VIP | 7311518041939 | 4 | 124 |
| 3830-73-C   | 7311518228484 | 1 | 124 |
| 3830-73-VIP | 7311518041946 | 4 | 124 |
| 3830-76-C   | 7311518225568 | 1 | 124 |
| 3830-76-VIP | 7311518041953 | 4 | 124 |
| 3830-79-C   | 7311518228491 | 1 | 124 |
| 3830-79-VIP | 7311518041960 | 4 | 124 |
| 3830-83-C   | 7311518225575 | 1 | 124 |
| 3830-83-VIP | 7311518041977 | 4 | 124 |
| 3830-86-C   | 7311518228507 | 1 | 124 |
| 3830-86-VIP | 7311518041984 | 4 | 124 |
| 3830-89-C   | 7311518225582 | 1 | 124 |
| 3830-89-VIP | 7311518041991 | 4 | 124 |
| 3830-92-C   | 7311518225599 | 1 | 124 |
| 3830-92-VIP | 7311518042004 | 4 | 124 |
| 3830-95-C   | 7311518225605 | 1 | 124 |
| 3830-95-VIP | 7311518042011 | 4 | 124 |
| 3830-98-C   | 7311518228514 | 1 | 124 |
| 3830-98-VIP | 7311518042028 | 4 | 124 |
| 3832-102    | 7311518558567 | 4 | 131 |
| 3832-102-C  | 7314150474394 | 1 | 132 |
| 3832-105    | 7311518558581 | 4 | 131 |
| 3832-108    | 7311518558604 | 4 | 131 |
| 3832-111    | 7311518558611 | 4 | 131 |
| 3832-114    | 7311518558628 | 4 | 131 |
| 3832-114-C  | 7314150474424 | 1 | 132 |
| 3832-121    | 7311518558642 | 1 | 131 |
| 3832-127    | 7311518558666 | 1 | 131 |
| 3832-127-C  | 7314150474431 | 1 | 132 |
| 3832-133    | 7311518558673 | 1 | 131 |
| 3832-14     | 7311518557744 | 6 | 131 |
| 3832-140    | 7311518558680 | 1 | 131 |

|                 |               |   |     |
|-----------------|---------------|---|-----|
| 3832-146        | 7311518558697 | 1 | 131 |
| 3832-152        | 7311518558703 | 1 | 131 |
| 3832-16         | 7311518557768 | 6 | 131 |
| 3832-16-C       | 7314150474448 | 1 | 132 |
| 3832-17         | 7311518557782 | 6 | 131 |
| 3832-19         | 7311518557805 | 6 | 131 |
| 3832-19-C       | 7314150474455 | 1 | 132 |
| 3832-20         | 7311518557812 | 6 | 131 |
| 3832-20-C       | 7314150474462 | 1 | 132 |
| 3832-21         | 7311518557829 | 6 | 131 |
| 3832-22         | 7311518557843 | 6 | 131 |
| 3832-22-C       | 7314150474479 | 1 | 132 |
| 3832-24         | 7311518557867 | 6 | 131 |
| 3832-24-C       | 7314150479054 | 1 | 132 |
| 3832-25         | 7311518557881 | 6 | 131 |
| 3832-25-C       | 7314150474486 | 1 | 132 |
| 3832-27         | 7311518557904 | 6 | 131 |
| 3832-29         | 7311518557928 | 6 | 131 |
| 3832-29-C       | 7314150474493 | 1 | 132 |
| 3832-30         | 7311518557942 | 6 | 131 |
| 3832-30-C       | 7314150479061 | 1 | 132 |
| 3832-32         | 7311518557966 | 6 | 131 |
| 3832-32-C       | 7314150474509 | 1 | 132 |
| 3832-33         | 7311518557980 | 6 | 131 |
| 3832-35         | 7311518558000 | 6 | 131 |
| 3832-35-C       | 7314150474516 | 1 | 132 |
| 3832-37         | 7311518558024 | 6 | 131 |
| 3832-38         | 7311518558048 | 6 | 131 |
| 3832-38-C       | 7314150474523 | 1 | 132 |
| 3832-40         | 7311518558062 | 6 | 131 |
| 3832-41         | 7311518558086 | 6 | 131 |
| 3832-41-C       | 7314150474530 | 1 | 132 |
| 3832-43         | 7311518558109 | 6 | 131 |
| 3832-44         | 7311518558123 | 6 | 131 |
| 3832-44-C       | 7314150474547 | 1 | 132 |
| 3832-46         | 7311518558147 | 6 | 131 |
| 3832-46-C       | 7314150479078 | 1 | 132 |
| 3832-48         | 7311518558161 | 6 | 131 |
| 3832-48-C       | 7314150474554 | 1 | 132 |
| 3832-51         | 7311518558185 | 6 | 131 |
| 3832-51-C       | 7314150474561 | 1 | 132 |
| 3832-52         | 7311518558208 | 4 | 131 |
| 3832-54         | 7311518558222 | 4 | 131 |
| 3832-54-C       | 7314150474578 | 1 | 132 |
| 3832-56         | 7311518558239 | 4 | 131 |
| 3832-57         | 7311518558246 | 4 | 131 |
| 3832-57-C       | 7314150474585 | 1 | 132 |
| 3832-59         | 7311518558260 | 4 | 131 |
| 3832-60         | 7311518558284 | 4 | 131 |
| 3832-60-C       | 7314150474615 | 1 | 132 |
| 3832-64         | 7311518558307 | 4 | 131 |
| 3832-64-C       | 7314150474622 | 1 | 132 |
| 3832-65         | 7311518558321 | 4 | 131 |
| 3832-67         | 7311518558345 | 4 | 131 |
| 3832-68         | 7311518558352 | 4 | 131 |
| 3832-70         | 7311518558369 | 4 | 131 |
| 3832-73         | 7311518558383 | 4 | 131 |
| 3832-73-C       | 7314150474639 | 1 | 132 |
| 3832-76         | 7311518558406 | 4 | 131 |
| 3832-76-C       | 7314150474646 | 1 | 132 |
| 3832-79         | 7311518558420 | 4 | 131 |
| 3832-83         | 7311518558444 | 4 | 131 |
| 3832-83-C       | 7314150474653 | 1 | 132 |
| 3832-86         | 7311518558468 | 4 | 131 |
| 3832-86-C       | 7314150474660 | 1 | 132 |
| 3832-89         | 7311518558482 | 4 | 131 |
| 3832-92         | 7311518558505 | 4 | 131 |
| 3832-92-C       | 7314150474677 | 1 | 132 |
| 3832-95         | 7311518558529 | 4 | 131 |
| 3832-98         | 7311518558543 | 4 | 131 |
| 3832-SET-164-ES | 7314150487349 | 1 | 132 |
| 3832-SET-84-ES  | 7314150498932 | 1 | 132 |
| 3833-102-C      | 7314150263899 | 1 | 129 |
| 3833-105-C      | 7314150263905 | 1 | 129 |
| 3833-108-C      | 7314150263912 | 1 | 129 |
| 3833-109-C      | 7314150263929 | 1 | 129 |
| 3833-111-C      | 7314150263936 | 1 | 129 |
| 3833-114-C      | 7314150263943 | 1 | 129 |
| 3833-121-C      | 7314150263950 | 1 | 129 |
| 3833-127-C      | 7314150263967 | 1 | 129 |
| 3833-133-C      | 7314150401581 | 1 | 129 |
| 3833-140-C      | 7314150263974 | 1 | 129 |
| 3833-152-C      | 7314150263981 | 1 | 129 |
| 3833-159-C      | 7314150263998 | 1 | 129 |
| 3833-168        | 7314150413546 | 1 | 129 |
| 3833-177        | 7314150413539 | 1 | 129 |
| 3833-19-C       | 7314150263561 | 1 | 129 |
| 3833-20-C       | 7314150263578 | 1 | 129 |
| 3833-210        | 7314150413522 | 1 | 129 |
| 3833-22-C       | 7314150263585 | 1 | 129 |
| 3833-225        | 7314150413515 | 1 | 129 |
| 3833-25-C       | 7314150263592 | 1 | 129 |
| 3833-27-C       | 7314150263608 | 1 | 129 |
| 3833-29-C       | 7314150263615 | 1 | 129 |
| 3833-30-C       | 7314150263622 | 1 | 129 |
| 3833-32-C       | 7314150263639 | 1 | 129 |

|                     |               |   |     |
|---------------------|---------------|---|-----|
| 3833-35-C           | 7314150263646 | 1 | 129 |
| 3833-38-C           | 7314150263653 | 1 | 129 |
| 3833-40-C           | 7314150263660 | 1 | 129 |
| 3833-41-C           | 7314150263677 | 1 | 129 |
| 3833-44-C           | 7314150263684 | 1 | 129 |
| 3833-48-C           | 7314150263691 | 1 | 129 |
| 3833-51-C           | 7314150263707 | 1 | 129 |
| 3833-54-C           | 7314150263714 | 1 | 129 |
| 3833-56-C           | 7314150314676 | 1 | 129 |
| 3833-57-C           | 7314150263721 | 1 | 129 |
| 3833-60-C           | 7314150263738 | 1 | 129 |
| 3833-62-C           | 7314150314683 | 1 | 129 |
| 3833-64-C           | 7314150263745 | 1 | 129 |
| 3833-65-C           | 7314150263752 | 1 | 129 |
| 3833-67-C           | 7314150263769 | 1 | 129 |
| 3833-68-C           | 7314150263776 | 1 | 129 |
| 3833-70-C           | 7314150263783 | 1 | 129 |
| 3833-71-C           | 7314150314690 | 1 | 129 |
| 3833-73-C           | 7314150263790 | 1 | 129 |
| 3833-74-C           | 7314150314706 | 1 | 129 |
| 3833-76-C           | 7314150263806 | 1 | 129 |
| 3833-77-C           | 7314150263813 | 1 | 129 |
| 3833-78-C           | 7314150314713 | 1 | 129 |
| 3833-79-C           | 7314150263820 | 1 | 129 |
| 3833-83-C           | 7314150263837 | 1 | 129 |
| 3833-86-C           | 7314150263844 | 1 | 129 |
| 3833-89-C           | 7314150263851 | 1 | 129 |
| 3833-92-C           | 7314150263868 | 1 | 129 |
| 3833-95-C           | 7314150263875 | 1 | 129 |
| 3833-98-C           | 7314150263882 | 1 | 129 |
| 3833-PROMO-42       | 7314150464951 | 1 | 129 |
| 3833-SET-101        | 7314150315383 | 1 | 129 |
| 3833-SET-201        | 7314150315406 | 1 | 129 |
| 3833-SET-202        | 7314150315420 | 1 | 129 |
| 3833-SET-203        | 7314150315444 | 1 | 130 |
| 3833-SET-204        | 7314150315468 | 1 | 130 |
| 3833-SET-205        | 7314150330874 | 1 | 130 |
| 3833-SET-207        | 7314150330898 | 1 | 130 |
| 3833-SET-208        | 7314150330904 | 1 | 130 |
| 3833-SET-301        | 7314150315376 | 1 | 130 |
| 3833-SET-302        | 7314150315390 | 1 | 131 |
| 3833-SET-303        | 7314150315413 | 1 | 131 |
| 3833-SET-304        | 7314150315437 | 1 | 131 |
| 3834-ADP            | 7311518454425 | 1 | 134 |
| 3834-ARBR-11152     | 7311518015596 | 1 | 133 |
| 3834-ARBR-11152-C   | 7311518225698 | 1 | 133 |
| 3834-ARBR-11152QC   | 7311518167967 | 1 | 133 |
| 3834-ARBR-11152QC-C | 7311518225711 | 1 | 133 |
| 3834-ARBR-1130      | 7311518015572 | 4 | 133 |
| 3834-ARBR-1130-C    | 7311518228583 | 1 | 133 |
| 3834-ARBR-16152     | 7311518015602 | 1 | 133 |
| 3834-ARBR-16152QC   | 7311518453152 | 1 | 133 |
| 3834-ARBR-630       | 7311518015558 | 1 | 133 |
| 3834-ARBR-630-C     | 7311518228576 | 1 | 133 |
| 3834-ARBR-730       | 7311518167974 | 1 | 133 |
| 3834-ARBR-730-C     | 7311518225674 | 1 | 133 |
| 3834-ARBR-9100      | 7311518015589 | 1 | 133 |
| 3834-ARBR-9100-C    | 7311518228590 | 1 | 133 |
| 3834-ARBR-9100EL    | 7314150265077 | 1 | 132 |
| 3834-ARBR-9100ESM   | 7314150390458 | 1 | 132 |
| 3834-ARBR-9100QC    | 7311518249830 | 1 | 133 |
| 3834-ARBR-9100QC-C  | 7311518225704 | 1 | 133 |
| 3834-ARBR-930       | 7311518015565 | 1 | 133 |
| 3834-ARBR-930-C     | 7311518225681 | 1 | 133 |
| 3834-ARBR-930EL     | 7314150265053 | 1 | 132 |
| 3834-ARBR-930ESM    | 7314150390465 | 1 | 132 |
| 3834-ARBR-SD152QC   | 7311518203825 | 1 | 133 |
| 3834-ARBR-SD30      | 7311518203818 | 1 | 133 |
| 3834-CP-20/25       | 7314150312092 | 1 | 124 |
| 3834-DRL            | 7311518234638 | 1 | 133 |
| 3834-DRL-CT         | 7311518953201 | 1 | 133 |
| 3834-DRL-EL         | 7314150265114 | 1 | 132 |
| 3834-DRL-ES         | 7314150265091 | 1 | 133 |
| 3834-DRL-HSS-ES     | 7314150339396 | 1 | 133 |
| 3834-DRL-L          | 7314150265138 | 1 | 133 |
| 3834-ES             | 7311518454418 | 1 | 133 |
| 3834-EXT-1          | 7311518040673 | 1 | 133 |
| 3834-EXT-2          | 7311518168070 | 1 | 133 |
| 3834-M6X29-SET      | 7314150383450 | 1 | 134 |
| 3834-M8X10-SET      | 7314150383429 | 1 | 134 |
| 3834-M8X5-SET       | 7314150383443 | 1 | 134 |
| 3834-M8X6-SET       | 7314150383436 | 1 | 134 |
| 3834-PROMO-122      | 7314150432059 | 1 | 125 |
| 3834-PROMO-122-76   | 7314150459193 | 1 | 125 |
| 3834-PROMO-82       | 7314150432042 | 1 | 125 |
| 3834-SET-103        | 7314150134908 | 1 | 128 |
| 3834-SET-152        | 7314150255658 | 1 | 128 |
| 3834-SET-42         | 7311518241988 | 1 | 125 |
| 3834-SET-53         | 7314150127153 | 1 | 125 |
| 3834-SET-61         | 7311518266431 | 1 | 126 |
| 3834-SET-62         | 7311518228040 | 1 | 126 |
| 3834-SET-62-16/50   | 7311518258887 | 1 | 126 |
| 3834-SET-65-16/51   | 7311518159900 | 1 | 126 |
| 3834-SET-65-22/64   | 7311518159917 | 1 | 126 |
| 3834-SET-72         | 7311518044992 | 1 | 126 |
| 3834-SET-72-35/83   | 7314150444229 | 1 | 125 |





# 3834-SET-73



|                   |               |   |     |
|-------------------|---------------|---|-----|
| 3834-SET-73       | 7311518254339 | 1 | 127 |
| 3834-SET-73-22/68 | 7314150134809 | 1 | 127 |
| 3834-SET-77       | 7314150235919 | 1 | 127 |
| 3834-SET-84-ES    | 7314150470587 | 1 | 127 |
| 3834-SET-86       | 7311518224295 | 1 | 127 |
| 3834-SET-87       | 7311518181772 | 1 | 127 |
| 3834-SET-92       | 7311518044985 | 1 | 128 |
| 3834-SET-93       | 7314150414741 | 1 | 128 |
| 3834-SET-94       | 7311518166458 | 1 | 128 |
| 3834-SET-95       | 7311518159894 | 1 | 128 |
| 3834-UPSIZE       | 7314150344567 | 1 | 133 |
| 3835-SET-64       | 7314150423309 | 1 | 132 |
| 3835-SET-711      | 7314150465835 | 1 | 132 |
| 384-5T            | 7311518159795 | 4 | 630 |
| 384-6T            | 7311518002039 | 4 | 630 |
| 3845-18-10P       | 7311518101602 | 1 | 135 |
| 3845-24-10P       | 7311518101619 | 1 | 135 |
| 3845-32-10P       | 7311518101626 | 1 | 135 |
| 385-6T            | 7311518002053 | 4 | 630 |
| 3851-10-0.6-10/14 | 7311518182717 | 1 | 12  |
| 3851-10-0.6-H-4   | 7311518282776 | 1 | 12  |
| 3851-10-0.6-H-6   | 7311518282806 | 1 | 12  |
| 3851-10-0.6-HA-4  | 7314150139309 | 1 | 12  |
| 3851-10-0.9-10/14 | 7311518182823 | 1 | 12  |
| 3851-10-0.9-H-4   | 7311518282851 | 1 | 12  |
| 3851-10-0.9-H-6   | 7311518282868 | 1 | 12  |
| 3851-10-0.9-R-14  | 7314150312399 | 1 | 12  |
| 3851-13-0.5-10/14 | 7311518282813 | 1 | 12  |
| 3851-13-0.5-14/18 | 7311518282790 | 1 | 12  |
| 3851-13-0.5-H-4   | 7311518292072 | 1 | 12  |
| 3851-13-0.5-R-10  | 7311518331306 | 1 | 12  |
| 3851-13-0.5-R-14  | 7311518331320 | 1 | 12  |
| 3851-13-0.5-R-18  | 7311518331344 | 1 | 12  |
| 3851-13-0.5-R-24  | 7311518282820 | 1 | 12  |
| 3851-13-0.6-10/14 | 7311518183271 | 1 | 12  |
| 3851-13-0.6-5/8   | 7311518183233 | 1 | 12  |
| 3851-13-0.6-6/10  | 7311518183240 | 1 | 12  |
| 3851-13-0.6-8/12  | 7311518185572 | 1 | 12  |
| 3851-13-0.6-H-3   | 7311518282769 | 1 | 12  |
| 3851-13-0.6-H-4   | 7311518282745 | 1 | 12  |
| 3851-13-0.6-H-6   | 7311518282738 | 1 | 12  |
| 3851-13-0.6-HA-4  | 7311518282752 | 1 | 12  |
| 3851-13-0.6-HA-6  | 7311518282561 | 1 | 12  |
| 3851-13-0.6-R-10  | 7311518183110 | 1 | 12  |
| 3851-13-0.6-R-14  | 7311518183158 | 1 | 12  |
| 3851-13-0.6-R-18  | 7311518183196 | 1 | 12  |
| 3851-13-0.9-10/14 | 7311518183868 | 1 | 12  |
| 3851-13-0.9-6/10  | 7311518183585 | 1 | 12  |
| 3851-13-0.9-H-3   | 7311518282936 | 1 | 12  |
| 3851-13-0.9-H-4   | 7311518282943 | 1 | 12  |
| 3851-13-0.9-H-6   | 7311518286125 | 1 | 12  |
| 3851-13-0.9-HA-4  | 7311518281052 | 1 | 12  |
| 3851-13-0.9-R-14  | 7311518182359 | 1 | 12  |
| 3851-13-0.9-R-6   | 7311518183301 | 1 | 12  |
| 3851-20-0.9-10/14 | 7311518282585 | 1 | 12  |
| 3851-20-0.9-4/6   | 7311518183905 | 1 | 12  |
| 3851-20-0.9-5/8   | 7311518183929 | 1 | 12  |
| 3851-20-0.9-6/10  | 7311518183936 | 1 | 12  |
| 3851-20-0.9-8/12  | 7311518282578 | 1 | 12  |
| 3851-20-0.9-H-3   | 7314150398515 | 1 | 12  |
| 3851-20-0.9-H-4   | 7314150398294 | 1 | 12  |
| 3851-20-0.9-HA-3  | 7311518282646 | 1 | 12  |
| 3851-20-0.9-HA-4  | 7311518282653 | 1 | 12  |
| 3851-20-0.9-R-18  | 7311518332587 | 1 | 12  |
| 3851-27-0.9-10/14 | 7311518165475 | 1 | 13  |
| 3851-27-0.9-2/3   | 7311518126377 | 1 | 13  |
| 3851-27-0.9-3/4   | 7311518126384 | 1 | 13  |
| 3851-27-0.9-4/6   | 7311518126391 | 1 | 13  |
| 3851-27-0.9-5/8   | 7311518126407 | 1 | 13  |
| 3851-27-0.9-6/10  | 7311518126414 | 1 | 13  |
| 3851-27-0.9-8/12  | 7311518160692 | 1 | 13  |
| 3851-27-0.9-HA-3  | 7311518282684 | 1 | 12  |
| 3851-27-0.9-HA-4  | 7314150398317 | 1 | 12  |
| 3851-27-0.9-P-3   | 7311518157135 | 1 | 12  |
| 3851-27-0.9-P-4   | 7311518157661 | 1 | 12  |
| 3851-27-0.9-R-6   | 7311518126353 | 1 | 12  |
| 3851-34-1.1-2/3   | 7311518126476 | 1 | 13  |
| 3851-34-1.1-3/4   | 7311518126483 | 1 | 13  |
| 3851-34-1.1-4/6   | 7311518126490 | 1 | 13  |
| 3851-34-1.1-5/8   | 7311518126506 | 1 | 13  |
| 3851-34-1.1-6/10  | 7311518165505 | 1 | 13  |
| 3851-34-1.1-P-2   | 7311518157715 | 1 | 12  |
| 3851-34-1.1-P-3   | 7311518157753 | 1 | 12  |
| 3851-41-1.3-1.4/2 | 7311518211837 | 1 | 13  |
| 3851-41-1.3-2/3   | 7311518126568 | 1 | 13  |
| 3851-41-1.3-3/4   | 7311518126575 | 1 | 13  |
| 3851-41-1.3-4/6   | 7311518126582 | 1 | 13  |
| 3851-41-1.3-5/8   | 7311518262488 | 1 | 13  |
| 3851-54-1.3-1.4/2 | 7314150459360 | 1 | 13  |
| 3851-54-1.3-2/3   | 7311518163716 | 1 | 13  |
| 3851-54-1.3-3/4   | 7311518163723 | 1 | 13  |
| 3851-54-1.3-4/6   | 7311518168025 | 1 | 13  |
| 3851-54-1.6-1.4/2 | 7311518211431 | 1 | 13  |
| 3851-54-1.6-1/1.4 | 7311518188542 | 1 | 13  |
| 3851-54-1.6-2/3   | 7311518126636 | 1 | 13  |
| 3851-54-1.6-3/4   | 7311518126643 | 1 | 13  |



|                       |               |   |    |
|-----------------------|---------------|---|----|
| 3851-54-1.6-4/6       | 7314150398539 | 1 | 13 |
| 3851-54-1.6-P-1.25    | 7311518158026 | 1 | 13 |
| 3851-6-0.6-10/14      | 7311518180652 | 1 | 12 |
| 3851-6-0.6-H-6        | 7311518282707 | 1 | 12 |
| 3851-6-0.9-10/14      | 7311518180768 | 1 | 12 |
| 3851-6-0.9-H-6        | 7311518282714 | 1 | 12 |
| 3851-67-1.6-7/1       | 7311518200909 | 1 | 13 |
| 3851-67-1.6-1.4/2     | 7314150273317 | 1 | 13 |
| 3851-67-1.6-1/1.4     | 7311518178840 | 1 | 13 |
| 3851-67-1.6-2/3       | 7311518335243 | 1 | 13 |
| 3851-67-1.6-3/4       | 7311518328597 | 1 | 13 |
| 3851-67-1.6-4/6       | 7311518194963 | 1 | 13 |
| 3851-80-1.6-7/1       | 7311518255367 | 1 | 13 |
| 3851-80-1.6-1.4/2     | 7311518255350 | 1 | 13 |
| 3851-80-1.6-1/1.4     | 7311518197377 | 1 | 13 |
| 3852-27-0.9-INS-3     | 7311518358204 | 1 | 17 |
| 3852-34-1.1-INS-3     | 7311518359188 | 1 | 17 |
| 3853-20-0.9-5/7-VS    | 7311518331689 | 1 | 14 |
| 3853-20-0.9-8/11-VS   | 7311518331702 | 1 | 14 |
| 3853-27-0.9-3/4       | 7311518285395 | 1 | 14 |
| 3853-27-0.9-4/6       | 7311518183998 | 1 | 14 |
| 3853-27-0.9-5/7-VS    | 7311518331115 | 1 | 14 |
| 3853-27-0.9-5/8       | 7311518202118 | 1 | 14 |
| 3853-27-0.9-8/11-VS   | 7311518331122 | 1 | 14 |
| 3853-34-1.1-2/3       | 7311518282875 | 1 | 14 |
| 3853-34-1.1-3/4       | 7311518184094 | 1 | 14 |
| 3853-34-1.1-4/6       | 7311518184087 | 1 | 14 |
| 3853-34-1.1-5/7-VS    | 7311518331726 | 1 | 14 |
| 3853-34-1.1-5/8       | 7311518202149 | 1 | 14 |
| 3853-34-1.1-8/11-VS   | 7311518331719 | 1 | 14 |
| 3853-41-1.3-2/3       | 7311518282882 | 1 | 14 |
| 3853-41-1.3-2/3-W     | 7314150370115 | 1 | 14 |
| 3853-41-1.3-2/3-WS    | 7314150415113 | 1 | 14 |
| 3853-41-1.3-3/4       | 7311518185770 | 1 | 14 |
| 3853-41-1.3-3/4-W     | 7311518338053 | 1 | 14 |
| 3853-41-1.3-3/4-WS    | 7314150415120 | 1 | 14 |
| 3853-41-1.3-4/6       | 7311518184100 | 1 | 14 |
| 3853-41-1.3-5/7-VS    | 7311518331733 | 1 | 14 |
| 3853-41-1.3-5/8       | 7311518202286 | 1 | 14 |
| 3853-54-1.3-3/4       | 7311518184124 | 1 | 14 |
| 3853-54-1.3-3/4-W     | 7314150352876 | 1 | 14 |
| 3853-54-1.3-5/8       | 7311518197568 | 1 | 14 |
| 3853-54-1.6-2/3       | 7311518282899 | 1 | 14 |
| 3853-54-1.6-2/3-W     | 7311518338077 | 1 | 14 |
| 3853-54-1.6-2/3-WS    | 7314150415151 | 1 | 14 |
| 3853-54-1.6-3/4       | 7311518216757 | 1 | 14 |
| 3853-54-1.6-3/4-W     | 7311518338091 | 1 | 14 |
| 3853-54-1.6-3/4-WS    | 7314150415168 | 1 | 14 |
| 3853-54-1.6-4/6       | 7311518222055 | 1 | 14 |
| 3853-67-1.6-2/3       | 7311518282905 | 1 | 14 |
| 3853-67-1.6-2/3-W     | 7311518338114 | 1 | 14 |
| 3853-67-1.6-2/3-WS    | 7314150415175 | 1 | 14 |
| 3853-67-1.6-3/4       | 7311518282912 | 1 | 14 |
| 3853-67-1.6-3/4-W     | 7311518338138 | 1 | 14 |
| 3853-67-1.6-3/4-WS    | 7314150415182 | 1 | 14 |
| 3853-67-1.6-5/8-W     | 7311518338152 | 1 | 14 |
| 3854-27-0.9-PHX-2/3   | 7314150440603 | 1 | 13 |
| 3854-27-0.9-PHX-3/4   | 7314150440610 | 1 | 13 |
| 3854-27-0.9-PHX-4/6   | 7314150440627 | 1 | 13 |
| 3854-27-0.9-PQ-3/4    | 7314150137480 | 1 | 13 |
| 3854-27-0.9-PQ-4/6    | 7314150197828 | 1 | 13 |
| 3854-34-1.1-PHX-1.4/2 | 7314150440634 | 1 | 13 |
| 3854-34-1.1-PHX-2/3   | 7314150440641 | 1 | 13 |
| 3854-34-1.1-PHX-3/4   | 7314150440658 | 1 | 13 |
| 3854-34-1.1-PHX-4/6   | 7314150440665 | 1 | 13 |
| 3854-34-1.1-PQ-2/3    | 7311518287276 | 1 | 13 |
| 3854-34-1.1-PQ-3/4    | 7314150135813 | 1 | 13 |
| 3854-34-1.1-PQ-4/6    | 7314150197835 | 1 | 13 |
| 3854-41-1.3-PHX-1.4/2 | 7314150440672 | 1 | 13 |
| 3854-41-1.3-PHX-2/3   | 7314150440689 | 1 | 13 |
| 3854-41-1.3-PHX-3/4   | 7314150440696 | 1 | 13 |
| 3854-41-1.3-PHX-4/6   | 7314150440702 | 1 | 13 |
| 3854-41-1.3-PQ-1.4/2  | 7314150129355 | 1 | 13 |
| 3854-41-1.3-PQ-2/3    | 7311518280604 | 1 | 13 |
| 3854-41-1.3-PQ-3/4    | 7311518282950 | 1 | 13 |
| 3854-41-1.3-PQ-4/6    | 7314150197842 | 1 | 13 |
| 3854-54-1.3-PHX-1.4/2 | 7314150440719 | 1 | 13 |
| 3854-54-1.3-PHX-2/3   | 7314150440733 | 1 | 13 |
| 3854-54-1.3-PHX-3/4   | 7314150440740 | 1 | 13 |
| 3854-54-1.6-PHX-7/1   | 7314150440757 | 1 | 13 |
| 3854-54-1.6-PHX-1.4/2 | 7314150440771 | 1 | 13 |
| 3854-54-1.6-PHX-1/1.4 | 7314150440764 | 1 | 13 |
| 3854-54-1.6-PHX-2/3   | 7314150440788 | 1 | 13 |
| 3854-54-1.6-PHX-3/4   | 7314150440795 | 1 | 13 |
| 3854-54-1.6-PQ-9/1.2  | 7314150133857 | 1 | 13 |
| 3854-54-1.6-PQ-1.4/2  | 7314150127092 | 1 | 13 |
| 3854-54-1.6-PQ-2/3    | 7311518265137 | 1 | 13 |
| 3854-54-1.6-PQ-3/4    | 7311518282929 | 1 | 13 |
| 3854-54-1.6-PQ-4/6    | 7311518330637 | 1 | 13 |
| 3854-67-1.6-PHX-7/1   | 7314150440801 | 1 | 13 |
| 3854-67-1.6-PHX-1.4/2 | 7314150440825 | 1 | 13 |
| 3854-67-1.6-PHX-1/1.4 | 7314150440818 | 1 | 13 |
| 3854-67-1.6-PHX-2/3   | 7314150440832 | 1 | 13 |
| 3854-67-1.6-PQ-9/1.2  | 7314150133888 | 1 | 13 |
| 3854-67-1.6-PQ-1.4/2  | 7314150133901 | 1 | 13 |
| 3854-67-1.6-PQ-2/3    | 7311518290160 | 1 | 13 |



|                         |               |   |     |
|-------------------------|---------------|---|-----|
| 3854-80-1.6-PHX-7/1     | 7314150440849 | 1 | 13  |
| 3854-80-1.6-PHX-1.4/2   | 7314150440863 | 1 | 13  |
| 3854-80-1.6-PHX-1/1.4   | 7314150440856 | 1 | 13  |
| 3854-80-1.6-PQ-9/1.2    | 7314150133895 | 1 | 13  |
| 3854-80-1.6-PQ-1.4/2    | 7314150215966 | 1 | 13  |
| 3857-13-0.6-EZ-L        | 7311518264789 | 1 | 12  |
| 3857-13-0.6-EZ-M        | 7311518264772 | 1 | 12  |
| 3857-13-0.6-EZ-M-3P1140 | 7314150321100 | 1 | 143 |
| 3857-13-0.6-EZ-M-3P690  | 7314150325641 | 1 | 143 |
| 3857-13-0.6-EZ-M-3P730  | 7314150325658 | 1 | 143 |
| 3857-13-0.6-EZ-M-3P835  | 7314150325665 | 1 | 143 |
| 3857-13-0.6-EZ-M-3P900  | 7314150321094 | 1 | 143 |
| 3857-13-0.6-EZ-S        | 7311518264765 | 1 | 12  |
| 3857-13-0.6-EZ-S-3P1140 | 7314150345731 | 1 | 143 |
| 3857-13-0.6-EZ-S-3P690  | 7314150345694 | 1 | 143 |
| 3857-13-0.6-EZ-S-3P730  | 7314150345700 | 1 | 143 |
| 3857-13-0.6-EZ-S-3P835  | 7314150345717 | 1 | 143 |
| 3857-13-0.6-EZ-S-3P900  | 7314150345724 | 1 | 143 |
| 3857-20-0.9-EZ-L        | 7311518264819 | 1 | 12  |
| 3857-20-0.9-EZ-M        | 7311518264802 | 1 | 12  |
| 3857-20-0.9-EZ-S        | 7311518264796 | 1 | 12  |
| 3857-27-0.9-EZ-L        | 7311518264840 | 1 | 12  |
| 3857-27-0.9-EZ-M        | 7311518264833 | 1 | 12  |
| 3857-27-0.9-EZ-S        | 7311518264826 | 1 | 12  |
| 3857-34-1.1-EZ-L        | 7311518264871 | 1 | 12  |
| 3857-34-1.1-EZ-M        | 7311518264864 | 1 | 12  |
| 3857-34-1.1-EZ-S        | 7311518264857 | 1 | 12  |
| 3858-34-1.1-PHX-1.4/2   | 7314150441198 | 1 | 14  |
| 3858-34-1.1-PHX-2/3     | 7314150441204 | 1 | 14  |
| 3858-34-1.1-PHX-3/4     | 7314150441211 | 1 | 14  |
| 3858-41-1.3-PHX-1.4/2   | 7314150441013 | 1 | 14  |
| 3858-41-1.3-PHX-2/3     | 7314150441020 | 1 | 14  |
| 3858-41-1.3-PHX-3/4     | 7314150441037 | 1 | 14  |
| 3858-41-1.3-PQ-1.4/2    | 7314150395583 | 1 | 14  |
| 3858-41-1.3-PQ-2/3      | 7314150395590 | 1 | 14  |
| 3858-41-1.3-PQ-3/4      | 7314150395606 | 1 | 14  |
| 3858-54-1.3-PHX-1.4/2   | 7314150441068 | 1 | 14  |
| 3858-54-1.3-PHX-2/3     | 7314150441044 | 1 | 14  |
| 3858-54-1.3-PHX-3/4     | 7314150441051 | 1 | 14  |
| 3858-54-1.6-PHX-7/1     | 7314150441075 | 1 | 14  |
| 3858-54-1.6-PHX-1.4/2   | 7314150441099 | 1 | 14  |
| 3858-54-1.6-PHX-1/1.4   | 7314150441082 | 1 | 14  |
| 3858-54-1.6-PHX-2/3     | 7314150441105 | 1 | 14  |
| 3858-54-1.6-PHX-3/4     | 7314150441112 | 1 | 14  |
| 3858-54-1.6-PQ-9/1.2    | 7314150395613 | 1 | 14  |
| 3858-54-1.6-PQ-1.4/2    | 7314150395620 | 1 | 14  |
| 3858-54-1.6-PQ-2/3      | 7314150395637 | 1 | 14  |
| 3858-67-1.6-PHX-7/1     | 7314150441129 | 1 | 14  |
| 3858-67-1.6-PHX-1.4/2   | 7314150441143 | 1 | 14  |
| 3858-67-1.6-PHX-1/1.4   | 7314150441136 | 1 | 14  |
| 3858-67-1.6-PHX-2/3     | 7314150441150 | 1 | 14  |
| 3858-67-1.6-PQ-9/1.2    | 7314150395644 | 1 | 14  |
| 3858-67-1.6-PQ-1.4/2    | 7314150395651 | 1 | 14  |
| 3858-80-1.6-PHX-7/1     | 7314150441167 | 1 | 14  |
| 3858-80-1.6-PHX-1.4/2   | 7314150441181 | 1 | 14  |
| 3858-80-1.6-PHX-1/1.4   | 7314150441174 | 1 | 14  |
| 3858-80-1.6-PQ-9/1.2    | 7314150395668 | 1 | 14  |
| 3859-27-0.9-EZX-3/4     | 7314150517558 | 1 | 15  |
| 3859-27-0.9-EZX-4/6     | 7314150517565 | 1 | 15  |
| 3859-34-1.1-EZX-2/3     | 7314150517572 | 1 | 15  |
| 3859-34-1.1-EZX-3/4     | 7314150517589 | 1 | 15  |
| 3859-34-1.1-EZX-4/6     | 7314150517596 | 1 | 15  |
| 3859-41-1.3-EZX-1.4/2   | 7314150517602 | 1 | 15  |
| 3859-41-1.3-EZX-2/3     | 7314150517619 | 1 | 15  |
| 3859-41-1.3-EZX-3/4     | 7314150517626 | 1 | 15  |
| 3859-41-1.3-EZX-4/6     | 7314150517633 | 1 | 15  |
| 3859-54-1.6-EZX-1.4/2   | 7314150517640 | 1 | 15  |
| 3859-54-1.6-EZX-1/1.25  | 7314150517657 | 1 | 15  |
| 3859-54-1.6-EZX-2/3     | 7314150517664 | 1 | 15  |
| 3859-54-1.6-EZX-3/4     | 7314150517671 | 1 | 15  |
| 3859-54-1.6-EZX-4/6     | 7314150517688 | 1 | 15  |
| 3859-67-1.6-EZX-7/1     | 7314150517695 | 1 | 15  |
| 3859-67-1.6-EZX-1.4/2   | 7314150517701 | 1 | 15  |
| 3859-67-1.6-EZX-1/1.25  | 7314150517718 | 1 | 15  |
| 3859-67-1.6-EZX-2/3     | 7314150517725 | 1 | 15  |
| 3859-80-1.6-EZX-7/1     | 7314150517732 | 1 | 15  |
| 3859-80-1.6-EZX-1.4/2   | 7314150517749 | 1 | 15  |
| 3859-80-1.6-EZX-1/1.25  | 7314150517756 | 1 | 15  |
| 386-6T                  | 7311518152017 | 4 | 630 |
| 3860-100-1.1-TMC-1.4/2  | 7314150336968 | 1 | 16  |
| 3860-27-0.9-TCZ-3       | 7314150413010 | 1 | 16  |
| 3860-27-0.9-TCZ-3/4     | 7314150413027 | 1 | 16  |
| 3860-27-0.9-TCZ-3/4     | 7314150263493 | 1 | 16  |
| 3860-34-1.1-TCZ-2/3     | 7314150413034 | 1 | 16  |
| 3860-34-1.1-TCZ-3/4     | 7314150413041 | 1 | 16  |
| 3860-34-1.1-TCZ-3/4-W   | 7314150413058 | 1 | 16  |
| 3860-34-1.1-TCZ-2/3     | 7311518330880 | 1 | 16  |
| 3860-34-1.1-TCZ-3/4     | 7311518330897 | 1 | 16  |
| 3860-41-1.3-TCZ-1.4/2   | 7314150413065 | 1 | 16  |
| 3860-41-1.3-TCZ-1.9/2.1 | 7314150413072 | 1 | 16  |
| 3860-41-1.3-TCZ-2/3     | 7314150413089 | 1 | 16  |
| 3860-41-1.3-TCZ-3/4     | 7314150413096 | 1 | 16  |
| 3860-41-1.3-TCZ-2/3     | 7311518330903 | 1 | 16  |
| 3860-41-1.3-TCZ-3/4     | 7311518330910 | 1 | 16  |
| 3860-41-1.3-TMC-1.4/2   | 7314150129379 | 1 | 16  |
| 3860-41-1.3-TMC-2/3     | 7311518330224 | 1 | 16  |



|                         |               |   |     |
|-------------------------|---------------|---|-----|
| 3860-54-1.3-TMC-1.4/2   | 7314150288748 | 1 | 16  |
| 3860-54-1.3-TMC-2/3     | 7311518335267 | 1 | 16  |
| 3860-54-1.6-TCZ-1.4/2   | 7314150413119 | 1 | 16  |
| 3860-54-1.6-TCZ-1.9/2.1 | 7314150413133 | 1 | 16  |
| 3860-54-1.6-TCZ-2/3     | 7314150413140 | 1 | 16  |
| 3860-54-1.6-TCZ-3/4     | 7314150413157 | 1 | 16  |
| 3860-54-1.6-TMC-7/1     | 7314150263431 | 1 | 16  |
| 3860-54-1.6-TMC-1.4/2   | 7314150137978 | 1 | 16  |
| 3860-54-1.6-TMC-1.4/2S  | 7314150395316 | 1 | 17  |
| 3860-54-1.6-TMC-1/1.25  | 7314150154340 | 1 | 16  |
| 3860-54-1.6-TMC-1/1.25S | 7314150395309 | 1 | 17  |
| 3860-54-1.6-TMC-2/3     | 7314150189366 | 1 | 16  |
| 3860-54-1.6-TMC-2/3S    | 7314150395323 | 1 | 17  |
| 3860-67-1.6-TCZ-1.4/2   | 7314150413164 | 1 | 16  |
| 3860-67-1.6-TCZ-1/1.25  | 7314150413171 | 1 | 16  |
| 3860-67-1.6-TMC-1.4/2   | 7314150137985 | 1 | 16  |
| 3860-67-1.6-TMC-1.4/2S  | 7314150395347 | 1 | 17  |
| 3860-67-1.6-TMC-1/1.25  | 7314150154364 | 1 | 16  |
| 3860-67-1.6-TMC-1/1.25S | 7314150395330 | 1 | 17  |
| 3860-67-1.6-TMC-2/3     | 7314150189359 | 1 | 16  |
| 3860-80-1.1-TMC-1.4/2   | 7314150382767 | 1 | 16  |
| 3860-80-1.6-TCZ-5/0.8   | 7314150413188 | 1 | 16  |
| 3860-80-1.6-TMC-7/1     | 7314150154371 | 1 | 16  |
| 3860-80-1.6-TMC-1.4/2   | 7314150182992 | 1 | 16  |
| 3860-80-1.6-TMC-1/1.25  | 7314150182336 | 1 | 16  |
| 3860-80-1.6-TMC-2/3     | 7314150215959 | 1 | 16  |
| 3861-20-0.6-H-4         | 7311518331351 | 1 | 17  |
| 3861-27-0.9-H-1.33      | 7311518329716 | 1 | 17  |
| 3861-34-0.9-H-1.15      | 7311518258894 | 1 | 17  |
| 3861-34-1.1-H-1.15      | 7311518258900 | 1 | 17  |
| 3861-41-1.1-H-1.15      | 7314150129294 | 1 | 17  |
| 3861-54-1.1-H-1.15      | 7314150129270 | 1 | 17  |
| 3862-33-0.9-H-1.15      | 7314150320325 | 1 | 17  |
| 3862-33-1.1-H-1.15      | 7311518331269 | 1 | 17  |
| 3862-40-1.1-H-1.15      | 7311518331283 | 1 | 17  |
| 3868-27-0.9-TSS-3/4     | 7314150447633 | 1 | 15  |
| 3868-27-0.9-TSS-3/4     | 7311518329693 | 1 | 15  |
| 3868-34-1.1-TSS-2/3     | 7311518329266 | 1 | 15  |
| 3868-34-1.1-TSS-3/4     | 7314150447640 | 1 | 15  |
| 3868-34-1.1-TSS-2       | 7311518203016 | 1 | 15  |
| 3868-34-1.1-TSS-2/3     | 7311518255343 | 1 | 15  |
| 3868-34-1.1-TSS-3/4     | 7311518232375 | 1 | 15  |
| 3868-41-1.3-TSS-1.4/2   | 7311518243142 | 1 | 15  |
| 3868-41-1.3-TSS-2/3     | 7311518270643 | 1 | 15  |
| 3868-41-1.3-TSS-1.4/2   | 7311518214210 | 1 | 15  |
| 3868-41-1.3-TSS-1.6     | 7311518203092 | 1 | 15  |
| 3868-41-1.3-TSS-2       | 7311518203085 | 1 | 15  |
| 3868-41-1.3-TSS-2/3     | 7311518232382 | 1 | 15  |
| 3868-41-1.3-TSS-3/4     | 7311518232399 | 1 | 15  |
| 3868-54-1.3-TSS-1.4/2   | 7311518214876 | 1 | 15  |
| 3868-54-1.3-TSS-2/3     | 7314150416394 | 1 | 15  |
| 3868-54-1.6-TSS-1.4/2   | 7311518243166 | 1 | 15  |
| 3868-54-1.6-TSS-1/1.25  | 7311518243173 | 1 | 15  |
| 3868-54-1.6-TSS-2/3     | 7311518280383 | 1 | 15  |
| 3868-54-1.6-TSS-1.4/2   | 7311518214869 | 1 | 15  |
| 3868-54-1.6-TSS-1.6     | 7311518203108 | 1 | 15  |
| 3868-54-1.6-TSS-1/1.25  | 7311518213114 | 1 | 15  |
| 3868-54-1.6-TSS-2/3     | 7311518232405 | 1 | 15  |
| 3868-54-1.6-TSS-3/4     | 7311518270360 | 1 | 15  |
| 3868-67-1.6-TSS-7/1     | 7311518274115 | 1 | 15  |
| 3868-67-1.6-TSS-1.4/2   | 7311518243197 | 1 | 15  |
| 3868-67-1.6-TSS-1/1.25  | 7311518243180 | 1 | 15  |
| 3868-67-1.6-TSS-2/3     | 7311518328825 | 1 | 15  |
| 3868-67-1.6-TSS-7/1     | 7311518212865 | 1 | 15  |
| 3868-67-1.6-TSS-1.4/2   | 7311518265496 | 1 | 15  |
| 3868-67-1.6-TSS-1/1.25  | 7311518213084 | 1 | 15  |
| 3868-67-1.6-TSS-2/3     | 7314150203536 | 1 | 15  |
| 3868-80-1.1-TSS-3/4     | 7311518330200 | 1 | 15  |
| 3868-80-1.6-TSS-7/1     | 7314150216253 | 1 | 15  |
| 3868-80-1.6-TSS-1.4/2   | 7314150203529 | 1 | 15  |
| 3868-80-1.6-TSS-2/3     | 7314150398553 | 1 | 15  |
| 3868-80-1.6-TSS-7/1     | 7311518212872 | 1 | 15  |
| 3868-80-1.6-TSS-1.4/2   | 7314150342167 | 1 | 15  |
| 3868-80-1.6-TSS-1/1.25  | 7314150277278 | 1 | 15  |
| 3868-80-1.6-TSS-2/3     | 7314150203543 | 1 | 15  |
| 3869-13-0.9-TS-3        | 7311518200589 | 1 | 15  |
| 3869-20-0.9-TS-3        | 7311518177300 | 1 | 15  |
| 3869-20-0.9-TS-4        | 7311518197742 | 1 | 15  |
| 3869-27-0.9-TS-3        | 7311518177348 | 1 | 15  |
| 3869-27-0.9-TS-4        | 7311518182595 | 1 | 15  |
| 3869-34-1.1-TS-2        | 7314150330508 | 1 | 15  |
| 3869-34-1.1-TS-3        | 7311518177355 | 1 | 15  |
| 3870-BRUSH-100-10       | 7311518269876 | 4 | 20  |
| 3870-BRUSH-100-10-HEX   | 7311518333935 | 4 | 20  |
| 3870-BRUSH-100-12       | 7311518269883 | 4 | 20  |
| 3870-BRUSH-100-13       | 7314150321131 | 4 | 20  |
| 3870-BRUSH-60-6         | 7311518279523 | 4 | 20  |
| 3870-BRUSH-80-10        | 7311518278311 | 4 | 20  |
| 3870-BRUSH-80-6         | 7311518269906 | 4 | 20  |
| 3870-BRUSH-80-8         | 7311518269890 | 4 | 20  |
| 3870-REFRACTOMETER      | 7311518192129 | 1 | 20  |
| 3870-TACHO METER        | 7311518145620 | 1 | 20  |
| 3870-TENSION METER      | 7311518145637 | 1 | 20  |
| 3870-WEDGE-3            | 7311518262747 | 1 | 20  |
| 3870-WHEEL              | 7314150398652 | 1 | 20  |
| 3875-BP2                | 7314150187744 | 8 | 474 |



# 3875-GLOVE



|                        |               |     |     |
|------------------------|---------------|-----|-----|
| 3875-GLOVE             | 7314150353330 | 5   | 490 |
| 3875-HB10              | 7314150349777 | 1   | 473 |
| 3875-HB100             | 7314150289783 | 1   | 474 |
| 3875-HB30              | 7314150187720 | 1   | 474 |
| 3875-HB60              | 7314150187713 | 6   | 474 |
| 3875-LY1               | 7314150191253 | 8   | 472 |
| 3875-LY10              | 7314150315062 | 1   | 473 |
| 3875-LY2               | 7314150191260 | 8   | 472 |
| 3875-LY3               | 7314150191284 | 8   | 472 |
| 3875-LY4               | 7314150262878 | 8   | 472 |
| 3875-LY60              | 7314150436521 | 1   | 472 |
| 3875-LY70              | 7314150442751 | 1   | 472 |
| 3875-LY8               | 7314150309689 | 1   | 473 |
| 3875-MHP6              | 7314150187812 | 1   | 474 |
| 3875-QL1               | 7314150191307 | 8   | 472 |
| 3875-QRL1              | 7314150194797 | 1   | 472 |
| 3875-RL1               | 7314150194780 | 1   | 472 |
| 3875-RL2               | 7314150312948 | 1   | 472 |
| 3875-SB70              | 7314150326839 | 1   | 474 |
| 3875-SL1               | 7314150220106 | 1   | 473 |
| 3875-WL1               | 7314150191291 | 8   | 472 |
| 3881-100-1.6-THS-7/1   | 7311518329617 | 1   | 16  |
| 3881-34-1.1-THQ-2/3    | 7311518265793 | 1   | 16  |
| 3881-41-1.3-THQ-1.4/2  | 7314150129447 | 1   | 16  |
| 3881-41-1.3-THQ-2/3    | 7314150129454 | 1   | 16  |
| 3881-41-1.3-THS-1.4/2  | 7311518273712 | 1   | 16  |
| 3881-54-1.6-THQ-1.4/2  | 7314150128860 | 1   | 16  |
| 3881-54-1.6-THQ-1/1.25 | 7314150342181 | 1   | 16  |
| 3881-54-1.6-THQ-2/3    | 7314150138739 | 1   | 16  |
| 3881-54-1.6-THS-1.4/2  | 7314150138784 | 1   | 16  |
| 3881-54-1.6-THS-1/1.25 | 7311518269050 | 1   | 16  |
| 3881-67-1.6-THQ-1.4/2  | 7314150120369 | 1   | 16  |
| 3881-67-1.6-THQ-1/1.25 | 7314150180097 | 1   | 16  |
| 3881-67-1.6-THQ-2/3    | 7311518328832 | 1   | 16  |
| 3881-67-1.6-THS-1.4/2  | 7314150138791 | 1   | 16  |
| 3881-67-1.6-THS-1/1.25 | 7311518269043 | 1   | 16  |
| 3881-67-1.6-THS-2/3    | 7311518328849 | 1   | 16  |
| 3881-80-1.6-THQ-7/1    | 7311518332938 | 1   | 16  |
| 3881-80-1.6-THQ-1.4/2  | 7311518328856 | 1   | 16  |
| 3881-80-1.6-THQ-1/1.25 | 7314150133918 | 1   | 16  |
| 3881-80-1.6-THQ-2/3    | 7311518328863 | 1   | 16  |
| 3881-80-1.6-THS-7/1    | 7311518279202 | 1   | 16  |
| 3881-80-1.6-THS-1.4/2  | 7314150195312 | 1   | 16  |
| 3881-80-1.6-THS-2/3    | 7314150215942 | 1   | 16  |
| 38A-08                 | 7314150433469 | 25  | 331 |
| 38A-10                 | 7314150431564 | 25  | 331 |
| 38A-12                 | 7314150237944 | 1   | 331 |
| 38A-15                 | 7314150237951 | 25  | 331 |
| 38A-21                 | 7314150237968 | 1   | 331 |
| 38A-26                 | 7314150237975 | 1   | 331 |
| 38C-26                 | 7314150237982 | 1   | 331 |
| 39-24                  | 7314151831301 | 1   | 331 |
| 3905-250-24-100        | 7311518299255 | 100 | 558 |
| 3905-300-14-100        | 7311518292201 | 100 | 558 |
| 3905-300-18-100        | 7311518292218 | 100 | 558 |
| 3905-300-24-100        | 7311518292225 | 100 | 558 |
| 3905-300-24-2P         | 7311518299248 | 10  | 558 |
| 3905-300-32-100        | 7311518292232 | 100 | 558 |
| 3906-250-18-100        | 7311518250997 | 100 | 557 |
| 3906-250-18-5P         | 7314150265534 | 10  | 557 |
| 3906-250-24-100        | 7311518251000 | 100 | 557 |
| 3906-250-24-5P         | 7314150265541 | 10  | 557 |
| 3906-250-32-100        | 7311518251017 | 100 | 557 |
| 3906-250-32-5P         | 7314150265558 | 10  | 557 |
| 3906-300-14-100        | 7311518233563 | 100 | 557 |
| 3906-300-14-10P        | 7311518233693 | 10  | 557 |
| 3906-300-14-5P         | 7314150265565 | 10  | 557 |
| 3906-300-18-100        | 7311518233570 | 100 | 557 |
| 3906-300-18-10P        | 7311518233723 | 10  | 557 |
| 3906-300-18-2P         | 7311518233617 | 10  | 557 |
| 3906-300-18-5P         | 7314150265572 | 10  | 557 |
| 3906-300-24-100        | 7311518233587 | 100 | 557 |
| 3906-300-24-10P        | 7311518233730 | 10  | 557 |
| 3906-300-24-2P         | 7311518233624 | 10  | 557 |
| 3906-300-24-5P         | 7311518237417 | 100 | 557 |
| 3906-300-32-100        | 7311518233594 | 100 | 557 |
| 3906-300-32-10P        | 7311518233747 | 10  | 557 |
| 3906-300-32-2P         | 7311518233631 | 10  | 557 |
| 3906-300-32-5P         | 7311518237424 | 10  | 557 |
| 3906-300-3P            | 7311518233754 | 10  | 557 |
| 3911-115-IM-10P        | 7314150485703 | 10  | 142 |
| 3911-115-T41-AL        | 7314150485642 | 25  | 142 |
| 3911-115-T41-I         | 7314150454570 | 25  | 142 |
| 3911-115-T41-IM        | 7314150454587 | 50  | 142 |
| 3911-115-T42-M         | 7314150454679 | 25  | 142 |
| 3911-115T41-IM         | 7314150460595 | 50  | 142 |
| 3911-125-IM-10P        | 7314150485680 | 10  | 142 |
| 3911-125-T41-AL        | 7314150485666 | 25  | 142 |
| 3911-125-T41-I         | 7314150454594 | 25  | 142 |
| 3911-125-T41-IM        | 7314150454600 | 50  | 142 |
| 3911-125-T42-M         | 7314150454686 | 25  | 142 |
| 3911-125T41-IM         | 7314150485444 | 25  | 142 |
| 3911-150-T41-I         | 7314150454624 | 50  | 142 |
| 3911-150-T42-M         | 7314150454709 | 25  | 142 |
| 3911-180-T41-I         | 7314150454631 | 50  | 142 |
| 3911-180-T41-IM        | 7314150454655 | 50  | 142 |



|                     |               |     |     |
|---------------------|---------------|-----|-----|
| 3911-180-T42-M      | 7314150454693 | 25  | 142 |
| 3911-180T41-IM      | 7314150485468 | 50  | 142 |
| 3911-230-T41-I      | 7314150454648 | 50  | 142 |
| 3911-230-T41-IM     | 7314150454662 | 50  | 142 |
| 3911-230-T42-M      | 7314150454716 | 50  | 142 |
| 3911-2301922XDT     | 7314150522439 | 50  | 142 |
| 3911-2301T41-IM     | 7314150485482 | 50  | 142 |
| 3911-2302522XDT     | 7314150522415 | 50  | 142 |
| 3911-2303T41-IM     | 7314150485628 | 50  | 142 |
| 3911-350-X2TM       | 7314150486366 | 35  | 142 |
| 3911-400-F2TM       | 7314150485963 | 15  | 142 |
| 3911-400-X2TM       | 7314150502967 | 15  | 142 |
| 3911-751010XTM      | 7314150522392 | 10  | 142 |
| 3912-115-T41-IM     | 7314150454808 | 25  | 142 |
| 3912-115-T42-ST     | 7314150454723 | 25  | 142 |
| 3912-125-T41-IM     | 7314150454815 | 25  | 142 |
| 3912-125-T42-ST     | 7314150454730 | 25  | 142 |
| 3912-180-T42-ST     | 7314150454747 | 25  | 142 |
| 3912-230-T42-ST     | 7314150454754 | 50  | 142 |
| 3916-115-10P-CE     | 7314150455348 | 100 | 143 |
| 3916-115-10S-UE     | 7314150455270 | 100 | 143 |
| 3916-125-10P-CE     | 7314150455355 | 100 | 143 |
| 3916-125-10S-UE     | 7314150455287 | 100 | 143 |
| 3916-150-10S-UE     | 7314150455294 | 50  | 143 |
| 3916-180-10S-UE     | 7314150455300 | 50  | 143 |
| 3916-230-10L-RC     | 7314150455232 | 25  | 143 |
| 3916-230-10S-UE     | 7314150455317 | 25  | 143 |
| 3917-115-7S-C       | 7314150455324 | 100 | 143 |
| 3917-115-7S-U       | 7314150455249 | 100 | 143 |
| 3917-125-7S-C       | 7314150455331 | 100 | 143 |
| 3917-125-7S-U       | 7314150455256 | 100 | 143 |
| 3917-230-7S-U       | 7314150455263 | 25  | 143 |
| 3921-115-T27-IM     | 7314150454617 | 25  | 142 |
| 3921-125-T27-IM     | 7314150454761 | 25  | 142 |
| 3921-150-T27-IM     | 7314150454778 | 25  | 142 |
| 3921-180-T27-IM     | 7314150454785 | 25  | 142 |
| 3921-230-T27-IM     | 7314150454792 | 25  | 142 |
| 3926-115IM-C120     | 7314150454860 | 20  | 143 |
| 3926-115IM-C40      | 7314150454839 | 20  | 143 |
| 3926-115IM-C60      | 7314150454846 | 20  | 143 |
| 3926-115IM-C80      | 7314150454853 | 20  | 143 |
| 3926-125IM-C120     | 7314150454914 | 20  | 143 |
| 3926-125IM-C40      | 7314150454884 | 20  | 143 |
| 3926-125IM-C60      | 7314150454891 | 20  | 143 |
| 3926-125IM-C80      | 7314150454907 | 20  | 143 |
| 3927-115IM-P120     | 7314150454952 | 20  | 143 |
| 3927-115IM-P40      | 7314150454921 | 20  | 143 |
| 3927-115IM-P60      | 7314150454938 | 20  | 143 |
| 3927-115IM-P80      | 7314150454945 | 20  | 143 |
| 3927-125-120-3P     | 7314150499007 | 12  | 143 |
| 3927-125-40-3P      | 7314150498949 | 12  | 143 |
| 3927-125-60-3P      | 7314150498963 | 12  | 143 |
| 3927-125-80-3P      | 7314150498987 | 12  | 143 |
| 3927-125IM-P120     | 7314150455010 | 20  | 143 |
| 3927-125IM-P40      | 7314150454976 | 20  | 143 |
| 3927-125IM-P60      | 7314150454983 | 20  | 143 |
| 3927-125IM-P80      | 7314150455003 | 20  | 143 |
| 3940-100-14-SC-2P   | 7314150364466 | 10  | 134 |
| 3940-100-14-SC-5P   | 7314150364473 | 5   | 134 |
| 3940-100-14-ST-10P  | 7314150364336 | 1   | 134 |
| 3940-100-14-ST-2P   | 7314150364312 | 10  | 134 |
| 3940-100-14-ST-5P   | 7314150364329 | 5   | 134 |
| 3940-100-18-SC-2P   | 7314150364442 | 10  | 134 |
| 3940-100-18-SC-5P   | 7314150364459 | 5   | 134 |
| 3940-100-18-ST-10P  | 7314150364367 | 1   | 134 |
| 3940-100-18-ST-2P   | 7314150364343 | 10  | 134 |
| 3940-100-18-ST-5P   | 7314150364350 | 5   | 134 |
| 3940-100-24-SC-2P   | 7314150364558 | 10  | 134 |
| 3940-100-24-SC-5P   | 7314150364565 | 5   | 134 |
| 3940-100-24-ST-10P  | 7314150364435 | 1   | 134 |
| 3940-100-24-ST-2P   | 7314150364411 | 10  | 134 |
| 3940-100-24-ST-5P   | 7314150364428 | 5   | 134 |
| 3940-150-10-HST-10P | 7314150364039 | 1   | 134 |
| 3940-150-10-HST-2P  | 7314150364015 | 10  | 134 |
| 3940-150-10-HST-5P  | 7314150364022 | 5   | 134 |
| 3940-150-10-ST-100P | 7314150362196 | 1   | 134 |
| 3940-150-10-ST-10P  | 7314150362189 | 1   | 134 |
| 3940-150-10-ST-2P   | 7314150362165 | 10  | 134 |
| 3940-150-10-ST-5P   | 7314150362172 | 5   | 134 |
| 3940-150-14-HST-10P | 7314150362370 | 1   | 134 |
| 3940-150-14-HST-2P  | 7314150362325 | 10  | 134 |
| 3940-150-14-HST-5P  | 7314150362363 | 5   | 134 |
| 3940-150-14-ST-100P | 7314150364183 | 1   | 134 |
| 3940-150-14-ST-10P  | 7314150364176 | 1   | 134 |
| 3940-150-14-ST-2P   | 7314150364152 | 5   | 134 |
| 3940-150-14-ST-5P   | 7314150364169 | 5   | 134 |
| 3940-150-18-HST-10P | 7314150364060 | 1   | 134 |
| 3940-150-18-HST-2P  | 7314150364046 | 10  | 134 |
| 3940-150-18-HST-5P  | 7314150364053 | 5   | 134 |
| 3940-150-18-ST-100P | 7314150364107 | 1   | 134 |
| 3940-150-18-ST-10P  | 7314150364091 | 1   | 134 |
| 3940-150-18-ST-2P   | 7314150364077 | 10  | 134 |
| 3940-150-18-ST-5P   | 7314150364084 | 5   | 134 |
| 3940-150-24-ST-100P | 7314150364404 | 1   | 134 |
| 3940-150-24-ST-10P  | 7314150364398 | 1   | 134 |
| 3940-150-24-ST-2P   | 7314150364374 | 5   | 134 |





|                          |               |    |     |
|--------------------------|---------------|----|-----|
| 3940-150-24-ST-5P        | 7314150364381 | 5  | 134 |
| 3940-150-4/6-SC-10P      | 7314150361847 | 1  | 135 |
| 3940-150-4/6-SC-2P       | 7314150361823 | 10 | 135 |
| 3940-150-4/6-SC-5P       | 7314150361830 | 5  | 135 |
| 3940-150-5/8-DSL-10P     | 7314150361991 | 1  | 135 |
| 3940-150-5/8-DSL-2P      | 7314150361977 | 5  | 135 |
| 3940-150-5/8-DSL-5P      | 7314150361984 | 5  | 135 |
| 3940-150-5/8-SL-100P     | 7314150361724 | 1  | 135 |
| 3940-150-5/8-SL-10P      | 7314150361717 | 1  | 135 |
| 3940-150-5/8-SL-2P       | 7314150361687 | 10 | 135 |
| 3940-150-5/8-SL-5P       | 7314150361700 | 5  | 135 |
| 3940-150-6-ST-10P        | 7314150361786 | 1  | 135 |
| 3940-150-6-ST-2P         | 7314150361762 | 10 | 135 |
| 3940-150-6-ST-5P         | 7314150361779 | 5  | 135 |
| 3940-150-8/12-ST-100P    | 7314150362158 | 1  | 134 |
| 3940-150-8/12-ST-10P     | 7314150362141 | 1  | 134 |
| 3940-150-8/12-ST-2P      | 7314150362127 | 10 | 134 |
| 3940-150-8/12-ST-5P      | 7314150362134 | 5  | 134 |
| 3940-228-10-DSL-100P     | 7314150362035 | 1  | 135 |
| 3940-228-10-DSL-10P      | 7314150362028 | 1  | 135 |
| 3940-228-10-DSL-2P       | 7314150362004 | 10 | 135 |
| 3940-228-10-DSL-5P       | 7314150362011 | 5  | 135 |
| 3940-228-10-HST-100P     | 7314150362417 | 1  | 134 |
| 3940-228-10-HST-10P      | 7314150362400 | 1  | 134 |
| 3940-228-10-HST-2P       | 7314150362387 | 10 | 134 |
| 3940-228-10-HST-5P       | 7314150362394 | 5  | 134 |
| 3940-228-10-PR09-100P    | 7314150361625 | 1  | 135 |
| 3940-228-10-ST-100P      | 7314150362110 | 1  | 134 |
| 3940-228-10-ST-10P       | 7314150362103 | 1  | 134 |
| 3940-228-10-ST-2P        | 7314150362080 | 10 | 134 |
| 3940-228-10-ST-5P        | 7314150362097 | 5  | 134 |
| 3940-228-10/14-PR09-100P | 7314150361526 | 1  | 135 |
| 3940-228-10/14-PR09-10P  | 7314150361519 | 1  | 135 |
| 3940-228-10/14-PR13-100P | 7314150361649 | 1  | 135 |
| 3940-228-10/14-PR13-10P  | 7314150451265 | 1  | 135 |
| 3940-228-14-HST-10P      | 7314150362226 | 1  | 134 |
| 3940-228-14-HST-2P       | 7314150362202 | 10 | 134 |
| 3940-228-14-HST-5P       | 7314150362219 | 5  | 134 |
| 3940-228-14-ST-100P      | 7314150364145 | 1  | 134 |
| 3940-228-14-ST-10P       | 7314150364138 | 1  | 134 |
| 3940-228-14-ST-2P        | 7314150364114 | 5  | 134 |
| 3940-228-14-ST-5P        | 7314150364121 | 5  | 134 |
| 3940-228-18-HST-10P      | 7314150362271 | 1  | 134 |
| 3940-228-18-HST-2P       | 7314150362233 | 10 | 134 |
| 3940-228-18-HST-5P       | 7314150362264 | 5  | 134 |
| 3940-228-18-ST-100P      | 7314150364220 | 1  | 134 |
| 3940-228-18-ST-10P       | 7314150364213 | 1  | 134 |
| 3940-228-18-ST-2P        | 7314150364190 | 10 | 134 |
| 3940-228-18-ST-5P        | 7314150364206 | 5  | 134 |
| 3940-228-5/8-DSL-10P     | 7314150361939 | 1  | 135 |
| 3940-228-5/8-DSL-2P      | 7314150361915 | 10 | 135 |
| 3940-228-5/8-DSL-5P      | 7314150361922 | 5  | 135 |
| 3940-228-6-SL-10P        | 7314150361755 | 1  | 135 |
| 3940-228-6-SL-2P         | 7314150361731 | 10 | 135 |
| 3940-228-6-SL-5P         | 7314150361748 | 5  | 135 |
| 3940-228-8/12-PR13-100P  | 7314150361601 | 1  | 135 |
| 3940-228-8/12-ST-100P    | 7314150362073 | 1  | 134 |
| 3940-228-8/12-ST-10P     | 7314150362066 | 1  | 134 |
| 3940-228-8/12-ST-2P      | 7314150362042 | 5  | 134 |
| 3940-228-8/12-ST-5P      | 7314150362059 | 5  | 134 |
| 3940-300-10-HST-10P      | 7314150362448 | 1  | 134 |
| 3940-300-10-HST-2P       | 7314150362424 | 10 | 134 |
| 3940-300-10-HST-5P       | 7314150362431 | 5  | 134 |
| 3940-300-14-HST-10P      | 7314150362301 | 1  | 134 |
| 3940-300-14-HST-2P       | 7314150362288 | 10 | 134 |
| 3940-300-14-HST-5P       | 7314150362295 | 5  | 134 |
| 3940-300-14-ST-100P      | 7314150364268 | 1  | 134 |
| 3940-300-14-ST-10P       | 7314150364251 | 1  | 134 |
| 3940-300-14-ST-2P        | 7314150364237 | 5  | 134 |
| 3940-300-14-ST-5P        | 7314150364244 | 5  | 134 |
| 3940-300-18-HST-10P      | 7314150364008 | 1  | 134 |
| 3940-300-18-HST-2P       | 7314150363988 | 10 | 134 |
| 3940-300-18-HST-5P       | 7314150363995 | 5  | 134 |
| 3940-300-18-ST-100P      | 7314150364305 | 1  | 134 |
| 3940-300-18-ST-10P       | 7314150364299 | 1  | 134 |
| 3940-300-18-ST-2P        | 7314150364275 | 10 | 134 |
| 3940-300-18-ST-5P        | 7314150364282 | 5  | 134 |
| 3940-300-5/8-DSL-10P     | 7314150361960 | 1  | 135 |
| 3940-300-5/8-DSL-2P      | 7314150361946 | 10 | 135 |
| 3940-300-5/8-DSL-5P      | 7314150361953 | 5  | 135 |
| 3940-300-6-SL-10P        | 7314150361816 | 1  | 135 |
| 3940-300-6-SL-2P         | 7314150361793 | 10 | 135 |
| 3940-300-6-SL-5P         | 7314150361809 | 5  | 135 |
| 3940-300-8/12-SL-100P    | 7314150361908 | 1  | 135 |
| 3940-300-8/12-SL-10P     | 7314150361892 | 1  | 135 |
| 3940-300-8/12-SL-2P      | 7314150361878 | 5  | 135 |
| 3940-300-8/12-SL-5P      | 7314150361885 | 5  | 135 |
| 3940-HDD-SET-5P          | 7314150401703 | 5  | 137 |
| 3940-METAL-SET-12P       | 7314150511488 | 6  | 137 |
| 3940-METAL-SET-5P        | 7314150401673 | 5  | 137 |
| 3940-MIX-SET-10P         | 7314150401666 | 4  | 137 |
| 3940-MIX-SET-12P         | 7314150511501 | 6  | 137 |
| 3940-MIX-SET-5P          | 7314150401659 | 5  | 137 |
| 3942-150-7-SL-10P        | 7314150364534 | 1  | 136 |
| 3942-150-7-SL-2P         | 7314150364510 | 10 | 136 |
| 3942-150-7-SL-5P         | 7314150364527 | 5  | 136 |



|                     |               |     |     |
|---------------------|---------------|-----|-----|
| 3942-228-11-HSL-10P | 7314150364831 | 1   | 136 |
| 3942-228-11-HSL-2P  | 7314150364817 | 10  | 136 |
| 3942-228-11-HSL-5P  | 7314150364824 | 5   | 136 |
| 3942-228-5-HSL-10P  | 7314150364657 | 1   | 136 |
| 3942-228-5-HSL-2P   | 7314150364633 | 10  | 136 |
| 3942-228-5-HSL-5P   | 7314150364640 | 5   | 136 |
| 3942-228-7-HSL-10P  | 7314150364749 | 1   | 136 |
| 3942-228-7-HSL-2P   | 7314150364725 | 10  | 136 |
| 3942-228-7-HSL-5P   | 7314150364732 | 5   | 136 |
| 3942-228-7-SL-10P   | 7314150364503 | 1   | 136 |
| 3942-228-7-SL-2P    | 7314150364480 | 10  | 136 |
| 3942-228-7-SL-5P    | 7314150364497 | 5   | 136 |
| 3942-300-5-HSL-10P  | 7314150364688 | 1   | 136 |
| 3942-300-5-HSL-2P   | 7314150364664 | 10  | 136 |
| 3942-300-5-HSL-5P   | 7314150364671 | 5   | 136 |
| 3942-300-7-HSL-10P  | 7314150364770 | 1   | 136 |
| 3942-300-7-HSL-2P   | 7314150364756 | 10  | 136 |
| 3942-300-7-HSL-5P   | 7314150364763 | 5   | 136 |
| 3942-300-7-SL-10P   | 7314150364619 | 1   | 136 |
| 3942-300-7-SL-2P    | 7314150364596 | 10  | 136 |
| 3942-300-7-SL-5P    | 7314150364602 | 5   | 136 |
| 3942-WOOD-SET-12P   | 7314150511525 | 6   | 137 |
| 3942-WOOD-SET-5P    | 7314150401680 | 5   | 137 |
| 3943-C30-JT-F       | 7314150422869 | 10  | 136 |
| 3943-C30-JT-M       | 7314150422876 | 10  | 136 |
| 3943-C35-JT-C       | 7314150422937 | 10  | 136 |
| 3943-C35-JT-M       | 7314150422883 | 10  | 136 |
| 3943-R28-UT-C-2P    | 7314150422951 | 10  | 137 |
| 3943-S20-JT-F       | 7314150422944 | 10  | 136 |
| 3944-300-3-MEAT-1P  | 7314150364862 | 10  | 138 |
| 3946-100-DG-ST-2P   | 7314150478644 | 10  | 135 |
| 3946-150-10-HST-1P  | 7314150478156 | 10  | 135 |
| 3946-150-6-DSL-1P   | 7314150478101 | 10  | 136 |
| 3946-150-6-SL-1P    | 7314150364916 | 5   | 138 |
| 3946-150-8-HST-1P   | 7314150478132 | 10  | 135 |
| 3946-150-DG-ST-2P   | 7314150478668 | 10  | 135 |
| 3946-228-10-HST-1P  | 7314150478255 | 10  | 135 |
| 3946-228-3-ST-1P    | 7314150364886 | 5   | 138 |
| 3946-228-6-DSL-1P   | 7314150478217 | 10  | 136 |
| 3946-228-8-HST-1P   | 7314150478231 | 10  | 135 |
| 3946-300-10-HST-1P  | 7314150478323 | 10  | 135 |
| 3946-300-2-CB-1P    | 7314150478354 | 10  | 138 |
| 3946-300-6-DSL-1P   | 7314150478286 | 10  | 136 |
| 3946-300-8-HST-10P  | 7314150539741 | 1   | 135 |
| 3946-300-8-HST-1P   | 7314150478309 | 10  | 135 |
| 3946-457-2-CB-1P    | 7314150478378 | 10  | 138 |
| 396-BLADE           | 7311518299057 | 100 | 634 |
| 396-BLADE-1P        | 7311518330613 | 1   | 634 |
| 396-HP              | 7311518152284 | 4   | 635 |
| 396-HP-BLADE        | 7311518156404 | 300 | 636 |
| 396-INS             | 7314150422708 | 10  | 561 |
| 396-JS              | 7311518223250 | 4   | 634 |
| 396-JS-BLADE        | 7311518223267 | 300 | 635 |
| 396-JT              | 7311518168056 | 4   | 635 |
| 396-JT-BLADE        | 7311518168063 | 300 | 636 |
| 396-LAP             | 7311518172367 | 10  | 634 |
| 4-138-06-1-0        | 7311518020927 | 10  | 27  |
| 4-138-06-1-2        | 7311518000592 | 5   | 27  |
| 4-138-08-1-0        | 7311518020934 | 10  | 27  |
| 4-138-08-1-2        | 7311518000615 | 5   | 27  |
| 4-138-10-1-0        | 7311518020958 | 10  | 27  |
| 4-138-10-1-2        | 7311518000646 | 5   | 27  |
| 4-138-12-1-0        | 7311518020965 | 5   | 27  |
| 4-138-12-1-2        | 7311518194734 | 5   | 27  |
| 4-140-06-1-0        | 7311518020989 | 10  | 27  |
| 4-140-08-1-0        | 7311518020996 | 10  | 27  |
| 4-140-08-1-2        | 7311518028169 | 5   | 27  |
| 4-140-10-1-0        | 7311518022488 | 10  | 27  |
| 4-140-10-1-2        | 7311518194741 | 5   | 27  |
| 4-142-06-1-0        | 7311518021016 | 10  | 27  |
| 4-142-08-1-0        | 7311518021023 | 10  | 27  |
| 4-142-10-1-0        | 7311518021030 | 10  | 27  |
| 4-144-08-2-0        | 7311518021054 | 10  | 28  |
| 4-144-08-2-2        | 7311518021319 | 5   | 28  |
| 4-152-08-2-2        | 7311518000691 | 5   | 28  |
| 4-153-08-1-2        | 7311518000707 | 5   | 28  |
| 4-154-08-2-2        | 7311518000714 | 10  | 28  |
| 4-155-08-2-0        | 7311518116194 | 10  | 28  |
| 4-155-10-2-0        | 7311518116200 | 5   | 28  |
| 4-183-04-2-0        | 7311518021108 | 10  | 28  |
| 4-183-04-2-2        | 7311518021401 | 5   | 28  |
| 4-183-05-2-0        | 7311518021122 | 10  | 28  |
| 4-183-05-2-2        | 7311518021418 | 5   | 28  |
| 4-183-06-2-0        | 7311518021139 | 10  | 28  |
| 4-183-06-2-2        | 7311518000769 | 5   | 28  |
| 4-183-07-2-0        | 7311518021146 | 10  | 28  |
| 4-183-07-2-2        | 7311518194710 | 5   | 28  |
| 4-183-08-2-0        | 7311518021153 | 10  | 28  |
| 4-183-08-2-2        | 7311518194727 | 5   | 28  |
| 4-183-10-2-0        | 7311518021160 | 10  | 28  |
| 4-186-04-2-0        | 7311518021191 | 10  | 28  |
| 4-186-04-2-2        | 7311518201425 | 5   | 29  |
| 4-186-05-2-0        | 7311518021214 | 10  | 28  |
| 4-186-05-2-2        | 7311518028213 | 5   | 29  |
| 4-186-06-2-0        | 7311518021221 | 10  | 29  |
| 4-186-06-2-2        | 7311518000837 | 5   | 29  |





|                 |               |    |     |
|-----------------|---------------|----|-----|
| 4-186-07-2-0    | 7311518021238 | 10 | 28  |
| 4-186-08-2-0    | 7311518021245 | 10 | 28  |
| 4-187-04-2-0    | 7311518021269 | 10 | 29  |
| 4-187-05-2-0    | 7311518021283 | 10 | 29  |
| 4-187-05-2-2    | 7311518201449 | 5  | 29  |
| 4-187-06-2-0    | 7311518021290 | 10 | 29  |
| 4-187-06-2-2    | 7311518022464 | 5  | 29  |
| 4-187-07-2-0    | 7311518021306 | 10 | 29  |
| 4-187-45-2-0    | 7311518021276 | 10 | 29  |
| 4-188-05-2-0    | 7311518021337 | 10 | 29  |
| 4-188-05-2-2    | 7311518201456 | 5  | 29  |
| 4-188-06-2-0    | 7311518021344 | 10 | 29  |
| 4-190-06-2-2    | 7311518000899 | 5  | 29  |
| 4-190-07-2-0    | 7311518021375 | 10 | 29  |
| 4-190-07-2-2    | 7311518000905 | 5  | 29  |
| 4-190-08-2-0    | 7311518021382 | 10 | 29  |
| 4-190-08-2-2    | 7311518000912 | 5  | 29  |
| 4-192-06-2-0    | 7311518021412 | 10 | 29  |
| 4-192-06-2-2    | 7311518201463 | 5  | 29  |
| 4-192-07-2-0    | 7311518021429 | 10 | 29  |
| 4-192-08-2-0    | 7311518021436 | 10 | 29  |
| 4-192-08-2-2    | 7311518201487 | 5  | 29  |
| 4-202-85-2-0    | 7311518021474 | 10 | 30  |
| 4-204-85-2-0    | 7311518021498 | 10 | 30  |
| 4-272-05-3-2    | 7311518201500 | 5  | 30  |
| 4-272-06-3-0    | 7311518021597 | 10 | 30  |
| 4-272-06-3-2    | 7311518001025 | 5  | 30  |
| 400.002.050     | 7314150249848 | 1  | 609 |
| 400.003.020     | 8412814403205 | 1  | 609 |
| 400.003.030     | 8412814403304 | 1  | 609 |
| 401-16          | 7314150400270 | 12 | 268 |
| 401-28          | 7314150384082 | 12 | 268 |
| 402-15-95       | 7314150485604 | 1  | 269 |
| 402-35          | 7314150384099 | 6  | 268 |
| 402-76          | 7314150384105 | 6  | 268 |
| 402-95-SET      | 7314150400997 | 1  | 269 |
| 4020L-M-3.2     | 7314151405038 | 5  | 43  |
| 4020L-M-3.5     | 7314151077709 | 5  | 43  |
| 4020L-M-4       | 7314151077716 | 5  | 43  |
| 4020L-M-4.5     | 7314151077723 | 5  | 43  |
| 4020L-M-5       | 7314151077730 | 5  | 43  |
| 4020L-M-5.5     | 7314151077747 | 5  | 43  |
| 4040M-10-11     | 7314151078287 | 1  | 59  |
| 4040M-10-13     | 7314153000750 | 1  | 59  |
| 4040M-12-13     | 7314151078294 | 1  | 59  |
| 4040M-13-17     | 7314151804565 | 1  | 59  |
| 4040M-14-15     | 7314151078300 | 1  | 59  |
| 4040M-16-17     | 7314151078317 | 1  | 59  |
| 4040M-16-18     | 7314151839635 | 1  | 59  |
| 4040M-18-19     | 7314151078324 | 1  | 59  |
| 4040M-20-22     | 7314151078331 | 1  | 59  |
| 4040M-21-23     | 7314151078348 | 1  | 59  |
| 4040M-6-7       | 7314151831967 | 1  | 59  |
| 4040M-8-9       | 7314151078270 | 1  | 59  |
| 4040M/6T        | 7314150112197 | 1  | 59  |
| 4040M/S6        | 7314150112180 | 1  | 59  |
| 4040Z-1/2-9/16  | 7314151831998 | 1  | 59  |
| 4040Z-13/16-7/8 | 7314150355099 | 1  | 59  |
| 4040Z-3/8-7/16  | 7314151831981 | 1  | 59  |
| 4040Z-5/8-11/16 | 7314151832001 | 1  | 59  |
| 4040Z-5/8-3/4   | 7314153001023 | 1  | 59  |
| 405-1000        | 7314150399758 | 5  | 540 |
| 405-1000-M      | 7314150399765 | 5  | 540 |
| 405-400         | 7314150399673 | 5  | 540 |
| 405-400-M       | 7314150399680 | 5  | 540 |
| 405-600         | 7314150399697 | 5  | 540 |
| 405-600-M       | 7314150399703 | 5  | 540 |
| 405-800         | 7314150399710 | 10 | 540 |
| 405-800-M       | 7314150399741 | 5  | 540 |
| 405L-400        | 7314150400461 | 10 | 540 |
| 405L-400-M      | 7314150400492 | 5  | 540 |
| 405L-600        | 7314150400478 | 10 | 540 |
| 405L-600-M      | 7314150400485 | 5  | 540 |
| 406-300         | 7314150183678 | 1  | 540 |
| 406-300-M       | 7314150186358 | 5  | 540 |
| 406-400         | 7314150183685 | 5  | 540 |
| 406-400-M       | 7314150183838 | 5  | 540 |
| 406-500         | 7314150183692 | 5  | 540 |
| 406-500-M       | 7314150186365 | 5  | 540 |
| 406-600         | 7314150245819 | 5  | 540 |
| 406-600-M       | 7314150245840 | 5  | 540 |
| 406-800         | 7314150245826 | 5  | 540 |
| 406P-400        | 7314150302574 | 10 | 540 |
| 406P-600        | 7314150302581 | 10 | 540 |
| 406T-225        | 7314150315130 | 10 | 541 |
| 407-1000        | 7314150369928 | 6  | 595 |
| 407-1400        | 7314150373703 | 6  | 595 |
| 407-700         | 7314150369911 | 5  | 595 |
| 407F-1000       | 7314150383801 | 6  | 595 |
| 407F-1400       | 7314150383818 | 6  | 595 |
| 407F-700        | 7314150383795 | 6  | 595 |
| 40B-115-165     | 7314153011879 | 25 | 60  |
| 40B-115-165-SP  | 7314153024459 | 1  | 60  |
| 40B-150-230     | 7314153024534 | 10 | 60  |
| 40B-19-50       | 7314153011848 | 25 | 60  |
| 40B-19-50-SP    | 7314153024473 | 1  | 60  |



|                 |               |     |     |
|-----------------|---------------|-----|-----|
| 40B-32-75       | 7314153011855 | 25  | 60  |
| 40B-32-75-SP    | 7314153024497 | 1   | 60  |
| 40B-50-120      | 7314153011862 | 20  | 60  |
| 40B-50-120-SP   | 7314153024510 | 1   | 60  |
| 4106-115-165    | 7314153024572 | 25  | 60  |
| 4106-150-230    | 7314153024596 | 10  | 60  |
| 4106-19-50      | 7314153011886 | 10  | 60  |
| 4106-32-75      | 7314153011893 | 25  | 60  |
| 4106-50-120     | 7314153024558 | 25  | 60  |
| 411-26          | 7314150412068 | 4   | 270 |
| 411-26-95       | 7314150412259 | 50  | 270 |
| 411-35          | 7314150412082 | 4   | 270 |
| 411-35-95       | 7314150412266 | 50  | 270 |
| 411-42          | 7314150412112 | 6   | 270 |
| 411-42-95       | 7314150412273 | 50  | 270 |
| 411-63          | 7314150412136 | 5   | 270 |
| 411-63-95       | 7314150412280 | 30  | 270 |
| 412-26-MULTI    | 7314150412174 | 5   | 270 |
| 412-26-MULTI-95 | 7314150412303 | 150 | 270 |
| 412-28-PEX      | 7314150412150 | 5   | 270 |
| 412-28-PEX-95   | 7314150412297 | 30  | 270 |
| 4124-JT-H       | 7311518267803 | 4   | 635 |
| 4128-JT-H       | 7311518267810 | 4   | 635 |
| 4130            | 7314150100019 | 3   | 233 |
| 413005000       | 8413345011860 | 12  | 598 |
| 413010000       | 8413345011877 | 12  | 598 |
| 413015000       | 8413345011884 | 12  | 598 |
| 413020000       | 8413345011891 | 6   | 598 |
| 413030000       | 8413345119986 | 1   | 598 |
| 413040000       | 8413345119993 | 1   | 598 |
| 4131            | 7314150100026 | 3   | 233 |
| 414-10          | 7311518238148 | 4   | 571 |
| 414-12          | 7311518238155 | 4   | 571 |
| 414-14          | 7311518238162 | 4   | 571 |
| 414-15          | 7311518238179 | 4   | 571 |
| 414-16          | 7311518238186 | 4   | 571 |
| 414-18          | 7311518238193 | 4   | 571 |
| 414-20          | 7311518238209 | 4   | 571 |
| 414-22          | 7311518238216 | 4   | 571 |
| 414-25          | 7311518238223 | 4   | 571 |
| 414-28          | 7311518238230 | 4   | 571 |
| 414-30          | 7311518238247 | 4   | 571 |
| 414-32          | 7311518238254 | 4   | 571 |
| 414-35          | 7311518238261 | 4   | 571 |
| 414-38          | 7311518238278 | 4   | 571 |
| 414-6           | 7311518238117 | 4   | 571 |
| 414-8           | 7311518238131 | 4   | 571 |
| 414-S3-EUR      | 7311518249205 | 1   | 571 |
| 416-1000        | 7314150314027 | 10  | 540 |
| 416-1200        | 7314150308798 | 10  | 540 |
| 416-1500        | 7314150314034 | 10  | 540 |
| 416-1800        | 7314150308804 | 10  | 540 |
| 416-2000        | 7314150308811 | 10  | 540 |
| 416-400         | 7314150314003 | 10  | 540 |
| 416-600         | 7314150308781 | 10  | 540 |
| 416-800         | 7314150314010 | 10  | 540 |
| 416-SET-1       | 7314150308828 | 5   | 541 |
| 416-SET-2       | 7314150308835 | 5   | 541 |
| 416-SET+BAG     | 7314150365470 | 1   | 540 |
| 41RM-10         | 7314153014429 | 1   | 45  |
| 41RM-11         | 7314153014436 | 1   | 45  |
| 41RM-12         | 7314153014443 | 1   | 45  |
| 41RM-13         | 7314153014450 | 1   | 45  |
| 41RM-14         | 7314153014467 | 1   | 45  |
| 41RM-17         | 7314153014474 | 1   | 45  |
| 41RM-19         | 7314153014481 | 1   | 45  |
| 41RM-21         | 7314150219742 | 1   | 45  |
| 41RM-8          | 7314153014412 | 1   | 45  |
| 41RM/SH8        | 7314150220656 | 10  | 46  |
| 41RZ-1/2        | 7314150359011 | 1   | 45  |
| 41RZ-11/16      | 7314150359042 | 1   | 45  |
| 41RZ-13/16      | 7314150359066 | 1   | 45  |
| 41RZ-3/4        | 7314150359059 | 1   | 45  |
| 41RZ-3/8        | 7314150358991 | 1   | 45  |
| 41RZ-5/16       | 7314150358984 | 1   | 45  |
| 41RZ-5/8        | 7314150359035 | 1   | 45  |
| 41RZ-7/16       | 7314150359004 | 1   | 45  |
| 41RZ-7/8        | 7314150359073 | 1   | 45  |
| 41RZ-9/16       | 7314150359028 | 1   | 45  |
| 420SC-25        | 7314150169825 | 10  | 589 |
| 420SC-50        | 7314150169832 | 5   | 589 |
| 420SH-100-200   | 7314150359691 | 10  | 588 |
| 420SH-120-1000  | 7314150359790 | 6   | 588 |
| 420SH-120-1250  | 7314150359806 | 6   | 588 |
| 420SH-120-1500  | 7314150359813 | 6   | 588 |
| 420SH-120-250   | 7314150359707 | 8   | 588 |
| 420SH-120-300   | 7314150359745 | 8   | 588 |
| 420SH-120-400   | 7314150359752 | 6   | 588 |
| 420SH-120-500   | 7314150359769 | 6   | 588 |
| 420SH-120-600   | 7314150359776 | 6   | 588 |
| 420SH-120-800   | 7314150359783 | 6   | 588 |
| 420SH-140-400   | 7314150359820 | 6   | 588 |
| 420SH-175-400   | 7314150359837 | 6   | 588 |
| 420SH-50-100    | 7314150359646 | 10  | 588 |
| 420SH-50-200    | 7314150359653 | 10  | 588 |
| 420SH-60-120    | 7314150359660 | 12  | 588 |



| Item Code    | Item Code     | Quantity | Item Code |
|--------------|---------------|----------|-----------|
| 420SH-60-300 | 7314150359677 | 12       | 588       |
| 420SH-80-160 | 7314150359684 | 12       | 588       |
| 4211-11-6T   | 7311518152000 | 4        | 635       |
| 4211-14-6T   | 7311518128883 | 4        | 635       |
| 4212-11-6T   | 7311518002060 | 4        | 635       |
| 4212-14-6T   | 7311518002077 | 4        | 635       |
| 422P-10      | 7311518248369 | 4        | 572       |
| 422P-12      | 7311518248376 | 4        | 572       |
| 422P-16      | 7311518248383 | 4        | 572       |
| 422P-20      | 7311518248390 | 4        | 572       |
| 422P-25      | 7311518248406 | 4        | 572       |
| 422P-6       | 7311518248352 | 4        | 572       |
| 4231         | 7314150100033 | 3        | 235       |
| 4239         | 7314150100088 | 3        | 235       |
| 424P-10      | 7311518238315 | 4        | 570       |
| 424P-12      | 7311518238322 | 4        | 570       |
| 424P-14      | 7311518238339 | 4        | 570       |
| 424P-15      | 7311518238346 | 4        | 570       |
| 424P-16      | 7311518238353 | 4        | 570       |
| 424P-18      | 7311518238360 | 4        | 570       |
| 424P-20      | 7311518238377 | 4        | 570       |
| 424P-22      | 7311518238384 | 4        | 570       |
| 424P-24      | 7311518238391 | 4        | 570       |
| 424P-25      | 7311518238407 | 4        | 570       |
| 424P-26      | 7311518238414 | 4        | 570       |
| 424P-28      | 7311518238421 | 4        | 570       |
| 424P-30      | 7311518238438 | 4        | 570       |
| 424P-32      | 7311518238445 | 4        | 570       |
| 424P-35      | 7311518238452 | 4        | 570       |
| 424P-38      | 7311518238469 | 4        | 570       |
| 424P-4       | 7311518238285 | 4        | 570       |
| 424P-40      | 7311518238476 | 4        | 570       |
| 424P-6       | 7311518238292 | 4        | 570       |
| 424P-8       | 7311518238308 | 4        | 570       |
| 424P-S3-EUR  | 7311518249199 | 1        | 570       |
| 424P-S6-EUR  | 7311518269968 | 1        | 571       |
| 424P-S6-GER  | 7311518280086 | 1        | 571       |
| 424P-S6-LR   | 7314150423804 | 1        | 570       |
| 424P-S6-PP   | 7314150326662 | 1        | 571       |
| 424P-S8-EUR  | 7311518276393 | 1        | 571       |
| 425-081      | 7311518010669 | 1        | 572       |
| 425-082      | 7311518010676 | 1        | 572       |
| 425-083      | 7311518010683 | 1        | 572       |
| 425-10       | 7311518004613 | 4        | 572       |
| 425-12       | 7311518004620 | 4        | 572       |
| 425-14       | 7311518004637 | 4        | 572       |
| 425-15       | 7311518017767 | 4        | 572       |
| 425-16       | 7311518004644 | 4        | 572       |
| 425-18       | 7311518004651 | 4        | 572       |
| 425-20       | 7311518004668 | 4        | 572       |
| 425-22       | 7311518004675 | 4        | 572       |
| 425-24       | 7311518005993 | 4        | 572       |
| 425-25       | 7311518004682 | 4        | 572       |
| 425-26       | 7311518006006 | 4        | 572       |
| 425-28       | 7311518004699 | 4        | 572       |
| 425-30       | 7311518004705 | 4        | 572       |
| 425-32       | 7311518004712 | 4        | 572       |
| 425-35       | 7311518017774 | 4        | 572       |
| 425-38       | 7311518004729 | 4        | 572       |
| 425-4        | 7311518030810 | 4        | 572       |
| 425-40       | 7311518017781 | 4        | 572       |
| 425-6        | 7311518004590 | 4        | 572       |
| 425-8        | 7311518004606 | 4        | 572       |
| 426-1000     | 7311518004309 | 1        | 539       |
| 426-1200     | 7311518004316 | 1        | 539       |
| 426-400      | 7311518004255 | 1        | 539       |
| 426-600      | 7311518004279 | 1        | 539       |
| 426-800      | 7311518004293 | 1        | 539       |
| 426TOR9      | 7314150125319 | 10       | 541       |
| 427-13       | 7314150403578 | 4        | 592       |
| 427-16       | 7311518025410 | 4        | 592       |
| 427-20       | 7311518025427 | 4        | 592       |
| 427-24       | 7314150402878 | 4        | 592       |
| 427-700      | 7314150338092 | 6        | 592       |
| 427-8        | 7314150402854 | 4        | 592       |
| 427S-16      | 7314150404247 | 4        | 592       |
| 427S-20      | 7314150404261 | 4        | 592       |
| 428-16       | 7311518012380 | 4        | 592       |
| 428-700      | 7314150338108 | 6        | 593       |
| 428F-13      | 7314150436392 | 4        | 592       |
| 428F-16      | 7314150436408 | 4        | 592       |
| 428F-20      | 7314150436422 | 4        | 592       |
| 428F-24      | 7314150436439 | 4        | 592       |
| 428F-8       | 7314150436378 | 4        | 592       |
| 428S-16      | 7314150424030 | 4        | 592       |
| 428S-20      | 7314150424047 | 4        | 592       |
| 429-13       | 7311518012250 | 4        | 592       |
| 429-16       | 7311518012403 | 4        | 592       |
| 429-20       | 7311518012410 | 4        | 592       |
| 429-8        | 7311518040703 | 4        | 592       |
| 42RM/S12     | 7314150384785 | 1        | 46        |
| 4307         | 7314151079444 | 1        | 60        |
| 4310         | 7314151079451 | 1        | 60        |
| 434-10       | 7311518238506 | 4        | 570       |
| 434-12       | 7311518238513 | 4        | 570       |
| 434-14       | 7311518238520 | 4        | 570       |

| Item Code    | Item Code     | Quantity | Item Code |
|--------------|---------------|----------|-----------|
| 434-15       | 7311518238537 | 4        | 570       |
| 434-16       | 7311518238544 | 4        | 570       |
| 434-18       | 7311518238551 | 4        | 570       |
| 434-20       | 7311518238568 | 4        | 570       |
| 434-22       | 7311518238575 | 4        | 570       |
| 434-25       | 7311518238582 | 4        | 570       |
| 434-28       | 7311518238599 | 4        | 570       |
| 434-30       | 7311518238605 | 4        | 570       |
| 434-32       | 7311518238612 | 4        | 570       |
| 434-35       | 7311518238629 | 4        | 570       |
| 434-38       | 7311518238636 | 4        | 570       |
| 434-50       | 7311518285388 | 4        | 570       |
| 434-6        | 7311518238483 | 4        | 570       |
| 434-8        | 7311518238490 | 4        | 570       |
| 434-S3-EUR   | 7311518249212 | 1        | 570       |
| 434-S6-EUR   | 7311518267544 | 1        | 570       |
| 434-S6-LR    | 7314150423811 | 1        | 570       |
| 434-S6-PP    | 7314150326655 | 1        | 570       |
| 434-S8-EUR   | 7311518295110 | 1        | 570       |
| 439000000    | 8413345129282 | 1        | 473       |
| 439000001    | 7314150268788 | 1        | 473       |
| 439000002    | 7314150309702 | 1        | 473       |
| 439000003    | 7314150309719 | 1        | 473       |
| 439000004    | 7314150427666 | 1        | 473       |
| 4400-11      | 7311518200596 | 10       | 636       |
| 4400-11-BULK | 7311518200633 | 10       | 636       |
| 4400-14      | 7311518200602 | 10       | 636       |
| 4400-14-BULK | 7311518200640 | 10       | 636       |
| 440102500    | 8413345098977 | 10       | 595       |
| 440103000    | 8413345098991 | 10       | 595       |
| 4411-1.00    | 7314150372744 | 1        | 151       |
| 4411-1.50    | 7314150372768 | 1        | 151       |
| 4411-10.00   | 7314150372973 | 1        | 151       |
| 4411-10.20   | 7314150372980 | 1        | 151       |
| 4411-10.50   | 7314150470488 | 1        | 151       |
| 4411-11.00   | 7314150372997 | 1        | 151       |
| 4411-11.50   | 7314150470495 | 1        | 151       |
| 4411-12.00   | 7314150373000 | 1        | 151       |
| 4411-12.50   | 7314150470501 | 1        | 151       |
| 4411-13.00   | 7314150373017 | 1        | 151       |
| 4411-2.00    | 7314150372775 | 1        | 151       |
| 4411-2.50    | 7314150372782 | 1        | 151       |
| 4411-3.00    | 7314150372799 | 1        | 151       |
| 4411-3.25    | 7314150372805 | 1        | 151       |
| 4411-3.30    | 7314150372812 | 1        | 151       |
| 4411-3.50    | 7314150372829 | 1        | 151       |
| 4411-4.00    | 7314150372836 | 1        | 151       |
| 4411-4.20    | 7314150372843 | 1        | 151       |
| 4411-4.25    | 7314150372850 | 1        | 151       |
| 4411-4.50    | 7314150372867 | 1        | 151       |
| 4411-5.00    | 7314150372874 | 1        | 151       |
| 4411-5.50    | 7314150372881 | 1        | 151       |
| 4411-6.00    | 7314150372898 | 1        | 151       |
| 4411-6.50    | 7314150372904 | 1        | 151       |
| 4411-6.80    | 7314150372911 | 1        | 151       |
| 4411-7.00    | 7314150372928 | 1        | 151       |
| 4411-7.50    | 7314150372935 | 1        | 151       |
| 4411-8.00    | 7314150372942 | 1        | 151       |
| 4411-8.50    | 7314150372959 | 1        | 151       |
| 4411-9.00    | 7314150372966 | 1        | 151       |
| 4411-9.50    | 7314150394463 | 1        | 151       |
| 4413-1.00    | 7314150371754 | 1        | 152       |
| 4413-1.50    | 7314150371761 | 1        | 152       |
| 4413-10.00   | 7314150372034 | 1        | 152       |
| 4413-10.20   | 7314150372041 | 1        | 152       |
| 4413-10.50   | 7314150470556 | 25       | 152       |
| 4413-11.00   | 7314150372058 | 1        | 152       |
| 4413-11.50   | 7314150470563 | 25       | 152       |
| 4413-12.00   | 7314150372065 | 1        | 152       |
| 4413-12.50   | 7314150470570 | 25       | 152       |
| 4413-13.00   | 7314150372072 | 1        | 152       |
| 4413-2.00    | 7314150371785 | 1        | 152       |
| 4413-2.50    | 7314150371792 | 1        | 152       |
| 4413-3.00    | 7314150371815 | 1        | 152       |
| 4413-3.25    | 7314150371822 | 1        | 152       |
| 4413-3.30    | 7314150371877 | 1        | 152       |
| 4413-3.50    | 7314150371884 | 1        | 152       |
| 4413-4.00    | 7314150371891 | 1        | 152       |
| 4413-4.20    | 7314150371907 | 1        | 152       |
| 4413-4.25    | 7314150371914 | 1        | 152       |
| 4413-4.50    | 7314150371921 | 1        | 152       |
| 4413-5.00    | 7314150371938 | 1        | 152       |
| 4413-5.50    | 7314150371945 | 1        | 152       |
| 4413-6.00    | 7314150371952 | 1        | 152       |
| 4413-6.50    | 7314150371969 | 1        | 152       |
| 4413-6.80    | 7314150371976 | 1        | 152       |
| 4413-7.00    | 7314150371983 | 1        | 152       |
| 4413-7.50    | 7314150371990 | 1        | 152       |
| 4413-8.00    | 7314150372003 | 1        | 152       |
| 4413-8.50    | 7314150372010 | 1        | 152       |
| 4413-9.00    | 7314150372027 | 1        | 152       |
| 4413-9.50    | 7314150394456 | 1        | 152       |
| 4415-1.00    | 7314150394210 | 1        | 153       |
| 4415-1.50    | 7314150394227 | 1        | 153       |
| 4415-10.00   | 7314150394401 | 1        | 153       |
| 4415-10.50   | 7314150470525 | 1        | 153       |





|                 |               |    |     |
|-----------------|---------------|----|-----|
| 4415-11.00      | 7314150394418 | 1  | 153 |
| 4415-11.50      | 7314150470532 | 1  | 153 |
| 4415-12.00      | 7314150394425 | 1  | 153 |
| 4415-12.50      | 7314150470549 | 1  | 153 |
| 4415-13.00      | 7314150394432 | 1  | 153 |
| 4415-13.50      | 7314150441495 | 1  | 153 |
| 4415-14.00      | 7314150441501 | 1  | 153 |
| 4415-14.50      | 7314150441518 | 1  | 153 |
| 4415-15.00      | 7314150441525 | 1  | 153 |
| 4415-15.50      | 7314150441532 | 1  | 153 |
| 4415-16.00      | 7314150441549 | 1  | 153 |
| 4415-16.50      | 7314150441556 | 1  | 153 |
| 4415-17.00      | 7314150441563 | 1  | 153 |
| 4415-17.50      | 7314150441570 | 1  | 153 |
| 4415-18.00      | 7314150441587 | 1  | 153 |
| 4415-18.50      | 7314150441594 | 1  | 153 |
| 4415-19.00      | 7314150441600 | 1  | 153 |
| 4415-19.50      | 7314150441617 | 1  | 153 |
| 4415-2.00       | 7314150394234 | 1  | 153 |
| 4415-2.50       | 7314150394241 | 1  | 153 |
| 4415-20.00      | 7314150441624 | 1  | 153 |
| 4415-3.00       | 7314150394258 | 1  | 153 |
| 4415-3.25       | 7314150394265 | 1  | 153 |
| 4415-3.50       | 7314150394272 | 1  | 153 |
| 4415-4.00       | 7314150394289 | 1  | 153 |
| 4415-4.25       | 7314150394296 | 1  | 153 |
| 4415-4.50       | 7314150394302 | 1  | 153 |
| 4415-5.00       | 7314150394319 | 1  | 153 |
| 4415-5.50       | 7314150394326 | 1  | 153 |
| 4415-6.00       | 7314150394333 | 1  | 153 |
| 4415-6.50       | 7314150394340 | 1  | 153 |
| 4415-7.00       | 7314150394357 | 1  | 153 |
| 4415-7.50       | 7314150394364 | 1  | 153 |
| 4415-8.00       | 7314150394371 | 1  | 153 |
| 4415-8.50       | 7314150394388 | 1  | 153 |
| 4415-9.00       | 7314150394395 | 1  | 153 |
| 442             | 7311518002848 | 10 | 548 |
| 442 B           | 7314150008957 | 1  | 266 |
| 442-3P          | 7314150309610 | 10 | 548 |
| 4420-11         | 7311518200619 | 10 | 636 |
| 4420-11-BULK    | 7311518200657 | 10 | 636 |
| 4420-14         | 7311518200626 | 10 | 636 |
| 4420-14-BULK    | 7311518200664 | 10 | 636 |
| 443 B           | 7314150008971 | 1  | 266 |
| 4430            | 7314150100040 | 3  | 245 |
| 4435-12.4       | 7314150465163 | 1  | 154 |
| 444 B           | 7314150009008 | 1  | 266 |
| 4480/2-ZD       | 7311518276911 | 1  | 271 |
| 4480IM          | 7314150263165 | 1  | 271 |
| 4480MM          | 7314150263158 | 1  | 271 |
| 449             | 7311518005337 | 10 | 548 |
| 44Z-1/2-9/16    | 7314150375233 | 10 | 53  |
| 44Z-1/4-5/16    | 7314150375196 | 10 | 53  |
| 44Z-11/16-13/16 | 7314150375264 | 5  | 53  |
| 44Z-11/16-3/4   | 7314150375257 | 5  | 53  |
| 44Z-3/8-7/16    | 7314150375219 | 10 | 53  |
| 44Z-5/16-3/8    | 7314150375202 | 10 | 53  |
| 44Z-5/8-3/4     | 7314150375240 | 5  | 53  |
| 44Z-7/16-1/2    | 7314150375226 | 10 | 53  |
| 451             | 7311518014506 | 10 | 548 |
| 4511-0.50-10P   | 7314150373079 | 1  | 151 |
| 4511-0.75-10P   | 7314150373062 | 1  | 151 |
| 4511-1.00-10P   | 7314150373055 | 1  | 151 |
| 4511-1.50-10P   | 7314150373086 | 1  | 151 |
| 4511-1.75-10P   | 7314150373093 | 1  | 151 |
| 4511-10.00-5P   | 7314150373444 | 1  | 151 |
| 4511-10.20-5P   | 7314150373468 | 1  | 151 |
| 4511-10.30-5P   | 7314150373475 | 1  | 151 |
| 4511-10.50-5P   | 7314150373482 | 1  | 151 |
| 4511-10.80-5P   | 7314150373499 | 1  | 151 |
| 4511-11.00-5P   | 7314150373505 | 1  | 151 |
| 4511-11.50-5P   | 7314150373512 | 1  | 151 |
| 4511-12.00-5P   | 7314150373529 | 1  | 151 |
| 4511-12.50-5P   | 7314150373536 | 1  | 151 |
| 4511-12.80-5P   | 7314150373543 | 1  | 151 |
| 4511-13.00-5P   | 7314150373550 | 1  | 151 |
| 4511-13.50-1P   | 7314150373567 | 1  | 151 |
| 4511-14.00-1P   | 7314150373574 | 1  | 151 |
| 4511-14.50-1P   | 7314150373581 | 1  | 151 |
| 4511-15.00-1P   | 7314150373598 | 1  | 151 |
| 4511-15.50-1P   | 7314150373604 | 1  | 151 |
| 4511-16.00-1P   | 7314150373611 | 1  | 151 |
| 4511-16.50-1P   | 7314150373628 | 1  | 151 |
| 4511-17.00-1P   | 7314150373635 | 1  | 151 |
| 4511-17.50-1P   | 7314150373642 | 1  | 151 |
| 4511-18.00-1P   | 7314150373659 | 1  | 151 |
| 4511-18.50-1P   | 7314150373673 | 1  | 151 |
| 4511-19.00-1P   | 7314150373680 | 1  | 151 |
| 4511-19.50-1P   | 7314150373697 | 1  | 151 |
| 4511-2.00-10P   | 7314150373109 | 1  | 151 |
| 4511-2.50-10P   | 7314150373116 | 1  | 151 |
| 4511-2.70-10P   | 7314150373123 | 1  | 151 |
| 4511-2.90-10P   | 7314150373130 | 1  | 151 |
| 4511-20.00-1P   | 7314150373666 | 1  | 151 |
| 4511-3.00-10P   | 7314150373147 | 1  | 151 |
| 4511-3.10-10P   | 7314150373185 | 1  | 151 |



|               |               |   |     |
|---------------|---------------|---|-----|
| 4511-3.25-10P | 7314150373192 | 1 | 151 |
| 4511-3.30-10P | 7314150373208 | 1 | 151 |
| 4511-3.50-10P | 7314150373215 | 1 | 151 |
| 4511-3.80-10P | 7314150373222 | 1 | 151 |
| 4511-4.00-10P | 7314150373239 | 1 | 151 |
| 4511-4.20-10P | 7314150373246 | 1 | 151 |
| 4511-4.50-10P | 7314150373253 | 1 | 151 |
| 4511-4.80-10P | 7314150373260 | 1 | 151 |
| 4511-5.00-10P | 7314150373277 | 1 | 151 |
| 4511-5.20-10P | 7314150373284 | 1 | 151 |
| 4511-5.50-10P | 7314150373291 | 1 | 151 |
| 4511-6.00-10P | 7314150373307 | 1 | 151 |
| 4511-6.20-10P | 7314150373314 | 1 | 151 |
| 4511-6.50-10P | 7314150373321 | 1 | 151 |
| 4511-6.80-10P | 7314150373338 | 1 | 151 |
| 4511-7.00-10P | 7314150373345 | 1 | 151 |
| 4511-7.20-10P | 7314150373352 | 1 | 151 |
| 4511-7.50-10P | 7314150373369 | 1 | 151 |
| 4511-7.80-10P | 7314150373376 | 1 | 151 |
| 4511-8.00-10P | 7314150373383 | 1 | 151 |
| 4511-8.50-10P | 7314150373390 | 1 | 151 |
| 4511-8.60-10P | 7314150373406 | 1 | 151 |
| 4511-8.80-10P | 7314150373413 | 1 | 151 |
| 4511-9.00-10P | 7314150373420 | 1 | 151 |
| 4511-9.20-10P | 7314150373437 | 1 | 151 |
| 4511-9.50-10P | 7311518339081 | 1 | 151 |
| 4511-9.60-10P | 7314150373451 | 1 | 151 |
| 4511-SET-19   | 7314150373031 | 1 | 151 |
| 4511-SET-25   | 7314150373048 | 1 | 152 |
| 4511-SET-6    | 7314150373024 | 1 | 151 |
| 4513-1.00-10P | 7314150372119 | 1 | 152 |
| 4513-1.50-10P | 7314150372126 | 1 | 152 |
| 4513-1.75-10P | 7314150372133 | 1 | 152 |
| 4513-10.00-5P | 7314150391998 | 1 | 152 |
| 4513-10.20-5P | 7314150392001 | 1 | 152 |
| 4513-10.30-5P | 7314150392018 | 1 | 152 |
| 4513-10.50-5P | 7314150392025 | 1 | 152 |
| 4513-10.80-5P | 7314150392032 | 1 | 152 |
| 4513-11.00-5P | 7314150392049 | 1 | 152 |
| 4513-11.50-5P | 7314150392056 | 1 | 152 |
| 4513-12.00-5P | 7314150392063 | 1 | 152 |
| 4513-12.50-5P | 7314150392070 | 1 | 152 |
| 4513-12.80-5P | 7314150392087 | 1 | 152 |
| 4513-13.00-5P | 7314150392094 | 1 | 152 |
| 4513-13.50-1P | 7314150392100 | 1 | 152 |
| 4513-14.00-1P | 7314150392117 | 1 | 152 |
| 4513-14.50-1P | 7314150392124 | 1 | 152 |
| 4513-15.00-1P | 7314150392131 | 1 | 152 |
| 4513-15.50-1P | 7314150392148 | 1 | 152 |
| 4513-16.00-1P | 7314150392155 | 1 | 152 |
| 4513-16.50-1P | 7314150392162 | 1 | 152 |
| 4513-17.00-1P | 7314150392179 | 1 | 152 |
| 4513-17.50-1P | 7314150392186 | 1 | 152 |
| 4513-18.00-1P | 7314150392193 | 1 | 152 |
| 4513-18.50-1P | 7314150392200 | 1 | 152 |
| 4513-19.00-1P | 7314150392216 | 1 | 152 |
| 4513-19.50-1P | 7314150392223 | 1 | 152 |
| 4513-2.00-10P | 7314150372140 | 1 | 152 |
| 4513-2.50-10P | 7314150372157 | 1 | 152 |
| 4513-2.70-10P | 7314150372164 | 1 | 152 |
| 4513-2.90-10P | 7314150372171 | 1 | 152 |
| 4513-20.00-1P | 7314150392230 | 1 | 152 |
| 4513-3.00-10P | 7314150372188 | 1 | 152 |
| 4513-3.10-10P | 7314150372195 | 1 | 152 |
| 4513-3.25-10P | 7314150372201 | 1 | 152 |
| 4513-3.30-10P | 7314150372218 | 1 | 152 |
| 4513-3.50-10P | 7314150372225 | 1 | 152 |
| 4513-3.80-10P | 7314150372232 | 1 | 152 |
| 4513-4.00-10P | 7314150372249 | 1 | 152 |
| 4513-4.20-10P | 7314150372256 | 1 | 152 |
| 4513-4.50-10P | 7314150372263 | 1 | 152 |
| 4513-4.80-10P | 7314150372270 | 1 | 152 |
| 4513-5.00-10P | 7314150372287 | 1 | 152 |
| 4513-5.20-10P | 7314150372294 | 1 | 152 |
| 4513-5.50-10P | 7314150372300 | 1 | 152 |
| 4513-6.00-10P | 7314150372317 | 1 | 152 |
| 4513-6.20-10P | 7314150372324 | 1 | 152 |
| 4513-6.50-10P | 7314150372331 | 1 | 152 |
| 4513-6.80-10P | 7314150372348 | 1 | 152 |
| 4513-7.00-10P | 7314150372355 | 1 | 152 |
| 4513-7.20-10P | 7314150372362 | 1 | 152 |
| 4513-7.50-10P | 7314150372379 | 1 | 152 |
| 4513-7.80-10P | 7314150372386 | 1 | 152 |
| 4513-8.00-10P | 7314150372393 | 1 | 152 |
| 4513-8.50-10P | 7314150372409 | 1 | 152 |
| 4513-8.60-10P | 7314150372416 | 1 | 152 |
| 4513-8.80-10P | 7314150372423 | 1 | 152 |
| 4513-9.00-10P | 7314150372430 | 1 | 152 |
| 4513-9.20-10P | 7314150372447 | 1 | 152 |
| 4513-9.50-10P | 7314150372454 | 1 | 152 |
| 4513-9.60-10P | 7314150372461 | 1 | 152 |
| 4513-SET-19   | 7314150372096 | 1 | 152 |
| 4513-SET-25   | 7314150372102 | 1 | 153 |
| 4513-SET-6    | 7314150372089 | 1 | 152 |
| 4515-1.00-10P | 7314150441228 | 1 | 153 |
| 4515-1.50-10P | 7314150441235 | 1 | 153 |

| Part Number    | Quantity | Price |
|----------------|----------|-------|
| 4515-10.00-10P | 1        | 153   |
| 4515-10.50-5P  | 1        | 153   |
| 4515-11.00-5P  | 1        | 153   |
| 4515-11.50-5P  | 1        | 153   |
| 4515-12.00-5P  | 1        | 153   |
| 4515-12.50-5P  | 1        | 153   |
| 4515-13.00-5P  | 1        | 153   |
| 4515-2.00-10P  | 1        | 153   |
| 4515-2.50-10P  | 1        | 153   |
| 4515-3.00-10P  | 1        | 153   |
| 4515-3.25-10P  | 1        | 153   |
| 4515-3.50-10P  | 1        | 153   |
| 4515-4.00-10P  | 1        | 153   |
| 4515-4.25-10P  | 1        | 153   |
| 4515-4.50-10P  | 1        | 153   |
| 4515-5.00-10P  | 1        | 153   |
| 4515-5.50-10P  | 1        | 153   |
| 4515-6.00-10P  | 1        | 153   |
| 4515-6.50-10P  | 1        | 153   |
| 4515-7.00-10P  | 1        | 153   |
| 4515-7.50-10P  | 1        | 153   |
| 4515-8.00-10P  | 1        | 153   |
| 4515-8.50-10P  | 1        | 153   |
| 4515-9.00-10P  | 1        | 153   |
| 4515-9.50-10P  | 1        | 153   |
| 4515-SET-19    | 1        | 153   |
| 4515-SET-25    | 1        | 153   |
| 4518-3         | 1        | 367   |
| 4518-4         | 1        | 367   |
| 4518-5         | 1        | 367   |
| 4519-1         | 1        | 366   |
| 4519-1/S       | 1        | 365   |
| 4519-2         | 1        | 366   |
| 4519-3         | 1        | 366   |
| 4521N-0        | 1        | 367   |
| 4521N-00       | 1        | 367   |
| 4521N-A        | 1        | 367   |
| 4521N-B        | 1        | 367   |
| 4521N-C        | 1        | 367   |
| 4521N-D        | 1        | 367   |
| 4521N-E        | 1        | 367   |
| 4521N-F        | 1        | 367   |
| 4521N-G        | 1        | 367   |
| 4521N-H        | 1        | 367   |
| 4521N-I        | 1        | 367   |
| 4521N-K        | 1        | 367   |
| 4521N-L        | 1        | 367   |
| 4521N-M        | 1        | 367   |
| 4521N-S        | 1        | 367   |
| 4521N-T        | 1        | 367   |
| 4521N/7        | 1        | 367   |
| 4522-1         | 1        | 367   |
| 4522-2         | 1        | 367   |
| 4523G          | 1        | 367   |
| 4524G          | 1        | 367   |
| 4528-1         | 1        | 365   |
| 4528M1         | 1        | 365   |
| 4528M2         | 1        | 365   |
| 4528M3         | 1        | 365   |
| 4528M4         | 1        | 365   |
| 4528M5         | 1        | 365   |
| 4529-15        | 1        | 364   |
| 4529-8         | 1        | 364   |
| 4530           | 3        | 246   |
| 4532-0         | 1        | 364   |
| 4532-A         | 1        | 364   |
| 4532-AL        | 1        | 364   |
| 4532-B         | 1        | 364   |
| 4532-BL        | 1        | 364   |
| 4532-C         | 1        | 364   |
| 4532-CD/S      | 1        | 364   |
| 4532-CL        | 1        | 364   |
| 4532-D         | 1        | 364   |
| 4532-E         | 1        | 364   |
| 4532-EFG/S     | 1        | 364   |
| 4532-F         | 1        | 364   |
| 4532-G         | 1        | 364   |
| 4532-G-SO      | 1        | 364   |
| 4532-H         | 1        | 364   |
| 4532-H/S       | 1        | 364   |
| 4532-OAB/S     | 1        | 364   |
| 4532K1         | 1        | 364   |
| 4532K2         | 1        | 364   |
| 4532K3         | 1        | 364   |
| 4532K4         | 1        | 364   |
| 4532LK1        | 1        | 364   |
| 4532LK2        | 1        | 364   |
| 4532LK3        | 1        | 364   |
| 4532LK4        | 1        | 364   |
| 4532LK5        | 1        | 364   |
| 4532ST/5       | 1        | 364   |
| 4533HP         | 1        | 364   |
| 4533HP/S       | 1        | 364   |
| 4533HPK        | 1        | 364   |
| 4533M          | 1        | 364   |
| 4533M/S        | 1        | 364   |

| Part Number | Quantity | Price |
|-------------|----------|-------|
| 4533MK      | 1        | 364   |
| 4537-1      | 1        | 365   |
| 4537-2      | 1        | 365   |
| 4537-3      | 1        | 365   |
| 4537-4      | 1        | 365   |
| 4540-17     | 1        | 366   |
| 4540-17/S   | 1        | 366   |
| 4540-25     | 1        | 366   |
| 4540-25/S   | 1        | 366   |
| 4541-A      | 1        | 365   |
| 4541-B      | 1        | 365   |
| 4542-A      | 1        | 365   |
| 4542-B      | 1        | 365   |
| 4543-1      | 1        | 365   |
| 4543-1/S    | 1        | 365   |
| 4543-10     | 1        | 365   |
| 4543-2      | 1        | 365   |
| 4543-2/S    | 1        | 365   |
| 4543-20     | 1        | 365   |
| 4543-3      | 1        | 365   |
| 4543-3/S    | 1        | 365   |
| 4543-30     | 1        | 365   |
| 4544-1      | 1        | 365   |
| 4544-10     | 1        | 365   |
| 4544-110/S  | 1        | 365   |
| 4544-2      | 1        | 365   |
| 4544-20     | 1        | 365   |
| 4544-220/S  | 1        | 365   |
| 4544-3      | 1        | 365   |
| 4544-30     | 1        | 365   |
| 4544-4      | 1        | 365   |
| 4544-440/S  | 1        | 365   |
| 4545-1      | 1        | 368   |
| 4545-2      | 1        | 368   |
| 4545-3      | 1        | 368   |
| 4545-4      | 1        | 368   |
| 4545-5      | 1        | 368   |
| 4545-N1     | 1        | 367   |
| 4545-N11    | 1        | 367   |
| 4545-N2     | 1        | 367   |
| 4545-N21    | 1        | 367   |
| 4551-A      | 1        | 366   |
| 4551-B      | 1        | 366   |
| 4551-C      | 1        | 366   |
| 4551-D      | 1        | 366   |
| 4552-1      | 1        | 366   |
| 4552-2      | 1        | 366   |
| 4552-3      | 1        | 366   |
| 4553        | 1        | 368   |
| 4559-12     | 1        | 239   |
| 4559-12A JC | 1        | 239   |
| 4559-18     | 8        | 239   |
| 4559-18B JC | 1        | 239   |
| 4559-24     | 6        | 239   |
| 4559-24B JC | 1        | 239   |
| 4559-30     | 5        | 239   |
| 4559-30B JC | 1        | 239   |
| 4559-36     | 3        | 239   |
| 4559-36B JC | 1        | 239   |
| 4559-42     | 2        | 239   |
| 4559-42A JC | 1        | 239   |
| 4560-210    | 1        | 239   |
| 4574        | 1        | 366   |
| 4577        | 1        | 368   |
| 4578        | 1        | 367   |
| 4579        | 1        | 368   |
| 4580N/7     | 1        | 366   |
| 4581N-1     | 1        | 366   |
| 4581NA      | 1        | 366   |
| 4581NB      | 1        | 366   |
| 4581NB2     | 1        | 366   |
| 4581NC      | 1        | 366   |
| 4582N-1     | 1        | 366   |
| 4582N-2     | 1        | 366   |
| 4582NA      | 1        | 366   |
| 4582NB      | 1        | 366   |
| 4583N-1     | 1        | 366   |
| 4583N-2     | 1        | 366   |
| 4583NA      | 1        | 366   |
| 4583NB      | 1        | 366   |
| 4590SHS5    | 4        | 368   |
| 4591        | 1        | 368   |
| 4592        | 1        | 368   |
| 4593        | 1        | 368   |
| 4594VWT4    | 5        | 335   |
| 45S/H1.5    | 1        | 165   |
| 45S/H1.5-2P | 1        | 165   |
| 45S/H2      | 1        | 165   |
| 45S/H2-2P   | 1        | 165   |
| 45S/H2.5    | 1        | 165   |
| 45S/H2.5-2P | 1        | 165   |
| 45S/H3      | 1        | 165   |
| 45S/H3-2P   | 1        | 165   |
| 45S/PH1     | 1        | 165   |
| 45S/PH1-2P  | 1        | 165   |
| 45S/PH2     | 1        | 165   |



# 45S/PH2-2P



|                 |               |    |     |
|-----------------|---------------|----|-----|
| 45S/PH2-2P      | 7314150261499 | 1  | 165 |
| 4610-1          | 7314151724993 | 1  | 368 |
| 4611-2          | 7314151725372 | 1  | 368 |
| 4611-3          | 7314150125043 | 1  | 368 |
| 4614-1          | 7314151725457 | 1  | 366 |
| 4614-2          | 7314151725532 | 1  | 366 |
| 4626-10.0       | 7314150457670 | 1  | 156 |
| 4626-4.0        | 7314150457632 | 1  | 156 |
| 4626-5.0        | 7314150457649 | 1  | 156 |
| 4626-6.0        | 7314150457656 | 1  | 156 |
| 4626-8.0        | 7314150457663 | 1  | 156 |
| 4629-10.0       | 7314150465385 | 1  | 156 |
| 4629-4.0        | 7314150465347 | 1  | 156 |
| 4629-5.0        | 7314150465354 | 1  | 156 |
| 4629-6.0        | 7314150465361 | 1  | 156 |
| 4629-8.0        | 7314150465378 | 1  | 156 |
| 4629-SET-5      | 7314150467204 | 10 | 156 |
| 4630            | 7314150216154 | 1  | 610 |
| 4641-10-120     | 7314150383085 | 1  | 150 |
| 4641-10-200     | 7314150383115 | 1  | 150 |
| 4641-10-400     | 7314150383207 | 1  | 150 |
| 4641-10-600     | 7314150383221 | 1  | 150 |
| 4641-11-150     | 7314150383122 | 1  | 150 |
| 4641-12-150     | 7314150383139 | 1  | 150 |
| 4641-12-200     | 7314150383146 | 1  | 150 |
| 4641-12-400     | 7314150383238 | 1  | 150 |
| 4641-12-600     | 7314150383245 | 1  | 150 |
| 4641-13-150     | 7314150383153 | 1  | 150 |
| 4641-14-150     | 7314150383160 | 1  | 150 |
| 4641-14-400     | 7314150383252 | 1  | 150 |
| 4641-14-600     | 7314150383269 | 1  | 150 |
| 4641-16-150     | 7314150383177 | 1  | 150 |
| 4641-16-400     | 7314150383276 | 1  | 150 |
| 4641-16-600     | 7314150383283 | 1  | 150 |
| 4641-18-400     | 7314150383290 | 1  | 150 |
| 4641-18-600     | 7314150383306 | 1  | 150 |
| 4641-20-400     | 7314150383313 | 1  | 150 |
| 4641-20-600     | 7314150383320 | 1  | 150 |
| 4641-22-400     | 7314150383337 | 1  | 150 |
| 4641-24-400     | 7314150383344 | 1  | 150 |
| 4641-25-400     | 7314150383351 | 1  | 150 |
| 4641-3-60       | 7314150382859 | 1  | 150 |
| 4641-4-75       | 7314150382866 | 1  | 150 |
| 4641-5-150      | 7314150382880 | 1  | 150 |
| 4641-5-85       | 7314150382873 | 1  | 150 |
| 4641-5.5-85     | 7314150382897 | 1  | 150 |
| 4641-6-100      | 7314150383016 | 1  | 150 |
| 4641-6-150      | 7314150383023 | 1  | 150 |
| 4641-6-400      | 7314150383184 | 1  | 150 |
| 4641-6.5-100    | 7314150383030 | 1  | 150 |
| 4641-7-100      | 7314150383047 | 1  | 150 |
| 4641-8-120      | 7314150383054 | 1  | 150 |
| 4641-8-200      | 7314150383061 | 1  | 150 |
| 4641-8-400      | 7314150383191 | 1  | 150 |
| 4641-9-120      | 7314150383078 | 1  | 150 |
| 4641-PB         | 7314150383368 | 1  | 150 |
| 4643-PB         | 7314150441679 | 1  | 150 |
| 4651-10-1000    | 7314150386413 | 1  | 149 |
| 4651-10-110     | 7314150386345 | 1  | 149 |
| 4651-10-160     | 7314150386352 | 1  | 149 |
| 4651-10-160-10P | 7314150475483 | 1  | 149 |
| 4651-10-210     | 7314150386369 | 1  | 149 |
| 4651-10-210-10P | 7314150475513 | 1  | 149 |
| 4651-10-260     | 7314150386376 | 1  | 149 |
| 4651-10-310     | 7314150386383 | 1  | 149 |
| 4651-10-450     | 7314150386390 | 1  | 149 |
| 4651-10-600     | 7314150386406 | 1  | 149 |
| 4651-12-1000    | 7314150386581 | 1  | 149 |
| 4651-12-160     | 7314150386529 | 1  | 149 |
| 4651-12-160-10P | 7314150475490 | 1  | 149 |
| 4651-12-210     | 7314150386536 | 1  | 149 |
| 4651-12-210-10P | 7314150475520 | 1  | 149 |
| 4651-12-260     | 7314150386543 | 1  | 149 |
| 4651-12-310     | 7314150386550 | 1  | 149 |
| 4651-12-450     | 7314150386567 | 1  | 149 |
| 4651-12-600     | 7314150386574 | 1  | 149 |
| 4651-14-1000    | 7314150386659 | 1  | 149 |
| 4651-14-160     | 7314150386598 | 1  | 149 |
| 4651-14-210     | 7314150386604 | 1  | 149 |
| 4651-14-260     | 7314150386611 | 1  | 149 |
| 4651-14-310     | 7314150386628 | 1  | 149 |
| 4651-14-450     | 7314150386635 | 1  | 149 |
| 4651-14-600     | 7314150386642 | 1  | 149 |
| 4651-15-160     | 7314150386666 | 1  | 149 |
| 4651-15-260     | 7314150386673 | 1  | 149 |
| 4651-15-450     | 7314150386680 | 1  | 149 |
| 4651-16-1000    | 7314150386765 | 1  | 149 |
| 4651-16-160     | 7314150386697 | 1  | 149 |
| 4651-16-210     | 7314150386710 | 1  | 149 |
| 4651-16-260     | 7314150386727 | 1  | 149 |
| 4651-16-310     | 7314150386734 | 1  | 149 |
| 4651-16-450     | 7314150386741 | 1  | 149 |
| 4651-16-600     | 7314150386758 | 1  | 149 |
| 4651-18-250     | 7314150386789 | 1  | 149 |
| 4651-18-450     | 7314150386796 | 1  | 149 |
| 4651-20-250     | 7314150386802 | 1  | 149 |



|                  |               |    |     |
|------------------|---------------|----|-----|
| 4651-20-450      | 7314150386819 | 1  | 149 |
| 4651-22-250      | 7314150386826 | 1  | 149 |
| 4651-22-450      | 7314150386833 | 1  | 149 |
| 4651-24-250      | 7314150386840 | 1  | 149 |
| 4651-24-450      | 7314150386857 | 1  | 149 |
| 4651-25-250      | 7314150386864 | 1  | 149 |
| 4651-25-450      | 7314150386871 | 1  | 149 |
| 4651-28-250      | 7314150386888 | 1  | 149 |
| 4651-28-450      | 7314150386895 | 1  | 149 |
| 4651-30-250      | 7314150386901 | 1  | 149 |
| 4651-30-450      | 7314150386918 | 1  | 149 |
| 4651-32-450      | 7314150386925 | 1  | 149 |
| 4651-5-110       | 7314150385683 | 1  | 149 |
| 4651-5-110-10P   | 7314150475407 | 1  | 149 |
| 4651-5-160       | 7314150385690 | 1  | 149 |
| 4651-5-160-10P   | 7314150475438 | 1  | 149 |
| 4651-5-260       | 7314150385713 | 1  | 149 |
| 4651-5.5-110     | 7314150385720 | 1  | 149 |
| 4651-5.5-110-10P | 7314150475414 | 10 | 149 |
| 4651-5.5-160     | 7314150385737 | 1  | 149 |
| 4651-5.5-160-10P | 7314150475445 | 1  | 149 |
| 4651-6-110       | 7314150385744 | 1  | 149 |
| 4651-6-110-10P   | 7314150475421 | 1  | 149 |
| 4651-6-160       | 7314150385751 | 1  | 149 |
| 4651-6-160-10P   | 7314150475452 | 1  | 149 |
| 4651-6-210       | 7314150385768 | 1  | 149 |
| 4651-6-260       | 7314150385775 | 1  | 149 |
| 4651-6-310       | 7314150385782 | 1  | 149 |
| 4651-6.5-110     | 7314150475391 | 50 | 149 |
| 4651-6.5-160     | 7314150385799 | 1  | 149 |
| 4651-6.5-160-10P | 7314150475469 | 1  | 149 |
| 4651-6.5-210     | 7314150385805 | 1  | 149 |
| 4651-6.5-260     | 7314150385812 | 1  | 149 |
| 4651-6.5-310     | 7314150385829 | 1  | 149 |
| 4651-7-110       | 7314150385836 | 1  | 149 |
| 4651-7-160       | 7314150386253 | 1  | 149 |
| 4651-8-110       | 7314150386277 | 1  | 149 |
| 4651-8-160       | 7314150386284 | 1  | 149 |
| 4651-8-160-10P   | 7314150475476 | 1  | 149 |
| 4651-8-210       | 7314150386291 | 1  | 149 |
| 4651-8-210-10P   | 7314150475506 | 1  | 149 |
| 4651-8-260       | 7314150386307 | 1  | 149 |
| 4651-8-310       | 7314150386314 | 1  | 149 |
| 4651-8-460       | 7314150386321 | 1  | 149 |
| 4651-SET-5       | 7314150475537 | 1  | 149 |
| 4651-SET-7       | 7314150475544 | 1  | 149 |
| 4652-10-110      | 7314150385119 | 1  | 149 |
| 4652-10-160      | 7314150385126 | 1  | 149 |
| 4652-10-160-10P  | 7314150475322 | 1  | 149 |
| 4652-10-210      | 7314150385133 | 1  | 149 |
| 4652-10-210-10P  | 7314150475353 | 1  | 149 |
| 4652-10-260      | 7314150385140 | 1  | 149 |
| 4652-10-310      | 7314150385164 | 1  | 149 |
| 4652-10-450      | 7314150385171 | 1  | 149 |
| 4652-10-600      | 7314150385188 | 1  | 149 |
| 4652-11-160      | 7314150385195 | 1  | 149 |
| 4652-11-260      | 7314150385218 | 1  | 149 |
| 4652-12-1000     | 7314150385287 | 1  | 150 |
| 4652-12-160      | 7314150385225 | 1  | 149 |
| 4652-12-160-10P  | 7314150475339 | 1  | 149 |
| 4652-12-210      | 7314150385232 | 1  | 149 |
| 4652-12-210-10P  | 7314150475360 | 1  | 149 |
| 4652-12-260      | 7314150385249 | 1  | 149 |
| 4652-12-310      | 7314150385256 | 1  | 149 |
| 4652-12-450      | 7314150385263 | 1  | 150 |
| 4652-12-600      | 7314150385270 | 1  | 150 |
| 4652-13-310      | 7314150385300 | 1  | 150 |
| 4652-14-1000     | 7314150385379 | 1  | 150 |
| 4652-14-160      | 7314150385317 | 1  | 150 |
| 4652-14-210      | 7314150385324 | 1  | 150 |
| 4652-14-260      | 7314150385331 | 1  | 150 |
| 4652-14-310      | 7314150385348 | 1  | 150 |
| 4652-14-450      | 7314150385355 | 1  | 150 |
| 4652-14-600      | 7314150385362 | 1  | 150 |
| 4652-15-260      | 7314150385393 | 1  | 150 |
| 4652-16-1000     | 7314150385478 | 1  | 150 |
| 4652-16-210      | 7314150385416 | 1  | 150 |
| 4652-16-260      | 7314150385423 | 1  | 150 |
| 4652-16-310      | 7314150385430 | 1  | 150 |
| 4652-16-450      | 7314150385447 | 1  | 150 |
| 4652-16-600      | 7314150385454 | 1  | 150 |
| 4652-18-1000     | 7314150385515 | 1  | 150 |
| 4652-18-200      | 7314150385485 | 1  | 150 |
| 4652-18-300      | 7314150385492 | 1  | 150 |
| 4652-18-450      | 7314150385508 | 1  | 150 |
| 4652-20-1000     | 7314150385560 | 1  | 150 |
| 4652-20-200      | 7314150385522 | 1  | 150 |
| 4652-20-300      | 7314150385539 | 1  | 150 |
| 4652-20-450      | 7314150385546 | 1  | 150 |
| 4652-20-600      | 7314150385553 | 1  | 150 |
| 4652-22-1000     | 7314150385607 | 1  | 150 |
| 4652-22-250      | 7314150385577 | 1  | 150 |
| 4652-22-450      | 7314150385584 | 1  | 150 |
| 4652-22-600      | 7314150385591 | 1  | 150 |
| 4652-24-250      | 7314150385614 | 1  | 150 |
| 4652-24-450      | 7314150385621 | 1  | 150 |





|                  |               |    |     |
|------------------|---------------|----|-----|
| 4652-25-1000     | 7314150385652 | 1  | 150 |
| 4652-25-250      | 7314150385638 | 1  | 150 |
| 4652-25-450      | 7314150385645 | 1  | 150 |
| 4652-26-250      | 7314150385669 | 1  | 150 |
| 4652-26-450      | 7314150385676 | 1  | 150 |
| 4652-3-110       | 7314150475216 | 50 | 149 |
| 4652-3,5-110     | 7314150475223 | 50 | 149 |
| 4652-4-110       | 7314150384365 | 1  | 149 |
| 4652-4-160       | 7314150384372 | 1  | 149 |
| 4652-5-110       | 7314150384815 | 1  | 149 |
| 4652-5-110-10P   | 7314150475247 | 1  | 149 |
| 4652-5-160       | 7314150384839 | 1  | 149 |
| 4652-5-160-10P   | 7314150475278 | 1  | 149 |
| 4652-5-210       | 7314150384846 | 1  | 149 |
| 4652-5,5-110     | 7314150384853 | 1  | 149 |
| 4652-5,5-110-10P | 7314150475254 | 10 | 149 |
| 4652-5,5-160     | 7314150384860 | 1  | 149 |
| 4652-5,5-160-10P | 7314150475285 | 1  | 149 |
| 4652-5,5-210     | 7314150475230 | 50 | 149 |
| 4652-6-110       | 7314150384877 | 1  | 149 |
| 4652-6-110-10P   | 7314150475261 | 1  | 149 |
| 4652-6-160       | 7314150384891 | 50 | 149 |
| 4652-6-160-10P   | 7314150475292 | 1  | 149 |
| 4652-6-210       | 7314150384907 | 1  | 149 |
| 4652-6-260       | 7314150384969 | 1  | 149 |
| 4652-6,5-110     | 7314150384976 | 1  | 149 |
| 4652-6,5-160     | 7314150384990 | 1  | 149 |
| 4652-6,5-160-10P | 7314150475308 | 1  | 149 |
| 4652-7-110       | 7314150385003 | 1  | 149 |
| 4652-7-160       | 7314150391981 | 1  | 149 |
| 4652-8-110       | 7314150385034 | 1  | 149 |
| 4652-8-160       | 7314150385058 | 1  | 149 |
| 4652-8-160-10P   | 7314150475315 | 1  | 149 |
| 4652-8-210       | 7314150385065 | 1  | 149 |
| 4652-8-210-10P   | 7314150475346 | 1  | 149 |
| 4652-8-260       | 7314150385072 | 1  | 149 |
| 4652-8-460       | 7314150385089 | 1  | 149 |
| 4652-9-160       | 7314150385096 | 1  | 149 |
| 4652-9-210       | 7314150385102 | 1  | 149 |
| 4652-SET-5       | 7314150475377 | 1  | 150 |
| 4652-SET-7       | 7314150475384 | 1  | 150 |
| 4655-FLAT-250    | 7314150387823 | 1  | 151 |
| 4655-HOLLOW-240  | 7314150387847 | 1  | 151 |
| 4655-POINT-250   | 7314150387816 | 1  | 151 |
| 4655-SLOT-25032  | 7314150387885 | 1  | 151 |
| 4655-TILE-20040  | 7314150387861 | 1  | 151 |
| 4655-WIDE-20040  | 7314150387830 | 1  | 151 |
| 4655-WING-C-250  | 7314150387854 | 1  | 151 |
| 4656-12-340      | 7314150386932 | 1  | 148 |
| 4656-12-540      | 7314150387021 | 1  | 148 |
| 4656-14-340      | 7314150387069 | 1  | 148 |
| 4656-14-540      | 7314150387076 | 1  | 148 |
| 4656-15-340      | 7314150387083 | 1  | 148 |
| 4656-16-1320     | 7314150387137 | 1  | 148 |
| 4656-16-340      | 7314150387106 | 1  | 148 |
| 4656-16-540      | 7314150387113 | 1  | 148 |
| 4656-16-940      | 7314150387120 | 1  | 148 |
| 4656-18-1320     | 7314150387175 | 1  | 148 |
| 4656-18-340      | 7314150387144 | 1  | 148 |
| 4656-18-540      | 7314150387151 | 1  | 148 |
| 4656-18-940      | 7314150387168 | 1  | 148 |
| 4656-20-1320     | 7314150387212 | 1  | 148 |
| 4656-20-320      | 7314150387182 | 1  | 148 |
| 4656-20-520      | 7314150387199 | 1  | 148 |
| 4656-20-920      | 7314150387205 | 1  | 148 |
| 4656-22-1320     | 7314150387250 | 1  | 148 |
| 4656-22-320      | 7314150387229 | 1  | 148 |
| 4656-22-520      | 7314150387236 | 1  | 148 |
| 4656-22-920      | 7314150387243 | 1  | 148 |
| 4656-24-320      | 7314150387267 | 1  | 148 |
| 4656-24-520      | 7314150387274 | 1  | 148 |
| 4656-25-1320     | 7314150387311 | 1  | 148 |
| 4656-25-320      | 7314150387281 | 1  | 148 |
| 4656-25-520      | 7314150387298 | 1  | 148 |
| 4656-25-920      | 7314150387304 | 1  | 148 |
| 4656-26-520      | 7314150387328 | 1  | 148 |
| 4656-28-370      | 7314150387434 | 1  | 148 |
| 4656-28-570      | 7314150387458 | 1  | 148 |
| 4656-28-670      | 7314150387489 | 1  | 148 |
| 4656-28-920      | 7314150387526 | 1  | 148 |
| 4656-30-370      | 7314150387540 | 1  | 148 |
| 4656-30-570      | 7314150387571 | 1  | 148 |
| 4656-32-1320     | 7314150387649 | 1  | 148 |
| 4656-32-370      | 7314150387595 | 1  | 148 |
| 4656-32-570      | 7314150387618 | 1  | 148 |
| 4656-32-920      | 7314150387632 | 1  | 148 |
| 4656-35-370      | 7314150387656 | 1  | 148 |
| 4656-35-570      | 7314150387663 | 1  | 148 |
| 4656-35-670      | 7314150387670 | 1  | 148 |
| 4656-37-370      | 7314150387687 | 1  | 148 |
| 4656-37-570      | 7314150387694 | 1  | 148 |
| 4656-37-920      | 7314150387700 | 1  | 148 |
| 4656-38-370      | 7314150387717 | 1  | 148 |
| 4656-38-570      | 7314150387724 | 1  | 148 |
| 4656-40-1320     | 7314150387762 | 1  | 148 |
| 4656-40-370      | 7314150387731 | 1  | 148 |



|                 |               |     |     |
|-----------------|---------------|-----|-----|
| 4656-40-570     | 7314150387748 | 1   | 148 |
| 4656-40-920     | 7314150387755 | 1   | 148 |
| 4656-45-570     | 7314150387779 | 1   | 148 |
| 4656-45-920     | 7314150387786 | 1   | 148 |
| 4656-50-570     | 7314150387793 | 1   | 148 |
| 4656-52-570     | 7314150387809 | 1   | 148 |
| 4659-FLAT -28   | 7314150387922 | 1   | 151 |
| 4659-FLAT -40   | 7314150387939 | 1   | 151 |
| 4659-FLAT -60   | 7314150387946 | 1   | 151 |
| 4659-POINT-28   | 7314150387892 | 1   | 151 |
| 4659-POINT-40   | 7314150387908 | 1   | 151 |
| 4659-POINT-60   | 7314150387915 | 1   | 151 |
| 4659-TILE-30-5  | 7314150388042 | 1   | 151 |
| 4659-TILE-30-8  | 7314150388059 | 1   | 151 |
| 4659-WIDE-30-8  | 7314150387953 | 1   | 151 |
| 4659-WIDE-36-5  | 7314150387984 | 1   | 151 |
| 466-1000        | 7314150128327 | 4   | 539 |
| 466-1000-M      | 7314150186105 | 4   | 539 |
| 466-1200        | 7314150128334 | 4   | 539 |
| 466-1200-M      | 7314150186129 | 4   | 539 |
| 466-1800        | 7314150128341 | 4   | 539 |
| 466-2000        | 7314150129836 | 4   | 539 |
| 466-250         | 7314150128655 | 10  | 541 |
| 466-400         | 7314150128297 | 4   | 539 |
| 466-400-M       | 7314150128358 | 4   | 539 |
| 466-600         | 7314150128303 | 4   | 539 |
| 466-600-M       | 7314150128365 | 4   | 539 |
| 466-800         | 7314150128310 | 4   | 539 |
| 466-800-M       | 7314150186082 | 4   | 539 |
| 466-BE1         | 7314150215218 | 12  | 541 |
| 466-LINE        | 7314150215249 | 12  | 541 |
| 466-POST        | 7314150215232 | 6   | 541 |
| 4724-JT         | 7311518265847 | 1   | 635 |
| 4728-JT         | 7311518265854 | 1   | 635 |
| 474-125-0.60    | 7311518029050 | 10  | 549 |
| 474-125-0.80    | 7311518029869 | 10  | 549 |
| 474-150-0.60    | 7311518029876 | 10  | 549 |
| 474-150-0.80    | 7311518029883 | 10  | 549 |
| 4750-2PP-1      | 7314153014733 | 1   | 469 |
| 4750-3PB-2      | 7314150187782 | 1   | 474 |
| 4750-BWC-1      | 7314153018809 | 1   | 469 |
| 4750-DHO-3      | 7314150289530 | 1   | 469 |
| 4750-EP-1       | 7314153014726 | 1   | 469 |
| 4750-FOLTC-1    | 7314153019271 | 1   | 467 |
| 4750-HDB-2      | 7314150289486 | 1   | 468 |
| 4750-HDBS-2     | 7314150289479 | 1   | 468 |
| 4750-HDLB-1     | 7314153014757 | 1   | 468 |
| 4750-HDLB-TAH   | 7314150303892 | 1   | 474 |
| 4750-HHO-2      | 7314153014863 | 1   | 474 |
| 4750-JU3PB-1    | 7314153015747 | 1   | 468 |
| 4750-KNHO-1     | 7314153015839 | 1   | 469 |
| 4750-KP-1       | 7314153014771 | 1   | 469 |
| 4750-LV-1       | 7314150358052 | 1   | 467 |
| 4750-LV-2       | 7314150393800 | 1   | 467 |
| 4750-MPH-1      | 7314150291625 | 1   | 469 |
| 4750-QRFB-1     | 7314150289455 | 1   | 468 |
| 4750-ROCO-1     | 7314153015273 | 1   | 469 |
| 4750-TOCST-1    | 7314153018779 | 1   | 467 |
| 4750-UP-2       | 7314150187768 | 1   | 474 |
| 4750-VDEC       | 7314150223377 | 1   | 468 |
| 4750-VMPH-1     | 7314153014818 | 1   | 469 |
| 4750ALC01FF1    | 7314150508884 | 1   | 440 |
| 4750BMC10       | 7314150264032 | 1   | 463 |
| 4750BMC10FF1    | 7314150500673 | 1   | 462 |
| 4750BMC3        | 7314150359639 | 1   | 463 |
| 4750BMC4        | 7314150426256 | 1   | 463 |
| 4750BMC5        | 7314150264001 | 1   | 463 |
| 4750BMC5,5      | 7314150326167 | 1   | 463 |
| 4750BMC6        | 7314150264018 | 1   | 463 |
| 4750BMC7        | 7314150277605 | 1   | 463 |
| 4750BMC9        | 7314150264025 | 1   | 463 |
| 4750BMC9,5      | 7314150326174 | 1   | 463 |
| 4750BMC11       | 7314150541294 | 1   | 121 |
| 4750FB1-19A     | 7314150277612 | 1   | 466 |
| 4750FB1-19B     | 7314150277629 | 4   | 466 |
| 4750FB2-19A     | 7314150277636 | 4   | 466 |
| 4750FB2-19TS001 | 7314150302772 | 1   | 463 |
| 4750FB2-24A     | 7314150277643 | 2   | 466 |
| 4750FB2W-24A    | 7314150277650 | 1   | 466 |
| 4750FB2W-TS001  | 7314150302765 | 1   | 463 |
| 4750FB3-12      | 7314150277667 | 1   | 466 |
| 4750FB4-18      | 7314150277674 | 4   | 466 |
| 4750FB4-18TS001 | 7314150302758 | 1   | 464 |
| 4750FB5-FG1     | 7314150401796 | 1   | 467 |
| 4750FB5-FG2     | 7314150401819 | 1   | 467 |
| 4750FB5A        | 7314150277704 | 1   | 467 |
| 4750FB5ATS001   | 7314150302727 | 1   | 465 |
| 4750FB5B        | 7314150277698 | 1   | 467 |
| 4750FB5BFF1     | 7314150302734 | 1   | 465 |
| 4750FB5C        | 7314150277681 | 8   | 467 |
| 4750FB6-13      | 7314150393091 | 1   | 466 |
| 4750FB6-19      | 7314150393114 | 1   | 467 |
| 4750FB7-01      | 7314150465668 | 60  | 468 |
| 4750FB7-02      | 7314150465675 | 60  | 468 |
| 4750FB7ORBG     | 7314150465682 | 120 | 468 |
| 4750FB7ORLT     | 7314150465699 | 120 | 468 |





# 4750FB8



|                 |               |   |     |
|-----------------|---------------|---|-----|
| 4750FB8         | 7314150465651 | 4 | 465 |
| 4750PTB50       | 7314150275007 | 3 | 463 |
| 4750PTB60       | 7314150275014 | 3 | 463 |
| 4750PTB65       | 7314150345809 | 2 | 463 |
| 4750PTB65TS5    | 7314150456260 | 1 | 462 |
| 4750PTBW47      | 7314150275021 | 1 | 462 |
| 4750PTBW67      | 7314150289189 | 1 | 462 |
| 4750RC01        | 7314150220151 | 1 | 443 |
| 4750RC02        | 7314150220168 | 1 | 443 |
| 4750RC021       | 7314150226641 | 1 | 443 |
| 4750RCHD-AC1    | 7314150229857 | 1 | 444 |
| 4750RCHD00      | 7314150271603 | 1 | 443 |
| 4750RCHD01      | 7314150227426 | 1 | 442 |
| 4750RCHD011     | 7314150229802 | 1 | 443 |
| 4750RCHD01AC1   | 7314150229819 | 1 | 444 |
| 4750RCHD01AC2   | 7314150229826 | 1 | 444 |
| 4750RCHD01FF1   | 7314150247578 | 1 | 440 |
| 4750RCHDW01     | 7314150227433 | 1 | 442 |
| 4750RCHDW01AC1  | 7314150229833 | 1 | 444 |
| 4750RCHDW01AC2  | 7314150229840 | 1 | 444 |
| 4750RCHDW01FF1  | 7314150247561 | 1 | 439 |
| 4750RCHDW01FF2  | 7314150249183 | 1 | 439 |
| 4750RCHDW01FF3  | 7314150249190 | 1 | 439 |
| 4750RCHDW01FF4  | 7314150309580 | 1 | 440 |
| 4750RCHDW01FF9  | 7314150345533 | 1 | 440 |
| 4750RCHDW01RED  | 7314150407538 | 1 | 442 |
| 4750RCHDW02     | 7314150227440 | 1 | 442 |
| 4750RCHDW02FF1  | 7314150267422 | 1 | 437 |
| 4750RCHDW02FF15 | 7314150347698 | 1 | 439 |
| 4750RCHDW02FF2  | 7314150306787 | 1 | 438 |
| 4750RCHDW02FF4  | 7314150309559 | 1 | 438 |
| 4750RCHDW02RED  | 7314150407545 | 1 | 442 |
| 4750RCHDW02RF1V | 7314150422081 | 1 | 437 |
| 4750RCHDW10     | 7314150425587 | 1 | 442 |
| 4750RCW01       | 7314150220182 | 1 | 443 |
| 4750RCW011      | 7314150226627 | 1 | 443 |
| 4750RCWD-AC1    | 7314150277179 | 1 | 443 |
| 4750RCWD-AC2    | 7314150277186 | 1 | 443 |
| 4750RCWD-AC3    | 7314150277193 | 1 | 443 |
| 4750RCWD-AC4    | 7314150277209 | 1 | 443 |
| 4750RCWD4       | 7314150277124 | 1 | 442 |
| 4750RCWD4-OR    | 7314150409501 | 1 | 442 |
| 4750RCWD4FF1    | 7314150302413 | 1 | 436 |
| 479-08          | 7311518025441 | 6 | 593 |
| 479-12          | 7311518025458 | 6 | 593 |
| 479-16          | 7311518025465 | 6 | 593 |
| 479-20          | 7314150319862 | 6 | 593 |
| 479-24          | 7311518025472 | 6 | 593 |
| 479-32          | 7311518025489 | 6 | 593 |
| 479F-08         | 7314150441952 | 6 | 593 |
| 479F-12         | 7314150441976 | 6 | 593 |
| 479F-16         | 7314150441983 | 6 | 593 |
| 479F-20         | 7314150441990 | 6 | 593 |
| 479F-24         | 7314150442003 | 6 | 593 |
| 479F-32         | 7314150442010 | 6 | 593 |
| 480-08          | 7311518025496 | 4 | 594 |
| 480-10          | 7311518025502 | 6 | 594 |
| 480-12          | 7311518025519 | 6 | 594 |
| 480-14          | 7311518025526 | 4 | 594 |
| 480-20          | 7314150319763 | 4 | 594 |
| 481-100         | 7311518005030 | 6 | 593 |
| 481-1000        | 7311518005092 | 6 | 593 |
| 481-1500        | 7311518025533 | 6 | 593 |
| 481-200         | 7311518005047 | 6 | 593 |
| 481-2000        | 7314150319855 | 6 | 593 |
| 481-300         | 7311518005054 | 6 | 593 |
| 481-400         | 7311518005061 | 6 | 593 |
| 481-500         | 7311518005078 | 6 | 593 |
| 481-800         | 7311518025540 | 6 | 593 |
| 481F-100        | 7314150442072 | 6 | 593 |
| 481F-1000       | 7314150442133 | 6 | 593 |
| 481F-1500       | 7314150442140 | 4 | 593 |
| 481F-200        | 7314150442089 | 4 | 593 |
| 481F-2000       | 7314150442157 | 4 | 593 |
| 481F-300        | 7314150442096 | 6 | 593 |
| 481F-400        | 7314150442102 | 6 | 593 |
| 481F-500        | 7314150442119 | 6 | 593 |
| 481F-800        | 7314150442126 | 6 | 593 |
| 482-25          | 7311518025557 | 6 | 593 |
| 482-28          | 7311518025564 | 6 | 593 |
| 482-30          | 7311518025571 | 6 | 593 |
| 482-35          | 7311518025595 | 6 | 593 |
| 482-40          | 7311518025601 | 6 | 593 |
| 482-45          | 7311518027551 | 6 | 593 |
| 482F-25         | 7314150442225 | 4 | 593 |
| 482F-28         | 7314150442232 | 4 | 593 |
| 482F-30         | 7314150442249 | 6 | 593 |
| 482F-35         | 7314150442256 | 4 | 593 |
| 482F-40         | 7314150442263 | 2 | 593 |
| 482F-45         | 7314150442270 | 4 | 593 |
| 483-16          | 7311518024314 | 6 | 594 |
| 483-20          | 7311518024321 | 6 | 594 |
| 483-22          | 7311518005108 | 6 | 594 |
| 483-25          | 7311518005115 | 6 | 594 |
| 483-28          | 7311518024284 | 6 | 594 |
| 4830            | 7314150100057 | 3 | 242 |



|               |               |    |     |
|---------------|---------------|----|-----|
| 4831          | 7314150103393 | 3  | 242 |
| 4833          | 7314150100064 | 3  | 243 |
| 483F-16       | 7314150442164 | 6  | 594 |
| 483F-20       | 7314150442171 | 6  | 594 |
| 483F-22       | 7314150442188 | 6  | 594 |
| 483F-25       | 7314150442195 | 6  | 594 |
| 483F-28       | 7314150442201 | 6  | 594 |
| 483F-30       | 7314150442218 | 4  | 594 |
| 484-1000      | 7311518005122 | 6  | 594 |
| 484-1250      | 7311518005139 | 6  | 594 |
| 484-1500      | 7311518005146 | 6  | 594 |
| 484-2000      | 7311518024338 | 4  | 594 |
| 484F-1000     | 7314150442027 | 6  | 594 |
| 484F-1250     | 7314150442034 | 6  | 594 |
| 484F-1500     | 7314150442041 | 6  | 594 |
| 484F-2000     | 7314150442058 | 4  | 594 |
| 485           | 7311518005153 | 6  | 594 |
| 485W-650      | 7314150319770 | 6  | 594 |
| 485W-750      | 7314150319787 | 6  | 594 |
| 486           | 7311518005160 | 4  | 595 |
| 486-1800      | 7314150315307 | 5  | 541 |
| 486-1800WH    | 7314150315338 | 5  | 541 |
| 486-2000      | 7314150315314 | 5  | 541 |
| 486-2000WH    | 7314150315345 | 5  | 541 |
| 486-2400      | 7314150315321 | 5  | 541 |
| 486-2400WH    | 7314150315352 | 5  | 541 |
| 486-700       | 7314150338078 | 6  | 595 |
| 486F-700      | 7314150338085 | 6  | 595 |
| 486W-500      | 7314150319794 | 4  | 595 |
| 486W-600      | 7314150319800 | 4  | 595 |
| 488-2000      | 7314150337972 | 2  | 595 |
| 488-3000      | 7314150337989 | 2  | 595 |
| 488-4000      | 7314150337996 | 2  | 595 |
| 488-5000      | 7314150338009 | 2  | 595 |
| 488-6000      | 7314150338016 | 1  | 595 |
| 488F-2000     | 7314150338023 | 2  | 595 |
| 488F-3000     | 7314150338030 | 2  | 595 |
| 488F-4000     | 7314150338047 | 2  | 595 |
| 488F-5000     | 7314150338054 | 4  | 595 |
| 488F-6000     | 7314150338061 | 2  | 595 |
| 489-1100      | 7314150133055 | 8  | 597 |
| 489-1800      | 7314150133062 | 8  | 597 |
| 489-2700      | 7314150133079 | 4  | 597 |
| 489-3600      | 7314150133086 | 4  | 597 |
| 489-4500      | 7314150133093 | 4  | 597 |
| 489-5400      | 7314150133109 | 4  | 597 |
| 490-3.5       | 7311518025373 | 4  | 594 |
| 491-3000      | 7314150345199 | 4  | 597 |
| 491-4000      | 7314150345205 | 4  | 597 |
| 491-5000      | 7314150345212 | 4  | 597 |
| 491-6000      | 7314150345229 | 4  | 597 |
| 492-3.5       | 7311518025380 | 6  | 594 |
| 493-500       | 7314150338139 | 6  | 596 |
| 493-600       | 7314150338146 | 6  | 596 |
| 493F-500      | 7314150338153 | 6  | 596 |
| 493F-600      | 7314150338160 | 1  | 596 |
| 494-600       | 7311518025397 | 4  | 596 |
| 495-500       | 7314150338191 | 6  | 596 |
| 495-600       | 7314150338207 | 6  | 596 |
| 495F-500      | 7314150338184 | 6  | 596 |
| 495F-600      | 7314150338177 | 1  | 596 |
| 496-1500      | 7314150315147 | 5  | 541 |
| 496-1800      | 7314150315154 | 5  | 541 |
| 496-SPARE     | 7314150329304 | 1  | 542 |
| 4M-10-11      | 7314151829438 | 10 | 53  |
| 4M-12-13      | 7314151829445 | 10 | 53  |
| 4M-14-15      | 7314151829476 | 10 | 53  |
| 4M-16-17      | 7314151829490 | 10 | 53  |
| 4M-17-19      | 7314151829506 | 10 | 53  |
| 4M-18-19      | 7314151829513 | 10 | 53  |
| 4M-20-22      | 7314151829520 | 10 | 53  |
| 4M-21-23      | 7314150205363 | 5  | 53  |
| 4M-24-26      | 7314150205370 | 1  | 53  |
| 4M-24-27      | 7314151829551 | 1  | 53  |
| 4M-25-28      | 7314150205387 | 1  | 53  |
| 4M-27-29      | 7314150205394 | 1  | 53  |
| 4M-30-32      | 7314151829575 | 1  | 53  |
| 4M-6-7        | 7314151829407 | 10 | 53  |
| 4M-8-9        | 7314151829414 | 10 | 53  |
| 4M/10C        | 7314150212972 | 1  | 53  |
| 4M/10T        | 7314151829605 | 1  | 53  |
| 4M/12C        | 7314150212989 | 1  | 54  |
| 4M/8          | 7314150180493 | 1  | 54  |
| 5-600-21-D-1P | 7311518189341 | 10 | 35  |
| 5-610-21-D-1P | 7311518189358 | 5  | 35  |
| 5-630-21-D-1P | 7311518189365 | 1  | 35  |
| 5-670-21-D-1P | 7311518189389 | 1  | 35  |
| 500-12        | 7314150390977 | 1  | 270 |
| 500-14        | 7314150414505 | 1  | 270 |
| 500-15        | 7314150390984 | 1  | 270 |
| 500-16        | 7314150414512 | 1  | 270 |
| 500-18        | 7314150414543 | 1  | 270 |
| 500-22        | 7314150414567 | 1  | 270 |
| 502           | 7311518130589 | 25 | 566 |
| 502-SET2      | 7311518130664 | 35 | 566 |
| 502-SET6      | 7311518130633 | 10 | 566 |



|             |               |    |     |
|-------------|---------------|----|-----|
| 5050        | 7314151083359 | 1  | 360 |
| 51-12       | 7311518044565 | 10 | 634 |
| 51-21       | 7311518003906 | 10 | 634 |
| 51-24       | 7311518003913 | 10 | 634 |
| 51-30       | 7311518003920 | 10 | 634 |
| 51-32       | 7311518003937 | 10 | 634 |
| 51-36       | 7311518003944 | 10 | 634 |
| 510031      | 7314150216338 | 5  | 215 |
| 510033      | 7314150216345 | 5  | 215 |
| 510034      | 7314150216314 | 10 | 214 |
| 5124-JS-H   | 7311518219352 | 4  | 635 |
| 5128-JS-H   | 7311518219369 | 4  | 635 |
| 52          | 7311518276027 | 12 | 308 |
| 5226 DC     | 7314150120352 | 1  | 248 |
| 527 D-160   | 7314150032723 | 5  | 236 |
| 527 D-200   | 7314150032730 | 5  | 236 |
| 527 GC-160  | 7314150205653 | 3  | 236 |
| 527 GC-200  | 7314150205660 | 3  | 236 |
| 527V-160    | 7314150126811 | 2  | 499 |
| 527V-200    | 7314150126828 | 2  | 499 |
| 528-700     | 7311518188993 | 1  | 573 |
| 528-COM     | 7311518188986 | 1  | 573 |
| 529-16-L    | 7314150198139 | 4  | 592 |
| 529-16-XL   | 7314150198146 | 4  | 592 |
| 529-20-L    | 7314150198160 | 4  | 592 |
| 529-20-XL   | 7314150198153 | 4  | 592 |
| 529S-16-XL  | 7314150340330 | 4  | 592 |
| 529S-20-XL  | 7314150340347 | 4  | 592 |
| 541 D-150   | 7314150032754 | 5  | 237 |
| 541 D-200   | 7314150032761 | 5  | 237 |
| 541 D-250   | 7314150032778 | 5  | 237 |
| 5418        | 7314151084370 | 1  | 536 |
| 5419/6T     | 7314151821562 | 1  | 536 |
| 541D-180    | 7314150127160 | 5  | 237 |
| 541D-225    | 7314150127290 | 5  | 237 |
| 5463 R      | 7314151085063 | 5  | 534 |
| 5463-120    | 7314151085001 | 5  | 534 |
| 54640       | 7314150215720 | 1  | 169 |
| 5465 AMT    | 7314151085148 | 5  | 532 |
| 5465 R      | 7314151085162 | 5  | 534 |
| 5468-112    | 7314151085247 | 5  | 532 |
| 5469 B      | 7314151085322 | 5  | 532 |
| 5469 BI     | 7314151085346 | 5  | 532 |
| 5469 I      | 7314151085407 | 5  | 532 |
| 5469 R      | 7314151085421 | 5  | 532 |
| 5469-127    | 7314151085285 | 5  | 532 |
| 5470-120    | 7314151085452 | 5  | 534 |
| 5471 F-120  | 7314151085681 | 5  | 532 |
| 5471 F-145  | 7314151085704 | 5  | 532 |
| 5471 F-200  | 7314151085728 | 5  | 532 |
| 5471 F-250  | 7314151085742 | 5  | 532 |
| 5471 F-300  | 7314151085766 | 5  | 532 |
| 5471 FI-120 | 7314151085780 | 5  | 532 |
| 5471 FI-200 | 7314151085827 | 5  | 532 |
| 5471 FR-120 | 7314151085889 | 5  | 532 |
| 5471 FR-145 | 7314151085902 | 5  | 532 |
| 5475 K      | 7314151086244 | 5  | 532 |
| 5475 R      | 7314151086268 | 5  | 532 |
| 5476 H      | 7314151086305 | 5  | 534 |
| 5479-130    | 7314151086398 | 5  | 532 |
| 5488 AM     | 7314151821166 | 5  | 533 |
| 5489 AM     | 7314151821173 | 5  | 533 |
| 5490 AM     | 7314151821180 | 5  | 533 |
| 5493-115    | 7314151821234 | 5  | 534 |
| 5515B       | 7314151086978 | 25 | 361 |
| 5515FL      | 7314150504077 | 10 | 361 |
| 5515FUV     | 7314150540143 | 1  | 361 |
| 5515GV      | 7314151481483 | 1  | 360 |
| 5515L       | 7314151481568 | 1  | 361 |
| 5515M       | 7314151086985 | 1  | 361 |
| 5515T       | 7314151589172 | 25 | 361 |
| 5515T-52    | 7314153021939 | 25 | 360 |
| 5516        | 7314151086992 | 5  | 532 |
| 5516 I      | 7314151087029 | 5  | 532 |
| 5517        | 7314151573843 | 5  | 532 |
| 5517 I      | 7314151573928 | 5  | 532 |
| 5518        | 7314151087043 | 5  | 532 |
| 5521        | 7314150215713 | 1  | 169 |
| 5540 AM     | 7314151821319 | 5  | 532 |
| 5541 AM     | 7314151821326 | 5  | 533 |
| 5544 AM     | 7314151821357 | 5  | 533 |
| 5545 AM     | 7314151821364 | 5  | 533 |
| 5546 AM     | 7314151821371 | 5  | 533 |
| 5547 AM     | 7314151821388 | 5  | 533 |
| 5549 AM     | 7314151821401 | 5  | 533 |
| 5550-3.2    | 7314151475673 | 10 | 536 |
| 5550-4.5    | 7314151475758 | 10 | 536 |
| 5551        | 7314151378479 | 1  | 536 |
| 5552        | 7314151378554 | 1  | 536 |
| 5553        | 7314151378639 | 1  | 536 |
| 5554        | 7314151378714 | 1  | 536 |
| 5568/5      | 7314151821210 | 1  | 534 |
| 5573-145    | 7314151473112 | 5  | 533 |
| 5577-145    | 7314151574062 | 5  | 534 |
| 5578-115    | 7314151547769 | 5  | 533 |
| 5579-115    | 7314151547844 | 5  | 533 |



|                |               |     |     |
|----------------|---------------|-----|-----|
| 5588 AM        | 7314151821432 | 5   | 534 |
| 5589 AM        | 7314151821449 | 5   | 534 |
| 5590 AM        | 7314151821456 | 5   | 534 |
| 5600/4         | 7314151436773 | 1   | 536 |
| 5724-JS        | 7311518216085 | 1   | 635 |
| 5728-JS        | 7311518216092 | 1   | 635 |
| 5750           | 7311518280949 | 1   | 343 |
| 5770           | 7314150504466 | 12  | 343 |
| 583D           | 7314150023721 | 4   | 577 |
| 584D           | 7314150023745 | 4   | 577 |
| 585D           | 7314150104185 | 4   | 577 |
| 586D           | 7314150104208 | 4   | 577 |
| 59/S100BC      | 7314150337637 | 1   | 167 |
| 59/S100BC-IP   | 7314150337644 | 8   | 167 |
| 59/S10BC       | 7314150413003 | 1   | 165 |
| 59/S28-4       | 7314151847173 | 1   | 166 |
| 59/S31B        | 7314150325788 | 1   | 166 |
| 59/S31B-IP     | 7314150325795 | 12  | 166 |
| 59/S35BC       | 7314150412990 | 1   | 167 |
| 59/S36BCR      | 7314150413232 | 6   | 211 |
| 59/S54BC       | 7314150337613 | 1   | 167 |
| 59/S54BC-IP    | 7314150337620 | 8   | 167 |
| 59S/0.5-3.0    | 7314150199815 | 1   | 160 |
| 59S/0.5-3.0-3P | 7314150259205 | 1   | 160 |
| 59S/0.5-4.0    | 7314150199822 | 1   | 160 |
| 59S/0.5-4.0-3P | 7314150259212 | 1   | 160 |
| 59S/0.6-3.5    | 7314150199839 | 1   | 160 |
| 59S/0.6-3.5-3P | 7314150259229 | 1   | 160 |
| 59S/0.6-4.5    | 7314150198801 | 1   | 160 |
| 59S/0.6-4.5-3P | 7314150201600 | 1   | 160 |
| 59S/0.8-5.5    | 7314150198849 | 1   | 160 |
| 59S/0.8-5.5-3P | 7314150201624 | 1   | 160 |
| 59S/1.0-5.5    | 7314150198863 | 1   | 160 |
| 59S/1.0-5.5-3P | 7314150259963 | 1   | 160 |
| 59S/1.2-6.5    | 7314150198887 | 1   | 160 |
| 59S/1.2-6.5-3P | 7314150259970 | 1   | 160 |
| 59S/1.2-8.0    | 7314150198900 | 1   | 160 |
| 59S/1.2-8.0-3P | 7314150259987 | 1   | 160 |
| 59S/1.6-10     | 7314150199846 | 1   | 160 |
| 59S/1.6-10-3P  | 7314150259236 | 1   | 160 |
| 59S/1.6-9.0    | 7314150199853 | 1   | 160 |
| 59S/1.6-9.0-3P | 7314150259243 | 1   | 160 |
| 59S/125PH1     | 7314150206834 | 1   | 164 |
| 59S/125PH1-2P  | 7314150260553 | 1   | 164 |
| 59S/125PH2     | 7314150204298 | 1   | 164 |
| 59S/125PH2-2P  | 7314150260560 | 1   | 164 |
| 59S/125PH2-IP  | 7314150342433 | 100 | 164 |
| 59S/125PH3     | 7314150204304 | 1   | 164 |
| 59S/125PH3-2P  | 7314150260577 | 1   | 164 |
| 59S/125PZ1     | 7314150200733 | 1   | 164 |
| 59S/125PZ1-2P  | 7314150260522 | 1   | 164 |
| 59S/125PZ2     | 7314150200740 | 1   | 164 |
| 59S/125PZ2-2P  | 7314150260539 | 1   | 164 |
| 59S/125PZ3     | 7314150200757 | 1   | 164 |
| 59S/125PZ3-2P  | 7314150260546 | 1   | 164 |
| 59S/150T15     | 7314150200764 | 1   | 164 |
| 59S/150T15-2P  | 7314150260584 | 1   | 164 |
| 59S/150T20     | 7314150200771 | 1   | 164 |
| 59S/150T20-2P  | 7314150260591 | 1   | 164 |
| 59S/150T25     | 7314150200788 | 1   | 164 |
| 59S/150T25-2P  | 7314150260607 | 1   | 164 |
| 59S/150T30     | 7314150200795 | 1   | 164 |
| 59S/150T30-2P  | 7314150260614 | 1   | 164 |
| 59S/17-1       | 7314150191499 | 1   | 165 |
| 59S/17-2       | 7314150191505 | 1   | 166 |
| 59S/17-3       | 7314150191512 | 1   | 166 |
| 59S/22-1       | 7314150204229 | 1   | 166 |
| 59S/22-2       | 7314150204236 | 1   | 166 |
| 59S/31-1       | 7314150191451 | 1   | 166 |
| 59S/31-2       | 7314150191468 | 1   | 167 |
| 59S/31-3       | 7314150191475 | 1   | 167 |
| 59S/50/0.6-3.5 | 7314150199976 | 1   | 162 |
| 59S/50/0.8-4.0 | 7314150200009 | 1   | 162 |
| 59S/50/0.8-5.5 | 7314150200023 | 1   | 162 |
| 59S/50/1.0-6.0 | 7314150200047 | 1   | 162 |
| 59S/50/1.2-6.5 | 7314150200061 | 1   | 162 |
| 59S/50/3.5-2P  | 7314150260027 | 1   | 162 |
| 59S/50/4.0-2P  | 7314150260041 | 1   | 162 |
| 59S/50/5.5-2P  | 7314150260065 | 1   | 162 |
| 59S/50/6.0-2P  | 7314150260089 | 1   | 162 |
| 59S/50/6.5-2P  | 7314150260102 | 1   | 162 |
| 59S/50H1/16    | 7314150248926 | 1   | 163 |
| 59S/50H1/4     | 7314150249015 | 1   | 163 |
| 59S/50H1/8     | 7314150248964 | 1   | 163 |
| 59S/50H2       | 7314150200160 | 1   | 163 |
| 59S/50H2-2P    | 7314150259298 | 1   | 163 |
| 59S/50H2.5-5P  | 7314150531653 | 1   | 163 |
| 59S/50H2.5-2P  | 7314150259304 | 1   | 163 |
| 59S/50H3       | 7314150200184 | 1   | 163 |
| 59S/50H3-2P    | 7314150259335 | 1   | 163 |
| 59S/50H3/16    | 7314150248995 | 1   | 163 |
| 59S/50H3/32    | 7314150248940 | 1   | 163 |
| 59S/50H3/8     | 7314150249039 | 1   | 163 |
| 59S/50H4-5P    | 7314150531691 | 1   | 163 |
| 59S/50H4-2P    | 7314150259359 | 1   | 163 |
| 59S/50H5-5P    | 7314150531714 | 1   | 163 |



# 59S/50H5-2P



|                |               |   |     |
|----------------|---------------|---|-----|
| 59S/50H5-2P    | 7314150259373 | 1 | 163 |
| 59S/50H5/16    | 7314150249022 | 1 | 163 |
| 59S/50H5/32    | 7314150248988 | 1 | 163 |
| 59S/50H5/64    | 7314150248933 | 1 | 163 |
| 59S/50H6       | 7314150200214 | 1 | 163 |
| 59S/50H6-2P    | 7314150259397 | 1 | 163 |
| 59S/50H7/32    | 7314150249008 | 1 | 163 |
| 59S/50H7/64    | 7314150248957 | 1 | 163 |
| 59S/50H8-2P    | 7314150259410 | 1 | 163 |
| 59S/50H8-5P    | 7314150531752 | 1 | 163 |
| 59S/50H9/64    | 7314150248971 | 1 | 163 |
| 59S/50PH1      | 7314150199860 | 1 | 162 |
| 59S/50PH1-2P   | 7314150203642 | 1 | 162 |
| 59S/50PH2-5P   | 7314150531790 | 1 | 162 |
| 59S/50PH2-2P   | 7314150203758 | 1 | 162 |
| 59S/50PH3-2P   | 7314150203802 | 1 | 162 |
| 59S/50PH3-5P   | 7314150531813 | 1 | 162 |
| 59S/50PZ1-2P   | 7314150204007 | 1 | 163 |
| 59S/50PZ2-2P   | 7314150204014 | 1 | 163 |
| 59S/50PZ2-5P   | 7314150531851 | 1 | 163 |
| 59S/50PZ3-2P   | 7314150204021 | 1 | 163 |
| 59S/50PZ3-5P   | 7314150531875 | 1 | 163 |
| 59S/50R1       | 7314150200238 | 1 | 163 |
| 59S/50R1-2P    | 7314150259441 | 1 | 163 |
| 59S/50R2       | 7314150200245 | 1 | 163 |
| 59S/50R2-2P    | 7314150259472 | 1 | 163 |
| 59S/50R3       | 7314150200252 | 1 | 163 |
| 59S/50R3-2P    | 7314150259502 | 1 | 163 |
| 59S/50T10      | 7314150200092 | 1 | 163 |
| 59S/50T10-2P   | 7314150201723 | 1 | 163 |
| 59S/50T15      | 7314150200108 | 1 | 163 |
| 59S/50T15-2P   | 7314150201730 | 1 | 163 |
| 59S/50T20-5P   | 7314150531936 | 1 | 163 |
| 59S/50T20-2P   | 7314150201747 | 1 | 163 |
| 59S/50T25      | 7314150200122 | 1 | 163 |
| 59S/50T25-2P   | 7314150201754 | 1 | 163 |
| 59S/50T27      | 7314150200139 | 1 | 163 |
| 59S/50T30      | 7314150200146 | 1 | 163 |
| 59S/50T30-2P   | 7314150201761 | 1 | 163 |
| 59S/50T40      | 7314150200153 | 1 | 163 |
| 59S/50T40-2P   | 7314150259281 | 1 | 163 |
| 59S/50T8       | 7314150200085 | 1 | 163 |
| 59S/50T8-2P    | 7314150262809 | 1 | 163 |
| 59S/60PEN/DISP | 7314150459032 | 1 | 168 |
| 59S/7-1        | 7314150191536 | 1 | 165 |
| 59S/7-2        | 7314150191543 | 1 | 165 |
| 59S/7-3        | 7314150191550 | 1 | 165 |
| 59S/7-4        | 7314150191567 | 1 | 165 |
| 59S/70PH1-2P   | 7314150259526 | 1 | 163 |
| 59S/70PH2-2P   | 7314150259557 | 1 | 163 |
| 59S/70PH2-5P   | 7314150532032 | 1 | 163 |
| 59S/70PZ1      | 7314150200283 | 1 | 163 |
| 59S/70PZ1-2P   | 7314150259564 | 1 | 163 |
| 59S/70PZ2      | 7314150200290 | 1 | 163 |
| 59S/70PZ2-2P   | 7314150260331 | 1 | 163 |
| 59S/70PZ3      | 7314150200306 | 1 | 163 |
| 59S/70PZ3-2P   | 7314150260348 | 1 | 163 |
| 59S/70T10      | 7314150200313 | 1 | 163 |
| 59S/70T10-2P   | 7314150260355 | 1 | 163 |
| 59S/70T15      | 7314150200566 | 1 | 163 |
| 59S/70T15-2P   | 7314150260362 | 1 | 163 |
| 59S/70T20-2P   | 7314150201839 | 1 | 163 |
| 59S/70T20-5P   | 7314150532131 | 1 | 163 |
| 59S/70T25-2P   | 7314150260379 | 1 | 163 |
| 59S/70T25-5P   | 7314150532155 | 1 | 163 |
| 59S/70T27      | 7314150200597 | 1 | 163 |
| 59S/70T27-2P   | 7314150260386 | 1 | 163 |
| 59S/70T30-2P   | 7314150260393 | 1 | 163 |
| 59S/70T30-5P   | 7314150532179 | 1 | 163 |
| 59S/70T40      | 7314150200610 | 1 | 163 |
| 59S/70T40-2P   | 7314150260409 | 1 | 163 |
| 59S/70TR15     | 7314150200627 | 1 | 164 |
| 59S/70TR15-2P  | 7314150260416 | 1 | 164 |
| 59S/70TR20     | 7314150200634 | 1 | 164 |
| 59S/70TR20-2P  | 7314150260423 | 1 | 164 |
| 59S/70TR25     | 7314150200641 | 1 | 164 |
| 59S/70TR25-2P  | 7314150260430 | 1 | 164 |
| 59S/70TR27     | 7314150200658 | 1 | 164 |
| 59S/70TR27-2P  | 7314150260447 | 1 | 164 |
| 59S/70TR30     | 7314150200665 | 1 | 164 |
| 59S/70TR30-2P  | 7314150260454 | 1 | 164 |
| 59S/70TR40     | 7314150200672 | 1 | 164 |
| 59S/70TR40-2P  | 7314150260461 | 1 | 164 |
| 59S/H1.5       | 7314150198924 | 1 | 161 |
| 59S/H1.5-3P    | 7314150258994 | 1 | 161 |
| 59S/H1/16-3P   | 7314150259021 | 1 | 162 |
| 59S/H1/4       | 7314150199266 | 1 | 162 |
| 59S/H1/4-3P    | 7314150259120 | 1 | 162 |
| 59S/H1/8-3P    | 7314150259069 | 1 | 162 |
| 59S/H1/8-5P    | 7314150532254 | 1 | 162 |
| 59S/H10        | 7314150199075 | 1 | 161 |
| 59S/H10-3P     | 7311518333638 | 1 | 161 |
| 59S/H2         | 7314150198955 | 1 | 161 |
| 59S/H2-3P      | 7314150259007 | 1 | 161 |
| 59S/H2.5       | 7314150198962 | 1 | 161 |
| 59S/H2.5-3P    | 7314150259014 | 1 | 161 |



|                 |               |     |     |
|-----------------|---------------|-----|-----|
| 59S/H3          | 7314150198986 | 1   | 161 |
| 59S/H3-3P       | 7314150201662 | 1   | 161 |
| 59S/H3/16-3P    | 7314150259090 | 1   | 162 |
| 59S/H3/16-5P    | 7314150532353 | 1   | 162 |
| 59S/H3/32-3P    | 7314150259045 | 1   | 162 |
| 59S/H3/32-5P    | 7314150532377 | 1   | 162 |
| 59S/H3/8        | 7314150204212 | 1   | 162 |
| 59S/H3/8-3P     | 7314150259144 | 1   | 162 |
| 59S/H3BALL      | 7314150200689 | 1   | 164 |
| 59S/H3BALL-2P   | 7314150260478 | 1   | 164 |
| 59S/H4          | 7314150198993 | 1   | 161 |
| 59S/H4-3P       | 7314150201679 | 1   | 161 |
| 59S/H4-IPB      | 7314150225767 | 500 | 161 |
| 59S/H4BALL      | 7314150200696 | 1   | 164 |
| 59S/H4BALL-2P   | 7314150260485 | 1   | 164 |
| 59S/H5          | 7314150199013 | 1   | 161 |
| 59S/H5-3P       | 7314150201686 | 1   | 161 |
| 59S/H5/16-3P    | 7314150259137 | 1   | 162 |
| 59S/H5/16-5P    | 7314150532438 | 1   | 162 |
| 59S/H5/32-3P    | 7314150259083 | 1   | 162 |
| 59S/H5/32-5P    | 7314150532452 | 1   | 162 |
| 59S/H5/64-3P    | 7314150259038 | 1   | 162 |
| 59S/H5/64-5P    | 7314150532476 | 1   | 162 |
| 59S/H5BALL      | 7314150200702 | 1   | 164 |
| 59S/H5BALL-2P   | 7314150260492 | 1   | 164 |
| 59S/H6          | 7314150199037 | 1   | 161 |
| 59S/H6-3P       | 7314150201693 | 1   | 161 |
| 59S/H6BALL      | 7314150200719 | 1   | 164 |
| 59S/H6BALL-2P   | 7314150260508 | 1   | 164 |
| 59S/H7/32-3P    | 7314150259113 | 1   | 162 |
| 59S/H7/32-5P    | 7314150532513 | 1   | 162 |
| 59S/H7/64-3P    | 7314150259052 | 1   | 162 |
| 59S/H7/64-5P    | 7314150532537 | 1   | 162 |
| 59S/H8-3P       | 7314150201709 | 1   | 161 |
| 59S/H8-5P       | 7314150532551 | 1   | 161 |
| 59S/H8BALL      | 7314150200726 | 1   | 164 |
| 59S/H8BALL-2P   | 7314150260515 | 1   | 164 |
| 59S/H9/64-3P    | 7314150259076 | 1   | 162 |
| 59S/HBALL-3P    | 7314150201716 | 1   | 164 |
| 59S/M3          | 7314150199730 | 1   | 162 |
| 59S/M3-3P       | 7314150259151 | 1   | 162 |
| 59S/M4          | 7314150199754 | 1   | 162 |
| 59S/M4-3P       | 7314150259168 | 1   | 162 |
| 59S/M5          | 7314150199778 | 1   | 162 |
| 59S/M5-3P       | 7314150259175 | 1   | 162 |
| 59S/M6          | 7314150199792 | 1   | 162 |
| 59S/M6-3P       | 7314150259182 | 1   | 162 |
| 59S/M8          | 7314150199808 | 1   | 162 |
| 59S/M8-3P       | 7314150259199 | 1   | 162 |
| 59S/PH0         | 7314150198177 | 1   | 160 |
| 59S/PH0-3P      | 7314150258819 | 1   | 160 |
| 59S/PH1-30P     | 7314150200801 | 1   | 160 |
| 59S/PH1-3P      | 7314150201396 | 1   | 160 |
| 59S/PH1-IP      | 7314150206780 | 100 | 160 |
| 59S/PH1-IPB     | 7314150225743 | 500 | 160 |
| 59S/PH1COMBI-2P | 7314150215669 | 1   | 164 |
| 59S/PH2         | 7314150198320 | 1   | 160 |
| 59S/PH2-30P     | 7314150200818 | 1   | 160 |
| 59S/PH2-3P      | 7314150201402 | 1   | 160 |
| 59S/PH2-IP      | 7314150206797 | 100 | 160 |
| 59S/PH2-IPB     | 7314150204038 | 500 | 160 |
| 59S/PH2COMBI-2P | 7314150203604 | 1   | 164 |
| 59S/PH2G-30P    | 7314150200832 | 1   | 160 |
| 59S/PH2G-3P     | 7314150259250 | 1   | 160 |
| 59S/PH2PEN      | 7314150458950 | 1   | 168 |
| 59S/PH3-30P     | 7314150200825 | 1   | 160 |
| 59S/PH3-3P      | 7314150201419 | 1   | 160 |
| 59S/PH3-IPB     | 7314150225750 | 500 | 160 |
| 59S/PH3COMBI-2P | 7314150203611 | 1   | 164 |
| 59S/PH4         | 7314150198368 | 1   | 160 |
| 59S/PH4-3P      | 7314150258826 | 1   | 160 |
| 59S/PZ0         | 7314150198375 | 1   | 161 |
| 59S/PZ0-3P      | 7314150258833 | 1   | 161 |
| 59S/PZ1         | 7314150198382 | 1   | 161 |
| 59S/PZ1-30P     | 7314150200849 | 1   | 161 |
| 59S/PZ1-3P      | 7314150201426 | 1   | 161 |
| 59S/PZ1-IP      | 7314150206803 | 100 | 161 |
| 59S/PZ1-IPB     | 7314150204373 | 500 | 161 |
| 59S/PZ2-30P     | 7314150200856 | 1   | 161 |
| 59S/PZ2-3P      | 7314150201433 | 1   | 161 |
| 59S/PZ2-IP      | 7314150206810 | 100 | 161 |
| 59S/PZ2-IPB     | 7314150204380 | 500 | 161 |
| 59S/PZ2PEN      | 7314150458974 | 1   | 168 |
| 59S/PZ3         | 7314150198429 | 1   | 161 |
| 59S/PZ3-30P     | 7314150200863 | 1   | 161 |
| 59S/PZ3-3P      | 7314150201440 | 1   | 161 |
| 59S/PZ3-IPB     | 7314150225736 | 500 | 161 |
| 59S/PZ4         | 7314150198436 | 1   | 161 |
| 59S/R1          | 7314150199310 | 1   | 162 |
| 59S/R1-3P       | 7314150201631 | 1   | 162 |
| 59S/R2          | 7314150199341 | 1   | 162 |
| 59S/R2-3P       | 7314150201648 | 1   | 162 |
| 59S/R3          | 7314150199365 | 1   | 162 |
| 59S/R3-3P       | 7314150201655 | 1   | 162 |
| 59S/R4          | 7314150232109 | 1   | 162 |
| 59S/T10         | 7314150198528 | 1   | 161 |



|              |               |    |     |
|--------------|---------------|----|-----|
| 59S/T10-30P  | 7314150200870 | 1  | 161 |
| 59S/T10-3P   | 7314150201457 | 1  | 161 |
| 59S/T10CS    | 7314150444014 | 1  | 161 |
| 59S/T15-10P  | 7314150532759 | 1  | 161 |
| 59S/T15-30P  | 7314150200887 | 1  | 161 |
| 59S/T15-3P   | 7314150201464 | 1  | 161 |
| 59S/T15CS    | 7314150444021 | 1  | 161 |
| 59S/T15PEN   | 7314150458929 | 1  | 168 |
| 59S/T20-30P  | 7314150200894 | 1  | 161 |
| 59S/T20-3P   | 7314150201471 | 1  | 161 |
| 59S/T20CS    | 7314150444038 | 1  | 161 |
| 59S/T20PEN   | 7314150458936 | 1  | 168 |
| 59S/T25      | 7314150198566 | 1  | 161 |
| 59S/T25-30P  | 7314150200900 | 1  | 161 |
| 59S/T25-3P   | 7314150201488 | 1  | 161 |
| 59S/T25CS    | 7314150444045 | 1  | 161 |
| 59S/T25PEN   | 7314150458943 | 1  | 168 |
| 59S/T27      | 7314150198580 | 1  | 161 |
| 59S/T27-3P   | 7314150201495 | 1  | 161 |
| 59S/T27CS    | 7314150444052 | 1  | 161 |
| 59S/T3       | 7314150198443 | 1  | 161 |
| 59S/T3-3P    | 7314150258840 | 1  | 161 |
| 59S/T30-10P  | 7314150251988 | 1  | 161 |
| 59S/T30-30P  | 7314150200924 | 1  | 161 |
| 59S/T30-3P   | 7314150201501 | 1  | 161 |
| 59S/T30CS    | 7314150444069 | 1  | 161 |
| 59S/T4       | 7314150198450 | 1  | 161 |
| 59S/T4-3P    | 7314150258857 | 1  | 161 |
| 59S/T40      | 7314150198610 | 1  | 161 |
| 59S/T40-30P  | 7314150200931 | 1  | 161 |
| 59S/T40-3P   | 7314150201518 | 1  | 161 |
| 59S/T40CS    | 7314150444076 | 1  | 161 |
| 59S/T45-3P   | 7314150258918 | 1  | 161 |
| 59S/T45-5P   | 7314150532971 | 1  | 161 |
| 59S/T5       | 7314150198467 | 1  | 161 |
| 59S/T5-3P    | 7314150258864 | 1  | 161 |
| 59S/T50      | 7314150198658 | 1  | 161 |
| 59S/T50-3P   | 7314150258925 | 1  | 161 |
| 59S/T6       | 7314150198474 | 1  | 161 |
| 59S/T6-3P    | 7314150258871 | 1  | 161 |
| 59S/T7       | 7314150198498 | 1  | 161 |
| 59S/T7-3P    | 7314150258888 | 1  | 161 |
| 59S/T8       | 7314150198504 | 1  | 161 |
| 59S/T8-3P    | 7314150258895 | 1  | 161 |
| 59S/T9       | 7314150198511 | 1  | 161 |
| 59S/T9-3P    | 7314150258901 | 1  | 161 |
| 59S/TCS11-1  | 7314150444083 | 1  | 165 |
| 59S/TR10     | 7314150198702 | 1  | 161 |
| 59S/TR10-3P  | 7314150201525 | 1  | 161 |
| 59S/TR15     | 7314150198719 | 1  | 161 |
| 59S/TR15-3P  | 7314150201532 | 1  | 161 |
| 59S/TR20     | 7314150198726 | 1  | 161 |
| 59S/TR20-3P  | 7314150201549 | 1  | 161 |
| 59S/TR25     | 7314150198740 | 1  | 161 |
| 59S/TR25-3P  | 7314150201556 | 1  | 161 |
| 59S/TR27     | 7314150198757 | 1  | 161 |
| 59S/TR27-3P  | 7314150201570 | 1  | 161 |
| 59S/TR30     | 7314150198771 | 1  | 161 |
| 59S/TR30-3P  | 7314150201587 | 1  | 161 |
| 59S/TR40     | 7314150198795 | 1  | 161 |
| 59S/TR40-3P  | 7314150201594 | 1  | 161 |
| 59S/TR7      | 7314150198672 | 1  | 161 |
| 59S/TR7-3P   | 7314150258932 | 1  | 161 |
| 59S/TR8      | 7314150198689 | 1  | 161 |
| 59S/TR8-3P   | 7314150258949 | 1  | 161 |
| 59S/TR9      | 7314150198696 | 1  | 161 |
| 59S/TR9-3P   | 7314150258956 | 1  | 161 |
| 59S/TS-0     | 7314150199389 | 1  | 162 |
| 59S/TS-1     | 7314150199396 | 1  | 162 |
| 59S/TS-1/4   | 7314150199594 | 1  | 162 |
| 59S/TS-10-5P | 7314150533138 | 1  | 162 |
| 59S/TS-2     | 7314150199419 | 1  | 162 |
| 59S/TS-3     | 7314150199433 | 1  | 162 |
| 59S/TS-4-5P  | 7314150533152 | 1  | 162 |
| 59S/TS-5-5P  | 7314150533176 | 1  | 162 |
| 59S/TS-6-5P  | 7314150533190 | 1  | 162 |
| 59S/TS-8-5P  | 7314150533220 | 1  | 162 |
| 59S/TW0      | 7314150199617 | 1  | 162 |
| 59S/TW1      | 7314150199631 | 1  | 162 |
| 59S/TW2      | 7314150199655 | 1  | 162 |
| 59S/TW3      | 7314150199679 | 1  | 162 |
| 59S/TW4      | 7314150199693 | 1  | 162 |
| 59S/TW5      | 7314150199716 | 1  | 162 |
| 6            | 8412814220048 | 1  | 218 |
| 6-342-06-2-0 | 7311518021719 | 10 | 30  |
| 6-342-06-2-2 | 7311518244170 | 5  | 30  |
| 6-342-08-1-0 | 7311518021726 | 10 | 30  |
| 6-342-08-1-2 | 7311518028282 | 5  | 30  |
| 6-342-08-2-0 | 7311518021733 | 10 | 30  |
| 6-342-08-2-2 | 7311518005375 | 5  | 30  |
| 6-342-10-1-0 | 7311518021757 | 10 | 30  |
| 6-342-10-1-2 | 7311518005382 | 5  | 30  |
| 6-342-10-2-0 | 7311518021764 | 10 | 30  |
| 6-342-10-2-2 | 7311518005399 | 5  | 30  |
| 6-343-08-2-0 | 7311518021801 | 10 | 30  |
| 6-343-08-2-2 | 7311518001070 | 5  | 30  |

|              |               |    |     |
|--------------|---------------|----|-----|
| 6-343-08-3-0 | 7311518021818 | 10 | 30  |
| 6-343-10-2-0 | 7311518021825 | 10 | 30  |
| 6-343-10-2-2 | 7311518001094 | 5  | 30  |
| 6-343-10-3-0 | 7311518021832 | 10 | 30  |
| 6-344-08-2-0 | 7311518021887 | 10 | 30  |
| 6-344-08-2-2 | 7311518005344 | 5  | 30  |
| 6-344-10-2-0 | 7311518021900 | 10 | 30  |
| 6-344-10-2-2 | 7311518005351 | 5  | 30  |
| 6-345-08-1-2 | 7311518028312 | 5  | 31  |
| 6-345-08-2-0 | 7311518021948 | 10 | 31  |
| 6-345-08-2-2 | 7311518005412 | 5  | 31  |
| 6-345-10-1-2 | 7311518005429 | 5  | 31  |
| 6-345-10-2-0 | 7311518021955 | 10 | 31  |
| 6-470-08-2-2 | 7311518242008 | 5  | 31  |
| 600-3        | 7314150124787 | 1  | 208 |
| 600.003.010  | 8412814600000 | 1  | 372 |
| 600.005.012  | 8412814600017 | 1  | 372 |
| 601000800    | 8413345202299 | 1  | 589 |
| 601001000    | 8413345202305 | 1  | 589 |
| 601001250    | 8413345202312 | 1  | 589 |
| 601001500    | 8413345202329 | 1  | 589 |
| 6010H0800    | 8413345015769 | 1  | 590 |
| 6010H1000    | 8413345015776 | 1  | 590 |
| 6010H1250    | 8413345015783 | 1  | 590 |
| 6010H1500    | 8413345015790 | 1  | 590 |
| 6010M0800    | 8413345015806 | 1  | 589 |
| 6010M1000    | 8413345015813 | 1  | 589 |
| 6010M1250    | 8413345015820 | 1  | 589 |
| 6010M1500    | 8413345015837 | 1  | 589 |
| 601A         | 7314150476282 | 5  | 654 |
| 602-4-LA     | 7314150224357 | 1  | 208 |
| 604-5        | 7314150124800 | 1  | 208 |
| 6040M0630    | 8413345124126 | 1  | 590 |
| 605-10-PC-AU | 7314150186334 | 1  | 209 |
| 605-6        | 7314150153770 | 1  | 209 |
| 606-6        | 7314150124824 | 1  | 209 |
| 6070H1000    | 8413345030656 | 1  | 589 |
| 6070H1250    | 8413345084833 | 1  | 589 |
| 6070H1500    | 8413345030663 | 1  | 589 |
| 6070H1750    | 8413345030670 | 1  | 589 |
| 607201000    | 8413345030533 | 1  | 589 |
| 607201250    | 8413345030540 | 1  | 589 |
| 607201500    | 8413345030557 | 1  | 589 |
| 607201750    | 8413345030564 | 1  | 589 |
| 6072M1000    | 8413345015813 | 1  | 589 |
| 6072M1500    | 8413345137454 | 1  | 589 |
| 6072M1750    | 8413345030687 | 1  | 589 |
| 60T/17-1     | 7314150191529 | 1  | 158 |
| 60T/31-1     | 7314150191482 | 1  | 158 |
| 60T/7-1      | 7314150191574 | 1  | 158 |
| 60T/PH1      | 7314150199488 | 1  | 158 |
| 60T/PH2      | 7314150199495 | 1  | 158 |
| 60T/PH3      | 7314150199501 | 1  | 158 |
| 60T/PZ1      | 7314150199525 | 1  | 158 |
| 60T/PZ2      | 7314150199549 | 1  | 158 |
| 60T/PZ3      | 7314150199563 | 1  | 158 |
| 60T/T15      | 7314150199662 | 1  | 158 |
| 60T/T20      | 7314150199686 | 1  | 158 |
| 60T/T25      | 7314150199709 | 1  | 158 |
| 60T/T27      | 7314150199723 | 1  | 158 |
| 60T/T40      | 7314150199761 | 1  | 158 |
| 60T/T7       | 7314150199587 | 1  | 158 |
| 60T/T9       | 7314150199624 | 1  | 158 |
| 610-6        | 7314150124848 | 1  | 209 |
| 611-10-200   | 7314150124428 | 10 | 210 |
| 611-3.5-100  | 7314150124336 | 10 | 210 |
| 611-3.5-75   | 7314150124329 | 10 | 210 |
| 611-4-100    | 7314150124350 | 10 | 210 |
| 611-4-75     | 7314150124343 | 10 | 210 |
| 611-5.5-100  | 7314150124367 | 10 | 210 |
| 611-5.5-125  | 7314150124381 | 10 | 210 |
| 611-6.5-125  | 7314150124374 | 10 | 210 |
| 611-6.5-150  | 7314150124398 | 10 | 210 |
| 611-6.5-25   | 7314150124602 | 10 | 210 |
| 611-8-150    | 7314150124404 | 10 | 210 |
| 611-8-175    | 7314150124411 | 10 | 210 |
| 612-5        | 7314150124817 | 1  | 208 |
| 613-3-100    | 7314150124442 | 10 | 210 |
| 613-3-75     | 7314150124435 | 10 | 210 |
| 613-3.5-100  | 7314150124459 | 10 | 210 |
| 613-4-100    | 7314150124466 | 10 | 210 |
| 613-4-125    | 7314150124473 | 10 | 210 |
| 613-5.5-150  | 7314150124497 | 10 | 210 |
| 613-6.5-150  | 7314150124503 | 10 | 210 |
| 614A         | 7314150476305 | 5  | 654 |
| 615-0-75     | 7314150124558 | 10 | 210 |
| 615-1-100    | 7314150124565 | 10 | 210 |
| 615-2-125    | 7314150124572 | 10 | 210 |
| 615-2-25     | 7314150124596 | 10 | 210 |
| 615-3-150    | 7314150124589 | 10 | 210 |
| 6151         | 7314150539185 | 10 | 652 |
| 6152         | 7314150539192 | 10 | 652 |
| 6152SS       | 7314150539215 | 10 | 652 |
| 6159         | 7314150539208 | 10 | 653 |
| 616-0-75     | 7314150124510 | 10 | 210 |
| 616-1-100    | 7314150124527 | 10 | 210 |





|             |               |    |     |
|-------------|---------------|----|-----|
| 616-2-125   | 7314150124534 | 10 | 210 |
| 616-3-150   | 7314150124541 | 10 | 210 |
| 618-10-75   | 7314150124619 | 10 | 210 |
| 618-15-100  | 7314150124626 | 10 | 210 |
| 618-20-100  | 7314150124633 | 10 | 210 |
| 618-25-125  | 7314150124640 | 10 | 210 |
| 618-27-125  | 7314150124657 | 10 | 210 |
| 618-30-150  | 7314150124664 | 10 | 210 |
| 618-40-150  | 7314150124671 | 10 | 210 |
| 61H/50PH1   | 7314150200382 | 1  | 159 |
| 61H/50PZ1   | 7314150200412 | 1  | 159 |
| 61H/50PZ2   | 7314150200429 | 1  | 159 |
| 61H/50PZ3   | 7314150200436 | 1  | 159 |
| 61H/50T10   | 7314150200443 | 1  | 159 |
| 61H/50T15   | 7314150200450 | 1  | 159 |
| 61H/50T25   | 7314150200474 | 1  | 159 |
| 61H/50T30   | 7314150200481 | 1  | 159 |
| 61H/PH1     | 7314150199006 | 1  | 158 |
| 61H/PH2     | 7314150199020 | 1  | 158 |
| 61H/PH3     | 7314150199044 | 1  | 158 |
| 61H/PZ3     | 7314150199105 | 1  | 159 |
| 61H/T10     | 7314150199129 | 1  | 159 |
| 61H/T15     | 7314150199143 | 1  | 159 |
| 61H/T20     | 7314150199167 | 1  | 159 |
| 61H/T25     | 7314150199181 | 1  | 159 |
| 61H/T40     | 7314150199235 | 1  | 159 |
| 620-6       | 7314150128594 | 1  | 497 |
| 622-3P      | 7314150427727 | 1  | 248 |
| 6221D       | 7314150421596 | 10 | 248 |
| 6221D IP    | 7314150440368 | 10 | 248 |
| 6222D       | 7314150421589 | 10 | 248 |
| 6222D IP    | 7314150437702 | 10 | 248 |
| 6223D       | 7314150421558 | 8  | 248 |
| 6223D IP    | 7314150421794 | 8  | 248 |
| 6224        | 7314150421619 | 4  | 247 |
| 6224D       | 7314150421565 | 5  | 248 |
| 6224D IP    | 7314150421800 | 5  | 248 |
| 6225D       | 7314150421572 | 10 | 248 |
| 6225D IP    | 7314150421817 | 5  | 248 |
| 623-3-100   | 7314150128518 | 10 | 497 |
| 623-3.5-100 | 7314150128525 | 10 | 497 |
| 623-4-100   | 7314150128532 | 10 | 497 |
| 623-5.5-125 | 7314150128549 | 10 | 497 |
| 623-6.5-150 | 7314150128556 | 10 | 497 |
| 625         | 7311518221614 | 5  | 548 |
| 625-0-100   | 7314150128563 | 10 | 497 |
| 625-1-150   | 7314150128570 | 10 | 497 |
| 625-2-175   | 7314150128587 | 10 | 497 |
| 625-DROP    | 7311518221638 | 10 | 548 |
| 625-PEAR    | 7311518221621 | 10 | 548 |
| 625-ROUND   | 7311518221645 | 10 | 548 |
| 6258        | 7314150539222 | 10 | 653 |
| 62TIN/50PH1 | 7314150200504 | 1  | 157 |
| 62TIN/50PH3 | 7314150200528 | 1  | 157 |
| 62TIN/50PZ1 | 7314150200535 | 1  | 157 |
| 62TIN/50PZ2 | 7314150200542 | 1  | 157 |
| 62TIN/50PZ3 | 7314150200559 | 1  | 157 |
| 62TIN/7-1   | 7314150203505 | 1  | 157 |
| 62TIN/PH1   | 7314150199259 | 1  | 157 |
| 62TIN/PZ1   | 7314150199327 | 1  | 157 |
| 62TIN/PZ2   | 7314150199334 | 1  | 157 |
| 62TIN/PZ3   | 7314150199358 | 1  | 157 |
| 62TIN/T15   | 7314150199402 | 1  | 157 |
| 62TIN/T20   | 7314150199426 | 1  | 157 |
| 62TIN/T25   | 7314150199440 | 1  | 157 |
| 62TIN/T30   | 7314150199464 | 1  | 157 |
| 63D/50PZ1   | 7314150200320 | 1  | 157 |
| 63D/50PZ2   | 7314150200337 | 1  | 157 |
| 63D/50PZ3   | 7314150200344 | 1  | 157 |
| 63D/7-1     | 7314150191604 | 1  | 157 |
| 63D/PH2G    | 7314150198979 | 1  | 156 |
| 63D/PH3     | 7314150198948 | 1  | 156 |
| 63D/PZ1     | 7314150198856 | 1  | 156 |
| 63D/PZ2     | 7314150198870 | 1  | 156 |
| 63D/T10     | 7314150198665 | 1  | 156 |
| 63D/T15     | 7314150198733 | 1  | 156 |
| 63D/T40     | 7314150198832 | 1  | 156 |
| 64A/PH1     | 7314150198481 | 1  | 157 |
| 64A/PH3     | 7314150198573 | 1  | 157 |
| 64A/PZ1     | 7314150198603 | 1  | 158 |
| 64A/PZ3     | 7314150198634 | 1  | 158 |
| 650         | 7311518221591 | 5  | 548 |
| 65I/7-1     | 7314150204113 | 1  | 529 |
| 65I/PH1     | 7314150199785 | 1  | 529 |
| 65I/PH1-2P  | 7314150207985 | 1  | 529 |
| 65I/PH2     | 7314150199884 | 1  | 529 |
| 65I/PH2-2P  | 7314150201259 | 1  | 529 |
| 65I/PH3     | 7314150199907 | 1  | 529 |
| 65I/PH3-2P  | 7314150201266 | 1  | 529 |
| 65I/PZ1     | 7314150199921 | 1  | 529 |
| 65I/PZ1-2P  | 7314150201273 | 1  | 529 |
| 65I/PZ2     | 7314150199945 | 1  | 529 |
| 65I/PZ2-2P  | 7314150201280 | 1  | 529 |
| 65I/PZ3     | 7314150199969 | 1  | 529 |
| 65I/PZ3-2P  | 7314150201297 | 1  | 529 |
| 65I/T15     | 7314150199990 | 1  | 529 |



|                |               |   |     |
|----------------|---------------|---|-----|
| 65I/T25        | 7314150200030 | 1 | 529 |
| 65I/T30        | 7314150200054 | 1 | 529 |
| 65I/T40        | 7314150200078 | 1 | 529 |
| 65I/T40-2P     | 7314150201358 | 1 | 529 |
| 665            | 7311518221607 | 5 | 548 |
| 66IM/10C-1     | 7314150450732 | 1 | 160 |
| 66IM/11C-1     | 7314150450718 | 1 | 160 |
| 66IM/50PH1-2P  | 7314150446056 | 1 | 159 |
| 66IM/50PH2-2P  | 7314150446063 | 1 | 159 |
| 66IM/50PH3-2P  | 7314150446087 | 1 | 159 |
| 66IM/50PZ1-2P  | 7314150446094 | 1 | 160 |
| 66IM/50PZ2-2P  | 7314150446100 | 1 | 160 |
| 66IM/50PZ3-2P  | 7314150446117 | 1 | 160 |
| 66IM/50T10C-2P | 7314150446131 | 1 | 160 |
| 66IM/50T15C-2P | 7314150446148 | 1 | 160 |
| 66IM/50T20C-2P | 7314150446155 | 1 | 160 |
| 66IM/50T25C-2P | 7314150446162 | 1 | 160 |
| 66IM/50T27C-2P | 7314150446179 | 1 | 160 |
| 66IM/50T30C-2P | 7314150446186 | 1 | 160 |
| 66IM/50T40C-2P | 7314150446193 | 1 | 160 |
| 66IM/PH1-2P    | 7314150445929 | 1 | 159 |
| 66IM/PH2-2P    | 7314150445936 | 1 | 159 |
| 66IM/PH3-2P    | 7314150445943 | 1 | 159 |
| 66IM/PZ1-2P    | 7314150445950 | 1 | 159 |
| 66IM/PZ2-2P    | 7314150445967 | 1 | 159 |
| 66IM/PZ3-2P    | 7314150445974 | 1 | 159 |
| 66IM/T10C-2P   | 7314150445981 | 1 | 159 |
| 66IM/T15C-2P   | 7314150445998 | 1 | 159 |
| 66IM/T20C-2P   | 7314150446001 | 1 | 159 |
| 66IM/T25C-2P   | 7314150446018 | 1 | 159 |
| 66IM/T27C-2P   | 7314150446025 | 1 | 159 |
| 66IM/T30C-2P   | 7314150446032 | 1 | 159 |
| 66IM/T40C-2P   | 7314150446049 | 1 | 159 |
| 6700SM-10      | 7314151088026 | 5 | 78  |
| 6700SM-11      | 7314151088033 | 5 | 78  |
| 6700SM-12      | 7314151088040 | 5 | 78  |
| 6700SM-13      | 7314151088057 | 5 | 78  |
| 6700SM-14      | 7314151088064 | 5 | 78  |
| 6700SM-4       | 7314151087944 | 5 | 78  |
| 6700SM-4.5     | 7314151087951 | 5 | 78  |
| 6700SM-5       | 7314151087968 | 5 | 78  |
| 6700SM-5.5     | 7314151087975 | 5 | 78  |
| 6700SM-6       | 7314151087982 | 5 | 78  |
| 6700SM-7       | 7314151087999 | 5 | 78  |
| 6700SM-8       | 7314151088002 | 5 | 78  |
| 6700SM-9       | 7314151088019 | 5 | 78  |
| 6700SZ-1/2     | 7314151088194 | 5 | 78  |
| 6700SZ-1/4     | 7314151088132 | 5 | 78  |
| 6700SZ-1/8     | 7314150346349 | 5 | 78  |
| 6700SZ-11/32   | 7314151088163 | 5 | 78  |
| 6700SZ-3/16    | 7314151088118 | 5 | 78  |
| 6700SZ-3/8     | 7314151088170 | 5 | 78  |
| 6700SZ-5/16    | 7314151088156 | 5 | 78  |
| 6700SZ-5/32    | 7314151808556 | 5 | 78  |
| 6700SZ-7/16    | 7314151088187 | 5 | 78  |
| 6700SZ-7/32    | 7314151088125 | 5 | 78  |
| 6700SZ-9/16    | 7314151088200 | 5 | 78  |
| 6700SZ-9/32    | 7314151088149 | 5 | 78  |
| 6700TORX-E10   | 7314153011725 | 5 | 78  |
| 6700TORX-E4    | 7314153011671 | 5 | 78  |
| 6700TORX-E5    | 7314153011688 | 5 | 78  |
| 6700TORX-E6    | 7314153011695 | 5 | 78  |
| 6700TORX-E7    | 7314153011701 | 5 | 78  |
| 6700TORX-E8    | 7314153011718 | 5 | 78  |
| 6706TE         | 7314150220199 | 1 | 69  |
| 6708DMB        | 7314150220205 | 1 | 69  |
| 6709-IP10      | 7314150354498 | 1 | 83  |
| 6709-IP15      | 7314150354504 | 1 | 83  |
| 6709-IP20      | 7314150354511 | 1 | 83  |
| 6709-IP25      | 7314150354528 | 1 | 83  |
| 6709-IP27      | 7314150354535 | 1 | 83  |
| 6709-IP30      | 7314150354542 | 1 | 83  |
| 6709-IP40      | 7314150354559 | 1 | 83  |
| 6709-IP45      | 7314150354566 | 1 | 83  |
| 6709-IP6       | 7314150460373 | 1 | 83  |
| 6709-IP7       | 7314150460366 | 1 | 83  |
| 6709-IP8       | 7314150460359 | 1 | 83  |
| 6709-IP9       | 7314150460342 | 1 | 83  |
| 6709F-4.5      | 7314151830762 | 5 | 82  |
| 6709F-5.5      | 7314151830779 | 5 | 82  |
| 6709F-6.5      | 7314150220397 | 5 | 82  |
| 6709F-8        | 7314151830786 | 5 | 82  |
| 6709HL         | 7314150128457 | 1 | 81  |
| 6709M-10       | 7314150430833 | 5 | 83  |
| 6709M-3        | 7314151830656 | 5 | 83  |
| 6709M-4        | 7314151830663 | 5 | 83  |
| 6709M-5        | 7314151830670 | 5 | 83  |
| 6709M-6        | 7314151830687 | 5 | 83  |
| 6709M-8        | 7314151830694 | 5 | 83  |
| 6709PH-1       | 7314151830700 | 5 | 82  |
| 6709PH-2       | 7314151830717 | 5 | 82  |
| 6709PH-3       | 7314151830724 | 5 | 82  |
| 6709PZ-1       | 7314151830731 | 5 | 82  |
| 6709PZ-2       | 7314151830748 | 5 | 82  |
| 6709PZ-3       | 7314151830755 | 5 | 82  |
| 6709TORX-R-T10 | 7314153002471 | 1 | 83  |





|                |               |    |     |
|----------------|---------------|----|-----|
| 6709TORX-R-T15 | 7314153002488 | 1  | 83  |
| 6709TORX-R-T20 | 7314153002495 | 1  | 83  |
| 6709TORX-R-T25 | 7314153002501 | 1  | 83  |
| 6709TORX-R-T8  | 7314153002464 | 1  | 83  |
| 6709TORX-T10   | 7314151811679 | 5  | 83  |
| 6709TORX-T15   | 7314151811686 | 5  | 83  |
| 6709TORX-T20   | 7314151811693 | 5  | 83  |
| 6709TORX-T25   | 7314151811709 | 5  | 83  |
| 6709TORX-T27   | 7314151811716 | 5  | 83  |
| 6709TORX-T30   | 7314151811723 | 5  | 83  |
| 6709TORX-T40   | 7314153002457 | 5  | 83  |
| 6709TORX-T6    | 7314150460540 | 5  | 83  |
| 6709TORX-T7    | 7314150460557 | 5  | 83  |
| 6709TORX-T8    | 7314153002440 | 5  | 83  |
| 6709TORX-T9    | 7314151811662 | 5  | 83  |
| 671002600      | 8413345128971 | 50 | 553 |
| 671002850      | 8413345128988 | 1  | 553 |
| 6711MB         | 7314150220298 | 1  | 69  |
| 6712R          | 7314151838225 | 1  | 65  |
| 6712RN         | 7314151838232 | 1  | 65  |
| 6713MH         | 7314150220212 | 1  | 68  |
| 6715GE         | 7314151831370 | 1  | 67  |
| 6715GJ         | 7314151831363 | 1  | 67  |
| 6715MG         | 7314151831349 | 1  | 66  |
| 6715MGS        | 7314151831332 | 1  | 65  |
| 6715MZ         | 7314153003218 | 1  | 68  |
| 6715PZ         | 7314151837525 | 1  | 67  |
| 6717MBP        | 7314150218806 | 1  | 66  |
| 6719MHR        | 7314150218783 | 1  | 65  |
| 6719SM         | 7314151820817 | 1  | 66  |
| 6720NM         | 7314151088262 | 1  | 67  |
| 6721NM         | 7314151088309 | 1  | 66  |
| 6722M          | 7314151594411 | 1  | 67  |
| 6729MHP        | 7314150218752 | 1  | 66  |
| 6729MHR        | 7314150218769 | 1  | 65  |
| 6729SM         | 7314153003225 | 1  | 68  |
| 6729SZ         | 7314153003232 | 1  | 68  |
| 6730MBP        | 7314150218776 | 1  | 66  |
| 677-10         | 7314150362486 | 1  | 51  |
| 677-13         | 7314150362493 | 1  | 51  |
| 677-3/8        | 7314150362509 | 1  | 51  |
| 677-7          | 7314150362455 | 1  | 51  |
| 677-8          | 7314150362462 | 1  | 51  |
| 677-9          | 7314150362479 | 1  | 51  |
| 679-1/2        | 7314150363384 | 1  | 54  |
| 679-10         | 7314150357345 | 1  | 54  |
| 679-11         | 7314150357352 | 1  | 54  |
| 679-12         | 7314150357369 | 1  | 54  |
| 679-13         | 7314150357376 | 1  | 54  |
| 679-14         | 7314150357383 | 1  | 54  |
| 679-3/8        | 7314150363360 | 1  | 54  |
| 679-7          | 7314150357536 | 1  | 54  |
| 679-7/16       | 7314150363377 | 1  | 54  |
| 679-8          | 7314150357079 | 1  | 54  |
| 679-9          | 7314150357338 | 1  | 54  |
| 679-9/16       | 7314150363391 | 1  | 54  |
| 6821NZ         | 7314151089269 | 1  | 68  |
| 6852-5         | 7314150125463 | 1  | 111 |
| 6852-5/S17     | 7314150135875 | 1  | 112 |
| 6852P-5        | 7314150416585 | 1  | 112 |
| 6876N          | 7314151845575 | 1  | 112 |
| 6878N          | 7314151845582 | 1  | 112 |
| 6880N          | 7314151845599 | 1  | 112 |
| 690000160      | 8413345008068 | 1  | 610 |
| 690000200      | 8413345008082 | 1  | 610 |
| 690000220      | 8413345008099 | 1  | 610 |
| 690000250      | 8413345008105 | 1  | 610 |
| 690000300      | 8413345008129 | 1  | 610 |
| 690000320      | 8413345087476 | 1  | 610 |
| 690000350      | 8413345008136 | 1  | 610 |
| 690000400      | 8413345008143 | 1  | 610 |
| 690000500      | 8413345008167 | 1  | 610 |
| 690000630      | 8413345111065 | 1  | 610 |
| 69079019P      | 8413345111089 | 1  | 610 |
| 690900080      | 8413345016209 | 4  | 610 |
| 690900100      | 8413345016216 | 4  | 610 |
| 690900120      | 8413345016223 | 2  | 610 |
| 690900140      | 8413345016230 | 2  | 610 |
| 690900200      | 8413345016247 | 1  | 610 |
| 6950           | 7314151089641 | 1  | 84  |
| 6950-SPARE     | 7314150187867 | 1  | 85  |
| 6950RN         | 7314151831189 | 1  | 84  |
| 6950RN-SPARE   | 7314150209149 | 1  | 85  |
| 6950SL         | 7314150197668 | 1  | 84  |
| 6950SL-SPARE   | 7314150210251 | 1  | 85  |
| 6951           | 7314151089764 | 1  | 84  |
| 6954           | 7314151089795 | 1  | 80  |
| 6956           | 7314151089825 | 10 | 80  |
| 6958-6         | 7314150476329 | 1  | 80  |
| 6960           | 7314151089856 | 1  | 81  |
| 6960-3         | 7314150489381 | 10 | 81  |
| 6960F-6        | 7314150489206 | 20 | 81  |
| 6960W-2        | 7314150470860 | 10 | 81  |
| 6960W-4        | 7314150470877 | 1  | 81  |
| 6960W-6        | 7314150470884 | 10 | 81  |
| 6961           | 7314151089870 | 1  | 81  |



|                 |               |    |     |
|-----------------|---------------|----|-----|
| 6962            | 7314151089894 | 1  | 81  |
| 6962L           | 7314151089917 | 1  | 81  |
| 6966            | 7314151089986 | 10 | 81  |
| 6968            | 7314150128426 | 1  | 81  |
| 6969            | 7314150489268 | 1  | 82  |
| 696EX-01        | 7314150386192 | 1  | 81  |
| 696EX-06        | 7314150386239 | 1  | 81  |
| 696EX-08        | 7314150386246 | 1  | 81  |
| 696EX-11        | 7314150386208 | 1  | 81  |
| 6972H           | 7314151215934 | 5  | 81  |
| 6973A           | 7314150339495 | 10 | 82  |
| 6973M           | 7314150339501 | 1  | 81  |
| 6973N           | 7314151845605 | 1  | 111 |
| 6976N           | 7314151845612 | 1  | 111 |
| 6978N           | 7314151845629 | 1  | 111 |
| 6M-10-11        | 7314151832094 | 10 | 48  |
| 6M-10-13        | 7314151832117 | 10 | 48  |
| 6M-12-13        | 7314151832131 | 10 | 48  |
| 6M-12-14        | 7314151832148 | 10 | 48  |
| 6M-13-14        | 7314151832155 | 10 | 48  |
| 6M-13-15        | 7314151832162 | 10 | 48  |
| 6M-13-16        | 7314151832179 | 10 | 48  |
| 6M-13-17        | 7314151832186 | 10 | 48  |
| 6M-14-15        | 7314151832193 | 10 | 48  |
| 6M-14-17        | 7314151832209 | 10 | 48  |
| 6M-16-17        | 7314151832216 | 10 | 48  |
| 6M-16-18        | 7314151832223 | 10 | 48  |
| 6M-17-19        | 7314151832230 | 10 | 48  |
| 6M-18-19        | 7314151832247 | 10 | 48  |
| 6M-19-22        | 7314151832261 | 10 | 48  |
| 6M-19-24        | 7314151832278 | 10 | 48  |
| 6M-20-22        | 7314151832285 | 10 | 48  |
| 6M-21-23        | 7314151832292 | 10 | 48  |
| 6M-21-24        | 7314151838072 | 10 | 48  |
| 6M-22-24        | 7314151832308 | 10 | 48  |
| 6M-24-26        | 7314151832315 | 10 | 48  |
| 6M-24-27        | 7314151832322 | 10 | 48  |
| 6M-24-30        | 7314151832339 | 5  | 48  |
| 6M-25-28        | 7314151832353 | 5  | 48  |
| 6M-27-29        | 7314150189861 | 5  | 48  |
| 6M-27-30        | 7314151832360 | 5  | 48  |
| 6M-27-32        | 7314151832377 | 5  | 48  |
| 6M-30-32        | 7314151832384 | 5  | 48  |
| 6M-30-36        | 7314151832407 | 5  | 48  |
| 6M-32-36        | 7314151832414 | 5  | 48  |
| 6M-34-36        | 7314151832421 | 1  | 48  |
| 6M-36-41        | 7314151832438 | 1  | 48  |
| 6M-38-42        | 7314151832445 | 1  | 48  |
| 6M-4-5          | 7314151832018 | 10 | 48  |
| 6M-4-5-5.5      | 7314151832025 | 10 | 48  |
| 6M-41-46        | 7314151832452 | 1  | 48  |
| 6M-46-50        | 7314151832469 | 1  | 48  |
| 6M-5-5.5        | 7314151832032 | 10 | 48  |
| 6M-5-5-7        | 7314151832049 | 10 | 48  |
| 6M-6-7          | 7314151832056 | 10 | 48  |
| 6M-7-8          | 7314151832063 | 10 | 48  |
| 6M-8-10         | 7314151832087 | 10 | 48  |
| 6M-8-9          | 7314151832070 | 10 | 48  |
| 6M/10C          | 7314150212934 | 1  | 50  |
| 6M/12C          | 7314150212941 | 1  | 50  |
| 6M/6C           | 7314150212910 | 1  | 50  |
| 6M/8C           | 7314150212927 | 1  | 50  |
| 6M/S8           | 7314151832483 | 1  | 49  |
| 6M/SH12         | 7314153013439 | 1  | 49  |
| 6M/SH8          | 7314150201365 | 1  | 49  |
| 6MV-10          | 7314150120871 | 5  | 501 |
| 6MV-11          | 7314150120888 | 5  | 501 |
| 6MV-12          | 7314150120895 | 5  | 501 |
| 6MV-13          | 7314150120901 | 5  | 501 |
| 6MV-14          | 7314150120918 | 5  | 501 |
| 6MV-15          | 7314150120925 | 5  | 501 |
| 6MV-16          | 7314150120932 | 5  | 501 |
| 6MV-17          | 7314150120949 | 3  | 501 |
| 6MV-18          | 7314150120956 | 3  | 501 |
| 6MV-19          | 7314150120963 | 3  | 501 |
| 6MV-20          | 7314150120970 | 3  | 501 |
| 6MV-21          | 7314150120987 | 3  | 501 |
| 6MV-22          | 7314150120994 | 3  | 501 |
| 6MV-23          | 7314150121001 | 3  | 501 |
| 6MV-24          | 7314150121014 | 3  | 501 |
| 6MV-27          | 7314150121021 | 2  | 501 |
| 6MV-30          | 7314150121038 | 2  | 501 |
| 6MV-32          | 7314150121052 | 2  | 501 |
| 6MV-6           | 7314150120833 | 5  | 501 |
| 6MV-7           | 7314150120840 | 5  | 501 |
| 6MV-8           | 7314150120857 | 5  | 501 |
| 6MV-9           | 7314150120864 | 5  | 501 |
| 6MV/10T         | 7314150213023 | 1  | 504 |
| 6MV/8T          | 7314150122141 | 1  | 504 |
| 6Z-1-1.1/8      | 7314151832674 | 1  | 49  |
| 6Z-1.1/16-1.1/4 | 7314151832681 | 1  | 49  |
| 6Z-1.1/4-1.3/8  | 7314151832698 | 1  | 49  |
| 6Z-1/2-9/16     | 7314151832568 | 5  | 49  |
| 6Z-1/4-5/16     | 7314151832520 | 5  | 49  |
| 6Z-11/16-3/4    | 7314151832612 | 5  | 49  |
| 6Z-13/16-7/8    | 7314151832643 | 5  | 49  |





|                 |               |   |     |
|-----------------|---------------|---|-----|
| 6Z-15/16-1      | 7314151832667 | 5 | 49  |
| 6Z-19/32-11/16  | 7314151832582 | 5 | 49  |
| 6Z-25/32-13/16  | 7314151832636 | 5 | 49  |
| 6Z-3/4-7/8      | 7314151832629 | 5 | 49  |
| 6Z-3/8-7/16     | 7314151832544 | 5 | 49  |
| 6Z-5/16-11/32   | 7314151832537 | 5 | 49  |
| 6Z-5/8-3/4      | 7314151832605 | 5 | 49  |
| 6Z-7/16-1/2     | 7314151832551 | 5 | 49  |
| 6Z-7/8-15/16    | 7314151832650 | 5 | 49  |
| 6Z-9/16-5/8     | 7314151832575 | 5 | 49  |
| 6Z/8C           | 7314150212958 | 1 | 50  |
| 700-1-50        | 7314153017673 | 5 | 213 |
| 700-1.2-50      | 7314153017680 | 5 | 213 |
| 700-1.5-50      | 7314153017697 | 5 | 213 |
| 700-1.8-50      | 7314153017703 | 5 | 213 |
| 700-2-50        | 7314153017710 | 5 | 213 |
| 700-2.5-50      | 7314153017741 | 5 | 213 |
| 700-3-100       | 7314153017772 | 5 | 213 |
| 700-3-200       | 7314153017789 | 5 | 213 |
| 700-3-50        | 7314153017765 | 5 | 213 |
| 700-3.5-75      | 7314153017796 | 5 | 213 |
| 700-4-250       | 7314153017819 | 5 | 213 |
| 700-4-75        | 7314153017802 | 5 | 213 |
| 701-0-200       | 7314153017857 | 5 | 214 |
| 701-0-50        | 7314153017840 | 5 | 214 |
| 701-00-50       | 7314153017833 | 5 | 214 |
| 701-1-250       | 7314153017871 | 5 | 214 |
| 701-1-75        | 7314153017864 | 5 | 214 |
| 702-0-50        | 7314153017888 | 5 | 214 |
| 702-1-75        | 7314153017895 | 5 | 214 |
| 703-10-50       | 7314153017963 | 5 | 214 |
| 703-15-75       | 7314153017970 | 5 | 214 |
| 703-20-75       | 7314153017987 | 5 | 214 |
| 703-4-50        | 7314153017901 | 5 | 214 |
| 703-5-50        | 7314153017918 | 5 | 214 |
| 703-6-50        | 7314153017925 | 5 | 214 |
| 703-7-50        | 7314153017932 | 5 | 214 |
| 703-8-50        | 7314153017949 | 5 | 214 |
| 703-9-50        | 7314153017956 | 5 | 214 |
| 704-1.5-50      | 7314153017994 | 5 | 214 |
| 704-2-50        | 7314153018007 | 5 | 214 |
| 704-2.5-50      | 7314153018014 | 5 | 214 |
| 704-3-75        | 7314153018021 | 5 | 214 |
| 704Z-3/32       | 7314150137428 | 5 | 214 |
| 706-1           | 7314153018045 | 1 | 212 |
| 706-2           | 7314153018052 | 1 | 212 |
| 706-3           | 7314153018069 | 1 | 213 |
| 706-4           | 7314153018076 | 1 | 213 |
| 706-5           | 7314153018083 | 1 | 213 |
| 70S/1.2-8.0-2P  | 7314150262823 | 1 | 168 |
| 70S/1.6-10.0    | 7314150218394 | 1 | 168 |
| 70S/1.6-10.0-2P | 7314150261017 | 1 | 168 |
| 70S/1.6-9.0     | 7314150218400 | 1 | 168 |
| 70S/1.6-9.0-2P  | 7314150261024 | 1 | 168 |
| 70S/2.0-12.0    | 7314150218417 | 1 | 169 |
| 70S/2.0-12.0-2P | 7314150261086 | 1 | 169 |
| 70S/2.5-14.0    | 7314150218424 | 1 | 169 |
| 70S/2.5-14.0-2P | 7314150261147 | 1 | 169 |
| 70S/H10         | 7314150218486 | 1 | 169 |
| 70S/H10-2P      | 7314150261451 | 1 | 169 |
| 70S/H12         | 7314150218493 | 1 | 169 |
| 70S/H12-2P      | 7314150261468 | 1 | 169 |
| 70S/H14         | 7314150218509 | 1 | 169 |
| 70S/H14-2P      | 7314150261475 | 1 | 169 |
| 70S/H4          | 7314150218431 | 1 | 169 |
| 70S/H4-2P       | 7314150261352 | 1 | 169 |
| 70S/H5          | 7314150218448 | 1 | 169 |
| 70S/H5-2P       | 7314150261406 | 1 | 169 |
| 70S/H6          | 7314150218455 | 1 | 169 |
| 70S/H6-2P       | 7314150261437 | 1 | 169 |
| 70S/H7          | 7314150218462 | 1 | 169 |
| 70S/H7-2P       | 7314150261444 | 1 | 169 |
| 70S/H8-5P       | 7314150538782 | 1 | 169 |
| 70S/H8-2P       | 7314150262847 | 1 | 169 |
| 70S/PH1         | 7314150217557 | 1 | 169 |
| 70S/PH1-2P      | 7314150260621 | 1 | 169 |
| 70S/PH2         | 7314150217564 | 1 | 169 |
| 70S/PH2-2P      | 7314150260638 | 1 | 169 |
| 70S/PH3         | 7314150217571 | 1 | 169 |
| 70S/PH3-2P      | 7314150260645 | 1 | 169 |
| 70S/PH4         | 7314150217588 | 1 | 169 |
| 70S/PH4-2P      | 7314150260652 | 1 | 169 |
| 70S/PZ1         | 7314150217595 | 1 | 169 |
| 70S/PZ1-2P      | 7314150260683 | 1 | 169 |
| 70S/PZ2         | 7314150217601 | 1 | 169 |
| 70S/PZ2-2P      | 7314150260706 | 1 | 169 |
| 70S/PZ3         | 7314150217724 | 1 | 169 |
| 70S/PZ3-2P      | 7314150260720 | 1 | 169 |
| 70S/PZ4         | 7314150217731 | 1 | 169 |
| 70S/PZ4-2P      | 7314150260737 | 1 | 169 |
| 70S/T20         | 7314150217748 | 1 | 169 |
| 70S/T20-2P      | 7314150260744 | 1 | 169 |
| 70S/T25-2P      | 7314150260812 | 1 | 169 |
| 70S/T25-5P      | 7314150538508 | 1 | 169 |
| 70S/T27-5P      | 7314150538522 | 1 | 169 |
| 70S/T27-2P      | 7314150260867 | 1 | 169 |



|                |               |     |     |
|----------------|---------------|-----|-----|
| 70S/T30        | 7314150217779 | 1   | 169 |
| 70S/T30-2P     | 7314150260881 | 1   | 169 |
| 70S/T40-2P     | 7314150260898 | 1   | 169 |
| 70S/T45        | 7314150217793 | 1   | 169 |
| 70S/T45-2P     | 7314150260904 | 1   | 169 |
| 70S/T50        | 7314150217809 | 1   | 169 |
| 70S/T50-2P     | 7314150260911 | 1   | 169 |
| 70S/T55        | 7314150217816 | 1   | 169 |
| 70S/T55-2P     | 7314150260928 | 1   | 169 |
| 70S/TS1/4      | 7314150218349 | 1   | 169 |
| 70S/TS1/4-2P   | 7314150260935 | 1   | 169 |
| 70S/TS10       | 7314150218356 | 1   | 169 |
| 70S/TS10-2P    | 7314150260942 | 1   | 169 |
| 70S/TS5/16     | 7314150218363 | 1   | 169 |
| 70S/TS5/16-2P  | 7314150260959 | 1   | 169 |
| 70S/TS8        | 7314150218370 | 1   | 169 |
| 70S/TS8-2P     | 7314150260966 | 1   | 169 |
| 7106J          | 7314150339518 | 1   | 88  |
| 7154TC         | 7314150475148 | 10  | 649 |
| 7190           | 7314150052479 | 10  | 644 |
| 7190 CO        | 7314150052790 | 10  | 644 |
| 7191           | 7314150052509 | 10  | 644 |
| 7191 CO        | 7314150052806 | 10  | 644 |
| 7223           | 7314150237722 | 4   | 247 |
| 7223D          | 7314150421527 | 8   | 247 |
| 7223D IP       | 7314150440306 | 8   | 247 |
| 7223IP         | 7314150421855 | 8   | 247 |
| 7224           | 7311518274733 | 4   | 247 |
| 7224-622XD-3P  | 7314150426973 | 1   | 249 |
| 7224IP         | 7314150421831 | 4   | 247 |
| 7224S          | 7314150421657 | 4   | 501 |
| 7225           | 7314150237739 | 8   | 247 |
| 7225D          | 7314150421541 | 4   | 247 |
| 7225D IP       | 7314150440320 | 4   | 247 |
| 7225IP         | 7314150421848 | 4   | 247 |
| 7280           | 7314150052523 | 10  | 647 |
| 7285           | 7314150052530 | 10  | 647 |
| 7290           | 7314150052547 | 10  | 645 |
| 7291           | 7314150052554 | 10  | 645 |
| 7292           | 7314150052578 | 10  | 646 |
| 7292G          | 7314150434701 | 10  | 648 |
| 7293           | 7314150052592 | 10  | 646 |
| 7372I-2-63     | 7314151398668 | 10  | 218 |
| 7372I-2.5-75   | 7314151399047 | 10  | 218 |
| 7372I-3-80     | 7314151341602 | 10  | 218 |
| 7400SM-10      | 7314151092955 | 5   | 85  |
| 7400SM-11      | 7314151092962 | 5   | 85  |
| 7400SM-12      | 7314151092979 | 5   | 85  |
| 7400SM-13      | 7314151092986 | 5   | 85  |
| 7400SM-14      | 7314151092993 | 5   | 85  |
| 7400SM-15      | 7314151093006 | 5   | 85  |
| 7400SM-16      | 7314151831127 | 5   | 85  |
| 7400SM-17      | 7314151093020 | 5   | 85  |
| 7400SM-18      | 7314151831134 | 5   | 85  |
| 7400SM-19      | 7314151093044 | 5   | 85  |
| 7400SM-20      | 7314153002570 | 5   | 85  |
| 7400SM-21      | 7314153002587 | 5   | 85  |
| 7400SM-22      | 7314153002594 | 5   | 85  |
| 7400SM-6       | 7314151092917 | 5   | 85  |
| 7400SM-7       | 7314151092924 | 5   | 85  |
| 7400SM-8       | 7314151092931 | 5   | 85  |
| 7400SM-9       | 7314151092948 | 5   | 85  |
| 7400SR/S12     | 7314153003294 | 1   | 71  |
| 7400SZ-1/2     | 7314150385942 | 1   | 85  |
| 7400SZ-1/4     | 7314150385959 | 1   | 85  |
| 7400SZ-11/16   | 7314150385966 | 1   | 85  |
| 7400SZ-11/32   | 7314150385973 | 1   | 85  |
| 7400SZ-13/16   | 7314150385980 | 1   | 85  |
| 7400SZ-3/4     | 7314150385997 | 1   | 85  |
| 7400SZ-3/8     | 7314150386000 | 1   | 85  |
| 7400SZ-5/16    | 7314150386017 | 1   | 85  |
| 7400SZ-5/8     | 7314150386024 | 1   | 85  |
| 7400SZ-7/16    | 7314150386031 | 1   | 85  |
| 7400SZ-7/8     | 7314150386048 | 1   | 85  |
| 7400SZ-9/16    | 7314150386055 | 1   | 85  |
| 7400TORX-E10   | 7314153003058 | 5   | 86  |
| 7400TORX-E11   | 7314153003065 | 5   | 86  |
| 7400TORX-E12   | 7314153003072 | 5   | 86  |
| 7400TORX-E14   | 7314153003089 | 5   | 86  |
| 7400TORX-E16   | 7314153003096 | 5   | 86  |
| 7400TORX-E18   | 7314153003102 | 5   | 86  |
| 7400TORX-E8    | 7314150118243 | 5   | 86  |
| 7400TORX-ER/S7 | 7314153003300 | 1   | 71  |
| 7402GPR-16     | 7314150503087 | 120 | 307 |
| 7402GPR-18     | 7314150503094 | 120 | 307 |
| 7402GPR-21     | 7314150503100 | 100 | 307 |
| 7406ZZ-16      | 7314153011992 | 1   | 307 |
| 7406ZZ-21      | 7314153012005 | 1   | 307 |
| 7407H          | 7314151218249 | 1   | 173 |
| 7408H          | 7314151218300 | 1   | 173 |
| 7408MD         | 7314150220328 | 1   | 71  |
| 7409BH-10      | 7314153002112 | 5   | 90  |
| 7409BH-4       | 7314153002075 | 5   | 90  |
| 7409BH-5       | 7314153002082 | 1   | 90  |
| 7409BH-6       | 7314153002099 | 5   | 90  |
| 7409BH-8       | 7314153002105 | 5   | 90  |



|                  |               |     |    |
|------------------|---------------|-----|----|
| 7409F-10         | 7314153002143 | 5   | 89 |
| 7409F-6.5        | 7314153002129 | 5   | 89 |
| 7409F-8          | 7314153002136 | 5   | 89 |
| 7409H            | 7314151218355 | 173 | 1  |
| 7409M-10         | 7314153001962 | 5   | 90 |
| 7409M-3          | 7314153002235 | 5   | 90 |
| 7409M-4          | 7314153001900 | 5   | 90 |
| 7409M-5          | 7314153001917 | 5   | 90 |
| 7409M-6          | 7314153001924 | 5   | 90 |
| 7409M-7          | 7314153001931 | 5   | 90 |
| 7409M-8          | 7314153001948 | 5   | 90 |
| 7409MB           | 7314150220236 | 1   | 71 |
| 7409MR/S7        | 7314153003256 | 1   | 90 |
| 7409PH-1         | 7314153002150 | 5   | 89 |
| 7409PH-2         | 7314153002167 | 5   | 89 |
| 7409PH-3         | 7314153002174 | 5   | 89 |
| 7409TORX-R-T27   | 7314153001856 | 5   | 89 |
| 7409TORX-R-T30   | 7314153001863 | 5   | 89 |
| 7409TORX-R-T40   | 7314153001870 | 5   | 89 |
| 7409TORX-R-T45   | 7314153001887 | 5   | 89 |
| 7409TORX-R-T50   | 7314153001894 | 5   | 89 |
| 7409TORX-T20     | 7314150220403 | 5   | 89 |
| 7409TORX-T25     | 7314153001771 | 5   | 89 |
| 7409TORX-T25-L   | 7314153011237 | 5   | 90 |
| 7409TORX-T27     | 7314153001788 | 5   | 89 |
| 7409TORX-T30     | 7314153001795 | 5   | 89 |
| 7409TORX-T30-L   | 7314153011244 | 5   | 90 |
| 7409TORX-T40     | 7314153001801 | 5   | 89 |
| 7409TORX-T40-L   | 7314153011251 | 5   | 90 |
| 7409TORX-T45     | 7314153001818 | 5   | 89 |
| 7409TORX-T45-L   | 7314153011268 | 5   | 90 |
| 7409TORX-T50     | 7314153001825 | 5   | 89 |
| 7409TORX-T50-L   | 7314153011275 | 5   | 90 |
| 7409TORX-TRR/S5  | 7314153003263 | 1   | 89 |
| 7409Z-1/4        | 7314150386062 | 1   | 90 |
| 7409Z-1/8        | 7314150386079 | 1   | 90 |
| 7409Z-3/16       | 7314150386086 | 1   | 90 |
| 7409Z-3/8        | 7314150386093 | 1   | 90 |
| 7409Z-5/32       | 7314150386109 | 1   | 90 |
| 7409Z-7/32       | 7314150386116 | 1   | 90 |
| 7422MBR          | 7314150218844 | 1   | 71 |
| 7422MHR          | 7314150218868 | 1   | 71 |
| 7444SG-M-100     | 7314151830014 | 1   | 55 |
| 7444SG-M-105     | 7314151830021 | 1   | 55 |
| 7444SG-M-110     | 7314151830038 | 1   | 55 |
| 7444SG-M-115     | 7314151830045 | 1   | 55 |
| 7444SG-M-120     | 7314151830052 | 1   | 55 |
| 7444SG-M-125     | 7314151830069 | 1   | 55 |
| 7444SG-M-130     | 7314151830076 | 1   | 55 |
| 7444SG-M-135     | 7314151830083 | 1   | 55 |
| 7444SG-M-140     | 7314151830090 | 1   | 55 |
| 7444SG-M-145     | 7314151830106 | 1   | 55 |
| 7444SG-M-150     | 7314151830113 | 1   | 55 |
| 7444SG-M-155     | 7314151830120 | 1   | 55 |
| 7444SG-M-160     | 7314150132508 | 1   | 55 |
| 7444SG-M-165     | 7314150132515 | 1   | 55 |
| 7444SG-M-170     | 7314150132522 | 1   | 55 |
| 7444SG-M-175     | 7314150132539 | 1   | 55 |
| 7444SG-M-24      | 7314150205400 | 1   | 55 |
| 7444SG-M-27      | 7314151829834 | 1   | 55 |
| 7444SG-M-30      | 7314151829841 | 1   | 55 |
| 7444SG-M-32      | 7314151829858 | 1   | 55 |
| 7444SG-M-34      | 7314151838560 | 1   | 55 |
| 7444SG-M-36      | 7314151829865 | 1   | 55 |
| 7444SG-M-38      | 7314150180936 | 1   | 55 |
| 7444SG-M-41      | 7314151829872 | 1   | 55 |
| 7444SG-M-42      | 7314151829889 | 1   | 55 |
| 7444SG-M-46      | 7314151829896 | 1   | 55 |
| 7444SG-M-50      | 7314151829919 | 1   | 55 |
| 7444SG-M-55      | 7314151829926 | 1   | 55 |
| 7444SG-M-60      | 7314151829933 | 1   | 55 |
| 7444SG-M-65      | 7314151829940 | 1   | 55 |
| 7444SG-M-70      | 7314151829957 | 1   | 55 |
| 7444SG-M-75      | 7314151829964 | 1   | 55 |
| 7444SG-M-80      | 7314151829971 | 1   | 55 |
| 7444SG-M-85      | 7314151829988 | 1   | 55 |
| 7444SG-M-90      | 7314151829995 | 1   | 55 |
| 7444SG-M-95      | 7314151830007 | 1   | 55 |
| 7444SG-Z-1.1/16  | 7314150132546 | 1   | 55 |
| 7444SG-Z-1.1/2   | 7314150132614 | 1   | 55 |
| 7444SG-Z-1.1/4   | 7314150132577 | 1   | 55 |
| 7444SG-Z-1.1/8   | 7314150132553 | 1   | 55 |
| 7444SG-Z-1.11/16 | 7314150132638 | 1   | 55 |
| 7444SG-Z-1.13/16 | 7314150132652 | 1   | 55 |
| 7444SG-Z-1.3/16  | 7314150132560 | 1   | 55 |
| 7444SG-Z-1.3/4   | 7314150132645 | 1   | 55 |
| 7444SG-Z-1.3/8   | 7314150132591 | 1   | 55 |
| 7444SG-Z-1.5/16  | 7314150132584 | 1   | 55 |
| 7444SG-Z-1.5/8   | 7314150132621 | 1   | 55 |
| 7444SG-Z-1.7/16  | 7314150132607 | 1   | 55 |
| 7444SG-Z-1.7/8   | 7314150132669 | 1   | 55 |
| 7444SG-Z-2       | 7314150132676 | 1   | 55 |
| 7444SG-Z-2.1/16  | 7314150132683 | 1   | 55 |
| 7444SG-Z-2.1/4   | 7314150132713 | 1   | 55 |
| 7444SG-Z-2.1/8   | 7314150132690 | 1   | 55 |
| 7444SG-Z-2.3/16  | 7314150132706 | 1   | 55 |



|                 |               |   |     |
|-----------------|---------------|---|-----|
| 7444SG-Z-2.3/4  | 7314150132768 | 1 | 55  |
| 7444SG-Z-2.3/8  | 7314150132720 | 1 | 55  |
| 7444SG-Z-2.5/8  | 7314150132751 | 1 | 55  |
| 7444SG-Z-2.9/16 | 7314150132744 | 1 | 55  |
| 7444SG-Z-3      | 7314150132775 | 1 | 55  |
| 7444SG-Z-3.1/2  | 7314150132805 | 1 | 55  |
| 7444SG-Z-3.1/8  | 7314150132782 | 1 | 55  |
| 7444SG-Z-3.3/4  | 7314150132812 | 1 | 55  |
| 7444SG-Z-3.3/8  | 7314150132799 | 1 | 55  |
| 7444SG-Z-3.7/8  | 7314150132829 | 1 | 55  |
| 7444SG-Z-4      | 7314150132836 | 1 | 55  |
| 7444SG-Z-4.1/2  | 7314150132850 | 1 | 55  |
| 7444SG-Z-4.1/8  | 7314150132843 | 1 | 55  |
| 7454-1400       | 7314150119592 | 1 | 109 |
| 7454-1400E      | 7314150119615 | 1 | 109 |
| 7454-140A       | 7314150509515 | 1 | 108 |
| 7454-17         | 7314150509492 | 1 | 108 |
| 7454-230        | 7314150509522 | 1 | 108 |
| 7454-3.5        | 7314150509478 | 1 | 108 |
| 7454-32         | 7314150509508 | 1 | 108 |
| 7454-480        | 7314150119578 | 1 | 109 |
| 7454-70A        | 7314150509577 | 1 | 108 |
| 7454-8.4        | 7314150509485 | 1 | 108 |
| 7454-800A       | 7314150509584 | 1 | 108 |
| 7454-800E       | 7314150119608 | 1 | 109 |
| 7455-100        | 7314150125111 | 1 | 106 |
| 7455-1000       | 7314150368303 | 1 | 106 |
| 7455-100A       | 7314150340156 | 1 | 106 |
| 7455-15         | 7314150119646 | 1 | 106 |
| 7455-1500       | 7314150125166 | 1 | 107 |
| 7455-20         | 7314150125074 | 1 | 106 |
| 7455-200        | 7314150125128 | 1 | 106 |
| 7455-25         | 7314150125081 | 1 | 106 |
| 7455-2500       | 7314150125173 | 1 | 107 |
| 7455-300        | 7314150125104 | 1 | 106 |
| 7455-340        | 7314150125135 | 1 | 106 |
| 7455-5          | 7314150119639 | 1 | 106 |
| 7455-500        | 7314150125142 | 1 | 106 |
| 7455-60         | 7314150125098 | 1 | 106 |
| 7455-800        | 7314150125159 | 1 | 106 |
| 7456-80LB       | 7314150119783 | 1 | 107 |
| 7465-100        | 7314150340200 | 1 | 107 |
| 7465-15         | 7314150340170 | 1 | 107 |
| 7465-1500       | 7314150340248 | 1 | 107 |
| 7465-200        | 7314150340217 | 1 | 107 |
| 7465-30         | 7314150340187 | 1 | 107 |
| 7465-340        | 7314150340224 | 1 | 107 |
| 7465-5          | 7314150340163 | 1 | 107 |
| 7465-60         | 7314150340194 | 1 | 107 |
| 7465-800        | 7314150340231 | 1 | 107 |
| 747-1           | 7314150362899 | 1 | 51  |
| 747-1.1/16      | 7314150362905 | 1 | 51  |
| 747-1.1/2       | 7314150362974 | 1 | 51  |
| 747-1.1/4       | 7314150362936 | 1 | 51  |
| 747-1.1/8       | 7314150362912 | 1 | 51  |
| 747-1.11/16     | 7314150363001 | 1 | 51  |
| 747-1.13/16     | 7314150363025 | 1 | 51  |
| 747-1.15/16     | 7314150363049 | 1 | 51  |
| 747-1.3/16      | 7314150362929 | 1 | 51  |
| 747-1.3/4       | 7314150363018 | 1 | 51  |
| 747-1.3/8       | 7314150362950 | 1 | 51  |
| 747-1.5/16      | 7314150362943 | 1 | 51  |
| 747-1.5/8       | 7314150362998 | 1 | 51  |
| 747-1.7/16      | 7314150362967 | 1 | 51  |
| 747-1.7/8       | 7314150363032 | 1 | 51  |
| 747-1.9/16      | 7314150362981 | 1 | 51  |
| 747-1/2         | 7314150362813 | 1 | 51  |
| 747-10          | 7314150362516 | 1 | 51  |
| 747-11          | 7314150362523 | 1 | 51  |
| 747-11/16       | 7314150362844 | 1 | 51  |
| 747-12          | 7314150362530 | 1 | 51  |
| 747-13          | 7314150362547 | 1 | 51  |
| 747-13/16       | 7314150362868 | 1 | 51  |
| 747-14          | 7314150362554 | 1 | 51  |
| 747-15          | 7314150362561 | 1 | 51  |
| 747-15/16       | 7314150362882 | 1 | 51  |
| 747-16          | 7314150362578 | 1 | 51  |
| 747-17          | 7314150362585 | 1 | 51  |
| 747-18          | 7314150362592 | 1 | 51  |
| 747-19          | 7314150362608 | 1 | 51  |
| 747-2           | 7314150363056 | 1 | 51  |
| 747-2.1/16      | 7314150363063 | 1 | 51  |
| 747-2.1/2       | 7314150363131 | 1 | 51  |
| 747-2.1/4       | 7314150363094 | 1 | 51  |
| 747-2.1/8       | 7314150363070 | 1 | 51  |
| 747-2.3/16      | 7314150364893 | 1 | 51  |
| 747-2.3/4       | 7314150363162 | 1 | 51  |
| 747-2.3/8       | 7314150363117 | 1 | 51  |
| 747-2.5/16      | 7314150363100 | 1 | 51  |
| 747-2.5/8       | 7314150363155 | 1 | 51  |
| 747-2.7/16      | 7314150363124 | 1 | 51  |
| 747-2.7/8       | 7314150363179 | 1 | 51  |
| 747-2.9/16      | 7314150363148 | 1 | 51  |
| 747-20          | 7314150362615 | 1 | 51  |
| 747-21          | 7314150362622 | 1 | 51  |
| 747-22          | 7314150362639 | 1 | 51  |







|             |               |    |     |
|-------------|---------------|----|-----|
| 747-23      | 7314150362646 | 1  | 51  |
| 747-24      | 7314150362653 | 1  | 51  |
| 747-25      | 7314150362660 | 1  | 51  |
| 747-26      | 7314150362677 | 1  | 51  |
| 747-27      | 7314150362684 | 1  | 51  |
| 747-28      | 7314150362691 | 1  | 51  |
| 747-3/4     | 7314150362851 | 1  | 51  |
| 747-3/8     | 7314150362790 | 1  | 51  |
| 747-30      | 7314150362707 | 1  | 51  |
| 747-32      | 7314150362714 | 1  | 51  |
| 747-34      | 7314150362721 | 1  | 51  |
| 747-36      | 7314150362738 | 1  | 51  |
| 747-40      | 7314150362745 | 1  | 51  |
| 747-41      | 7314150362752 | 1  | 51  |
| 747-42      | 7314150362769 | 1  | 51  |
| 747-46      | 7314150362776 | 1  | 51  |
| 747-5/8     | 7314150362837 | 1  | 51  |
| 747-50      | 7314150362783 | 1  | 51  |
| 747-7/16    | 7314150362806 | 1  | 51  |
| 747-7/8     | 7314150362875 | 1  | 51  |
| 747-9/16    | 7314150362820 | 1  | 51  |
| 749-1       | 7314150363506 | 1  | 54  |
| 749-1.1/16  | 7314150363513 | 1  | 54  |
| 749-1.1/2   | 7314150363582 | 1  | 54  |
| 749-1.1/4   | 7314150363544 | 1  | 54  |
| 749-1.1/8   | 7314150363520 | 1  | 54  |
| 749-1.11/16 | 7314150363612 | 1  | 54  |
| 749-1.13/16 | 7314150363636 | 1  | 54  |
| 749-1.15/16 | 7314150363650 | 1  | 54  |
| 749-1.3/16  | 7314150363537 | 1  | 54  |
| 749-1.3/4   | 7314150363629 | 1  | 54  |
| 749-1.3/8   | 7314150363568 | 1  | 54  |
| 749-1.5/16  | 7314150363551 | 1  | 54  |
| 749-1.5/8   | 7314150363605 | 1  | 54  |
| 749-1.7/16  | 7314150363575 | 1  | 54  |
| 749-1.7/8   | 7314150363643 | 1  | 54  |
| 749-1.9/16  | 7314150363599 | 1  | 54  |
| 749-1/2     | 7314150363421 | 1  | 54  |
| 749-10      | 7314150538386 | 10 | 54  |
| 749-11      | 7314150538362 | 10 | 54  |
| 749-11/16   | 7314150363452 | 1  | 54  |
| 749-13      | 7314150538348 | 10 | 54  |
| 749-13/16   | 7314150363476 | 1  | 54  |
| 749-14      | 7314150538324 | 10 | 54  |
| 749-15      | 7314150357543 | 1  | 54  |
| 749-15/16   | 7314150363490 | 1  | 54  |
| 749-16      | 7314150357550 | 1  | 54  |
| 749-17      | 7314150357567 | 1  | 54  |
| 749-18      | 7314150357574 | 1  | 54  |
| 749-19      | 7314150357581 | 1  | 54  |
| 749-2       | 7314150363667 | 1  | 54  |
| 749-2.1/4   | 7314150363698 | 1  | 54  |
| 749-2.1/8   | 7314150363674 | 1  | 54  |
| 749-2.3/16  | 7314150363681 | 1  | 54  |
| 749-2.3/4   | 7314150363728 | 1  | 54  |
| 749-2.3/8   | 7314150363704 | 1  | 54  |
| 749-2.5/8   | 7314150363711 | 1  | 54  |
| 749-20      | 7314150357598 | 1  | 54  |
| 749-21      | 7314150357604 | 1  | 54  |
| 749-22      | 7314150357611 | 1  | 54  |
| 749-23      | 7314150357628 | 1  | 54  |
| 749-24      | 7314150357635 | 1  | 54  |
| 749-25      | 7314150357642 | 1  | 54  |
| 749-26      | 7314150357659 | 1  | 54  |
| 749-27      | 7314150357666 | 1  | 54  |
| 749-3.1/8   | 7314150363735 | 1  | 54  |
| 749-3/4     | 7314150363469 | 1  | 54  |
| 749-3/8     | 7314150363407 | 1  | 54  |
| 749-5/8     | 7314150363445 | 1  | 54  |
| 749-7/16    | 7314150363414 | 1  | 54  |
| 749-7/8     | 7314150363483 | 1  | 54  |
| 749-9/16    | 7314150363438 | 1  | 54  |
| 7490        | 7314150052646 | 10 | 650 |
| 7490 CO     | 7314150052875 | 10 | 650 |
| 74P14-200   | 7314150416318 | 1  | 110 |
| 74P14-300   | 7314150416325 | 1  | 110 |
| 74P14-400   | 7314150416332 | 1  | 110 |
| 74P9-100    | 7314150416301 | 1  | 110 |
| 74P9-20     | 7314150416288 | 1  | 110 |
| 74P9-60     | 7314150416295 | 1  | 110 |
| 74PR-100    | 7314150416189 | 1  | 109 |
| 74PR-100A   | 7314150416196 | 1  | 109 |
| 74PR-20     | 7314150416158 | 1  | 109 |
| 74PR-200    | 7314150416202 | 1  | 109 |
| 74PR-300    | 7314150416219 | 1  | 109 |
| 74PR-400    | 7314150416226 | 1  | 109 |
| 74PR-60     | 7314150416165 | 1  | 109 |
| 74PR-60A    | 7314150416172 | 1  | 109 |
| 74PS-100    | 7314150416257 | 1  | 110 |
| 74PS-20     | 7314150416233 | 1  | 110 |
| 74PS-200    | 7314150416264 | 1  | 110 |
| 74PS-300    | 7314150416271 | 1  | 110 |
| 74PS-60     | 7314150416240 | 1  | 110 |
| 74S/H10     | 7314150218622 | 1  | 164 |
| 74S/H10-2P  | 7314150261635 | 1  | 164 |
| 74S/H12     | 7314150218639 | 1  | 164 |



|              |               |    |     |
|--------------|---------------|----|-----|
| 74S/H12-2P   | 7314150261659 | 1  | 164 |
| 74S/H14      | 7314150218646 | 1  | 164 |
| 74S/H14-2P   | 7314150261666 | 1  | 164 |
| 74S/H17      | 7314150218653 | 1  | 164 |
| 74S/H17-2P   | 7314150261673 | 1  | 164 |
| 74S/H4       | 7314150218578 | 1  | 164 |
| 74S/H4-2P    | 7314150261543 | 1  | 164 |
| 74S/H5       | 7314150218585 | 1  | 164 |
| 74S/H5-2P    | 7314150261550 | 1  | 164 |
| 74S/H6       | 7314150218592 | 1  | 164 |
| 74S/H6-2P    | 7314150261567 | 1  | 164 |
| 74S/H7       | 7314150218608 | 1  | 164 |
| 74S/H7-2P    | 7314150261574 | 1  | 164 |
| 74S/H8       | 7314150218615 | 1  | 164 |
| 74S/H8-2P    | 7314150261611 | 1  | 164 |
| 74W14-200    | 7314150415700 | 1  | 106 |
| 74W14-300    | 7314150415717 | 1  | 106 |
| 74W14-400    | 7314150415724 | 1  | 106 |
| 74W9-100     | 7314150415687 | 1  | 106 |
| 74W9-15      | 7314150415656 | 1  | 106 |
| 74W9-200     | 7314150415694 | 1  | 106 |
| 74W9-25      | 7314150415663 | 1  | 106 |
| 74W9-50      | 7314150415670 | 1  | 106 |
| 74WR-100     | 7314150415540 | 1  | 106 |
| 74WR-100B    | 7314150469871 | 1  | 106 |
| 74WR-15      | 7314150415519 | 1  | 106 |
| 74WR-200     | 7314150415557 | 1  | 106 |
| 74WR-25      | 7314150415526 | 1  | 106 |
| 74WR-300     | 7314150415564 | 1  | 106 |
| 74WR-340     | 7314150415571 | 1  | 106 |
| 74WR-400     | 7314150415588 | 1  | 106 |
| 74WR-50      | 7314150415533 | 1  | 106 |
| 74WS-100     | 7314150415625 | 1  | 106 |
| 74WS-15      | 7314150415595 | 1  | 106 |
| 74WS-200     | 7314150415632 | 1  | 106 |
| 74WS-25      | 7314150415601 | 1  | 106 |
| 74WS-300     | 7314150415649 | 1  | 106 |
| 74WS-50      | 7314150415618 | 1  | 106 |
| 7590         | 7314150052660 | 10 | 650 |
| 7590 CO      | 7314150052882 | 10 | 650 |
| 7591         | 7314150197491 | 1  | 650 |
| 75EXT        | 7314150415311 | 1  | 111 |
| 75P1-1500    | 7314150415298 | 1  | 110 |
| 75P3-1000    | 7314150415281 | 1  | 110 |
| 75P3-650     | 7314150415267 | 1  | 110 |
| 75P3-800     | 7314150415274 | 1  | 110 |
| 75PS-650     | 7314150415328 | 1  | 110 |
| 75R1-1500    | 7314150415236 | 1  | 107 |
| 75R3-1000    | 7314150415229 | 1  | 107 |
| 75R3-650     | 7314150415205 | 1  | 107 |
| 75R3-800     | 7314150415212 | 1  | 107 |
| 75S-650      | 7314150415243 | 1  | 108 |
| 76R1-2000    | 7314150522378 | 1  | 108 |
| 76R3-1000    | 7314150422128 | 1  | 108 |
| 76R3-1500    | 7314150422135 | 1  | 108 |
| 76R3-600     | 7314150423118 | 1  | 108 |
| 76R3-800     | 7314150422111 | 1  | 108 |
| 76S-600      | 7314150423125 | 1  | 108 |
| 7710         | 7314151551445 | 1  | 89  |
| 7750         | 7314151096427 | 1  | 88  |
| 7750-SPARE   | 7314150187874 | 1  | 91  |
| 7750RN       | 7314151831240 | 1  | 88  |
| 7750RN-SPARE | 7314150209361 | 1  | 91  |
| 7750SL       | 7314150197675 | 1  | 88  |
| 7750SL-SPARE | 7314150210268 | 1  | 90  |
| 7751         | 7314150386949 | 10 | 90  |
| 7752         | 7314151096533 | 1  | 86  |
| 7754         | 7314151096557 | 1  | 87  |
| 7756         | 7314150489152 | 6  | 87  |
| 7758-10      | 7314150470891 | 1  | 87  |
| 7759         | 7314151096601 | 1  | 87  |
| 7760         | 7314151096618 | 1  | 87  |
| 7760W-3      | 7314150470907 | 10 | 87  |
| 7760W-6      | 7314150470914 | 10 | 87  |
| 7761         | 7314151096632 | 1  | 87  |
| 7762         | 7314151096649 | 1  | 87  |
| 7764         | 7314151096670 | 1  | 88  |
| 7765         | 7314151096687 | 1  | 81  |
| 7766         | 7314151096694 | 1  | 87  |
| 7767         | 7314153003577 | 1  | 82  |
| 7768         | 7314150128433 | 1  | 87  |
| 776EX-01     | 7314150386130 | 1  | 87  |
| 776EX-03     | 7314150386154 | 1  | 87  |
| 776EX-04     | 7314150386161 | 1  | 87  |
| 776EX-06     | 7314150386178 | 1  | 87  |
| 776EX-08     | 7314150386185 | 1  | 87  |
| 776EX-11     | 7314150386147 | 1  | 87  |
| 7772H        | 7314150476336 | 10 | 93  |
| 7773A        | 7314150512270 | 20 | 88  |
| 7800DM-10    | 7314151096991 | 10 | 92  |
| 7800DM-11    | 7314151097011 | 10 | 92  |
| 7800DM-12    | 7314151097035 | 10 | 92  |
| 7800DM-13    | 7314151097059 | 10 | 92  |
| 7800DM-14    | 7314151097073 | 10 | 92  |
| 7800DM-15    | 7314151097097 | 10 | 92  |
| 7800DM-16    | 7314151097110 | 10 | 92  |

| Part Number   | Part Number   | Quantity | Part Number | Quantity |
|---------------|---------------|----------|-------------|----------|
| 7800DM-17     | 7314151097134 | 10       | 92          |          |
| 7800DM-18     | 7314151097158 | 10       | 92          |          |
| 7800DM-19     | 7314151097172 | 10       | 92          |          |
| 7800DM-20     | 7314151097196 | 10       | 92          |          |
| 7800DM-21     | 7314151097219 | 10       | 92          |          |
| 7800DM-22     | 7314151097233 | 10       | 92          |          |
| 7800DM-23     | 7314151097257 | 10       | 92          |          |
| 7800DM-24     | 7314151097271 | 10       | 92          |          |
| 7800DM-25     | 7314151097295 | 10       | 92          |          |
| 7800DM-26     | 7314151097318 | 10       | 92          |          |
| 7800DM-27     | 7314151097332 | 10       | 92          |          |
| 7800DM-28     | 7314151097356 | 10       | 92          |          |
| 7800DM-29     | 7314151097363 | 10       | 92          |          |
| 7800DM-30     | 7314151097370 | 10       | 92          |          |
| 7800DM-31     | 7314150464548 | 10       | 92          |          |
| 7800DM-32     | 7314151097387 | 10       | 92          |          |
| 7800DM-33     | 7314150169351 | 10       | 92          |          |
| 7800DM-34     | 7314150169405 | 10       | 92          |          |
| 7800DM-36     | 7314151097400 | 10       | 92          |          |
| 7800DM-8      | 7314151830854 | 10       | 92          |          |
| 7800DM-9      | 7314151830861 | 10       | 92          |          |
| 7800DMV-10    | 7314150121656 | 10       | 502         |          |
| 7800DMV-11    | 7314150121663 | 10       | 502         |          |
| 7800DMV-12    | 7314150121670 | 10       | 502         |          |
| 7800DMV-13    | 7314150121687 | 10       | 502         |          |
| 7800DMV-14    | 7314150121694 | 10       | 502         |          |
| 7800DMV-15    | 7314150121700 | 10       | 502         |          |
| 7800DMV-16    | 7314150121717 | 10       | 502         |          |
| 7800DMV-17    | 7314150121724 | 10       | 502         |          |
| 7800DMV-18    | 7314150121731 | 10       | 502         |          |
| 7800DMV-19    | 7314150121748 | 10       | 502         |          |
| 7800DMV-20    | 7314150121755 | 10       | 502         |          |
| 7800DMV-21    | 7314150121762 | 10       | 502         |          |
| 7800DMV-22    | 7314150121779 | 10       | 502         |          |
| 7800DMV-24    | 7314150121786 | 5        | 502         |          |
| 7800DMV-27    | 7314150121793 | 5        | 502         |          |
| 7800DMV-30    | 7314150121809 | 5        | 502         |          |
| 7800DMV-32    | 7314150121816 | 5        | 502         |          |
| 7800DMV-8     | 7314150121649 | 10       | 502         |          |
| 7800DZ-1      | 7314151097561 | 10       | 92          |          |
| 7800DZ-1.1/16 | 7314151097578 | 10       | 92          |          |
| 7800DZ-1.1/2  | 7314150464562 | 10       | 92          |          |
| 7800DZ-1.1/4  | 7314151097608 | 10       | 92          |          |
| 7800DZ-1.1/8  | 7314151097585 | 10       | 92          |          |
| 7800DZ-1.3/16 | 7314151097592 | 10       | 92          |          |
| 7800DZ-1.3/8  | 7314150464586 | 10       | 92          |          |
| 7800DZ-1.5/16 | 7314150166077 | 10       | 92          |          |
| 7800DZ-1.7/16 | 7314150464609 | 1        | 92          |          |
| 7800DZ-1/2    | 7314151097455 | 10       | 92          |          |
| 7800DZ-11/16  | 7314151097493 | 10       | 92          |          |
| 7800DZ-11/32  | 7314150465712 | 10       | 92          |          |
| 7800DZ-13/16  | 7314151097523 | 10       | 92          |          |
| 7800DZ-13/32  | 7314150464623 | 10       | 92          |          |
| 7800DZ-15/16  | 7314151097554 | 10       | 92          |          |
| 7800DZ-19/32  | 7314151097479 | 10       | 92          |          |
| 7800DZ-25/32  | 7314151097516 | 10       | 92          |          |
| 7800DZ-3/4    | 7314151097509 | 10       | 92          |          |
| 7800DZ-3/8    | 7314151097431 | 10       | 92          |          |
| 7800DZ-5/16   | 7314150464647 | 10       | 92          |          |
| 7800DZ-5/8    | 7314151097486 | 10       | 92          |          |
| 7800DZ-7/16   | 7314151097448 | 10       | 92          |          |
| 7800DZ-7/8    | 7314151097530 | 10       | 92          |          |
| 7800DZ-9/16   | 7314151097462 | 10       | 92          |          |
| 7800SM-10     | 7314151097851 | 10       | 91          |          |
| 7800SM-11     | 7314151097868 | 10       | 91          |          |
| 7800SM-12     | 7314151097875 | 10       | 91          |          |
| 7800SM-13     | 7314151097882 | 10       | 91          |          |
| 7800SM-14     | 7314151097899 | 10       | 91          |          |
| 7800SM-15     | 7314151097905 | 10       | 91          |          |
| 7800SM-16     | 7314151097912 | 10       | 91          |          |
| 7800SM-17     | 7314151097929 | 10       | 91          |          |
| 7800SM-18     | 7314151097936 | 10       | 91          |          |
| 7800SM-19     | 7314151097943 | 10       | 91          |          |
| 7800SM-20     | 7314150166206 | 10       | 91          |          |
| 7800SM-21     | 7314151097967 | 10       | 91          |          |
| 7800SM-22     | 7314151097974 | 10       | 91          |          |
| 7800SM-23     | 7314151097981 | 10       | 91          |          |
| 7800SM-24     | 7314151097998 | 10       | 91          |          |
| 7800SM-25     | 7314151098001 | 10       | 91          |          |
| 7800SM-26     | 7314151830823 | 10       | 91          |          |
| 7800SM-27     | 7314151098025 | 10       | 91          |          |
| 7800SM-28     | 7314151830830 | 10       | 91          |          |
| 7800SM-29     | 7314150166213 | 10       | 91          |          |
| 7800SM-30     | 7314151098056 | 10       | 91          |          |
| 7800SM-32     | 7314151098063 | 10       | 91          |          |
| 7800SM-33     | 7314150167319 | 10       | 91          |          |
| 7800SM-34     | 7314153011305 | 10       | 91          |          |
| 7800SM-36     | 7314151098087 | 10       | 91          |          |
| 7800SM-8      | 7314151830793 | 10       | 91          |          |
| 7800SM-9      | 7314151830809 | 10       | 91          |          |
| 7800SZ-1.3/16 | 7314150528387 | 10       | 92          |          |
| 7800SZ-1/2    | 7314150528400 | 10       | 92          |          |
| 7800SZ-11/16  | 7314150528424 | 10       | 92          |          |
| 7800SZ-13/16  | 7314150528448 | 10       | 92          |          |
| 7800SZ-3/4    | 7314150528462 | 10       | 92          |          |
| 7800SZ-3/8    | 7314150528486 | 10       | 92          |          |

| Part Number   | Part Number   | Quantity | Part Number | Quantity |
|---------------|---------------|----------|-------------|----------|
| 7800SZ-7/16   | 7314150528509 | 10       | 92          |          |
| 7800SZ-7/8    | 7314150528523 | 10       | 92          |          |
| 7800SZ-9/16   | 7314150528547 | 10       | 92          |          |
| 7800TORX-E10  | 7314150166084 | 1        | 93          |          |
| 7800TORX-E11  | 7314150220359 | 1        | 93          |          |
| 7800TORX-E12  | 7314153011800 | 1        | 93          |          |
| 7800TORX-E14  | 7314153011756 | 1        | 93          |          |
| 7800TORX-E16  | 7314153011763 | 1        | 93          |          |
| 7800TORX-E18  | 7314153011770 | 1        | 93          |          |
| 7800TORX-E20  | 7314153011787 | 1        | 93          |          |
| 7800TORX-E24  | 7314153011794 | 1        | 93          |          |
| 7800TORX-E8   | 7314150166091 | 1        | 93          |          |
| 7800TORX/9    | 7314150469741 | 1        | 96          |          |
| 7805DM-10     | 7314151822101 | 10       | 92          |          |
| 7805DM-12     | 7314151098452 | 10       | 92          |          |
| 7805DM-13     | 7314151098469 | 10       | 92          |          |
| 7805DM-14     | 7314151098476 | 10       | 92          |          |
| 7805DM-15     | 7314151098483 | 10       | 92          |          |
| 7805DM-16     | 7314151098490 | 10       | 92          |          |
| 7805DM-17     | 7314151098506 | 10       | 92          |          |
| 7805DM-18     | 7314151098513 | 10       | 92          |          |
| 7805DM-19     | 7314151098520 | 10       | 92          |          |
| 7805DM-21     | 7314151098544 | 10       | 92          |          |
| 7805DM-22     | 7314151098551 | 10       | 92          |          |
| 7805DM-23     | 7314150313532 | 10       | 92          |          |
| 7805DM-24     | 7314151098568 | 10       | 92          |          |
| 7805DM-26     | 7314151098582 | 10       | 92          |          |
| 7805DM-27     | 7314151098599 | 10       | 92          |          |
| 7805DM-30     | 7314151098605 | 10       | 92          |          |
| 7805DM-32     | 7314150220281 | 10       | 92          |          |
| 7805DM-34     | 7314150488537 | 10       | 92          |          |
| 7805DZ-1      | 7314150357758 | 10       | 93          |          |
| 7805DZ-1.1/16 | 7314150357765 | 10       | 93          |          |
| 7805DZ-1.1/2  | 7314150357833 | 10       | 93          |          |
| 7805DZ-1.1/4  | 7314150357796 | 10       | 93          |          |
| 7805DZ-1.1/8  | 7314150357772 | 10       | 93          |          |
| 7805DZ-1.3/16 | 7314150357789 | 10       | 93          |          |
| 7805DZ-1.3/8  | 7314150357819 | 10       | 93          |          |
| 7805DZ-1.5/16 | 7314150357802 | 10       | 93          |          |
| 7805DZ-1.7/16 | 7314150357826 | 10       | 93          |          |
| 7805DZ-11/16  | 7314150357703 | 10       | 93          |          |
| 7805DZ-13/16  | 7314150357727 | 10       | 93          |          |
| 7805DZ-15/16  | 7314150357741 | 10       | 93          |          |
| 7805DZ-3/4    | 7314150357710 | 10       | 93          |          |
| 7805DZ-5/8    | 7314150357697 | 10       | 93          |          |
| 7805DZ-7/8    | 7314150357734 | 10       | 93          |          |
| 7805GPR-16    | 7314150503117 | 120      | 307         |          |
| 7805GPR-21    | 7314150503124 | 100      | 307         |          |
| 7805SM-10     | 7314153011312 | 10       | 91          |          |
| 7805SM-11     | 7314150475926 | 10       | 91          |          |
| 7805SM-12     | 7314153011329 | 10       | 91          |          |
| 7805SM-13     | 7314153011336 | 10       | 91          |          |
| 7805SM-14     | 7314153011343 | 10       | 91          |          |
| 7805SM-15     | 7314153011350 | 10       | 91          |          |
| 7805SM-16     | 7314153011367 | 10       | 91          |          |
| 7805SM-17     | 7314153011374 | 10       | 91          |          |
| 7805SM-18     | 7314153011381 | 10       | 91          |          |
| 7805SM-19     | 7314153011398 | 10       | 91          |          |
| 7805SM-20     | 7314153011404 | 10       | 91          |          |
| 7805SM-21     | 7314153011411 | 10       | 91          |          |
| 7805SM-22     | 7314153011428 | 10       | 91          |          |
| 7805SM-23     | 7314153011435 | 10       | 91          |          |
| 7805SM-24     | 7314153011442 | 10       | 91          |          |
| 7805SM-25     | 7314153011459 | 10       | 91          |          |
| 7805SM-26     | 7314153011466 | 10       | 91          |          |
| 7805SM-27     | 7314153011473 | 10       | 91          |          |
| 7805SM-28     | 7314153011480 | 10       | 91          |          |
| 7805SM-29     | 7314153011497 | 10       | 91          |          |
| 7805SM-30     | 7314153011503 | 10       | 91          |          |
| 7805SM-32     | 7314153011527 | 10       | 91          |          |
| 7805SM-34     | 7314153024251 | 10       | 91          |          |
| 7805SZ-1.1/2  | 7314150357987 | 1        | 91          |          |
| 7805SZ-1.1/4  | 7314150357949 | 1        | 91          |          |
| 7805SZ-1.3/16 | 7314150357932 | 1        | 91          |          |
| 7805SZ-1.3/8  | 7314150357963 | 1        | 91          |          |
| 7805SZ-1.5/16 | 7314150357956 | 1        | 91          |          |
| 7805SZ-1.7/16 | 7314150357970 | 1        | 91          |          |
| 7806MD        | 7314150220335 | 1        | 76          |          |
| 7807H         | 7314151232764 | 1        | 177         |          |
| 7807TE        | 7314150313792 | 1        | 76          |          |
| 7808H         | 7314151232771 | 1        | 177         |          |
| 7808HM        | 7314150220434 | 1        | 96          |          |
| 7809F-10      | 7314151830892 | 5        | 95          |          |
| 7809F-8       | 7314151830885 | 5        | 95          |          |
| 7809H         | 7314151232788 | 1        | 177         |          |
| 7809HL        | 7314150128464 | 1        | 95          |          |
| 7809M-10      | 7314151815608 | 1        | 96          |          |
| 7809M-10-120  | 7314150509669 | 1        | 96          |          |
| 7809M-12      | 7314151815615 | 1        | 96          |          |
| 7809M-12-120  | 7314150509683 | 1        | 96          |          |
| 7809M-14      | 7314151815622 | 1        | 96          |          |
| 7809M-14-120  | 7314150509706 | 10       | 96          |          |
| 7809M-17      | 7314151831028 | 1        | 96          |          |
| 7809M-17-120  | 7314150509720 | 1        | 96          |          |
| 7809M-19      | 7314151831035 | 1        | 96          |          |
| 7809M-19-120  | 7314150516575 | 8        | 96          |          |





# 7809M-4



|                  |               |     |     |
|------------------|---------------|-----|-----|
| 7809M-4          | 7314150214600 | 10  | 96  |
| 7809M-4-120      | 7314150509591 | 1   | 96  |
| 7809M-5          | 7314151815561 | 1   | 96  |
| 7809M-5-120      | 7314150509607 | 1   | 96  |
| 7809M-5-180      | 7314151830922 | 1   | 96  |
| 7809M-6          | 7314151815578 | 1   | 96  |
| 7809M-6-120      | 7314150509621 | 1   | 96  |
| 7809M-7          | 7314151815585 | 1   | 96  |
| 7809M-7-100      | 7314151830960 | 1   | 96  |
| 7809M-8          | 7314151815592 | 1   | 96  |
| 7809M-8-120      | 7314151830984 | 1   | 96  |
| 7809M-9          | 7314151830991 | 1   | 96  |
| 7809M/10         | 7314151831448 | 1   | 73  |
| 7809PH-2         | 7314151830908 | 1   | 95  |
| 7809PH-3         | 7314151830915 | 1   | 95  |
| 7809PH-4         | 7314153003423 | 1   | 95  |
| 7809PZ-2         | 7314153003430 | 1   | 95  |
| 7809PZ-3         | 7314153003447 | 1   | 95  |
| 7809TO           | 7314150220465 | 1   | 96  |
| 7809TORX-T20     | 7314151811730 | 1   | 95  |
| 7809TORX-T20-120 | 7314150509768 | 1   | 96  |
| 7809TORX-T25     | 7314151811747 | 1   | 95  |
| 7809TORX-T25-120 | 7314150509799 | 1   | 96  |
| 7809TORX-T27     | 7314151811754 | 1   | 95  |
| 7809TORX-T27-120 | 7314150509812 | 1   | 96  |
| 7809TORX-T30     | 7314151811761 | 1   | 95  |
| 7809TORX-T30-120 | 7314150509836 | 1   | 96  |
| 7809TORX-T40     | 7314151811778 | 1   | 95  |
| 7809TORX-T40-120 | 7314150220564 | 1   | 96  |
| 7809TORX-T45     | 7314151811785 | 1   | 95  |
| 7809TORX-T45-120 | 7314150220557 | 1   | 96  |
| 7809TORX-T50     | 7314151811792 | 1   | 95  |
| 7809TORX-T50-100 | 7314150220540 | 1   | 96  |
| 7809TORX-T55     | 7314151811808 | 1   | 95  |
| 7809TORX-T55-120 | 7314150509874 | 1   | 96  |
| 7809TORX-T60     | 7314151811815 | 1   | 95  |
| 7809TORX-T60-120 | 7314150509898 | 1   | 96  |
| 7809TORX-T70     | 7314150509744 | 10  | 95  |
| 7809TORX-T70-140 | 7314150220526 | 5   | 96  |
| 7809TORX/10      | 7314151831455 | 1   | 73  |
| 7809XZN-10       | 7314151831080 | 1   | 97  |
| 7809XZN-10-100   | 7314151831097 | 1   | 97  |
| 7809XZN-12       | 7314151831103 | 1   | 97  |
| 7809XZN-12-100   | 7314151831110 | 1   | 97  |
| 7809XZN-14       | 7314153004574 | 1   | 97  |
| 7809XZN-14-100   | 7314153004567 | 1   | 97  |
| 7809XZN-16       | 7314150220458 | 1   | 97  |
| 7809XZN-18       | 7314150314058 | 1   | 97  |
| 7809XZN-6        | 7314150214617 | 1   | 97  |
| 7809XZN-8        | 7314151831066 | 1   | 97  |
| 7809XZN-8-100    | 7314151831073 | 1   | 97  |
| 7809Z-1/2        | 7314153003515 | 1   | 96  |
| 7809Z-1/4        | 7314153003478 | 1   | 96  |
| 7809Z-17/32      | 7314150313785 | 1   | 96  |
| 7809Z-19/32      | 7314153003546 | 1   | 96  |
| 7809Z-3/16       | 7314153003461 | 1   | 96  |
| 7809Z-3/8        | 7314153003492 | 1   | 96  |
| 7809Z-5/16       | 7314153003485 | 1   | 96  |
| 7809Z-5/8        | 7314153003553 | 1   | 96  |
| 7809Z-7/16       | 7314153003508 | 1   | 96  |
| 7809Z-9/16       | 7314153003539 | 1   | 96  |
| 7809Z/10         | 7314153003560 | 1   | 73  |
| 7810MB           | 7314150220380 | 1   | 76  |
| 7810MH           | 7314150220373 | 1   | 76  |
| 7811DMV          | 7314150122134 | 1   | 504 |
| 7812             | 7314150502028 | 100 | 318 |
| 7814DS           | 7314150318964 | 1   | 73  |
| 7817DZS          | 7314150319008 | 1   | 74  |
| 7817DZS1         | 7314150389902 | 1   | 75  |
| 7818DS           | 7314150318971 | 1   | 73  |
| 7818DST          | 7314150319039 | 1   | 75  |
| 7818MHR          | 7314150218912 | 1   | 73  |
| 7818SST          | 7314150319046 | 1   | 75  |
| 7819DRN          | 7314151831547 | 1   | 74  |
| 782-U            | 7311518276447 | 1   | 308 |
| 7823             | 7314150218141 | 1   | 170 |
| 7823DZS          | 7314150319015 | 1   | 75  |
| 7825DST          | 7314150319060 | 1   | 75  |
| 7825MBP          | 7314150218929 | 1   | 74  |
| 7825MHP          | 7314150218943 | 1   | 74  |
| 7825SST          | 7314150319053 | 1   | 75  |
| 7827DST          | 7314150319077 | 1   | 76  |
| 783              | 7311518276034 | 1   | 326 |
| 7835 G-160       | 7314150050253 | 5   | 245 |
| 7847SS           | 7314150318995 | 1   | 74  |
| 7851-G           | 7314150124909 | 1   | 115 |
| 7851-M           | 7314150124893 | 1   | 115 |
| 7865             | 7311518276720 | 1   | 170 |
| 787-1.1/16       | 7314150363186 | 1   | 51  |
| 787-1.1/2        | 7314150363254 | 1   | 51  |
| 787-1.1/4        | 7314150363216 | 1   | 51  |
| 787-1.1/8        | 7314150363193 | 1   | 51  |
| 787-1.11/16      | 7314150363278 | 1   | 51  |
| 787-1.13/16      | 7314150363292 | 1   | 51  |
| 787-1.3/16       | 7314150363209 | 1   | 51  |
| 787-1.3/4        | 7314150363285 | 1   | 51  |



|               |               |    |     |
|---------------|---------------|----|-----|
| 787-1.3/8     | 7314150363230 | 1  | 51  |
| 787-1.5/16    | 7314150363223 | 1  | 51  |
| 787-1.5/8     | 7314150363261 | 1  | 51  |
| 787-1.7/16    | 7314150363247 | 1  | 51  |
| 787-1.7/8     | 7314150363308 | 1  | 51  |
| 787-2         | 7314150363315 | 1  | 51  |
| 787-2.1/4     | 7314150363346 | 1  | 51  |
| 787-2.1/8     | 7314150363322 | 1  | 51  |
| 787-2.3/16    | 7314150363339 | 1  | 51  |
| 787-2.3/8     | 7314150363353 | 1  | 51  |
| 7888DM        | 7314151820923 | 1  | 74  |
| 789-1.1/2     | 7314150363896 | 1  | 55  |
| 789-1.1/4     | 7314150363858 | 1  | 55  |
| 789-1.1/8     | 7314150363841 | 1  | 55  |
| 789-1.13/16   | 7314150363933 | 1  | 55  |
| 789-1.3/4     | 7314150363926 | 1  | 55  |
| 789-1.3/8     | 7314150363872 | 1  | 55  |
| 789-1.5/16    | 7314150363865 | 1  | 55  |
| 789-1.5/8     | 7314150363919 | 1  | 55  |
| 789-1.7/16    | 7314150363889 | 1  | 55  |
| 789-1.9/16    | 7314150363902 | 1  | 55  |
| 789-2         | 7314150363940 | 1  | 55  |
| 789-2.1/4     | 7314150363957 | 1  | 55  |
| 789-2.3/8     | 7314150363971 | 1  | 55  |
| 789-2.5/16    | 7314150363964 | 1  | 55  |
| 789-28        | 7314150363742 | 1  | 55  |
| 789-30        | 7314150363759 | 1  | 55  |
| 789-32        | 7314150363767 | 1  | 55  |
| 789-34        | 7314150363766 | 1  | 55  |
| 789-36        | 7314150363773 | 1  | 55  |
| 789-38        | 7314150363780 | 1  | 55  |
| 789-40        | 7314150363797 | 1  | 55  |
| 789-41        | 7314150363803 | 1  | 55  |
| 789-42        | 7314150363810 | 1  | 55  |
| 789-46        | 7314150363827 | 1  | 55  |
| 789-50        | 7314150363834 | 1  | 55  |
| 7890          | 7314150052691 | 10 | 651 |
| 7890 CO       | 7314150052899 | 10 | 651 |
| 7891          | 7314150052714 | 10 | 651 |
| 7891 CO       | 7314150052905 | 10 | 651 |
| 7892          | 7314150052738 | 10 | 651 |
| 7892 CO       | 7314150291687 | 10 | 651 |
| 7893          | 7314150052769 | 10 | 652 |
| 7893K         | 7314150351428 | 10 | 652 |
| 7894          | 7314150197484 | 10 | 652 |
| 790450A       | 7314150214716 | 1  | 264 |
| 790455A       | 7314150214709 | 1  | 264 |
| 7992          | 7314150470921 | 5  | 654 |
| 7993M0170     | 8413345115353 | 1  | 182 |
| 7993M0190     | 8413345115377 | 1  | 182 |
| 7993M0220     | 8413345115391 | 1  | 182 |
| 7993M0270     | 8413345115414 | 1  | 182 |
| 7993S0050     | 8413345115070 | 1  | 177 |
| 7993S0060     | 8413345115094 | 1  | 177 |
| 7993S0080     | 8413345115117 | 1  | 177 |
| 7993S0100     | 8413345115131 | 1  | 177 |
| 7993S0120     | 8413345115155 | 1  | 177 |
| 7993S0140     | 8413345115179 | 1  | 177 |
| 7993S0170     | 8413345115193 | 1  | 177 |
| 7993S0180     | 7314150476855 | 1  | 177 |
| 7993S0190     | 8413345115216 | 1  | 177 |
| 7993T0120     | 8413345115230 | 1  | 180 |
| 7993T0140     | 8413345115254 | 1  | 180 |
| 7993T0170     | 8413345115278 | 1  | 180 |
| 7993T0190     | 8413345115292 | 1  | 180 |
| 7993T0220     | 8413345115315 | 1  | 180 |
| 7993T0240     | 8413345115339 | 1  | 180 |
| 7994S0200     | 7314150492954 | 1  | 177 |
| 7994S0250     | 7314150492947 | 1  | 177 |
| 7994S0270     | 7314150492930 | 1  | 177 |
| 7994S0300     | 8413345129305 | 1  | 177 |
| 7994S0400     | 8413345129312 | 1  | 177 |
| 7994S0450     | 8413345129329 | 1  | 177 |
| 7994S0500     | 8413345129336 | 1  | 177 |
| 7994S0550     | 8413345129343 | 1  | 177 |
| 7994S0600     | 8413345129350 | 1  | 177 |
| 7994S0700     | 7314150522583 | 1  | 177 |
| 800-1.5-50ESD | 8412243589327 | 10 | 653 |
| 800-2.50ESD   | 8412243589341 | 10 | 653 |
| 800-2.5-50ESD | 8412243589365 | 10 | 653 |
| 800-3-50ESD   | 8412243589389 | 10 | 653 |
| 801-0-50ESD   | 8412243589426 | 10 | 653 |
| 801-00-50ESD  | 8412243589402 | 10 | 653 |
| 801-1-75ESD   | 8412243589440 | 10 | 653 |
| 801-7ESD      | 8412243589280 | 1  | 653 |
| 8010SL-2P     | 7314150243853 | 1  | 498 |
| 801C          | 7314150402151 | 10 | 652 |
| 8020-2P       | 7314150246601 | 1  | 195 |
| 803-10-50ESD  | 8412243589648 | 10 | 653 |
| 803-15-75ESD  | 8412243589549 | 10 | 653 |
| 803-20-75ESD  | 8412243589563 | 10 | 653 |
| 803-6-50ESD   | 8412243589464 | 10 | 653 |
| 803-7-50ESD   | 8412243589488 | 10 | 653 |
| 803-7ESD      | 8412243589303 | 1  | 653 |
| 803-8-50ESD   | 8412243589501 | 10 | 653 |
| 803-9-50ESD   | 8412243589525 | 10 | 653 |



|               |                |    |     |
|---------------|----------------|----|-----|
| 8030-2P       | 7314150246618  | 1  | 195 |
| 8040-2P       | 7314150246625  | 1  | 195 |
| 8040L-2P      | 7314150246670  | 1  | 196 |
| 8040SL-2P     | 7314150243877  | 1  | 498 |
| 8045LVDE      | 7314151509163  | 10 | 219 |
| 8045VDE       | 73141515137256 | 10 | 219 |
| 805-TS1-50ESD | 8412243589587  | 10 | 653 |
| 805-TS4-50ESD | 8412243589600  | 10 | 653 |
| 805-TS5-50ESD | 8412243589624  | 10 | 653 |
| 8050SL-2P     | 7314150243884  | 1  | 498 |
| 8052          | 7314151318406  | 5  | 218 |
| 806-1-1       | 7311518003760  | 6  | 219 |
| 806-1-2       | 7314150183258  | 6  | 219 |
| 806-1-3       | 7314150183265  | 6  | 219 |
| 8060B0080     | 8413345018104  | 1  | 267 |
| 8060B0100     | 8413345018111  | 1  | 267 |
| 8060B0120     | 8413345018128  | 1  | 267 |
| 8060B0140     | 8413345018135  | 1  | 267 |
| 8060B0180     | 8413345018142  | 1  | 267 |
| 8060B0240     | 8413345018159  | 1  | 267 |
| 8060B0360     | 8413345018166  | 1  | 267 |
| 8060T0080     | 8413345018173  | 1  | 267 |
| 8060T0100     | 8413345018180  | 1  | 267 |
| 8060T0140     | 8413345018203  | 1  | 267 |
| 8060T0180     | 8413345018210  | 1  | 267 |
| 8060T0240     | 8413345018227  | 1  | 267 |
| 8060T0360     | 8413345018234  | 1  | 267 |
| 8069          | 7314150007028  | 5  | 39  |
| 8069 C        | 7314150007035  | 5  | 39  |
| 8069 C IP     | 7314150101634  | 5  | 39  |
| 8069 IP       | 7314150007042  | 50 | 39  |
| 8069-1        | 7314150239511  | 1  | 39  |
| 8069-2        | 7314150238590  | 1  | 39  |
| 8070          | 7314150007110  | 5  | 39  |
| 8070 C        | 7314150007127  | 5  | 39  |
| 8070 C IP     | 7314150101641  | 5  | 39  |
| 8070 IP       | 7314150007134  | 40 | 39  |
| 8070-1        | 7314150239528  | 1  | 39  |
| 8070-2        | 7314150238606  | 1  | 39  |
| 8070V         | 7314150121519  | 2  | 501 |
| 8070VL        | 7314150213511  | 1  | 501 |
| 8071          | 7314150007202  | 5  | 39  |
| 8071 C        | 7314150007219  | 5  | 39  |
| 8071 C IP     | 7314150101658  | 5  | 39  |
| 8071 IP       | 7314150007226  | 50 | 39  |
| 8071-1        | 7314150239535  | 1  | 39  |
| 8071-2        | 7314150238613  | 1  | 39  |
| 8071V         | 7314150121526  | 2  | 501 |
| 8071VL        | 7314150213535  | 1  | 501 |
| 8071VLT       | 7314150121564  | 1  | 501 |
| 8072          | 7314150007288  | 5  | 39  |
| 8072 C        | 7314150007295  | 5  | 39  |
| 8072 C IP     | 7314150101665  | 5  | 39  |
| 8072 IP       | 7314150007301  | 30 | 39  |
| 8072-1        | 7314150239542  | 1  | 39  |
| 8072-2        | 7314150238620  | 1  | 39  |
| 8072V         | 7314150121533  | 2  | 501 |
| 8072VL        | 7314150213542  | 1  | 501 |
| 8072VLT       | 7314150121571  | 1  | 501 |
| 8073          | 7314150007363  | 5  | 39  |
| 8073 C        | 7314150007370  | 5  | 39  |
| 8073 C IP     | 7314150101672  | 5  | 39  |
| 8073 IP       | 7314150007387  | 20 | 39  |
| 8073-1        | 7314150239559  | 1  | 39  |
| 8073-2        | 7314150238637  | 1  | 39  |
| 8073V         | 7314150121540  | 2  | 501 |
| 8073VL        | 7314150213559  | 1  | 501 |
| 8073VLT       | 7314150121588  | 1  | 501 |
| 8074          | 7314150007448  | 3  | 39  |
| 8074 C        | 7314150007455  | 3  | 39  |
| 8074 C IP     | 7314150101689  | 3  | 39  |
| 8074 IP       | 7314150007462  | 20 | 39  |
| 8074-1        | 7314150239566  | 1  | 39  |
| 8074-2        | 7314150238644  | 1  | 39  |
| 8074V         | 7314150121557  | 2  | 501 |
| 8075          | 7314150007523  | 3  | 39  |
| 8075 C        | 7314150007530  | 3  | 39  |
| 8075 C IP     | 7314150101696  | 3  | 39  |
| 8075 IP       | 7314150007547  | 10 | 39  |
| 8075-1        | 7314150239573  | 1  | 39  |
| 8075-2        | 7314150238651  | 1  | 39  |
| 808050        | 7314153017642  | 50 | 211 |
| 808050A       | 7314150127306  | 1  | 217 |
| 808050L       | 7314150128075  | 25 | 211 |
| 808050L-SP1   | 7314150129218  | 1  | 211 |
| 808050P       | 7314150128105  | 50 | 211 |
| 808050P-25    | 7314150165179  | 10 | 211 |
| 808050S       | 7314150128082  | 25 | 212 |
| 808050S-18    | 7314150128921  | 30 | 212 |
| 808050S-22    | 7314150128938  | 30 | 212 |
| 808050TORX    | 7314150127313  | 50 | 217 |
| 808050TS      | 7314150128099  | 1  | 211 |
| 808060        | 7314150243822  | 1  | 498 |
| 808061        | 7314150243839  | 5  | 498 |
| 808062        | 7314150243846  | 5  | 498 |
| 8100B0140     | 7314150263028  | 1  | 267 |



|                     |                |    |     |
|---------------------|----------------|----|-----|
| 8100B0180           | 7314150263042  | 1  | 267 |
| 8100B0240           | 8413345018296  | 1  | 267 |
| 8100B0360           | 84133450099660 | 1  | 267 |
| 8100F0180           | 7314150263059  | 1  | 267 |
| 8100F0240           | 7314150263066  | 1  | 267 |
| 8100T0100           | 7314150263073  | 1  | 267 |
| 8100T0140           | 8413345018333  | 1  | 267 |
| 8100T0180           | 7314150263080  | 1  | 267 |
| 8100T0240           | 7314150263097  | 1  | 267 |
| 8100T0360           | 7314150263103  | 1  | 267 |
| 8100T0480           | 7314150263127  | 1  | 267 |
| 8110H-1/2           | 7314153015860  | 1  | 97  |
| 8120-1/2            | 7314150384884  | 12 | 97  |
| 8120-1/4            | 7314150384921  | 20 | 84  |
| 8120-3/8            | 7314150384914  | 10 | 89  |
| 813                 | 7314150055852  | 1  | 649 |
| 8130                | 7314150050918  | 10 | 644 |
| 8130-50/SUPR SPRING | 7314150111572  | 1  | 649 |
| 8131                | 7314150050925  | 10 | 644 |
| 8131 CO             | 7314150051519  | 10 | 644 |
| 8132                | 7314150050932  | 10 | 644 |
| 8133                | 7314150470945  | 10 | 644 |
| 8134                | 7314150470952  | 10 | 644 |
| 8135                | 7314150470969  | 10 | 644 |
| 8136                | 7314150470976  | 10 | 645 |
| 8137                | 7314150459728  | 10 | 645 |
| 8138                | 7314150361540  | 10 | 645 |
| 814                 | 7314150055845  | 1  | 649 |
| 8140                | 7314150050949  | 10 | 644 |
| 8140 CO             | 7314150051533  | 10 | 644 |
| 8140M2              | 7314150470983  | 10 | 649 |
| 8140PS              | 7314150358472  | 10 | 649 |
| 8141                | 7314150050987  | 10 | 644 |
| 8141 CO             | 7314150051557  | 10 | 644 |
| 8141PS              | 7314150349425  | 10 | 649 |
| 8142                | 7314150051007  | 10 | 644 |
| 8142 CO             | 7314150051564  | 10 | 644 |
| 8143                | 7314150051021  | 10 | 644 |
| 8144                | 7314150051045  | 10 | 644 |
| 8144 CO             | 7314150051601  | 10 | 644 |
| 8145                | 7314150051052  | 10 | 644 |
| 8146                | 7314150051076  | 10 | 645 |
| 8147                | 7314150051083  | 10 | 645 |
| 8148                | 7314150051090  | 10 | 645 |
| 8148 CO             | 7314150051656  | 10 | 645 |
| 8149                | 7314150051106  | 10 | 648 |
| 8150                | 7314150051113  | 10 | 644 |
| 8150 CO             | 7314150051670  | 10 | 644 |
| 8150 J              | 7314150051137  | 10 | 654 |
| 8150 SK             | 7314150112814  | 10 | 654 |
| 8150-1/2            | 7314151105006  | 1  | 97  |
| 8150-1/2-SPARE      | 7314150187881  | 1  | 98  |
| 8150-1/2V           | 7314150121601  | 1  | 502 |
| 8150M2              | 7314150470990  | 10 | 649 |
| 8150PS              | 7314150358489  | 10 | 649 |
| 8150RN-1/2          | 7314151831202  | 1  | 97  |
| 8150RN-1/2-SPARE    | 7314150209378  | 1  | 98  |
| 8150SL              | 7314150197682  | 1  | 97  |
| 8150SL-SPARE        | 7314150210275  | 1  | 98  |
| 8151                | 7314150051199  | 10 | 644 |
| 8151 CO             | 7314150051694  | 10 | 644 |
| 8151-1/2            | 7314151105112  | 1  | 98  |
| 8152                | 7314150052097  | 10 | 644 |
| 8152-1/2            | 7314151105129  | 1  | 93  |
| 8153                | 7314150051205  | 10 | 644 |
| 8154                | 7314150052103  | 10 | 644 |
| 8154 CO             | 7314150052233  | 10 | 644 |
| 8154-1/2V           | 7314150121595  | 1  | 502 |
| 8154-11             | 7314150469161  | 10 | 93  |
| 8154PSP             | 7314150347704  | 10 | 650 |
| 8155                | 7314150052110  | 10 | 644 |
| 8156                | 7314150051212  | 10 | 645 |
| 8157                | 7314150052127  | 10 | 645 |
| 8157-10             | 7314150467273  | 1  | 93  |
| 8157-15             | 7314150469222  | 1  | 93  |
| 8157-24             | 7314150469246  | 1  | 93  |
| 8157-36             | 7314150469260  | 10 | 93  |
| 8158                | 7314150052134  | 10 | 645 |
| 8158-10             | 7314150471003  | 1  | 93  |
| 8158-15             | 7314150471010  | 1  | 93  |
| 816                 | 7314150428182  | 1  | 649 |
| 8160                | 7314150051229  | 10 | 644 |
| 8160 CO             | 7314150051724  | 10 | 644 |
| 8160 J              | 7314150051250  | 10 | 654 |
| 8160 M2             | 7314150381906  | 10 | 649 |
| 8160-1/2V           | 7314150121618  | 1  | 502 |
| 8160-10             | 7314150469185  | 10 | 93  |
| 8160-3              | 7314150469208  | 10 | 93  |
| 8160-5              | 7314150469284  | 10 | 93  |
| 8160-B              | 7314150182565  | 1  | 94  |
| 8160/SPRING         | 7314150229888  | 1  | 649 |
| 8160PS              | 7314150358496  | 10 | 649 |
| 8160W-10            | 7314150471027  | 10 | 94  |
| 8160W-3             | 7314150471041  | 10 | 94  |
| 8160W-5             | 7314150471065  | 10 | 94  |
| 8161                | 7314150051328  | 10 | 644 |





|                  |               |    |     |
|------------------|---------------|----|-----|
| 8161 CO          | 7314150051748 | 10 | 644 |
| 8161PS           | 7314150361533 | 10 | 649 |
| 8162             | 7314150051335 | 10 | 644 |
| 8162-1/2V        | 7314150121625 | 1  | 502 |
| 8163             | 7314150051342 | 10 | 644 |
| 8163 CO          | 7314150051762 | 10 | 644 |
| 8164             | 7314150052141 | 10 | 644 |
| 8164-1/2         | 7314151105266 | 1  | 88  |
| 8165             | 7314150052158 | 10 | 644 |
| 8165 CO          | 7314150052288 | 10 | 644 |
| 8166             | 7314150459377 | 10 | 94  |
| 8166L            | 7314150476350 | 10 | 645 |
| 8167             | 7314153003584 | 1  | 88  |
| 8167L            | 7314150476367 | 10 | 645 |
| 8168             | 7314150128440 | 1  | 94  |
| 8168L            | 7314150347711 | 10 | 645 |
| 8171             | 7314150469307 | 10 | 94  |
| 8172             | 7314150469321 | 10 | 94  |
| 8174A            | 7314150476374 | 10 | 94  |
| 8178             | 7314150512065 | 10 | 93  |
| 8194-1/2         | 7314151831226 | 1  | 98  |
| 8195-KEY         | 7314150389810 | 50 | 94  |
| 8195-R           | 7314150389780 | 1  | 97  |
| 8195-SET         | 7314150389797 | 5  | 97  |
| 8195-SQ          | 7314150389803 | 25 | 98  |
| 8211             | 7314150101030 | 10 | 646 |
| 8220SL-2P        | 7314150243860 | 1  | 498 |
| 8223             | 7314150112685 | 4  | 247 |
| 8223 IP          | 7314150113149 | 4  | 247 |
| 8224             | 7314150000012 | 4  | 247 |
| 8224 IP          | 7314150101757 | 4  | 247 |
| 8224CIP          | 7314150103607 | 4  | 247 |
| 8225             | 7314150000029 | 4  | 247 |
| 8225 IP          | 7314150101764 | 4  | 247 |
| 8225CIP          | 7314150103614 | 4  | 247 |
| 8226             | 7314150115853 | 1  | 247 |
| 8231             | 7311518266509 | 4  | 247 |
| 8231 IP          | 7311518270285 | 4  | 247 |
| 8242-2P          | 7314150243686 | 1  | 195 |
| 8242L-2P         | 7314150246687 | 1  | 196 |
| 8247             | 7314150051397 | 10 | 646 |
| 8247 CO          | 7314150051809 | 10 | 646 |
| 8248             | 7314150051427 | 10 | 647 |
| 8248 CO          | 7314150051823 | 10 | 647 |
| 8248Q            | 7314150349364 | 10 | 648 |
| 8249             | 7314150349401 | 10 | 647 |
| 8252-2P          | 7314150243693 | 1  | 195 |
| 8252L-2P         | 7314150246694 | 1  | 196 |
| 8252XL-1P        | 7314150265985 | 1  | 197 |
| 833AJ-4          | 7311518286927 | 1  | 590 |
| 833AJ-5          | 7311518286934 | 1  | 590 |
| 833AJ-6          | 7311518286941 | 1  | 590 |
| 833FJ-4          | 7311518286965 | 1  | 590 |
| 833FJ-5          | 7311518286972 | 1  | 590 |
| 833FJ-6          | 7311518286989 | 1  | 590 |
| 833PJ-4          | 7311518286897 | 1  | 589 |
| 833PJ-5          | 7311518286903 | 1  | 589 |
| 833PJ-67         | 7311518286910 | 1  | 589 |
| 833SB-4          | 7311518286859 | 1  | 590 |
| 833SB-5          | 7311518286866 | 1  | 590 |
| 833SB-6          | 7311518286873 | 1  | 590 |
| 833SB-7          | 7311518286880 | 1  | 590 |
| 834V-2           | 7314150124992 | 1  | 589 |
| 834V-4           | 7311518286811 | 1  | 589 |
| 834V-5           | 7311518286828 | 1  | 589 |
| 834V-6           | 7311518286835 | 1  | 589 |
| 834V-7           | 7311518286842 | 1  | 589 |
| 84-PODGER        | 7314150307494 | 1  | 40  |
| 850-1            | 7311518292737 | 10 | 548 |
| 8501-10          | 7311518004828 | 1  | 141 |
| 8501-10F         | 7311518220945 | 1  | 141 |
| 8501-12          | 7311518004842 | 1  | 141 |
| 8501-12F         | 7311518220952 | 1  | 141 |
| 8501-13          | 7311518004859 | 1  | 141 |
| 8501-136-10-24C  | 7314150371471 | 1  | 141 |
| 8501-136-20-24C  | 7314150371488 | 1  | 141 |
| 8501-13F         | 7311518220969 | 1  | 141 |
| 8501-15          | 7311518004873 | 1  | 141 |
| 8501-150-10-24C  | 7314150403004 | 1  | 141 |
| 8501-15F         | 7311518220976 | 1  | 141 |
| 8501-16          | 7311518004880 | 1  | 141 |
| 8501-160-20-24C  | 7314150403011 | 1  | 141 |
| 8501-160-20-48XF | 7314150402892 | 1  | 141 |
| 8501-165-20-24C  | 7314150403028 | 1  | 141 |
| 8501-165-20-48XF | 7314150402908 | 1  | 141 |
| 8501-16F         | 7311518220983 | 1  | 141 |
| 8501-16SW        | 7314150258642 | 1  | 141 |
| 8501-17          | 7311518004897 | 1  | 141 |
| 8501-17F         | 7311518220990 | 1  | 141 |
| 8501-17S         | 7311518221027 | 1  | 142 |
| 8501-184-16-24   | 7314150402946 | 1  | 141 |
| 8501-184-16-40   | 7314150402953 | 1  | 141 |
| 8501-184-20-24C  | 7314150403042 | 1  | 141 |
| 8501-18S         | 7311518221034 | 1  | 142 |
| 8501-18SW        | 7311518221058 | 1  | 141 |
| 8501-190-30-24C  | 7314150403059 | 1  | 141 |



|                  |               |    |     |
|------------------|---------------|----|-----|
| 8501-190-30-60XF | 7314150402960 | 1  | 141 |
| 8501-2           | 7311518004743 | 1  | 141 |
| 8501-210-30-48SW | 7314150403066 | 1  | 141 |
| 8501-210-30-60XF | 7314150402977 | 1  | 141 |
| 8501-216-60SW    | 7314150359448 | 1  | 141 |
| 8501-22          | 7311518178888 | 1  | 141 |
| 8501-22F         | 7311518221003 | 1  | 141 |
| 8501-23          | 7311518004958 | 1  | 141 |
| 8501-230-30-60XF | 7314150402984 | 1  | 141 |
| 8501-235-30-60XF | 7314150402991 | 1  | 141 |
| 8501-23F         | 7311518018887 | 1  | 141 |
| 8501-260-24SW    | 7314150359479 | 1  | 141 |
| 8501-260-30-80S  | 7314150403097 | 1  | 142 |
| 8501-260-40SW    | 7314150359462 | 1  | 141 |
| 8501-260-60SW    | 7314150359455 | 1  | 141 |
| 8501-28          | 7311518018894 | 1  | 141 |
| 8501-28F         | 7311518221010 | 1  | 141 |
| 8501-28S         | 7311518221041 | 1  | 142 |
| 8501-28SW        | 7311518221065 | 1  | 141 |
| 8501-28XF        | 7311518281946 | 1  | 141 |
| 8501-3           | 7311518004750 | 1  | 141 |
| 8501-30          | 7311518237479 | 1  | 141 |
| 8501-305-30-40SW | 7314150403073 | 1  | 141 |
| 8501-305-30-60SW | 7314150403080 | 1  | 141 |
| 8501-305-30-96S  | 7314150403103 | 1  | 142 |
| 8501-30F         | 7311518237462 | 1  | 141 |
| 8501-30S         | 7311518282240 | 1  | 142 |
| 8501-30SW        | 7311518282196 | 1  | 141 |
| 8501-30XF        | 7311518281984 | 1  | 141 |
| 8501-31          | 7311518237455 | 1  | 141 |
| 8501-31F         | 7311518237448 | 1  | 141 |
| 8501-4           | 7311518008079 | 1  | 141 |
| 8501-40          | 7311518282042 | 1  | 141 |
| 8501-4F          | 7311518220914 | 1  | 141 |
| 8501-4XF         | 7311518281786 | 1  | 141 |
| 8501-5           | 7311518004774 | 1  | 141 |
| 8501-5F          | 7311518220921 | 1  | 141 |
| 8501-7           | 7311518004798 | 1  | 141 |
| 8501-7F          | 7311518220938 | 1  | 141 |
| 8510SL-2P        | 7314150245758 | 1  | 498 |
| 8520SL-2P        | 7314150245765 | 1  | 498 |
| 86               | 7314150005376 | 1  | 39  |
| 86-1             | 7314150254996 | 1  | 39  |
| 86-2             | 7314150255009 | 1  | 39  |
| 8600-2P          | 7314150246564 | 1  | 195 |
| 8610-2P          | 7314150243648 | 1  | 195 |
| 8610L-2P         | 7314150246700 | 1  | 196 |
| 8610SL-2P        | 7314150243891 | 1  | 498 |
| 8620-2P          | 7314150243662 | 1  | 195 |
| 8620L-2P         | 7314150246717 | 1  | 196 |
| 8620SL-2P        | 7314150243907 | 1  | 498 |
| 8620XL-1P        | 7314150265947 | 1  | 197 |
| 8630-2P          | 7314150246571 | 1  | 195 |
| 8630XL-1P        | 7314150265961 | 1  | 197 |
| 864000010        | 8413345137638 | 1  | 553 |
| 864000020        | 7314150330171 | 1  | 553 |
| 864002450        | 8413345129022 | 50 | 553 |
| 864100010        | 8413345137621 | 1  | 553 |
| 864102400        | 8413345129015 | 1  | 553 |
| 865-1            | 7311518292744 | 10 | 548 |
| 869102500        | 8413345083669 | 6  | 578 |
| 869103000        | 8413345116640 | 6  | 578 |
| 869203000        | 8413345137508 | 6  | 578 |
| 87               | 7314150005406 | 3  | 39  |
| 87-1             | 7314150255016 | 1  | 39  |
| 87-2             | 7314150255023 | 1  | 39  |
| 8703-2P          | 7314150246632 | 1  | 196 |
| 8704-2P          | 7314150246649 | 1  | 196 |
| 8705-2P          | 7314150246656 | 1  | 196 |
| 8706-2P          | 7314150246663 | 1  | 196 |
| 8710SL-2P        | 7314150245772 | 1  | 498 |
| 8720SL-2P        | 7314150245789 | 1  | 498 |
| 874002000        | 8413345024938 | 5  | 605 |
| 874002500        | 8413345024945 | 5  | 605 |
| 874003000        | 8413345024952 | 5  | 605 |
| 874003500        | 8413345024969 | 5  | 605 |
| 874004000        | 8413345024976 | 5  | 605 |
| 874005000        | 8413345024983 | 5  | 605 |
| 874102000        | 8413345080989 | 6  | 605 |
| 874102500        | 8413345081009 | 5  | 605 |
| 874103000        | 8413345081023 | 5  | 605 |
| 874103500        | 8413345081047 | 4  | 605 |
| 874104000        | 8413345081061 | 5  | 605 |
| 874602000        | 8413345024990 | 5  | 605 |
| 874602500        | 8413345025003 | 5  | 605 |
| 874603000        | 8413345025065 | 5  | 605 |
| 874603500        | 8413345025072 | 5  | 605 |
| 874604000        | 8413345025089 | 5  | 605 |
| 874916X16        | 7314150489787 | 1  | 606 |
| 874918X18        | 7314150489800 | 1  | 606 |
| 874923X13        | 7314150489763 | 1  | 606 |
| 874926X7         | 7314150489749 | 1  | 606 |
| 876002000        | 8413345025119 | 10 | 606 |
| 876002500        | 8413345025126 | 5  | 606 |
| 877002400        | 8413345025140 | 25 | 606 |
| 8800-2P          | 7314150246588 | 1  | 195 |





|                |               |   |     |
|----------------|---------------|---|-----|
| 8810-2P        | 7314150243655 | 1 | 195 |
| 8810L-2P       | 7314150246724 | 1 | 196 |
| 8810SL-2P      | 7314150243914 | 1 | 498 |
| 8820-2P        | 7314150243679 | 1 | 195 |
| 8820L-2P       | 7314150246731 | 1 | 196 |
| 8820SL-2P      | 7314150243921 | 1 | 498 |
| 8820XL-1P      | 7314150265954 | 1 | 197 |
| 8821MB         | 7314150220571 | 1 | 77  |
| 8830-2P        | 7314150246595 | 1 | 195 |
| 8830XL-1P      | 7314150265978 | 1 | 197 |
| 8840M          | 7314151105495 | 1 | 77  |
| 8845DM         | 7314151105525 | 1 | 77  |
| 8845NM         | 7314151810955 | 1 | 77  |
| 8900DM-19      | 7314151105730 | 1 | 99  |
| 8900DM-21      | 7314150166367 | 5 | 99  |
| 8900DM-22      | 7314151105754 | 1 | 99  |
| 8900DM-23      | 7314150166374 | 1 | 99  |
| 8900DM-24      | 7314151105778 | 1 | 99  |
| 8900DM-25      | 7314151105785 | 1 | 99  |
| 8900DM-26      | 7314150219797 | 1 | 99  |
| 8900DM-27      | 7314151105822 | 1 | 99  |
| 8900DM-28      | 7314151105846 | 1 | 99  |
| 8900DM-29      | 7314150219803 | 1 | 99  |
| 8900DM-30      | 7314151105884 | 5 | 99  |
| 8900DM-32      | 7314151105891 | 1 | 99  |
| 8900DM-33      | 7314150166398 | 1 | 99  |
| 8900DM-34      | 7314151838478 | 1 | 99  |
| 8900DM-35      | 7314150219810 | 1 | 99  |
| 8900DM-36      | 7314151105914 | 1 | 99  |
| 8900DM-37      | 7314150166404 | 1 | 99  |
| 8900DM-38      | 7314150219827 | 1 | 99  |
| 8900DM-40      | 7314150166411 | 1 | 99  |
| 8900DM-41      | 7314151105938 | 5 | 99  |
| 8900DM-42      | 7314150166428 | 1 | 99  |
| 8900DM-46      | 7314151105952 | 1 | 99  |
| 8900DM-47      | 7314150166435 | 1 | 99  |
| 8900DM-50      | 7314151105969 | 5 | 99  |
| 8900DM-52      | 7314150166442 | 1 | 99  |
| 8900DM-54      | 7314150166459 | 3 | 99  |
| 8900DM-55      | 7314151105983 | 1 | 99  |
| 8900DM-56      | 7314150166466 | 1 | 99  |
| 8900DM-60      | 7314151106003 | 5 | 99  |
| 8900DZ-1       | 7314151106058 | 1 | 99  |
| 8900DZ-1.1/16  | 7314151106065 | 1 | 99  |
| 8900DZ-1.1/2   | 7314151106133 | 1 | 99  |
| 8900DZ-1.1/4   | 7314151106096 | 1 | 99  |
| 8900DZ-1.1/8   | 7314151106072 | 1 | 99  |
| 8900DZ-1.11/16 | 7314150166282 | 1 | 99  |
| 8900DZ-1.13/16 | 7314151106188 | 1 | 99  |
| 8900DZ-1.3/4   | 7314151106171 | 1 | 99  |
| 8900DZ-1.3/8   | 7314151106119 | 1 | 99  |
| 8900DZ-1.5/16  | 7314151106102 | 5 | 99  |
| 8900DZ-1.5/8   | 7314151106157 | 1 | 99  |
| 8900DZ-1.7/8   | 7314151106195 | 1 | 99  |
| 8900DZ-1.9/16  | 7314150166299 | 1 | 99  |
| 8900DZ-13/16   | 7314150166305 | 1 | 99  |
| 8900DZ-15/16   | 7314151106034 | 1 | 99  |
| 8900DZ-2       | 7314151106201 | 1 | 99  |
| 8900DZ-2.1/16  | 7314150166312 | 1 | 99  |
| 8900DZ-2.1/4   | 7314150166329 | 1 | 99  |
| 8900DZ-2.1/8   | 7314150166336 | 1 | 99  |
| 8900DZ-2.3/16  | 7314150358670 | 1 | 99  |
| 8900DZ-2.3/8   | 7314150166350 | 1 | 99  |
| 8900DZ-3/4     | 7314150166381 | 1 | 99  |
| 8900DZ-31/32   | 7314150358663 | 1 | 99  |
| 8900DZ-7/8     | 7314150166473 | 1 | 99  |
| 8900SM-19      | 7314150166633 | 1 | 98  |
| 8900SM-22      | 7314151810795 | 1 | 98  |
| 8900SM-23      | 7314150219834 | 1 | 98  |
| 8900SM-24      | 7314151810801 | 5 | 98  |
| 8900SM-26      | 7314150219841 | 1 | 98  |
| 8900SM-27      | 7314151810818 | 5 | 98  |
| 8900SM-28      | 7314150166657 | 1 | 98  |
| 8900SM-29      | 7314150219858 | 1 | 98  |
| 8900SM-30      | 7314151810825 | 5 | 98  |
| 8900SM-32      | 7314151810832 | 5 | 98  |
| 8900SM-33      | 7314150166671 | 1 | 98  |
| 8900SM-34      | 7314151838461 | 1 | 98  |
| 8900SM-35      | 7314150166688 | 1 | 98  |
| 8900SM-36      | 7314151810849 | 5 | 98  |
| 8900SM-38      | 7314151810856 | 1 | 98  |
| 8900SM-41      | 7314151810863 | 5 | 98  |
| 8900SM-42      | 7314150219865 | 1 | 98  |
| 8900SM-46      | 7314151810870 | 1 | 98  |
| 8900SM-50      | 7314151810887 | 1 | 98  |
| 8900SM-55      | 7314151810894 | 1 | 98  |
| 8900SM-60      | 7314151810900 | 1 | 98  |
| 8900SZ-1       | 7314150166648 | 1 | 98  |
| 8900SZ-1.7/16  | 7314150166589 | 1 | 98  |
| 8900SZ-1.7/8   | 7314150166596 | 1 | 98  |
| 8900SZ-1.9/16  | 7314150166602 | 1 | 98  |
| 8900SZ-13/16   | 7314150166619 | 1 | 98  |
| 8900SZ-2       | 7314150166640 | 1 | 98  |
| 8900SZ-3/4     | 7314150166664 | 1 | 98  |
| 89049TM-1000   | 7314150415403 | 1 | 113 |
| 8905-TM        | 7314150125470 | 1 | 114 |



|              |               |    |     |
|--------------|---------------|----|-----|
| 8910-2P      | 7314150243709 | 1  | 196 |
| 8910SL-2P    | 7314150243938 | 1  | 498 |
| 8915-2P      | 7314150243716 | 1  | 196 |
| 8915L-2P     | 7314150258765 | 1  | 196 |
| 8915SL-2P    | 7314150243945 | 1  | 498 |
| 8920-2P      | 7314150243723 | 1  | 196 |
| 8920L-2P     | 7314150258772 | 1  | 196 |
| 8920SL-2P    | 7314150243952 | 1  | 498 |
| 89222CR-1000 | 7314150415441 | 1  | 114 |
| 8925-2P      | 7314150243730 | 1  | 196 |
| 8925L-2P     | 7314150258789 | 1  | 196 |
| 8925SL-2P    | 7314150243969 | 1  | 498 |
| 8927-2P      | 7314150243747 | 1  | 196 |
| 8927L-2P     | 7314150263516 | 1  | 196 |
| 8930-2P      | 7314150243754 | 1  | 196 |
| 8930L-2P     | 7314150258796 | 1  | 196 |
| 8930SL-2P    | 7314150243976 | 1  | 498 |
| 8940-2P      | 7314150243761 | 1  | 196 |
| 894M-10      | 7314151833039 | 10 | 51  |
| 894M-100     | 7314151833305 | 1  | 51  |
| 894M-105     | 7314151833312 | 1  | 51  |
| 894M-11      | 7314151833046 | 1  | 51  |
| 894M-110     | 7314151833329 | 1  | 51  |
| 894M-115     | 7314151833336 | 1  | 51  |
| 894M-12      | 7314151833053 | 10 | 51  |
| 894M-120     | 7314151833343 | 1  | 51  |
| 894M-125     | 7314150132478 | 1  | 51  |
| 894M-13      | 7314151833060 | 10 | 51  |
| 894M-130     | 7314150132485 | 1  | 51  |
| 894M-135     | 7314150132492 | 1  | 51  |
| 894M-14      | 7314151833077 | 10 | 51  |
| 894M-15      | 7314151833084 | 10 | 51  |
| 894M-16      | 7314150139569 | 10 | 51  |
| 894M-17      | 7314151833091 | 10 | 51  |
| 894M-19      | 7314151833107 | 10 | 51  |
| 894M-21      | 7314150223220 | 5  | 51  |
| 894M-22      | 7314151833114 | 5  | 51  |
| 894M-24      | 7314151833121 | 5  | 51  |
| 894M-27      | 7314151833138 | 5  | 51  |
| 894M-30      | 7314151833145 | 5  | 51  |
| 894M-32      | 7314151833152 | 5  | 51  |
| 894M-34      | 7314150139583 | 1  | 51  |
| 894M-36      | 7314151833169 | 5  | 51  |
| 894M-38      | 7314151833176 | 1  | 51  |
| 894M-41      | 7314151833183 | 1  | 51  |
| 894M-46      | 7314151833190 | 1  | 51  |
| 894M-50      | 7314151833206 | 1  | 51  |
| 894M-55      | 7314151833213 | 1  | 51  |
| 894M-60      | 7314151833220 | 1  | 51  |
| 894M-65      | 7314151833237 | 1  | 51  |
| 894M-7       | 7314151833008 | 10 | 51  |
| 894M-70      | 7314151833244 | 1  | 51  |
| 894M-75      | 7314151833251 | 1  | 51  |
| 894M-8       | 7314151833015 | 10 | 51  |
| 894M-80      | 7314151833268 | 1  | 51  |
| 894M-85      | 7314151833275 | 1  | 51  |
| 894M-9       | 7314151833022 | 10 | 51  |
| 894M-90      | 7314151833282 | 1  | 51  |
| 894M-95      | 7314151833299 | 1  | 51  |
| 8950NA-SO/2  | 7314151816605 | 1  | 101 |
| 8950RN       | 7314150522675 | 1  | 100 |
| 8950RN/A     | 7314150521258 | 1  | 100 |
| 8951         | 7314151106782 | 1  | 101 |
| 8951-M       | 7314150124916 | 1  | 115 |
| 8952N/B      | 7314150180219 | 1  | 99  |
| 8953E-32     | 7314150509447 | 1  | 99  |
| 8954-15      | 7314150522774 | 1  | 99  |
| 8954A        | 7314151106812 | 1  | 99  |
| 8955N        | 7314150434114 | 1  | 100 |
| 8955N-SPARE  | 7314150434121 | 1  | 101 |
| 8955N/A      | 7314150434053 | 1  | 100 |
| 8955N/B      | 7314150434176 | 5  | 100 |
| 8957-19      | 7314150522781 | 1  | 99  |
| 8957A        | 7314150510580 | 1  | 99  |
| 8958A        | 7314151106836 | 1  | 99  |
| 895M-10-11   | 7314151832742 | 10 | 49  |
| 895M-10-13   | 7314151832759 | 10 | 49  |
| 895M-13-17   | 7314151832803 | 10 | 49  |
| 895M-17-19   | 7314151832827 | 10 | 49  |
| 895M-19-22   | 7314151832834 | 10 | 49  |
| 895M-19-24   | 7314151832841 | 5  | 49  |
| 895M-22-24   | 7314151832858 | 5  | 49  |
| 895M-24-27   | 7314151832865 | 5  | 49  |
| 895M-24-30   | 7314151832872 | 5  | 49  |
| 895M-27-32   | 7314151832889 | 5  | 49  |
| 895M-30-32   | 7314151832896 | 5  | 49  |
| 895M-30-36   | 7314151832902 | 1  | 49  |
| 895M-32-36   | 7314151832919 | 1  | 49  |
| 895M-36-41   | 7314151832926 | 1  | 49  |
| 895M-41-46   | 7314151832933 | 1  | 49  |
| 895M-46-50   | 7314151832940 | 1  | 49  |
| 895M-50-55   | 7314151832957 | 1  | 49  |
| 895M-55-60   | 7314151832964 | 1  | 49  |
| 895M-6-7     | 7314151832711 | 1  | 49  |
| 895M-65-70   | 7314151832971 | 10 | 49  |
| 895M-8-10    | 7314151832735 | 10 | 49  |





|                 |               |    |     |
|-----------------|---------------|----|-----|
| 895M-8-9        | 7314151832728 | 10 | 49  |
| 8960-16         | 7314150492855 | 12 | 100 |
| 8960-8          | 7314150492862 | 1  | 100 |
| 8963            | 7314150181087 | 1  | 99  |
| 8966            | 7314151106898 | 1  | 100 |
| 8967            | 7314153003591 | 1  | 94  |
| 8967/S3         | 7314153003607 | 1  | 82  |
| 8971            | 7314150492879 | 1  | 100 |
| 8972            | 7314150492886 | 1  | 100 |
| 9-12-51/3806-KP | 7311518044558 | 5  | 634 |
| 9-462-14-0-0    | 7311518020873 | 5  | 35  |
| 9-467-00-0-0    | 7311518020897 | 1  | 35  |
| 9-469-00-0-0    | 7311518020903 | 1  | 35  |
| 9-484-3.2-10    | 7311518193348 | 10 | 35  |
| 9-484-3.2-1P    | 7311518193522 | 10 | 35  |
| 9-484-5.2-10    | 7311518193355 | 10 | 35  |
| 9-484-5.2-1P    | 7311518193331 | 10 | 35  |
| 9-485-04-10     | 7314150271672 | 10 | 36  |
| 9-485-04-1P     | 7314150271665 | 10 | 36  |
| 9-485-05-10     | 7314150271696 | 10 | 36  |
| 9-485-05-1P     | 7314150271689 | 10 | 36  |
| 9-485-06-10     | 7311518193508 | 10 | 36  |
| 9-485-06-1P     | 7311518193492 | 20 | 36  |
| 9-485-09-10     | 7311518193386 | 10 | 36  |
| 9-485-09-1P     | 7311518193362 | 20 | 36  |
| 9-485-13-10     | 7311518193393 | 10 | 36  |
| 9-485-13-1P     | 7311518193379 | 1  | 36  |
| 9-486-04-10     | 7311518193430 | 10 | 36  |
| 9-486-04-1P     | 7311518193409 | 20 | 36  |
| 9-486-05-10     | 7311518193461 | 10 | 36  |
| 9-486-05-1P     | 7311518193447 | 20 | 36  |
| 9-486-07-10     | 7311518249373 | 10 | 36  |
| 9-486-07-1P     | 7311518249359 | 20 | 36  |
| 9-486-08-10     | 7311518270933 | 10 | 36  |
| 9-486-C-10      | 7311518209599 | 10 | 36  |
| 9-486-C-1P      | 7311518209605 | 10 | 36  |
| 9-488-02-10     | 7311518194772 | 10 | 35  |
| 900T-020-100    | 7314153018106 | 5  | 216 |
| 900T-025-100    | 7314153018113 | 5  | 216 |
| 900T-030-100    | 7314153018120 | 5  | 216 |
| 900T-040-150    | 7314153018137 | 5  | 216 |
| 900T-050-150    | 7314153018144 | 5  | 216 |
| 900T-060-200    | 7314153018151 | 5  | 216 |
| 900T-080-200    | 7314153018168 | 5  | 216 |
| 900T-100-200    | 7314153018175 | 5  | 216 |
| 901T-006-100    | 7314153018182 | 5  | 216 |
| 901T-007-100    | 7314153018199 | 5  | 216 |
| 901T-008-100    | 7314153018205 | 5  | 216 |
| 901T-009-100    | 7314153018212 | 5  | 216 |
| 901T-010-100    | 7314153018229 | 5  | 216 |
| 901T-015-150    | 7314153018236 | 5  | 216 |
| 901T-020-150    | 7314153018243 | 5  | 216 |
| 901T-025-150    | 7314153018250 | 5  | 216 |
| 901T-027-150    | 7314153018267 | 5  | 216 |
| 901T-030-200    | 7314153018274 | 5  | 216 |
| 901T-040-200    | 7314153018281 | 5  | 216 |
| 901T-045-200    | 7314153018298 | 5  | 216 |
| 901T-050-200    | 7314153018304 | 5  | 216 |
| 9029            | 7314153010612 | 5  | 38  |
| 9029 C          | 7314153010629 | 5  | 38  |
| 9029-1          | 7314150239580 | 1  | 39  |
| 9029-2          | 7314150238668 | 1  | 39  |
| 9029-T          | 7314150189076 | 5  | 38  |
| 9029T-1         | 7314150312139 | 1  | 39  |
| 902T-050-150    | 7314153018311 | 5  | 216 |
| 902T-055-150    | 7314153018328 | 5  | 216 |
| 902T-060-150    | 7314153018335 | 5  | 216 |
| 902T-070-175    | 7314153018342 | 5  | 216 |
| 902T-080-175    | 7314153018359 | 5  | 216 |
| 902T-090-175    | 7314153018366 | 5  | 216 |
| 902T-100-175    | 7314153018373 | 5  | 216 |
| 902T-110-175    | 7314153018380 | 5  | 216 |
| 902T-120-175    | 7314153018397 | 5  | 216 |
| 902T-130-175    | 7314153018403 | 5  | 216 |
| 9031            | 7314150110988 | 5  | 38  |
| 9031 C          | 7314150113507 | 5  | 38  |
| 9031 P-1        | 7314150266302 | 1  | 39  |
| 9031-1          | 7314150239597 | 1  | 39  |
| 9031-8224       | 7314150321193 | 3  | 258 |
| 9031-T          | 7314150131648 | 5  | 38  |
| 9031P           | 7314150187539 | 5  | 38  |
| 9031T-1         | 7314150312146 | 1  | 39  |
| 9033            | 7314150181414 | 5  | 38  |
| 9033-1          | 7314150353804 | 1  | 39  |
| 9035            | 7314150181421 | 5  | 38  |
| 9035-1          | 7314150353811 | 1  | 39  |
| 903T-1          | 7314153018410 | 1  | 215 |
| 903T-2          | 7314153018427 | 1  | 215 |
| 903T-3          | 7314153018434 | 1  | 215 |
| 9045-B-200      | 7311518012175 | 6  | 544 |
| 9045-B-250      | 7311518012182 | 6  | 544 |
| 9045-B-300      | 7311518012199 | 6  | 544 |
| 9045-B-400      | 7311518178123 | 1  | 544 |
| 9048-200        | 7314150138159 | 10 | 544 |
| 9048-250        | 7314150138166 | 10 | 544 |
| 9048-300        | 7314150138173 | 10 | 544 |



|                |               |    |     |
|----------------|---------------|----|-----|
| 9048-350       | 7314150180349 | 10 | 544 |
| 9048-400       | 7314150138180 | 10 | 544 |
| 904T-060-150   | 7314153019837 | 5  | 217 |
| 905T-060-100   | 7314153019844 | 5  | 216 |
| 9070           | 7314150100170 | 5  | 38  |
| 9070 P         | 7314150103416 | 5  | 38  |
| 9070 P-1       | 7314150239610 | 1  | 39  |
| 9070 PC        | 7314150103423 | 5  | 38  |
| 9070C          | 7314150100187 | 5  | 38  |
| 9071           | 7314150100194 | 5  | 38  |
| 9071 P         | 7314150103430 | 5  | 38  |
| 9071 P-1       | 7314150239627 | 1  | 39  |
| 9071 PC        | 7314150103447 | 5  | 38  |
| 9071C          | 7314150100200 | 5  | 38  |
| 9072           | 7314150055609 | 5  | 38  |
| 9072 C         | 7314150055616 | 5  | 38  |
| 9072 P         | 7314150056354 | 5  | 38  |
| 9072 P-1       | 7314150239634 | 1  | 39  |
| 9072 PC        | 7314150056361 | 5  | 38  |
| 9073           | 7314150101702 | 5  | 38  |
| 9073 C         | 7314150101719 | 3  | 38  |
| 9073 P         | 7314150101726 | 5  | 38  |
| 9073 P-1       | 7314150239641 | 1  | 39  |
| 9073 PC        | 7314150101733 | 3  | 38  |
| 91-023-5P      | 7311518032593 | 1  | 138 |
| 91-027-5P      | 7311518032616 | 1  | 138 |
| 91-143-100P    | 7311518224363 | 1  | 138 |
| 91-143-25P     | 7311518266578 | 1  | 138 |
| 91-143-5P      | 7311518032630 | 1  | 138 |
| 91-148-5P      | 7311518032654 | 1  | 138 |
| 91-223-5P      | 7311518032661 | 1  | 138 |
| 91-226-5P      | 7311518032685 | 1  | 138 |
| 91-233-5P      | 7311518260057 | 1  | 138 |
| 91-243-5P      | 7311518032692 | 1  | 138 |
| 91-2PW-5P      | 7311518260163 | 1  | 138 |
| 91-3PM-5P      | 7311518260156 | 1  | 138 |
| 91-412-5P      | 7311518260040 | 1  | 138 |
| 91-433-5P      | 7311518260101 | 1  | 138 |
| 91-434-5P      | 7311518260026 | 1  | 138 |
| 91-443-5P      | 7311518032722 | 1  | 138 |
| 91-444-5P      | 7311518260033 | 1  | 138 |
| 91-4PWM-5P     | 7311518260170 | 1  | 138 |
| 91-502-5P      | 7311518032746 | 1  | 138 |
| 91-512-25P     | 7311518266592 | 1  | 138 |
| 91-512-5P      | 7311518032753 | 1  | 138 |
| 91-517-5P      | 7311518032777 | 1  | 138 |
| 91-522-5P      | 7311518032784 | 1  | 138 |
| 91-611-5P      | 7311518260071 | 1  | 138 |
| 91-612-5P      | 7311518032814 | 1  | 138 |
| 91-622-5P      | 7311518260088 | 1  | 138 |
| 91-623-5P      | 7311518260064 | 1  | 138 |
| 91-7V1-5P      | 7311518260118 | 1  | 138 |
| 91-METAL-10P   | 7314150449477 | 1  | 138 |
| 91-MIXED-10P   | 7314150449491 | 1  | 138 |
| 91-WOOD-10P    | 7314150449446 | 1  | 138 |
| 91C            | 7314150182381 | 5  | 40  |
| 92-001-1P      | 7314150474998 | 90 | 140 |
| 92-106-1P      | 7314150474899 | 90 | 139 |
| 92-113-1P      | 7314150474912 | 90 | 140 |
| 92-118-1P      | 7314150474950 | 90 | 140 |
| 92-133-1P      | 7314150474134 | 70 | 139 |
| 92-133-3P      | 7314150474158 | 46 | 139 |
| 92-136-1P      | 7314150474783 | 20 | 141 |
| 92-136-G120-5P | 7314150498079 | 10 | 141 |
| 92-136-G240-5P | 7314150498116 | 10 | 141 |
| 92-136-G40-5P  | 7314150497997 | 10 | 141 |
| 92-136-G80-5P  | 7314150498031 | 10 | 141 |
| 92-137-1P      | 7314150475070 | 50 | 141 |
| 92-137-G120-5P | 7314150498093 | 10 | 141 |
| 92-137-G240-5P | 7314150498130 | 10 | 141 |
| 92-137-G40-5P  | 7314150498017 | 10 | 141 |
| 92-137-G80-5P  | 7314150498055 | 10 | 141 |
| 92-157-1P      | 7314150474820 | 70 | 139 |
| 92-160-1P      | 7314150474172 | 70 | 139 |
| 92-160-3P      | 7314150474196 | 46 | 139 |
| 92-165-1P      | 7314150475018 | 90 | 140 |
| 92-166-1P      | 7314150474974 | 50 | 140 |
| 92-174-1P      | 7314150474936 | 90 | 140 |
| 92-205-1P      | 7314150474219 | 70 | 139 |
| 92-205-3P      | 7314150474356 | 46 | 139 |
| 92-221-1P      | 7314150474721 | 70 | 139 |
| 92-222-1P      | 7314150474592 | 70 | 139 |
| 92-222-3P      | 7314150474370 | 46 | 139 |
| 92-223-1P      | 7314150474684 | 70 | 139 |
| 92-223-3P      | 7314150474400 | 46 | 139 |
| 92-225-1P      | 7314150474707 | 70 | 139 |
| 92-226-1P      | 7314150475032 | 90 | 140 |
| 92-228-1P      | 7314150474745 | 70 | 139 |
| 92-229-1P      | 7314150474769 | 70 | 139 |
| 92-236-1P      | 7314150474806 | 70 | 139 |
| 92-245-1P      | 7314150475056 | 90 | 140 |
| 92-251-1P      | 7314150474868 | 70 | 140 |
| 92-WM-SET-8P   | 7314150486830 | 34 | 140 |
| 9210           | 7311518278182 | 1  | 640 |
| 9210-1         | 7311518278212 | 1  | 640 |
| 9210-10        | 7311518278229 | 1  | 640 |





|                |               |    |     |
|----------------|---------------|----|-----|
| 9210-1060177   | 7311518295424 | 1  | 641 |
| 9210-1060238   | 7311518295394 | 20 | 641 |
| 9210-1230219   | 7311518295387 | 20 | 641 |
| 9210-1230235   | 7311518295325 | 1  | 640 |
| 9210-1320281   | 7311518295431 | 10 | 641 |
| 9210-1640142   | 7311518295356 | 1  | 640 |
| 9210-1690148   | 7311518295332 | 1  | 640 |
| 9210-1700118   | 7311518295363 | 1  | 641 |
| 9210-1710266   | 7311518295417 | 1  | 641 |
| 9210-1720100   | 7311518295295 | 1  | 640 |
| 9210-1730107   | 7311518295349 | 10 | 640 |
| 9210-1770106   | 7311518295370 | 10 | 641 |
| 9210-1830137   | 7311518295400 | 1  | 641 |
| 9210-20        | 7311518278236 | 1  | 640 |
| 92C            | 7314150182398 | 5  | 40  |
| 93C            | 7314150182404 | 5  | 40  |
| 94C            | 7314150182411 | 5  | 40  |
| 9500DZ-1.13/16 | 7314150227501 | 1  | 101 |
| 9500DZ-1.5/8   | 7314150227495 | 1  | 101 |
| 9500DZ-1.7/8   | 7314150227518 | 1  | 101 |
| 9500DZ-2       | 7314150227525 | 1  | 101 |
| 9500DZ-2.1/2   | 7314150227570 | 1  | 101 |
| 9500DZ-2.1/4   | 7314150227556 | 1  | 101 |
| 9500DZ-2.1/8   | 7314150227532 | 1  | 101 |
| 9500DZ-2.15/16 | 7314150227617 | 1  | 101 |
| 9500DZ-2.3/16  | 7314150227549 | 1  | 101 |
| 9500DZ-2.3/4   | 7314150227600 | 1  | 101 |
| 9500DZ-2.3/8   | 7314150227563 | 1  | 101 |
| 9500DZ-2.5/8   | 7314150227594 | 1  | 101 |
| 9500DZ-2.9/16  | 7314150227587 | 1  | 101 |
| 9500DZ-3       | 7314150227624 | 1  | 101 |
| 9500DZ-3.1/8   | 7314150227631 | 1  | 101 |
| 9500SM-41      | 7314153013699 | 1  | 101 |
| 9500SM-46      | 7314153013705 | 1  | 101 |
| 9500SM-50      | 7314153013712 | 1  | 101 |
| 9500SM-54      | 7314153013729 | 1  | 101 |
| 9500SM-55      | 7314153013736 | 1  | 101 |
| 9500SM-58      | 7314153013743 | 1  | 101 |
| 9500SM-60      | 7314153013750 | 1  | 101 |
| 9500SM-63      | 7314153013767 | 1  | 101 |
| 9500SM-65      | 7314153013774 | 1  | 101 |
| 9500SM-67      | 7314153013781 | 1  | 101 |
| 9500SM-70      | 7314153013798 | 1  | 101 |
| 9500SM-71      | 7314153013804 | 1  | 101 |
| 9500SM-75      | 7314153013811 | 1  | 101 |
| 9500SM-77      | 7314153013828 | 1  | 101 |
| 9500SM-80      | 7314153013835 | 1  | 101 |
| 9500SM-82      | 7314153013842 | 1  | 101 |
| 9505-3400      | 7314150125517 | 1  | 114 |
| 9505-TM        | 7314150125487 | 1  | 114 |
| 95155B-3000    | 7314150415410 | 1  | 114 |
| 9525-10        | 7311518031817 | 1  | 156 |
| 9525-3400      | 7314150125524 | 1  | 114 |
| 9525-7         | 7311518031800 | 1  | 156 |
| 9525CR-4000    | 7314150415465 | 1  | 114 |
| 9526B-4500     | 7314150415427 | 1  | 114 |
| 9527CR-2000    | 7314150415458 | 1  | 114 |
| 9528-MD-15-45  | 7311518007447 | 10 | 155 |
| 9540DZ         | 7314150414048 | 1  | 78  |
| 9540DZL        | 7314150414055 | 1  | 78  |
| 9540MB         | 7314153014108 | 1  | 77  |
| 9540MBL        | 7314153014115 | 1  | 77  |
| 9550N          | 7314150424160 | 1  | 102 |
| 9550N-SPARE    | 7314150424153 | 1  | 102 |
| 9550N/A        | 7314150424146 | 1  | 102 |
| 9550N/B        | 7314150424788 | 1  | 102 |
| 9555           | 7314153014047 | 1  | 101 |
| 9555AB         | 7314153014061 | 1  | 101 |
| 956            | 7314150025190 | 1  | 572 |
| 9560AB         | 7314153014078 | 1  | 101 |
| 9563AB         | 7314153014085 | 1  | 101 |
| 9565AB         | 7314153014092 | 1  | 102 |
| 9566A          | 7314150220618 | 1  | 101 |
| 9572           | 7314150178599 | 5  | 40  |
| 9572-200       | 7311518004231 | 20 | 544 |
| 9572-250       | 7311518004248 | 20 | 544 |
| 9574-200       | 7314150138197 | 10 | 544 |
| 9574-250       | 7314150138203 | 10 | 544 |
| 9574-300       | 7314150180356 | 10 | 544 |
| 9575-250       | 7314150185894 | 6  | 544 |
| 95C            | 7314150182428 | 1  | 40  |
| 960100010      | 8413345031073 | 1  | 461 |
| 960100020      | 8413345031080 | 1  | 461 |
| 960100030      | 8413345031097 | 1  | 461 |
| 960100050      | 8413345031103 | 1  | 461 |
| 960100060      | 8413345031110 | 1  | 461 |
| 9625-6.35QC    | 7314150441716 | 1  | 156 |
| 9625-9500      | 7314150125555 | 1  | 114 |
| 96255CR-7000   | 7314150415489 | 1  | 114 |
| 9626-10        | 7314150388844 | 1  | 154 |
| 9626-11        | 7314150388851 | 1  | 154 |
| 9626-12        | 7314150388868 | 1  | 154 |
| 9626-13        | 7314150388875 | 1  | 154 |
| 9626-14        | 7314150388882 | 1  | 154 |
| 9626-15        | 7314150444526 | 1  | 154 |
| 9626-16        | 7314150388899 | 1  | 154 |



|             |               |    |     |
|-------------|---------------|----|-----|
| 9626-18     | 7314150388905 | 1  | 154 |
| 9626-20     | 7314150388912 | 1  | 154 |
| 9626-22     | 7314150388929 | 1  | 154 |
| 9626-23     | 7314150388936 | 1  | 154 |
| 9626-24     | 7314150388943 | 1  | 154 |
| 9626-25     | 7314150388950 | 1  | 154 |
| 9626-26     | 7314153024237 | 1  | 154 |
| 9626-28     | 7314150388967 | 1  | 154 |
| 9626-30     | 7314150388974 | 1  | 154 |
| 9626-32     | 7314150388981 | 1  | 154 |
| 9626-35     | 7314150444533 | 1  | 154 |
| 9626-6      | 7314150388806 | 1  | 154 |
| 9626-7      | 7314150388813 | 1  | 154 |
| 9626-8      | 7314150388820 | 1  | 154 |
| 9626-9      | 7314150388837 | 1  | 154 |
| 9627-10-460 | 7314150389018 | 1  | 154 |
| 9627-12-460 | 7314150389025 | 1  | 154 |
| 9627-14-460 | 7314150389032 | 1  | 154 |
| 9627-16-460 | 7314150389049 | 1  | 154 |
| 9627-18-460 | 7314150389056 | 1  | 154 |
| 9627-20-460 | 7314150389063 | 1  | 154 |
| 9627-22-460 | 7314150389070 | 1  | 154 |
| 9627-24-460 | 7314150389087 | 1  | 154 |
| 9627-26-460 | 7314150389094 | 1  | 154 |
| 9627-28-460 | 7314150389100 | 1  | 154 |
| 9627-30-460 | 7314150389117 | 1  | 154 |
| 9627-32-460 | 7314150389124 | 1  | 154 |
| 9627-6-460  | 7314150388998 | 1  | 154 |
| 9627-8-460  | 7314150389001 | 1  | 154 |
| 9629-10     | 7314150388479 | 1  | 155 |
| 9629-12     | 7314150388486 | 1  | 155 |
| 9629-13     | 7314150440238 | 1  | 155 |
| 9629-14     | 7314150388493 | 1  | 155 |
| 9629-16     | 7314150388509 | 1  | 155 |
| 9629-17     | 7314150440245 | 1  | 155 |
| 9629-18     | 7314150388516 | 1  | 155 |
| 9629-19     | 7314150440252 | 1  | 155 |
| 9629-20     | 7314150388523 | 1  | 155 |
| 9629-22     | 7314150388530 | 1  | 155 |
| 9629-24     | 7314150388547 | 1  | 155 |
| 9629-25     | 7314150388554 | 1  | 155 |
| 9629-26     | 7314150388561 | 1  | 155 |
| 9629-28     | 7314150388578 | 1  | 155 |
| 9629-30     | 7314150388585 | 1  | 155 |
| 9629-32     | 7314150388592 | 1  | 155 |
| 9629-35     | 7314150440269 | 1  | 155 |
| 9629-36     | 7314150388608 | 1  | 155 |
| 9629-38     | 7314150388615 | 1  | 155 |
| 9629-40     | 7314150388622 | 1  | 155 |
| 9629-6      | 7314150388417 | 1  | 155 |
| 9629-8      | 7314150388462 | 1  | 155 |
| 9629-SET-8  | 7314150441648 | 12 | 155 |
| 9631-10-400 | 7314150388684 | 1  | 155 |
| 9631-12-400 | 7314150388691 | 1  | 155 |
| 9631-13-400 | 7314150447572 | 1  | 155 |
| 9631-14-400 | 7314150388707 | 1  | 155 |
| 9631-16-400 | 7314150388714 | 1  | 155 |
| 9631-18-400 | 7314150388721 | 1  | 155 |
| 9631-19-400 | 7314150447589 | 1  | 155 |
| 9631-20-400 | 7314150388738 | 1  | 155 |
| 9631-22-400 | 7314150388745 | 1  | 155 |
| 9631-24-400 | 7314150388752 | 1  | 155 |
| 9631-25-400 | 7314150432066 | 1  | 155 |
| 9631-28-400 | 7314150388776 | 1  | 155 |
| 9631-30-400 | 7314150388783 | 1  | 155 |
| 9631-32-400 | 7314150388790 | 1  | 155 |
| 9631-35-400 | 7314150447596 | 1  | 155 |
| 9631-38-400 | 7314150447602 | 1  | 155 |
| 9631-6-400  | 7314150388646 | 1  | 155 |
| 9631-8-400  | 7314150388677 | 1  | 155 |
| 9646-10     | 7314150388264 | 1  | 155 |
| 9646-10-250 | 7314150388387 | 1  | 155 |
| 9646-11     | 7314150388288 | 1  | 155 |
| 9646-12     | 7314150388295 | 1  | 155 |
| 9646-12-250 | 7314150388400 | 1  | 155 |
| 9646-13     | 7314150388301 | 1  | 155 |
| 9646-14     | 7314150388318 | 1  | 155 |
| 9646-15     | 7314150388325 | 1  | 155 |
| 9646-16     | 7314150388332 | 1  | 155 |
| 9646-18     | 7314150388349 | 1  | 155 |
| 9646-20     | 7314150388356 | 1  | 155 |
| 9646-3      | 7314150388189 | 1  | 155 |
| 9646-4      | 7314150388202 | 1  | 155 |
| 9646-5      | 7314150388219 | 1  | 155 |
| 9646-6      | 7314150388226 | 1  | 155 |
| 9646-6-250  | 7314150388363 | 1  | 155 |
| 9646-7      | 7314150388233 | 1  | 155 |
| 9646-8      | 7314150388240 | 1  | 155 |
| 9646-8-250  | 7314150388370 | 1  | 155 |
| 9646-9      | 7314150388257 | 1  | 155 |
| 9646-SET-5  | 7314150441686 | 1  | 155 |
| 9646-SET-8  | 7314150441693 | 1  | 155 |
| 9656-SET-6  | 7314150486953 | 1  | 155 |
| 96C         | 7314150134120 | 1  | 40  |
| 97-1        | 7314150366637 | 1  | 117 |
| 97-1/2      | 7314150366545 | 1  | 117 |





|              |               |    |     |
|--------------|---------------|----|-----|
| 97-1/4       | 7314150366507 | 1  | 117 |
| 97-10        | 7314150366286 | 1  | 117 |
| 97-11        | 7314150366293 | 1  | 117 |
| 97-11/16     | 7314150366583 | 1  | 117 |
| 97-12        | 7314150366309 | 1  | 117 |
| 97-13        | 7314150366316 | 1  | 117 |
| 97-13/16     | 7314150366606 | 1  | 117 |
| 97-14        | 7314150366323 | 1  | 117 |
| 97-15        | 7314150366330 | 1  | 117 |
| 97-15/16     | 7314150366620 | 1  | 117 |
| 97-16        | 7314150366347 | 1  | 117 |
| 97-17        | 7314150366354 | 1  | 117 |
| 97-17/32     | 7314150366552 | 1  | 117 |
| 97-18        | 7314150366361 | 1  | 117 |
| 97-19        | 7314150366378 | 1  | 117 |
| 97-21        | 7314150366385 | 1  | 117 |
| 97-22        | 7314150349722 | 1  | 117 |
| 97-24        | 7314150357048 | 1  | 117 |
| 97-27        | 7314150366392 | 1  | 117 |
| 97-3/4       | 7314150366590 | 1  | 117 |
| 97-3/8       | 7314150366521 | 1  | 117 |
| 97-30        | 7314150366408 | 1  | 117 |
| 97-32        | 7314150366415 | 1  | 117 |
| 97-5/16      | 7314150366514 | 1  | 117 |
| 97-5/8       | 7314150366576 | 1  | 117 |
| 97-7         | 7314150366255 | 1  | 117 |
| 97-7/16      | 7314150366538 | 1  | 117 |
| 97-7/8       | 7314150366613 | 1  | 117 |
| 97-8         | 7314150366262 | 1  | 117 |
| 97-9         | 7314150366279 | 1  | 117 |
| 97-9/16      | 7314150366569 | 1  | 117 |
| 9710-10-175  | 7314151785789 | 5  | 217 |
| 9710-3.5-75  | 7314151785192 | 10 | 217 |
| 9710-5.5-100 | 7314151785352 | 10 | 217 |
| 9710-6.5-125 | 7314151785437 | 10 | 217 |
| 9710-8-150   | 7314151785512 | 5  | 217 |
| 9710/S6      | 7314151802301 | 1  | 217 |
| 9715-14-250  | 7314153010148 | 5  | 218 |
| 9733         | 7314150103256 | 1  | 257 |
| 9778-1       | 7314151793524 | 10 | 217 |
| 9778-2       | 7314151793531 | 10 | 217 |
| 9778-3       | 7314151793548 | 5  | 217 |
| 9778PZD-1    | 7314151823535 | 10 | 217 |
| 9778PZD-2    | 7314151823542 | 10 | 217 |
| 97C          | 7314150128211 | 1  | 40  |
| 98-1/2       | 7314150367481 | 1  | 118 |
| 98-1/4       | 7314150367443 | 1  | 118 |
| 98-10        | 7314150367320 | 1  | 118 |
| 98-11        | 7314150367337 | 1  | 118 |
| 98-11/16     | 7314150367511 | 1  | 118 |
| 98-12        | 7314150367344 | 1  | 118 |
| 98-13        | 7314150367351 | 1  | 118 |
| 98-13/16     | 7314150367535 | 1  | 118 |
| 98-14        | 7314150367368 | 1  | 118 |
| 98-15        | 7314150367375 | 1  | 118 |
| 98-16        | 7314150367382 | 1  | 118 |
| 98-17        | 7314150367399 | 1  | 118 |
| 98-18        | 7314150367405 | 1  | 118 |
| 98-19        | 7314150367412 | 1  | 118 |
| 98-21        | 7314150367429 | 1  | 118 |
| 98-22        | 7314150367436 | 1  | 118 |
| 98-3/4       | 7314150367528 | 1  | 118 |
| 98-3/8       | 7314150367467 | 1  | 118 |
| 98-5/16      | 7314150367450 | 1  | 118 |
| 98-5/8       | 7314150367504 | 1  | 118 |
| 98-7         | 7314150367290 | 1  | 118 |
| 98-7/16      | 7314150367474 | 1  | 118 |
| 98-7/8       | 7314150367542 | 1  | 118 |
| 98-8         | 7314150367306 | 1  | 118 |
| 98-9         | 7314150367313 | 1  | 118 |
| 98-9/16      | 7314150367498 | 1  | 118 |
| 981001100    | 7314150219902 | 1  | 450 |
| 982000170    | 7314150219926 | 1  | 464 |
| 982000320    | 7314150219919 | 1  | 464 |
| 982000350    | 7314150219933 | 1  | 464 |
| 983000320    | 7314150219940 | 1  | 441 |
| 983100320    | 7314150219964 | 1  | 441 |
| 984010320    | 7314150219971 | 1  | 441 |
| 9841         | 7314150107445 | 1  | 465 |
| 9848         | 7314150111015 | 1  | 465 |
| 98505        | 7314150216321 | 5  | 215 |
| 9852         | 7314150114092 | 1  | 465 |
| 9853         | 7314150103287 | 1  | 258 |
| 9855         | 7314150111848 | 1  | 655 |
| 9857         | 7314150114283 | 1  | 655 |
| 9858         | 7314150111862 | 1  | 655 |
| 9859         | 7314150113057 | 1  | 655 |
| 9860         | 7314150522859 | 1  | 655 |
| 9861         | 7314150522873 | 1  | 655 |
| 9862         | 7314150522897 | 1  | 655 |
| 9863         | 7314150522910 | 1  | 655 |
| 9873         | 7314150058082 | 1  | 258 |
| 9883         | 7314150043293 | 1  | 571 |
| 9897         | 7314150058068 | 1  | 259 |
| 9897G/3      | 7314150470020 | 1  | 259 |
| 9897S/3      | 7314150470044 | 1  | 503 |



|               |               |   |     |
|---------------|---------------|---|-----|
| 99-1/2        | 7314150368150 | 1 | 118 |
| 99-10         | 7314150368013 | 1 | 119 |
| 99-11         | 7314150368020 | 1 | 119 |
| 99-11/16      | 7314150368181 | 1 | 119 |
| 99-12         | 7314150368037 | 1 | 119 |
| 99-13         | 7314150368044 | 1 | 119 |
| 99-14         | 7314150368051 | 1 | 119 |
| 99-16         | 7314150368068 | 1 | 119 |
| 99-17         | 7314150368075 | 1 | 119 |
| 99-18         | 7314150368082 | 1 | 119 |
| 99-19         | 7314150368099 | 1 | 119 |
| 99-21         | 7314150368105 | 1 | 119 |
| 99-22         | 7314150368112 | 1 | 119 |
| 99-24         | 7314150368129 | 1 | 119 |
| 99-3/4        | 7314150368198 | 1 | 119 |
| 99-3/8        | 7314150368136 | 1 | 118 |
| 99-5/8        | 7314150368174 | 1 | 119 |
| 99-7/16       | 7314150368143 | 1 | 118 |
| 99-9/16       | 7314150368167 | 1 | 119 |
| 9938          | 7314150056491 | 1 | 251 |
| 9A-14         | 7314150368204 | 1 | 119 |
| 9B-1/4        | 7314150366071 | 1 | 116 |
| 9B-5/16       | 7314150366088 | 1 | 116 |
| 9F-1/2        | 7314150366194 | 1 | 116 |
| 9F-1/4        | 7314150366170 | 1 | 116 |
| 9F-3/8        | 7314150366187 | 1 | 116 |
| 9P-1/2        | 7314150366057 | 1 | 116 |
| 9P-1/4        | 7314150366033 | 1 | 116 |
| 9P-3/8        | 7314150366040 | 1 | 116 |
| 9Q-1/2        | 7314150366019 | 1 | 116 |
| 9Q-1/4        | 7314150365999 | 1 | 116 |
| 9Q-3/8        | 7314150366002 | 1 | 116 |
| 9R-1/2        | 7314150365913 | 1 | 115 |
| 9R-1/4        | 7314150365890 | 1 | 115 |
| 9R-3/8        | 7314150365906 | 1 | 115 |
| 9T-1/2        | 7314150366118 | 1 | 116 |
| 9T-1/4        | 7314150366095 | 1 | 116 |
| 9T-3/8        | 7314150366101 | 1 | 116 |
| 9W            | 7314150354399 | 1 | 119 |
| A0313M03      | 7311518023706 | 1 | 144 |
| A0313M03E     | 7311518192150 | 1 | 144 |
| A0313M03X     | 7311518182038 | 1 | 144 |
| A0313M03XE    | 7311518181475 | 1 | 144 |
| A0313M03XE-60 | 7311518184513 | 1 | 144 |
| A0313M03XE-80 | 7311518201357 | 1 | 144 |
| A0314I03      | 7314150501243 | 5 | 147 |
| A0613M03X     | 7311518197872 | 1 | 144 |
| A0616AL06E    | 7311518181802 | 1 | 145 |
| A0616M06      | 7311518023737 | 1 | 144 |
| A0616M06E     | 7311518023751 | 1 | 144 |
| A0616M06X     | 7311518023768 | 1 | 144 |
| A0616M06XE    | 7311518181468 | 1 | 144 |
| A0618I06      | 7314150501267 | 5 | 147 |
| A0618S06E     | 7314150501786 | 5 | 146 |
| A0625M06X     | 7311518197780 | 1 | 146 |
| A0820M06      | 7311518023805 | 1 | 144 |
| A0820M06E     | 7311518023829 | 1 | 144 |
| A0820M06X     | 7311518023836 | 1 | 144 |
| A0820M06XE    | 7311518181994 | 1 | 144 |
| A1020I06      | 7314150501304 | 5 | 147 |
| A1020M06      | 7311518023874 | 1 | 144 |
| A1020M06E     | 7311518023898 | 1 | 144 |
| A1020M06X     | 7311518023904 | 1 | 144 |
| A1020M06XE    | 7311518182007 | 1 | 144 |
| A1020S06      | 7314150501335 | 5 | 146 |
| A1020S06E     | 7314150501793 | 5 | 146 |
| A1225AL06E    | 7311518187620 | 1 | 145 |
| A1225AL08E    | 7311518181819 | 1 | 145 |
| A1225I06      | 7314150506729 | 5 | 147 |
| A1225M06      | 7311518023942 | 1 | 144 |
| A1225M06E     | 7311518023966 | 1 | 144 |
| A1225M06X     | 7311518023973 | 1 | 144 |
| A1225M08      | 7311518100506 | 1 | 144 |
| A1225M08E     | 7311518100520 | 1 | 144 |
| A1225M08X     | 7311518187989 | 1 | 144 |
| A1225M08XE    | 7311518192174 | 1 | 144 |
| A1225S06      | 7314150501427 | 5 | 146 |
| A1225S06E     | 7314150501809 | 5 | 146 |
| A1625AL08XE   | 7311518244033 | 1 | 145 |
| A1625M06      | 7311518192181 | 1 | 144 |
| A1625M06X     | 7311518187361 | 1 | 144 |
| A1625M06XE    | 7311518187354 | 1 | 144 |
| A1625M08      | 7311518100568 | 1 | 144 |
| A1625M08E     | 7311518100582 | 1 | 144 |
| A1625M08X     | 7311518100599 | 1 | 144 |
| A1625M08XE    | 7311518182021 | 1 | 144 |
| A6700DM-10    | 7314151821722 | 5 | 79  |
| A6700DM-11    | 7314151821739 | 5 | 79  |
| A6700DM-12    | 7314151821746 | 5 | 79  |
| A6700DM-13    | 7314151821753 | 5 | 79  |
| A6700DM-14    | 7314151821760 | 5 | 79  |
| A6700DM-5     | 7314150220632 | 5 | 79  |
| A6700DM-5.5   | 7314151821678 | 5 | 79  |
| A6700DM-6     | 7314151821685 | 5 | 79  |
| A6700DM-7     | 7314151821692 | 5 | 79  |
| A6700DM-8     | 7314151821708 | 5 | 79  |



|               |               |   |    |
|---------------|---------------|---|----|
| A6700DM-9     | 7314151821715 | 5 | 79 |
| A6700DZ-1/2   | 7314151751883 | 5 | 79 |
| A6700DZ-1/4   | 7314151751371 | 5 | 79 |
| A6700DZ-11/32 | 7314151819842 | 5 | 79 |
| A6700DZ-3/16  | 7314151751029 | 5 | 79 |
| A6700DZ-3/8   | 7314151751616 | 5 | 79 |
| A6700DZ-5/16  | 7314151751531 | 5 | 79 |
| A6700DZ-7/16  | 7314151819859 | 5 | 79 |
| A6700DZ-7/32  | 7314151751296 | 5 | 79 |
| A6700DZ-9/16  | 7314151751968 | 5 | 79 |
| A6700DZ-9/32  | 7314151751456 | 5 | 79 |
| A6709M-2.5    | 7314151753740 | 1 | 83 |
| A6709M-3      | 7314151753825 | 1 | 83 |
| A6709M-4      | 7314151754129 | 1 | 83 |
| A6709M-5      | 7314151754471 | 1 | 83 |
| A6709M-6      | 7314151754556 | 1 | 83 |
| A6709MZ/9     | 7314150512096 | 1 | 68 |
| A6709Z-1/8    | 7314151755447 | 1 | 83 |
| A6709Z-3/16   | 7314151755874 | 1 | 83 |
| A6709Z-5/32   | 7314151755799 | 1 | 83 |
| A6709Z-9/64   | 7314151755522 | 1 | 83 |
| A6710DM-10    | 7314151756765 | 1 | 80 |
| A6710DM-11    | 7314151756840 | 1 | 80 |
| A6710DM-12    | 7314151756925 | 1 | 80 |
| A6710DM-13    | 7314151757069 | 1 | 80 |
| A6710DM-14    | 7314151757144 | 1 | 80 |
| A6710DM-5.5   | 7314151756178 | 1 | 80 |
| A6710DM-6     | 7314151756253 | 1 | 80 |
| A6710DM-7     | 7314151756338 | 1 | 80 |
| A6710DM-8     | 7314151756413 | 1 | 80 |
| A6710DM-9     | 7314151756680 | 1 | 80 |
| A6710DZ-1/2   | 7314151820466 | 1 | 80 |
| A6710DZ-1/4   | 7314151757229 | 1 | 80 |
| A6710DZ-11/32 | 7314151757571 | 1 | 80 |
| A6710DZ-3/16  | 7314151820435 | 1 | 80 |
| A6710DZ-3/8   | 7314151757656 | 1 | 80 |
| A6710DZ-5/16  | 7314151757496 | 1 | 80 |
| A6710DZ-7/16  | 7314151757731 | 1 | 80 |
| A6710DZ-7/32  | 7314151820442 | 1 | 80 |
| A6710DZ-9/16  | 7314151820473 | 1 | 80 |
| A6710DZ-9/32  | 7314151820459 | 1 | 80 |
| A6716DM       | 7314151820824 | 1 | 65 |
| A6716DZ       | 7314151820831 | 1 | 67 |
| A6718DZ       | 7314150312450 | 1 | 68 |
| A6800DM-10    | 7314151821845 | 1 | 79 |
| A6800DM-11    | 7314151821852 | 1 | 79 |
| A6800DM-12    | 7314151821869 | 1 | 79 |
| A6800DM-13    | 7314151821876 | 1 | 79 |
| A6800DM-14    | 7314151821883 | 1 | 79 |
| A6800DM-4     | 7314151821777 | 1 | 79 |
| A6800DM-5     | 7314151821784 | 1 | 79 |
| A6800DM-5.5   | 7314151821791 | 1 | 79 |
| A6800DM-6     | 7314151821807 | 1 | 79 |
| A6800DM-7     | 7314151821814 | 1 | 79 |
| A6800DM-8     | 7314151821821 | 1 | 79 |
| A6800DM-9     | 7314151821838 | 1 | 79 |
| A6800DZ-1/2   | 7314151758899 | 1 | 80 |
| A6800DZ-1/4   | 7314151758387 | 1 | 80 |
| A6800DZ-11/32 | 7314151803872 | 1 | 80 |
| A6800DZ-3/16  | 7314151758035 | 1 | 80 |
| A6800DZ-3/8   | 7314151758622 | 1 | 80 |
| A6800DZ-5/16  | 7314151758547 | 1 | 80 |
| A6800DZ-7/16  | 7314151803889 | 1 | 80 |
| A6800DZ-7/32  | 7314151758110 | 1 | 80 |
| A6800DZ-9/16  | 7314151758974 | 1 | 80 |
| A6800DZ-9/32  | 7314151758462 | 1 | 80 |
| A6800SM-10    | 7314150360147 | 1 | 80 |
| A6800SM-11    | 7314150360154 | 1 | 80 |
| A6800SM-12    | 7314150360161 | 1 | 80 |
| A6800SM-13    | 7314150360178 | 1 | 80 |
| A6800SM-14    | 7314150360185 | 1 | 80 |
| A6800SM-15    | 7314150360192 | 1 | 80 |
| A6800SM-4     | 7314150360208 | 1 | 80 |
| A6800SM-4.5   | 7314150360215 | 1 | 80 |
| A6800SM-5     | 7314150360222 | 1 | 80 |
| A6800SM-6     | 7314150360239 | 1 | 80 |
| A6800SM-7     | 7314150360246 | 1 | 80 |
| A6800SM-8     | 7314150360253 | 1 | 80 |
| A6800SM-9     | 7314150360260 | 1 | 80 |
| A6800SZ-1/8   | 7314150360277 | 1 | 80 |
| A6800SZ-5/32  | 7314150360284 | 1 | 80 |
| A7400DM-10    | 7314151819972 | 5 | 85 |
| A7400DM-11    | 7314151819989 | 5 | 85 |
| A7400DM-12    | 7314151819996 | 5 | 85 |
| A7400DM-13    | 7314151820008 | 5 | 85 |
| A7400DM-14    | 7314151820015 | 5 | 85 |
| A7400DM-15    | 7314151820022 | 5 | 85 |
| A7400DM-16    | 7314151820039 | 5 | 85 |
| A7400DM-17    | 7314151820046 | 5 | 85 |
| A7400DM-18    | 7314151820053 | 5 | 85 |
| A7400DM-19    | 7314151820060 | 5 | 85 |
| A7400DM-20    | 7314151820077 | 5 | 85 |
| A7400DM-21    | 7314151820084 | 5 | 85 |
| A7400DM-22    | 7314151820091 | 5 | 85 |
| A7400DM-24    | 7314150386123 | 5 | 85 |
| A7400DM-6     | 7314150118212 | 5 | 85 |



|                 |               |    |     |
|-----------------|---------------|----|-----|
| A7400DM-7       | 7314150118229 | 5  | 85  |
| A7400DM-8       | 7314150118236 | 5  | 85  |
| A7400DM-9       | 7314151819965 | 5  | 85  |
| A7400DZ-1/2     | 7314151759780 | 5  | 86  |
| A7400DZ-1/4     | 7314151759193 | 5  | 86  |
| A7400DZ-11/16   | 7314151819897 | 5  | 86  |
| A7400DZ-13/16   | 7314151819910 | 5  | 86  |
| A7400DZ-17/32   | 7314151819866 | 5  | 86  |
| A7400DZ-19/32   | 7314151819873 | 5  | 86  |
| A7400DZ-3/4     | 7314151819903 | 5  | 86  |
| A7400DZ-3/8     | 7314151759438 | 5  | 86  |
| A7400DZ-5/16    | 7314151759278 | 5  | 86  |
| A7400DZ-5/8     | 7314151819880 | 5  | 86  |
| A7400DZ-7/16    | 7314151759513 | 5  | 86  |
| A7400DZ-7/8     | 7314151819927 | 5  | 86  |
| A7400DZ-9/16    | 7314151759865 | 5  | 86  |
| A7402DM-10      | 7314151820138 | 5  | 86  |
| A7402DM-11      | 7314151820145 | 1  | 86  |
| A7402DM-12      | 7314151820152 | 1  | 86  |
| A7402DM-13      | 7314151820169 | 1  | 86  |
| A7402DM-14      | 7314151820176 | 1  | 86  |
| A7402DM-15      | 7314151820183 | 1  | 86  |
| A7402DM-16      | 7314151820190 | 1  | 86  |
| A7402DM-17      | 7314151820206 | 1  | 86  |
| A7402DM-18      | 7314151820213 | 1  | 86  |
| A7402DM-19      | 7314151820220 | 1  | 86  |
| A7402DM-21      | 7314150385881 | 1  | 86  |
| A7402DM-7       | 7314150220243 | 1  | 86  |
| A7402DM-8       | 7314150220250 | 1  | 86  |
| A7402DM-9       | 7314150220267 | 1  | 86  |
| A7402DZ-1/2     | 7314151760526 | 1  | 86  |
| A7402DZ-1/4     | 7314151759940 | 1  | 86  |
| A7402DZ-11/16   | 7314151820114 | 1  | 86  |
| A7402DZ-13/16   | 7314153003027 | 1  | 86  |
| A7402DZ-19/32   | 7314153003041 | 1  | 86  |
| A7402DZ-3/4     | 7314151820121 | 1  | 86  |
| A7402DZ-3/8     | 7314151760366 | 1  | 86  |
| A7402DZ-5/16    | 7314151760014 | 1  | 86  |
| A7402DZ-5/8     | 7314151820107 | 1  | 86  |
| A7402DZ-7/16    | 7314151760441 | 1  | 86  |
| A7402DZ-7/8     | 7314153003034 | 1  | 86  |
| A7402DZ-9/16    | 7314151760793 | 1  | 86  |
| A7410DZ-1/2     | 7314153006301 | 1  | 86  |
| A7410DZ-11/16   | 7314153006332 | 1  | 86  |
| A7410DZ-3/4     | 7314153006349 | 1  | 86  |
| A7410DZ-3/8     | 7314153006288 | 1  | 86  |
| A7410DZ-5/16    | 7314153006271 | 1  | 86  |
| A7410DZ-5/8     | 7314153006325 | 1  | 86  |
| A7410DZ-7/16    | 7314153006295 | 1  | 86  |
| A7410DZ-9/16    | 7314153006318 | 1  | 86  |
| A7435DME        | 7314153015006 | 1  | 70  |
| A7440DME        | 7314153015419 | 1  | 70  |
| A7535DZE        | 7314153015013 | 1  | 71  |
| ADJUST 3        | 7314150103515 | 1  | 39  |
| ADJUST 3-90     | 7314150236336 | 1  | 38  |
| ADJUST 9031/29  | 7314150302925 | 3  | 39  |
| AP-234-F        | 7311518289027 | 2  | 628 |
| AP-3M           | 7311518152062 | 1  | 626 |
| AP-5M           | 7311518152079 | 1  | 626 |
| APB260          | 7314150389162 | 10 | 612 |
| APB360          | 7314150389186 | 10 | 612 |
| AS-1200         | 7314150321520 | 3  | 545 |
| AS-C33-JT-F     | 7314150341672 | 15 | 636 |
| AS-C36-JT-M     | 7311518337490 | 15 | 636 |
| AS-C39-JT-C     | 7314150341542 | 15 | 636 |
| AS-C45-JT-C     | 7314150341559 | 15 | 636 |
| ASP-1850        | 7311518337124 | 1  | 627 |
| ASP-1850G       | 7311518337131 | 1  | 627 |
| ASP-AS          | 7311518337377 | 6  | 627 |
| ASP-AS-C33-JT-F | 7314150341665 | 5  | 629 |
| ASP-AS-C36-JT-M | 7314150340590 | 5  | 629 |
| ASP-AS-C39-JT-C | 7314150341535 | 5  | 629 |
| ASP-AS-C45-JT-C | 7314150341566 | 2  | 629 |
| ASP-AS-HOOK     | 7311518337582 | 4  | 627 |
| ASP-ATP         | 7311518337384 | 6  | 627 |
| ASP3740-C36JTM  | 7314150341818 | 1  | 630 |
| ASP3740-C39JTC  | 7314150353347 | 1  | 630 |
| ASP3740-C45JTC  | 7314150353354 | 1  | 630 |
| ASP3740-P3437   | 7314150341801 | 1  | 628 |
| ATP-110-210     | 7311518337575 | 1  | 626 |
| ATP-200-350     | 7311518347062 | 1  | 626 |
| ATP-200-500     | 7311518347055 | 1  | 626 |
| ATP-230-410     | 7311518337599 | 2  | 627 |
| AUTO            | 7314150438082 | 1  | 375 |
| B141.007.075    | 7314150278404 | 5  | 206 |
| B141.008.075    | 7314150278411 | 5  | 206 |
| B141.009.075    | 7314150278428 | 5  | 206 |
| B141.010.075    | 7314150278435 | 5  | 206 |
| B141.015.100    | 7314150278442 | 5  | 206 |
| B141.020.100    | 7314150278459 | 5  | 206 |
| B141.025.125    | 7314150278466 | 5  | 206 |
| B141.027.125    | 7314150278473 | 5  | 206 |
| B141.030.150    | 7314150278480 | 5  | 206 |
| B141.040.150    | 7314150278497 | 5  | 206 |
| B142.000.075    | 7314150278718 | 10 | 496 |
| B142.001.080    | 7314150278725 | 10 | 496 |





# B142.001.150



|              |               |    |     |
|--------------|---------------|----|-----|
| B142.001.150 | 7314150343188 | 10 | 496 |
| B142.002.100 | 7314150278732 | 10 | 496 |
| B142.002.175 | 7314150343195 | 10 | 496 |
| B142.003.150 | 7314150278749 | 10 | 496 |
| B143.020.100 | 7314150278510 | 5  | 206 |
| B143.025.100 | 7314150278503 | 10 | 206 |
| B143.030.100 | 7314150278527 | 10 | 206 |
| B143.040.100 | 7314150278534 | 10 | 206 |
| B143.050.100 | 7314150278541 | 10 | 206 |
| B143.060.125 | 7314150278558 | 10 | 206 |
| B143.080.150 | 7314150278565 | 5  | 206 |
| B144.001.100 | 7314150278787 | 5  | 206 |
| B144.002.125 | 7314150278794 | 5  | 206 |
| B144.003.150 | 7314150278800 | 5  | 206 |
| B145.006.100 | 7314150278756 | 5  | 207 |
| B146.006.100 | 7314150278763 | 5  | 207 |
| B147.001.400 | 7314150285594 | 1  | 371 |
| B147.003.400 | 7314150285600 | 1  | 371 |
| B148.001.080 | 7314150314522 | 10 | 496 |
| B148.002.100 | 7314150314539 | 10 | 496 |
| B149.001.080 | 7314150314546 | 10 | 496 |
| B149.002.100 | 7314150314553 | 10 | 496 |
| B150.010.100 | 7314150343126 | 10 | 496 |
| B150.015.125 | 7314150343133 | 10 | 496 |
| B150.020.125 | 7314150343140 | 10 | 496 |
| B150.025.150 | 7314150343157 | 10 | 496 |
| B190.040.075 | 7314150277810 | 10 | 204 |
| B190.040.100 | 7314150277827 | 10 | 204 |
| B190.055.100 | 7314150277834 | 10 | 204 |
| B190.055.125 | 7314150277841 | 10 | 204 |
| B190.065.125 | 7314150277858 | 10 | 204 |
| B190.065.150 | 7314150277865 | 10 | 204 |
| B190.080.150 | 7314150277872 | 10 | 204 |
| B190.080.175 | 7314150277889 | 10 | 204 |
| B190.100.200 | 7314150277896 | 10 | 204 |
| B190.120.250 | 7314150277902 | 10 | 204 |
| B190.140.250 | 7314150277919 | 10 | 204 |
| B191.025.075 | 7314150277926 | 10 | 204 |
| B191.030.075 | 7314150277933 | 10 | 204 |
| B191.030.100 | 7314150277940 | 10 | 204 |
| B191.030.200 | 7314150277957 | 10 | 204 |
| B191.035.100 | 7314150277964 | 10 | 204 |
| B191.040.100 | 7314150277971 | 10 | 204 |
| B191.040.125 | 7314150277988 | 10 | 204 |
| B191.040.250 | 7314150277995 | 10 | 204 |
| B191.055.125 | 7314150278008 | 10 | 204 |
| B191.055.150 | 7314150278015 | 10 | 204 |
| B191.055.300 | 7314150278022 | 10 | 204 |
| B191.065.150 | 7314150278039 | 10 | 204 |
| B191.065.300 | 7314150278046 | 10 | 204 |
| B192.000.075 | 7314150278084 | 10 | 205 |
| B192.000.200 | 7314150278091 | 10 | 205 |
| B192.001.100 | 7314150278107 | 10 | 205 |
| B192.001.250 | 7314150278114 | 10 | 205 |
| B192.002.125 | 7314150278121 | 10 | 205 |
| B192.002.150 | 7314150442720 | 10 | 205 |
| B192.002.300 | 7314150278138 | 10 | 205 |
| B192.003.150 | 7314150278145 | 10 | 205 |
| B192.004.200 | 7314150278169 | 10 | 205 |
| B193.000.075 | 7314150278190 | 10 | 205 |
| B193.001.100 | 7314150278206 | 10 | 205 |
| B193.002.125 | 7314150278213 | 10 | 205 |
| B193.003.150 | 7314150278220 | 10 | 205 |
| B193.004.200 | 7314150278237 | 10 | 205 |
| B194.004.075 | 7314150278268 | 10 | 206 |
| B194.005.075 | 7314150278275 | 10 | 206 |
| B194.006.075 | 7314150278282 | 10 | 206 |
| B194.007.075 | 7314150278299 | 10 | 206 |
| B194.008.075 | 7314150278305 | 10 | 206 |
| B194.009.075 | 7314150278312 | 10 | 206 |
| B194.010.075 | 7314150278329 | 10 | 206 |
| B194.015.100 | 7314150278336 | 10 | 206 |
| B194.020.100 | 7314150278343 | 10 | 206 |
| B194.025.125 | 7314150278350 | 10 | 206 |
| B194.027.125 | 7314150278367 | 10 | 206 |
| B194.030.150 | 7314150278374 | 10 | 206 |
| B194.040.150 | 7314150278381 | 10 | 206 |
| B194.045.150 | 7314150278398 | 5  | 206 |
| B195.001.025 | 7314150278176 | 10 | 205 |
| B195.002.025 | 7314150278183 | 10 | 205 |
| B195.006.050 | 7314150289493 | 5  | 207 |
| B195.040.025 | 7314150278053 | 10 | 204 |
| B195.050.025 | 7314150278060 | 10 | 204 |
| B195.060.025 | 7314150278077 | 10 | 204 |
| B195.901.025 | 7314150278244 | 10 | 205 |
| B195.902.025 | 7314150278251 | 10 | 205 |
| B196.025.075 | 7314150278589 | 10 | 495 |
| B196.030.100 | 7314150278572 | 10 | 495 |
| B196.035.100 | 7314150278596 | 10 | 495 |
| B196.040.100 | 7314150278602 | 10 | 495 |
| B196.055.125 | 7314150278619 | 10 | 495 |
| B196.065.150 | 7314150278626 | 10 | 495 |
| B196.080.175 | 7314150278633 | 10 | 495 |
| B196.100.200 | 7314150278640 | 10 | 495 |
| B196.120.200 | 7314150278657 | 10 | 495 |
| B197.000.075 | 7314150278664 | 10 | 496 |



|               |               |    |     |
|---------------|---------------|----|-----|
| B197.001.080  | 7314150278671 | 10 | 496 |
| B197.001.150  | 7314150343164 | 10 | 496 |
| B197.002.100  | 7314150278688 | 10 | 496 |
| B197.002.175  | 7314150343171 | 10 | 496 |
| B197.003.150  | 7314150278695 | 10 | 496 |
| B197.004.200  | 7314150278701 | 10 | 496 |
| B198.040.125  | 7314150278817 | 5  | 207 |
| B198.045.125  | 7314150278824 | 5  | 207 |
| B198.050.150  | 7314150278831 | 5  | 207 |
| B198.055.150  | 7314150281268 | 5  | 207 |
| B198.060.150  | 7314150281763 | 5  | 207 |
| B198.060.150F | 7314150281770 | 5  | 207 |
| B198.070.150  | 7314150281787 | 5  | 207 |
| B198.070.150F | 7314150281794 | 5  | 207 |
| B198.080.150  | 7314150281800 | 5  | 207 |
| B198.080.150F | 7314150281817 | 5  | 207 |
| B198.090.150  | 7314150281824 | 5  | 207 |
| B198.100.150  | 7314150281831 | 5  | 207 |
| B198.110.150  | 7314150281848 | 5  | 207 |
| B198.120.150  | 7314150281855 | 5  | 207 |
| B198.130.150  | 7314150281862 | 5  | 207 |
| B198.140.150  | 7314150281879 | 5  | 207 |
| B199.055.125  | 7314150281886 | 5  | 496 |
| B199.060.125  | 7314150281893 | 5  | 496 |
| B199.070.125  | 7314150281909 | 5  | 496 |
| B199.080.125  | 7314150281916 | 5  | 496 |
| B199.090.125  | 7314150281923 | 5  | 496 |
| B199.100.125  | 7314150281930 | 5  | 496 |
| B199.110.125  | 7314150281947 | 5  | 496 |
| B199.120.125  | 7314150287741 | 5  | 496 |
| B199.130.125  | 7314150287772 | 5  | 496 |
| B219.002      | 7314150289301 | 1  | 200 |
| B219.004      | 7314150283248 | 1  | 200 |
| B219.005      | 7314150283255 | 1  | 201 |
| B219.006      | 7314150283293 | 1  | 202 |
| B219.007      | 7314150283323 | 1  | 202 |
| B219.008      | 7314150283347 | 1  | 203 |
| B219.010      | 7314150283354 | 1  | 204 |
| B219.012      | 7314150327768 | 1  | 200 |
| B219.014      | 7314150533985 | 1  | 200 |
| B219.015      | 7314150283262 | 1  | 201 |
| B219.016      | 7314150283309 | 1  | 202 |
| B219.017      | 7314150283330 | 1  | 202 |
| B219.025      | 7314150283279 | 1  | 201 |
| B219.026      | 7314150283316 | 1  | 202 |
| B219.027      | 7314150399833 | 1  | 203 |
| B219.035      | 7314150283286 | 1  | 201 |
| B219.045      | 7314150533992 | 1  | 201 |
| B219.110      | 7314150392667 | 1  | 203 |
| B219.210      | 7314150438969 | 1  | 203 |
| B220.002      | 7314150289295 | 1  | 496 |
| B220.005      | 7314150283361 | 1  | 497 |
| B220.007      | 7314150283385 | 1  | 497 |
| B220.012      | 7314150314614 | 1  | 496 |
| B220.015      | 7314150283378 | 1  | 497 |
| B220.017      | 7314150283392 | 1  | 497 |
| B220.027      | 7314150283408 | 1  | 497 |
| B400.002      | 8412814119441 | 1  | 608 |
| B400.003      | 8412814119458 | 1  | 608 |
| B400.004      | 8412814119465 | 1  | 608 |
| B400.005      | 8412814119472 | 1  | 608 |
| B400.006      | 8412814119489 | 1  | 608 |
| B400.007      | 8412814119496 | 1  | 608 |
| B400.008      | 8412814119502 | 1  | 609 |
| B400.009      | 8412814119519 | 1  | 609 |
| B400.010      | 8412814119526 | 1  | 609 |
| B400.011      | 8412814119533 | 1  | 609 |
| B400.012      | 8412814119540 | 1  | 609 |
| B400.013      | 8412814119557 | 1  | 609 |
| B400.014      | 8412814119564 | 1  | 609 |
| B400.015      | 8412814119571 | 1  | 609 |
| B400.016      | 8412814119588 | 1  | 609 |
| B400.017      | 8412814119595 | 1  | 609 |
| B400.018      | 8412814119601 | 1  | 609 |
| B400.019      | 8412814119618 | 1  | 609 |
| B400.020      | 8412814119625 | 1  | 609 |
| B400.021      | 8412814119632 | 1  | 609 |
| B400.022      | 8412814119649 | 1  | 609 |
| B400.023      | 8412814119656 | 1  | 609 |
| B400.024      | 8412814119663 | 1  | 609 |
| B400.025      | 8412814119670 | 1  | 609 |
| B400.026      | 8412814119687 | 1  | 609 |
| B400.027      | 8412814119694 | 1  | 609 |
| B400.028      | 8412814119700 | 1  | 609 |
| B400.029      | 8412814119717 | 1  | 609 |
| B400.030      | 8412814119724 | 1  | 609 |
| B400.031      | 8412814119731 | 1  | 609 |
| B400.032      | 8412814119748 | 1  | 609 |
| B400.033      | 8412814119755 | 1  | 609 |
| B400.034      | 8412814119762 | 1  | 609 |
| B400.035      | 8412814119779 | 1  | 609 |
| B400.036      | 8412814119786 | 1  | 609 |
| B400.037      | 8412814119793 | 1  | 609 |
| B400.038      | 8412814119800 | 1  | 609 |
| B400.039      | 8412814119816 | 1  | 609 |
| B400.040      | 8412814119823 | 1  | 609 |



|                |               |    |     |
|----------------|---------------|----|-----|
| B400.041       | 8412814119830 | 1  | 609 |
| B400.042       | 8412814119847 | 1  | 609 |
| B400.043       | 8412814119854 | 1  | 609 |
| B400.044       | 8412814119861 | 1  | 609 |
| B400.045       | 8412814119878 | 1  | 609 |
| B400.046       | 8412814119885 | 1  | 609 |
| B400.047       | 8412814119892 | 1  | 609 |
| B400.048       | 8412814119908 | 1  | 609 |
| B400.049       | 8412814119915 | 1  | 609 |
| B400.050       | 8412814119922 | 1  | 609 |
| B705.1/4.125   | 7314150281978 | 5  | 216 |
| BAC007         | 7314150242337 | 1  | 313 |
| BASIC          | 7314150437436 | 1  | 375 |
| BB10           | 7314150240586 | 1  | 338 |
| BBA1224-3200   | 7314150341955 | 1  | 337 |
| BBAGM12-1200   | 7314150535675 | 1  | 337 |
| BBAGM1224-2400 | 7314150535682 | 1  | 337 |
| BBAGMBAT       | 7314150537709 | 1  | 337 |
| BBAGMCAB       | 7314150537723 | 1  | 337 |
| BBAGMCHG       | 7314150537747 | 1  | 337 |
| BBBCAB-AUZ     | 7314150183944 | 1  | 341 |
| BBBCAB-EU      | 7314150186648 | 1  | 341 |
| BBBCAB-UK      | 7314150183937 | 1  | 341 |
| BBC420         | 7314150243235 | 1  | 338 |
| BBC620         | 7314150243242 | 1  | 338 |
| BBCE12-10      | 7314150330263 | 2  | 338 |
| BBCE12-15S     | 7314150406722 | 2  | 338 |
| BBCE12-3       | 7314150330249 | 2  | 338 |
| BBCE12-6       | 7314150330256 | 2  | 338 |
| BBCE12-F100    | 7314150344710 | 1  | 338 |
| BBCE24-10      | 7314150330287 | 2  | 338 |
| BBCEC1         | 7314150335459 | 1  | 340 |
| BBCEC2         | 7314150337460 | 1  | 341 |
| BB CER1        | 7314150335466 | 1  | 340 |
| BB CER2        | 7314150337484 | 1  | 341 |
| BBH12-1200     | 7314150360734 | 1  | 337 |
| BBJL1630       | 7314150244898 | 5  | 338 |
| BBJL2535       | 7314150209453 | 1  | 338 |
| BBJL3545       | 7314150209460 | 1  | 338 |
| BBR100         | 7314150345922 | 1  | 324 |
| BBR110         | 7314150170562 | 1  | 325 |
| BBR1501        | 7314150439119 | 24 | 328 |
| BBR201P6       | 7314150205752 | 8  | 327 |
| BBR201P64014   | 7314150237852 | 1  | 327 |
| BBR201P64016   | 7314150237753 | 1  | 327 |
| BBR201P64018   | 7314150237760 | 1  | 327 |
| BBR201P67814   | 7314150237777 | 1  | 327 |
| BBR201P67816   | 7314150237784 | 1  | 327 |
| BBR201P67818   | 7314150237791 | 1  | 327 |
| BBR202P4       | 7314150205769 | 1  | 327 |
| BBR202P410     | 7314150207688 | 1  | 327 |
| BBR202P414     | 7314150207695 | 1  | 327 |
| BBR202P419     | 7314150207701 | 1  | 327 |
| BBR202P455     | 7314150231393 | 1  | 327 |
| BBR203P9       | 7314150208081 | 1  | 327 |
| BBR203P920     | 7314150231102 | 1  | 327 |
| BBR203P925     | 7314150231119 | 1  | 327 |
| BBR203P927     | 7314150231126 | 1  | 327 |
| BBR203P930     | 7314150231133 | 1  | 327 |
| BBR203P940     | 7314150231140 | 1  | 327 |
| BBR203P945     | 7314150231157 | 1  | 327 |
| BBR203P950     | 7314150231164 | 1  | 327 |
| BBR203P955     | 7314150231171 | 1  | 327 |
| BBR203P960     | 7314150231188 | 1  | 327 |
| BBR204         | 7314150430635 | 6  | 328 |
| BBR210P3       | 7314150206056 | 1  | 327 |
| BBR300P50      | 7314150269624 | 4  | 327 |
| BBR320         | 7314150169887 | 1  | 326 |
| BBR350         | 7314150169900 | 1  | 325 |
| BBR400         | 7314150345939 | 1  | 326 |
| BBR405         | 7314150435807 | 20 | 326 |
| BBR410         | 7314150345946 | 24 | 326 |
| BBR420         | 7314150403394 | 50 | 326 |
| BBR501011      | 7314150438143 | 50 | 325 |
| BBR50121314    | 7314150438150 | 50 | 325 |
| BBR6131        | 7314150239443 | 1  | 328 |
| BBR6135        | 7314150239450 | 1  | 327 |
| BBRAS14        | 7314150416943 | 4  | 325 |
| BBRAS14-01     | 7314150418060 | 1  | 325 |
| BBRAS14-02     | 7314150418077 | 1  | 325 |
| BBRAS14-03     | 7314150418084 | 1  | 325 |
| BBRAS14-04     | 7314150418091 | 1  | 325 |
| BBRAS14-05     | 7314150418107 | 1  | 325 |
| BBRAS14-06     | 7314150418114 | 1  | 325 |
| BBRAS14-07     | 7314150418121 | 1  | 325 |
| BBRAS14-08     | 7314150418138 | 1  | 325 |
| BBRAS14-09     | 7314150418145 | 1  | 325 |
| BBRAS14-10     | 7314150418152 | 1  | 325 |
| BBRAS14-11     | 7314150418169 | 1  | 325 |
| BBRAS14-12     | 7314150418176 | 1  | 325 |
| BBRAS14-13     | 7314150418183 | 1  | 325 |
| BBRAS14-14     | 7314150418190 | 1  | 325 |
| BBRBB12        | 7314150371297 | 1  | 325 |
| BBRFKM1        | 7314150384938 | 12 | 328 |
| BBRPTG1        | 7314150412617 | 10 | 325 |
| BBRS210P       | 7314150206070 | 1  | 327 |



|            |               |    |     |
|------------|---------------|----|-----|
| BBRS210P2  | 7314150206063 | 1  | 327 |
| BBS075     | 7314150249824 | 12 | 344 |
| BBS100     | 7314150169870 | 1  | 348 |
| BBS10001   | 7314150207183 | 1  | 348 |
| BBS10002   | 7314150207190 | 1  | 348 |
| BBS10003   | 7314150207206 | 1  | 348 |
| BBS10004   | 7314150207213 | 1  | 348 |
| BBS10005   | 7314150207220 | 1  | 348 |
| BBS100057  | 7314150186655 | 1  | 348 |
| BBS10006   | 7314150207237 | 1  | 348 |
| BBS10007   | 7314150207244 | 1  | 348 |
| BBS10008   | 7314150207251 | 1  | 348 |
| BBS10009   | 7314150207268 | 1  | 348 |
| BBS10010   | 7314150207275 | 1  | 348 |
| BBS101     | 7314150243525 | 1  | 345 |
| BBS102     | 7314150243518 | 1  | 345 |
| BBS103     | 7314150243488 | 1  | 345 |
| BBS10450   | 7314150243501 | 1  | 345 |
| BBS105     | 7314150250868 | 1  | 345 |
| BBS106     | 7314150243495 | 1  | 345 |
| BBS107     | 7314150250875 | 1  | 345 |
| BBS108     | 7314150250882 | 1  | 345 |
| BBS12SH    | 7314150243563 | 1  | 346 |
| BBS150     | 7314150169849 | 1  | 344 |
| BBS150R    | 7314150244959 | 1  | 345 |
| BBS150S    | 7314150244973 | 1  | 345 |
| BBS150T    | 7314150244966 | 1  | 345 |
| BBS165     | 7314150205615 | 10 | 345 |
| BBS165SP4  | 7314150205622 | 50 | 346 |
| BBS170P13  | 7314150205608 | 1  | 346 |
| BBS170P131 | 7314150231843 | 1  | 346 |
| BBS170P132 | 7314150231850 | 1  | 346 |
| BBS170P133 | 7314150231867 | 1  | 346 |
| BBS170P134 | 7314150231874 | 1  | 346 |
| BBS170P135 | 7314150231881 | 1  | 346 |
| BBS170P136 | 7314150231898 | 1  | 346 |
| BBS170P137 | 7314150231904 | 1  | 346 |
| BBS170P138 | 7314150231911 | 1  | 346 |
| BBS170P139 | 7314150231928 | 1  | 346 |
| BBS200     | 7314150239498 | 1  | 348 |
| BBS20P12   | 7314150169856 | 1  | 348 |
| BBS210     | 7314150215362 | 1  | 348 |
| BBS210U06  | 7314150217656 | 1  | 348 |
| BBS210U08  | 7314150217663 | 1  | 348 |
| BBS210UA06 | 7314150217670 | 1  | 348 |
| BBS210UA08 | 7314150217687 | 1  | 348 |
| BBS210V06  | 7314150217632 | 1  | 348 |
| BBS210V08  | 7314150217649 | 1  | 348 |
| BBS210W06  | 7314150218738 | 1  | 348 |
| BBS210W08  | 7314150218745 | 1  | 348 |
| BBS3BH1    | 7314150356843 | 1  | 344 |
| BBS3BH1-VP | 7314150355501 | 40 | 344 |
| BBS3UH     | 7314150242351 | 1  | 344 |
| BBS50      | 7314150169863 | 1  | 343 |
| BBSDA      | 7314150247127 | 1  | 347 |
| BBSDC      | 7314150247158 | 6  | 347 |
| BBSDD      | 7314150247165 | 1  | 347 |
| BBSDH      | 7314150247141 | 1  | 347 |
| BBSDHR     | 7314150249299 | 1  | 347 |
| BBSDT      | 7314150247134 | 6  | 347 |
| BBSDW      | 7314150247110 | 6  | 347 |
| BBSH1F     | 7314150247189 | 1  | 346 |
| BBSH1M     | 7314150247196 | 1  | 346 |
| BBSH2CA    | 7314150247202 | 1  | 346 |
| BBSH2CA    | 7314150247219 | 12 | 346 |
| BBSH2CP    | 7314150247226 | 6  | 346 |
| BBSH2F     | 7314150247172 | 6  | 346 |
| BBSH3CF    | 7314150247240 | 6  | 346 |
| BBSH3CF30  | 7314150247264 | 6  | 346 |
| BBSH3FS    | 7314150247257 | 6  | 346 |
| BBSH3MF    | 7314150247233 | 1  | 347 |
| BBSHWH1    | 7314150328932 | 1  | 347 |
| BBSS1      | 7314150247288 | 1  | 347 |
| BBSS2      | 7314150247271 | 8  | 347 |
| BBSS2L     | 7314150247295 | 1  | 347 |
| BBT20      | 7314150166961 | 1  | 339 |
| BBT60A     | 7314150504169 | 36 | 339 |
| BBT80      | 7314150327805 | 6  | 339 |
| BCL31B1    | 7314150389704 | 1  | 293 |
| BCL31C1    | 7314150389742 | 1  | 293 |
| BCL31D1    | 7314150389582 | 1  | 291 |
| BCL31D1K1  | 7314150400843 | 1  | 291 |
| BCL31IS1   | 7314150389599 | 1  | 291 |
| BCL31IS1K1 | 7314150400836 | 1  | 291 |
| BCL31IW1   | 7314150389551 | 1  | 290 |
| BCL31IW1K1 | 7314150400829 | 1  | 290 |
| BCL31R1    | 7314150389568 | 1  | 290 |
| BCL31R1K1  | 7314150400850 | 1  | 291 |
| BCL31SD1   | 7314150389575 | 1  | 291 |
| BCL31SD1K1 | 7314150402656 | 1  | 291 |
| BCL32B1    | 7314150389711 | 1  | 293 |
| BCL32DG1   | 7314150389605 | 1  | 292 |
| BCL32DG1K1 | 7314150402670 | 1  | 292 |
| BCL32G1    | 7314150389629 | 1  | 293 |
| BCL32G1K1  | 7314150400911 | 1  | 292 |
| BCL32IW1   | 7314150389643 | 1  | 290 |





# BCL32IW1K1



|                 |               |    |     |
|-----------------|---------------|----|-----|
| BCL32IW1K1      | 7314150402663 | 1  | 290 |
| BCL32RS1        | 7314150389636 | 1  | 292 |
| BCL32RS1K1      | 7314150400904 | 1  | 292 |
| BCL32SP1        | 7314150389612 | 1  | 292 |
| BCL32SP1K1      | 7314150400898 | 1  | 292 |
| BCL33AP1        | 7314150389650 | 1  | 292 |
| BCL33AP1K1      | 7314150402687 | 1  | 292 |
| BCL33B1         | 7314150389728 | 1  | 293 |
| BCL33B3         | 7314150389735 | 1  | 293 |
| BCL33C1         | 7314150389759 | 1  | 293 |
| BCL33C2         | 7314150389766 | 1  | 293 |
| BCL33D1         | 7314150389681 | 1  | 291 |
| BCL33D1K1       | 7314150400881 | 1  | 291 |
| BCL33IW1        | 7314150389667 | 1  | 290 |
| BCL33IW1K1      | 7314150400867 | 10 | 290 |
| BCL33IW2        | 7314150389674 | 1  | 290 |
| BCL33IW2K1      | 7314150400874 | 1  | 290 |
| BDACM1000       | 7314150500819 | 30 | 339 |
| BE-3529         | 7314151847845 | 5  | 536 |
| BE-6400M-4      | 7314153011145 | 5  | 194 |
| BE-6400M-5      | 7314153011169 | 5  | 194 |
| BE-6400M-5.5    | 7314153011176 | 5  | 194 |
| BE-6400M-7      | 7314153011190 | 5  | 194 |
| BE-6902         | 7314150242641 | 5  | 193 |
| BE-6903         | 7314150242665 | 5  | 193 |
| BE-6925         | 7314150242658 | 5  | 193 |
| BE-6990-IP10    | 7314151846763 | 1  | 112 |
| BE-6990-IP10-KL | 7314151847531 | 10 | 113 |
| BE-6990-IP15    | 7314151846770 | 1  | 112 |
| BE-6990-IP15-KL | 7314151847548 | 10 | 113 |
| BE-6990-IP20-KL | 7314151848668 | 10 | 113 |
| BE-6990-IP6     | 7314151846725 | 1  | 112 |
| BE-6990-IP6-KL  | 7314151847494 | 10 | 113 |
| BE-6990-IP7     | 7314151846732 | 1  | 112 |
| BE-6990-IP7-KL  | 7314151847500 | 10 | 113 |
| BE-6990-IP8     | 7314151846749 | 1  | 112 |
| BE-6990-IP8-KL  | 7314151847517 | 10 | 113 |
| BE-6990-IP9     | 7314151846756 | 1  | 112 |
| BE-6990-IP9-KL  | 7314151847524 | 10 | 113 |
| BE-6990-IPSET   | 7314153019356 | 1  | 113 |
| BE-6990TX-T10KL | 7314151847760 | 10 | 113 |
| BE-6990TX-T15KL | 7314151847777 | 10 | 113 |
| BE-6990TX-T20KL | 7314151848682 | 10 | 113 |
| BE-6990TX-T6-KL | 7314151847722 | 10 | 113 |
| BE-6990TX-T7-KL | 7314151847739 | 10 | 113 |
| BE-6990TX-T8-KL | 7314151847746 | 10 | 113 |
| BE-6990TX-T9-KL | 7314151847753 | 10 | 113 |
| BE-7515         | 7314150242528 | 5  | 192 |
| BE-7520         | 7314150242535 | 5  | 192 |
| BE-7525         | 7314150242542 | 5  | 192 |
| BE-7527         | 7314150242559 | 5  | 192 |
| BE-7530         | 7314150242566 | 5  | 192 |
| BE-7540         | 7314150242573 | 5  | 192 |
| BE-7606         | 7314151839017 | 5  | 195 |
| BE-7607         | 7314151839024 | 5  | 195 |
| BE-7608         | 7314151839031 | 5  | 195 |
| BE-7675         | 7314150123896 | 1  | 228 |
| BE-7715         | 7314150242580 | 5  | 192 |
| BE-7720         | 7314150242597 | 5  | 192 |
| BE-7725         | 7314150242603 | 5  | 192 |
| BE-7727         | 7314150242610 | 5  | 192 |
| BE-7730         | 7314150242627 | 5  | 192 |
| BE-7740         | 7314150242634 | 5  | 192 |
| BE-7803         | 7314151838867 | 5  | 194 |
| BE-7804         | 7314151838881 | 5  | 194 |
| BE-7805         | 7314151838904 | 5  | 194 |
| BE-7806         | 7314151838928 | 5  | 194 |
| BE-7806S        | 7314150242986 | 5  | 492 |
| BE-7807         | 7314151838935 | 5  | 194 |
| BE-7807S        | 7314150242993 | 5  | 492 |
| BE-7808         | 7314151838942 | 5  | 194 |
| BE-7808S        | 7314150243006 | 5  | 492 |
| BE-7809         | 7314151838959 | 5  | 194 |
| BE-7809S        | 7314150243013 | 5  | 492 |
| BE-7810         | 7314151838966 | 5  | 194 |
| BE-7810S        | 7314150243020 | 5  | 492 |
| BE-7811         | 7314151838973 | 5  | 194 |
| BE-7812         | 7314151838980 | 5  | 194 |
| BE-7813         | 7314151838997 | 5  | 194 |
| BE-7814         | 7314151839000 | 5  | 194 |
| BE-7835         | 7314151838874 | 5  | 194 |
| BE-7845         | 7314151838898 | 5  | 194 |
| BE-7855         | 7314151838911 | 5  | 194 |
| BE-7855S        | 7314150242979 | 5  | 492 |
| BE-7907         | 7314153010964 | 5  | 192 |
| BE-7908         | 7314153010971 | 5  | 192 |
| BE-7909         | 7314153010988 | 5  | 192 |
| BE-7910         | 7314151838799 | 5  | 192 |
| BE-7915         | 7314151838805 | 5  | 192 |
| BE-7920         | 7314151838812 | 5  | 192 |
| BE-7925         | 7314151838829 | 5  | 192 |
| BE-7927         | 7314151838836 | 5  | 192 |
| BE-7930         | 7314151838843 | 5  | 192 |
| BE-7940         | 7314151838850 | 5  | 192 |
| BE-8002         | 7314150242825 | 5  | 190 |
| BE-8010         | 7314150010615 | 5  | 190 |



|            |               |    |     |
|------------|---------------|----|-----|
| BE-8010S   | 7314150033058 | 5  | 492 |
| BE-8020    | 7314150010639 | 5  | 190 |
| BE-8020I   | 7314150270316 | 5  | 528 |
| BE-8020L   | 7314151838591 | 5  | 190 |
| BE-8022    | 7314150242474 | 5  | 190 |
| BE-8030    | 7314150010653 | 5  | 190 |
| BE-8030I   | 7314150270330 | 5  | 528 |
| BE-8040    | 7314150010677 | 5  | 190 |
| BE-8040I   | 7314150270347 | 5  | 528 |
| BE-8040S   | 7314150033089 | 5  | 492 |
| BE-8040SL  | 7314150304578 | 10 | 494 |
| BE-8050S   | 7314150033096 | 5  | 492 |
| BE-8050SL  | 7314150304592 | 10 | 494 |
| BE-8065S   | 7314150033119 | 5  | 492 |
| BE-8080-1  | 7314153010995 | 5  | 193 |
| BE-8080-10 | 7314153011060 | 5  | 193 |
| BE-8080-2  | 7314153011008 | 5  | 193 |
| BE-8080-3  | 7314153011015 | 5  | 193 |
| BE-8080-4  | 7314153011022 | 5  | 193 |
| BE-8080-5  | 7314153011039 | 5  | 193 |
| BE-8080-6  | 7314153011046 | 5  | 193 |
| BE-8080-8  | 7314153011053 | 5  | 193 |
| BE-8135TB  | 7314150275052 | 10 | 199 |
| BE-8145TB  | 7314150275076 | 10 | 199 |
| BE-8150    | 7314150010707 | 5  | 190 |
| BE-8150TB  | 7314150275113 | 10 | 199 |
| BE-8155    | 7314150010721 | 5  | 190 |
| BE-8155TB  | 7314150275090 | 5  | 199 |
| BE-8158    | 7314153010858 | 5  | 190 |
| BE-8159    | 7314153010865 | 5  | 190 |
| BE-8160    | 7314150010745 | 5  | 190 |
| BE-8210    | 7314151838584 | 5  | 190 |
| BE-8220    | 7314150047741 | 5  | 190 |
| BE-8220S   | 7314150048243 | 5  | 492 |
| BE-8220SL  | 7314150304530 | 10 | 494 |
| BE-8225    | 7314150242443 | 5  | 190 |
| BE-8230    | 7314150047758 | 5  | 190 |
| BE-8230S   | 7314150048250 | 5  | 492 |
| BE-8230SL  | 7314150304554 | 10 | 494 |
| BE-8235    | 7314150242450 | 5  | 190 |
| BE-8240    | 7314150047765 | 5  | 190 |
| BE-8241    | 7314150242467 | 5  | 190 |
| BE-8241I   | 7314150270866 | 5  | 528 |
| BE-8242    | 7314153010803 | 5  | 190 |
| BE-8250    | 7314150047772 | 5  | 190 |
| BE-8250L   | 7314151838607 | 5  | 190 |
| BE-8251    | 7314150242481 | 5  | 190 |
| BE-8252    | 7314153010810 | 5  | 190 |
| BE-8252I   | 7314150270361 | 5  | 528 |
| BE-8255    | 7314150047789 | 5  | 190 |
| BE-8255S   | 7314150048281 | 5  | 492 |
| BE-8255SL  | 7314150304615 | 10 | 494 |
| BE-8256    | 7314153010827 | 5  | 190 |
| BE-8256TB  | 7314150275137 | 10 | 199 |
| BE-8257    | 7314153010834 | 5  | 190 |
| BE-8258    | 7314153010841 | 5  | 190 |
| BE-8258S   | 7314150242818 | 5  | 492 |
| BE-8258TB  | 7314150275151 | 10 | 199 |
| BE-8259S   | 7314150242832 | 5  | 492 |
| BE-8260    | 7314150047796 | 5  | 190 |
| BE-8262TB  | 7314150275526 | 10 | 199 |
| BE-8330    | 7314151838614 | 5  | 190 |
| BE-8340    | 7314151838621 | 5  | 190 |
| BE-8350    | 7314151838638 | 5  | 190 |
| BE-8355    | 7314151838652 | 5  | 191 |
| BE-8360    | 7314151838676 | 5  | 191 |
| BE-8450    | 7314151838645 | 5  | 190 |
| BE-8455    | 7314151838669 | 5  | 190 |
| BE-8510S   | 7314150126507 | 5  | 492 |
| BE-8510SL  | 7314150304813 | 10 | 494 |
| BE-8520S   | 7314150126514 | 5  | 492 |
| BE-8520SL  | 7314150304837 | 10 | 494 |
| BE-8571    | 7314150244652 | 1  | 197 |
| BE-8572    | 7314150244669 | 1  | 197 |
| BE-8573    | 7314150244676 | 1  | 198 |
| BE-8574    | 7314150258666 | 1  | 198 |
| BE-8575    | 7314150244638 | 1  | 195 |
| BE-8576    | 7314150245741 | 1  | 198 |
| BE-8577    | 7314151839048 | 5  | 195 |
| BE-8600    | 7314150010769 | 5  | 191 |
| BE-8600I   | 7314150270378 | 5  | 528 |
| BE-8600S   | 7314150033126 | 5  | 492 |
| BE-8601    | 7314151838706 | 5  | 191 |
| BE-8602    | 7314151838713 | 5  | 191 |
| BE-8605    | 7314150242498 | 5  | 191 |
| BE-8608    | 7314150242504 | 5  | 191 |
| BE-8610    | 7314150010776 | 5  | 191 |
| BE-8610I   | 7314150270392 | 5  | 528 |
| BE-8610L   | 7314151838683 | 5  | 191 |
| BE-8610S   | 7314150033133 | 5  | 492 |
| BE-8610SL  | 7314150304639 | 10 | 494 |
| BE-8610TB  | 7314150275199 | 10 | 199 |
| BE-8611    | 7311518292317 | 5  | 191 |
| BE-8611S   | 7314150414703 | 5  | 492 |
| BE-8612S   | 7314150242856 | 5  | 492 |
| BE-8620    | 7314150010783 | 5  | 191 |

| Code         | Product       | Quantity | Price |
|--------------|---------------|----------|-------|
| BE-8620I     | 7314150270408 | 5        | 528   |
| BE-8620L     | 7314151838690 | 5        | 191   |
| BE-8620S     | 7314150033140 | 5        | 492   |
| BE-8620SL    | 7314150304653 | 10       | 494   |
| BE-8620TB    | 7314150275212 | 10       | 199   |
| BE-8621      | 7311518292324 | 5        | 191   |
| BE-8621S     | 7314150242863 | 5        | 492   |
| BE-8622      | 7314150242511 | 5        | 191   |
| BE-8622S     | 7314150242870 | 5        | 492   |
| BE-8623      | 7314153010872 | 5        | 191   |
| BE-8623I     | 7314150270415 | 5        | 528   |
| BE-8623TB    | 7314150275236 | 10       | 199   |
| BE-8624      | 7314153010889 | 5        | 191   |
| BE-8624TB    | 7314150275250 | 10       | 199   |
| BE-8628      | 7314153010896 | 5        | 191   |
| BE-8629      | 7314153010902 | 5        | 191   |
| BE-8630      | 7314150010790 | 5        | 191   |
| BE-8630S     | 7314150033157 | 5        | 492   |
| BE-8640      | 7314150010806 | 5        | 191   |
| BE-8640S     | 7314150033164 | 5        | 492   |
| BE-8675      | 7314150123872 | 1        | 228   |
| BE-8700-1/4  | 7314150242689 | 5        | 193   |
| BE-8700-3/16 | 7314150242696 | 5        | 193   |
| BE-8700-3/8  | 7314150242702 | 5        | 193   |
| BE-8700-5/16 | 7314150242719 | 5        | 193   |
| BE-8700-5/32 | 7314150242726 | 5        | 193   |
| BE-8700-7/32 | 7314150242733 | 5        | 193   |
| BE-8700-7/64 | 7314150275878 | 5        | 193   |
| BE-8702      | 7314151838768 | 5        | 193   |
| BE-8703      | 7314150027651 | 5        | 193   |
| BE-8703S     | 7314151839130 | 5        | 492   |
| BE-8704      | 7314150027668 | 5        | 193   |
| BE-8704S     | 7314151839147 | 5        | 492   |
| BE-8705      | 7314150027675 | 5        | 193   |
| BE-8705S     | 7314151839154 | 5        | 492   |
| BE-8706      | 7314150027682 | 5        | 193   |
| BE-8706S     | 7314151839161 | 5        | 492   |
| BE-8708      | 7314150027699 | 5        | 193   |
| BE-8708S     | 7314151839178 | 5        | 492   |
| BE-8710      | 7314150027705 | 5        | 193   |
| BE-8710S     | 7314150126521 | 5        | 492   |
| BE-8710SL    | 7314150304851 | 10       | 494   |
| BE-8715      | 7314150242672 | 5        | 193   |
| BE-8720S     | 7314150126538 | 5        | 492   |
| BE-8720SL    | 7314150304875 | 10       | 494   |
| BE-8725      | 7314151838775 | 5        | 193   |
| BE-8725S     | 7314151839123 | 5        | 492   |
| BE-8800      | 7314150042012 | 5        | 191   |
| BE-8800I     | 7314150270422 | 5        | 528   |
| BE-8800S     | 7314151839055 | 5        | 492   |
| BE-8801      | 7314151838744 | 5        | 192   |
| BE-8802      | 7314151838751 | 5        | 192   |
| BE-8810      | 7314150010813 | 5        | 191   |
| BE-8810I     | 7314150270439 | 5        | 528   |
| BE-8810L     | 7314151838720 | 5        | 191   |
| BE-8810S     | 7314150048298 | 5        | 492   |
| BE-8810SL    | 7314150304677 | 10       | 494   |
| BE-8810TB    | 7314150275274 | 10       | 199   |
| BE-8811      | 7311518292331 | 5        | 191   |
| BE-8811S     | 7314150414710 | 5        | 492   |
| BE-8812S     | 7314150242894 | 5        | 492   |
| BE-8820      | 7314150010820 | 5        | 191   |
| BE-8820I     | 7314150270446 | 5        | 528   |
| BE-8820L     | 7314151838737 | 5        | 191   |
| BE-8820S     | 7314150048304 | 5        | 492   |
| BE-8820SL    | 7314150304691 | 10       | 494   |
| BE-8820TB    | 7314150275298 | 10       | 199   |
| BE-8821      | 7311518292348 | 5        | 191   |
| BE-8821S     | 7314150242900 | 5        | 492   |
| BE-8822S     | 7314150242917 | 5        | 492   |
| BE-8823      | 7314153010919 | 5        | 191   |
| BE-8823I     | 7314150270453 | 5        | 528   |
| BE-8823TB    | 7314150275311 | 10       | 199   |
| BE-8824      | 7314153010926 | 5        | 191   |
| BE-8824TB    | 7314150275335 | 10       | 199   |
| BE-8828      | 7314153010933 | 5        | 191   |
| BE-8829      | 7314153010940 | 5        | 191   |
| BE-8830      | 7314150010837 | 5        | 191   |
| BE-8830S     | 7314150048311 | 5        | 492   |
| BE-8840      | 7314150010844 | 5        | 191   |
| BE-8840S     | 7314151839062 | 5        | 492   |
| BE-8865      | 7314150010851 | 5        | 190   |
| BE-8870      | 7314150010875 | 5        | 190   |
| BE-8880      | 7314150010899 | 5        | 190   |
| BE-8890      | 7314150010905 | 5        | 190   |
| BE-8904      | 7314153010957 | 5        | 192   |
| BE-8905      | 7314153010049 | 5        | 192   |
| BE-8905S     | 7314150242924 | 5        | 492   |
| BE-8906      | 7314150027729 | 5        | 192   |
| BE-8906S     | 7314150242931 | 5        | 492   |
| BE-8907      | 7314150027736 | 5        | 192   |
| BE-8907S     | 7314150242948 | 5        | 492   |
| BE-8908      | 7314150027743 | 5        | 192   |
| BE-8908S     | 7314150242955 | 5        | 492   |
| BE-8909      | 7314150027750 | 5        | 192   |
| BE-8909S     | 7314150242962 | 5        | 492   |

| Code      | Product       | Quantity | Price |
|-----------|---------------|----------|-------|
| BE-8910   | 7314150027767 | 5        | 192   |
| BE-8910I  | 7314150270460 | 5        | 528   |
| BE-8910S  | 7314151839079 | 5        | 492   |
| BE-8910SL | 7314150304714 | 5        | 494   |
| BE-8910TB | 7314150275359 | 5        | 200   |
| BE-8915   | 7314150027774 | 5        | 192   |
| BE-8915I  | 7314150270477 | 5        | 528   |
| BE-8915S  | 7314151839086 | 5        | 492   |
| BE-8915SL | 7314150304738 | 5        | 494   |
| BE-8915TB | 7314150275373 | 5        | 200   |
| BE-8920   | 7314150027781 | 5        | 192   |
| BE-8920I  | 7314150270484 | 5        | 528   |
| BE-8920S  | 7314151839093 | 5        | 492   |
| BE-8920SL | 7314150304752 | 5        | 494   |
| BE-8920TB | 7314150275397 | 5        | 200   |
| BE-8925   | 7314150027798 | 5        | 192   |
| BE-8925I  | 7314150270491 | 5        | 528   |
| BE-8925S  | 7314151839109 | 5        | 492   |
| BE-8925SL | 7314150304776 | 5        | 494   |
| BE-8925TB | 7314150275410 | 5        | 200   |
| BE-8927   | 7314150027804 | 5        | 192   |
| BE-8927TB | 7314150275434 | 5        | 200   |
| BE-8930   | 7314150027811 | 5        | 192   |
| BE-8930S  | 7314151839116 | 5        | 492   |
| BE-8930SL | 7314150304790 | 5        | 494   |
| BE-8930TB | 7314150275458 | 5        | 200   |
| BE-8940   | 7314150027828 | 5        | 192   |
| BE-8940TB | 7314150275472 | 5        | 200   |
| BE-8945   | 7314151838782 | 5        | 192   |
| BE-8975   | 7314150056576 | 6        | 227   |
| BE-8975B  | 7314150188741 | 6        | 227   |
| BE-8976B  | 7314150216369 | 6        | 228   |
| BE-8980   | 7314153010681 | 5        | 194   |
| BE-8985   | 7314153010698 | 5        | 194   |
| BE-8986   | 7314150267026 | 5        | 194   |
| BE-9001   | 7311518269005 | 5        | 193   |
| BE-9002   | 7311518269012 | 5        | 193   |
| BE-9003   | 7311518269029 | 5        | 193   |
| BE-9100   | 7314150242757 | 5        | 193   |
| BE-9101   | 7314150242764 | 5        | 193   |
| BE-9102   | 7314150242771 | 5        | 193   |
| BE-9103   | 7314150242788 | 5        | 193   |
| BE-9104   | 7314150242795 | 5        | 193   |
| BE-9105   | 7314150242801 | 5        | 193   |
| BE-9575   | 7314150123841 | 1        | 227   |
| BE-9578   | 7314150123803 | 1        | 224   |
| BE-9585   | 7314150123858 | 1        | 227   |
| BE-9586   | 7314150216000 | 1        | 224   |
| BE-9588   | 7314150123810 | 1        | 225   |
| BE-9675   | 7314150123889 | 1        | 227   |
| BE-9676   | 7314150216017 | 1        | 225   |
| BE-9678   | 7314150123827 | 1        | 225   |
| BE-9688   | 7314150123834 | 1        | 225   |
| BE-9765   | 7314150055128 | 3        | 225   |
| BE-9770   | 7314150027712 | 3        | 225   |
| BE-9770I  | 7314150276332 | 20       | 528   |
| BE-9775   | 7314150056330 | 3        | 226   |
| BE-9776   | 7314150056545 | 6        | 224   |
| BE-9776B  | 7314150216352 | 6        | 225   |
| BE-9777   | 7314150056552 | 6        | 224   |
| BE-9777B  | 7314150188734 | 6        | 224   |
| BE-9780   | 7314150033386 | 3        | 226   |
| BE-9785   | 7314150056347 | 3        | 226   |
| BE-9786I  | 7314150314485 | 1        | 529   |
| BE-9787   | 7314150056569 | 6        | 224   |
| BE-9871   | 7314150234707 | 1        | 189   |
| BE-9871SL | 7314150470792 | 1        | 495   |
| BE-9872   | 7314150440412 | 1        | 189   |
| BE-9872SL | 7314150470785 | 1        | 495   |
| BE-9875   | 7314150314444 | 1        | 189   |
| BE-9876S  | 7314150315000 | 1        | 494   |
| BE-9877   | 7314150320745 | 1        | 190   |
| BE-9878   | 7314150186259 | 1        | 222   |
| BE-9878SL | 7314150321018 | 1        | 495   |
| BE-9879   | 7314150383474 | 1        | 189   |
| BE-9880   | 7314150238569 | 3        | 223   |
| BE-9880SL | 7314150337651 | 1        | 495   |
| BE-9881   | 7314150043279 | 1        | 188   |
| BE-9881I  | 7314150270507 | 1        | 528   |
| BE-9881S  | 7314151839307 | 1        | 493   |
| BE-9881SL | 7314150304899 | 1        | 495   |
| BE-9881TB | 7314150275502 | 1        | 198   |
| BE-9882   | 7314151839284 | 1        | 188   |
| BE-9882I  | 7314150270514 | 1        | 528   |
| BE-9882S  | 7314151839314 | 1        | 493   |
| BE-9882SL | 7314150304912 | 1        | 495   |
| BE-9882TB | 7314150275496 | 1        | 199   |
| BE-9884   | 7314150243068 | 1        | 188   |
| BE-9884S  | 7314150236602 | 1        | 493   |
| BE-9885   | 7314150048465 | 1        | 188   |
| BE-9885S  | 7314150126491 | 1        | 493   |
| BE-9885TB | 7314150275519 | 1        | 199   |
| BE-9886   | 7314150048472 | 1        | 188   |
| BE-9887S  | 7314150244744 | 1        | 493   |
| BE-9888S  | 7314153006158 | 1        | 493   |
| BE-9889S  | 7314150244751 | 1        | 493   |





|                |               |    |     |
|----------------|---------------|----|-----|
| BE-9890S       | 7314150237715 | 1  | 493 |
| BE-9890SL      | 7314150315086 | 1  | 494 |
| BE-9891SL      | 7314150321506 | 1  | 494 |
| BE-9894SL      | 7314150321490 | 1  | 495 |
| BE1100         | 7314150205929 | 8  | 309 |
| BE110001       | 7314150230228 | 1  | 309 |
| BE110014       | 7314150230204 | 1  | 308 |
| BE110015       | 7314150230211 | 1  | 308 |
| BE1100AC1      | 7314150230266 | 1  | 308 |
| BE1100AC2      | 7314150333394 | 1  | 308 |
| BE1200P6       | 7314150205516 | 1  | 306 |
| BE1200P6AC1    | 7314150205523 | 1  | 306 |
| BE1205         | 7314150205554 | 1  | 306 |
| BE1210P11      | 7314150209101 | 1  | 307 |
| BE1210P1101    | 7314150269822 | 1  | 306 |
| BE1210P1102    | 7314150269839 | 1  | 306 |
| BE1210P1103    | 7314150269846 | 1  | 306 |
| BE1210P9AC1    | 7314150205547 | 1  | 307 |
| BE1300         | 7314150205578 | 1  | 305 |
| BE1300SH       | 7314150205585 | 10 | 305 |
| BE1305P450     | 7314150206032 | 1  | 305 |
| BE1305P450WS01 | 7314150269228 | 1  | 305 |
| BE1305P450WS02 | 7314150269235 | 1  | 305 |
| BE1305P450WS03 | 7314150269242 | 1  | 305 |
| BE1305P450WS04 | 7314150269327 | 1  | 305 |
| BE1305P450WS05 | 7314150269334 | 1  | 305 |
| BE1305P450WS06 | 7314150269341 | 1  | 305 |
| BE1305P450WS07 | 7314150269358 | 1  | 305 |
| BE1305P450WS08 | 7314150269365 | 1  | 305 |
| BE1305P450WS09 | 7314150269372 | 1  | 305 |
| BE1305P450WS10 | 7314150269310 | 1  | 305 |
| BE1305P450WS11 | 7314150269389 | 1  | 305 |
| BE1305P450WS12 | 7314150269396 | 1  | 305 |
| BE1305P450WS13 | 7314150269402 | 1  | 305 |
| BE1305P450WS14 | 7314150269419 | 1  | 305 |
| BE1305P450WS15 | 7314150269426 | 1  | 305 |
| BE1310P4       | 7314150205707 | 1  | 304 |
| BE1310P425     | 7314150233649 | 1  | 304 |
| BE1310P427     | 7314150233656 | 1  | 304 |
| BE1310P429     | 7314150233663 | 1  | 304 |
| BE1310P430     | 7314150233670 | 1  | 304 |
| BE1311P13      | 7314150235414 | 1  | 304 |
| BE1312DNS      | 7314150450596 | 12 | 305 |
| BE1315P7       | 7314150205776 | 1  | 305 |
| BE1315P71      | 7314150230273 | 1  | 305 |
| BE1315P72      | 7314150230280 | 1  | 305 |
| BE1315P73      | 7314150230297 | 1  | 305 |
| BE1315P74      | 7314150230303 | 1  | 305 |
| BE1315P75      | 7314150230310 | 1  | 305 |
| BE1315P76      | 7314150230327 | 1  | 305 |
| BE1315P77      | 7314150230334 | 1  | 305 |
| BE1320S17      | 7314150415366 | 10 | 304 |
| BE13ZL11       | 7314150239733 | 1  | 306 |
| BE1FFWF        | 7314150403325 | 12 | 315 |
| BE1FLD1        | 7314150250745 | 1  | 315 |
| BE1FLD2        | 7314150250752 | 1  | 315 |
| BE1FLD3        | 7314150250769 | 1  | 315 |
| BE1FLDS        | 7314150250783 | 1  | 315 |
| BE1FTW         | 7314150251209 | 1  | 315 |
| BE1GP5         | 7314150170043 | 1  | 306 |
| BE1GP5-T       | 7314150170050 | 10 | 306 |
| BE1GP510       | 7314150207732 | 1  | 307 |
| BE1GP512       | 7314150207749 | 1  | 307 |
| BE1GP514       | 7314150207756 | 1  | 307 |
| BE1GP58        | 7314150207718 | 1  | 307 |
| BE1GP59        | 7314150207725 | 1  | 307 |
| BE1P           | 7314150170067 | 1  | 307 |
| BE1SP14L       | 7314150170074 | 1  | 307 |
| BE1SP16L       | 7314150492756 | 10 | 307 |
| BE1SP1F        | 7314150435777 | 12 | 307 |
| BE1T14         | 7314150167630 | 1  | 307 |
| BE1T16         | 7314150167647 | 1  | 307 |
| BE1T21         | 7314150167654 | 1  | 307 |
| BE1TH-10       | 7314150343980 | 5  | 316 |
| BE1TH-12       | 7314150343997 | 5  | 316 |
| BE1TH-2        | 7314150343874 | 10 | 316 |
| BE1TH-2.5      | 7314150343881 | 10 | 316 |
| BE1TH-3        | 7314150343898 | 10 | 316 |
| BE1TH-3.5      | 7314150343904 | 10 | 316 |
| BE1TH-4        | 7314150343911 | 10 | 316 |
| BE1TH-4.5      | 7314150343928 | 10 | 316 |
| BE1TH-5        | 7314150343935 | 10 | 316 |
| BE1TH-6        | 7314150343942 | 10 | 316 |
| BE1TH-7        | 7314150343959 | 10 | 316 |
| BE1TH-8        | 7314150343966 | 10 | 316 |
| BE1TH-9        | 7314150343973 | 10 | 316 |
| BE1TH-S5       | 7314150457502 | 1  | 315 |
| BE1TH-S6       | 7314150344017 | 30 | 315 |
| BE1TS-10       | 7314150344062 | 10 | 316 |
| BE1TS-11       | 7314150344079 | 10 | 316 |
| BE1TS-12       | 7314150344086 | 10 | 316 |
| BE1TS-13       | 7314150344093 | 10 | 316 |
| BE1TS-14       | 7314150344109 | 10 | 316 |
| BE1TS-15       | 7314150344116 | 10 | 316 |
| BE1TS-16       | 7314150344123 | 10 | 316 |
| BE1TS-17       | 7314150344130 | 10 | 316 |



|                 |               |    |     |
|-----------------|---------------|----|-----|
| BE1TS-18        | 7314150344147 | 10 | 316 |
| BE1TS-19        | 7314150344154 | 10 | 316 |
| BE1TS-20        | 7314150344161 | 8  | 316 |
| BE1TS-21        | 7314150344178 | 8  | 316 |
| BE1TS-22        | 7314150344185 | 8  | 316 |
| BE1TS-24        | 7314150344192 | 8  | 316 |
| BE1TS-6         | 7314150344024 | 10 | 316 |
| BE1TS-7         | 7314150344031 | 10 | 316 |
| BE1TS-8         | 7314150344048 | 10 | 316 |
| BE1TS-9         | 7314150344055 | 10 | 316 |
| BE1TS-S7        | 7314150344208 | 1  | 316 |
| BE200CAB250SH10 | 7314150165452 | 1  | 360 |
| BE200CAB250SH25 | 7314150165469 | 1  | 360 |
| BE200CAB250SH3  | 7314150165445 | 1  | 360 |
| BE200CAB40F1    | 7314150165391 | 1  | 360 |
| BE200CAB55F1    | 7314150165407 | 1  | 360 |
| BE200CAB55F3    | 7314150165414 | 1  | 360 |
| BE200CAB58SR1   | 7314150165421 | 1  | 360 |
| BE200CAB58SR3   | 7314150165438 | 1  | 360 |
| BE200CAB80SR1   | 7314150165384 | 1  | 360 |
| BE200CAB80SR3   | 7314150165476 | 1  | 360 |
| BE200MAG4       | 7314150245192 | 1  | 360 |
| BE200MAG55      | 7314150165513 | 1  | 360 |
| BE200MAG80      | 7314150165551 | 1  | 360 |
| BE200MIR4035    | 7314150245161 | 1  | 360 |
| BE200MIR4055    | 7314150245185 | 1  | 360 |
| BE200MIR5535    | 7314150165483 | 1  | 360 |
| BE200MIR5545    | 7314150165490 | 1  | 360 |
| BE200MIR5555    | 7314150165506 | 1  | 360 |
| BE200MIR8035    | 7314150165520 | 1  | 360 |
| BE200MIR8045    | 7314150165537 | 1  | 360 |
| BE200MIR8055    | 7314150165544 | 1  | 360 |
| BE220           | 7314150170005 | 1  | 360 |
| BE230           | 7314150182633 | 1  | 303 |
| BE239           | 7314150243143 | 1  | 303 |
| BE240           | 7314150239917 | 1  | 303 |
| BE240-CAT       | 7314150289417 | 1  | 303 |
| BE250           | 7314150169924 | 1  | 313 |
| BE251200        | 7314150249343 | 1  | 334 |
| BE2512005       | 7314150249350 | 1  | 333 |
| BE2512008       | 7314150249367 | 1  | 334 |
| BE251A          | 7314150540136 | 12 | 313 |
| BE253           | 7314150250806 | 1  | 313 |
| BE2541          | 7314150251797 | 1  | 314 |
| BE2542          | 7314150251803 | 1  | 314 |
| BE254A          | 7314150446070 | 1  | 314 |
| BE254A-01       | 7314150453405 | 1  | 314 |
| BE256-155       | 7314150205875 | 1  | 314 |
| BE256-178       | 7314150205882 | 1  | 314 |
| BE256-250       | 7314150205899 | 1  | 314 |
| BE256M          | 7314150205851 | 1  | 314 |
| BE256P3         | 7314150205868 | 1  | 314 |
| BE257           | 7314150205844 | 8  | 304 |
| BE25710         | 7314150230549 | 1  | 304 |
| BE25718         | 7314150230532 | 1  | 304 |
| BE2572          | 7314150230556 | 1  | 304 |
| BE2576          | 7314150230525 | 1  | 304 |
| BE258           | 7314150251780 | 1  | 314 |
| BE301           | 7314150430871 | 2  | 335 |
| BE301CM         | 7314150430888 | 50 | 335 |
| BE301CM-01      | 7314150430956 | 20 | 335 |
| BE301CM-02      | 7314150430963 | 20 | 335 |
| BE310           | 7314150205943 | 8  | 336 |
| BE400P24        | 7314150205806 | 1  | 309 |
| BE400P2401      | 7314150230600 | 1  | 310 |
| BE400P2402      | 7314150230617 | 1  | 310 |
| BE400P2403      | 7314150230624 | 1  | 310 |
| BE400P2404      | 7314150230631 | 1  | 310 |
| BE400P2405      | 7314150230648 | 1  | 310 |
| BE400P2406      | 7314150230655 | 1  | 310 |
| BE400P2407      | 7314150230662 | 1  | 310 |
| BE400P2408      | 7314150230679 | 1  | 311 |
| BE400P2409      | 7314150230686 | 1  | 311 |
| BE400P241       | 7314150230563 | 1  | 309 |
| BE400P2410      | 7314150230693 | 1  | 311 |
| BE400P2411      | 7314150230709 | 1  | 311 |
| BE400P2412      | 7314150230716 | 1  | 311 |
| BE400P2413      | 7314150230723 | 1  | 311 |
| BE400P2414      | 7314150230730 | 1  | 311 |
| BE400P2415      | 7314150230747 | 1  | 311 |
| BE400P2416      | 7314150230754 | 1  | 311 |
| BE400P2417      | 7314150230761 | 1  | 312 |
| BE400P2418      | 7314150230778 | 1  | 312 |
| BE400P2419      | 7314150230785 | 1  | 312 |
| BE400P242       | 7314150230570 | 1  | 309 |
| BE400P2420      | 7314150237647 | 1  | 312 |
| BE400P243       | 7314150230587 | 1  | 310 |
| BE400P244       | 7314150230594 | 1  | 310 |
| BE401           | 7314150240593 | 1  | 309 |
| BE410           | 7314150205813 | 4  | 312 |
| BE4101          | 7314150230792 | 1  | 312 |
| BE5008          | 7314150239344 | 1  | 306 |
| BE5008-10       | 7314150239269 | 1  | 306 |
| BE5008-15       | 7314150239276 | 1  | 306 |
| BE5008-20       | 7314150239283 | 1  | 306 |
| BE5008-25       | 7314150239290 | 1  | 306 |





|              |               |    |     |
|--------------|---------------|----|-----|
| BE5008-27    | 7314150239306 | 1  | 306 |
| BE5008-30    | 7314150239313 | 1  | 306 |
| BE5008-40    | 7314150239320 | 1  | 306 |
| BE5008-45    | 7314150239337 | 1  | 306 |
| BE500P24     | 7314150169955 | 5  | 303 |
| BE500P2401   | 7314150209569 | 1  | 303 |
| BE500P2402   | 7314150209682 | 1  | 303 |
| BE500P2403   | 7314150209736 | 1  | 303 |
| BE500P2404   | 7314150209729 | 1  | 303 |
| BE500P2405   | 7314150209613 | 1  | 303 |
| BE500P2406   | 7314150209804 | 1  | 303 |
| BE500P2407   | 7314150209781 | 1  | 303 |
| BE500P2408   | 7314150209743 | 1  | 303 |
| BE500P2409   | 7314150209750 | 1  | 303 |
| BE500P2410   | 7314150209637 | 1  | 303 |
| BE500P2411   | 7314150209644 | 1  | 303 |
| BE500P2412   | 7314150209699 | 1  | 303 |
| BE500P2413   | 7314150209705 | 1  | 303 |
| BE500P2414   | 7314150209798 | 1  | 303 |
| BE500P2415   | 7314150209675 | 1  | 303 |
| BE500P2416   | 7314150209620 | 1  | 303 |
| BE500P2417   | 7314150209583 | 1  | 303 |
| BE500P2418   | 7314150209576 | 1  | 303 |
| BE500P2419   | 7314150209767 | 1  | 303 |
| BE500P2420   | 7314150209590 | 1  | 303 |
| BE500P2421   | 7314150209606 | 1  | 303 |
| BE500P2422   | 7314150209774 | 1  | 303 |
| BE500P2423   | 7314150209668 | 1  | 303 |
| BE500P2424   | 7314150209712 | 1  | 303 |
| BE501101     | 7314150274499 | 1  | 296 |
| BE501102     | 7314150274505 | 1  | 296 |
| BE501203     | 7314150274529 | 1  | 296 |
| BE501204     | 7314150274536 | 1  | 296 |
| BE502101     | 7314150274543 | 1  | 296 |
| BE502102     | 7314150274550 | 1  | 297 |
| BE502103     | 7314150274567 | 1  | 297 |
| BE502104     | 7314150384952 | 8  | 296 |
| BE502106     | 7314150403370 | 10 | 296 |
| BE502204     | 7314150274574 | 1  | 297 |
| BE5032       | 7314150189885 | 1  | 312 |
| BE503201     | 7314150274581 | 1  | 297 |
| BE5032H10EL  | 7314150220953 | 1  | 317 |
| BE5032H14    | 7314150220960 | 1  | 316 |
| BE5032M14    | 7314150220977 | 1  | 317 |
| BE5032SQ10   | 7314150220991 | 1  | 312 |
| BE5032SQ8    | 7314150220984 | 1  | 312 |
| BE5032T55EL  | 7314150220946 | 1  | 318 |
| BE504102     | 7314150274666 | 1  | 297 |
| BE504201     | 7314150274369 | 1  | 297 |
| BE5049       | 7314150169931 | 5  | 316 |
| BE504901     | 7314150184576 | 1  | 316 |
| BE504902     | 7314150184583 | 1  | 317 |
| BE5049H10    | 7314150184705 | 1  | 316 |
| BE5049H10L   | 7314150184712 | 1  | 317 |
| BE5049H12    | 7314150184729 | 1  | 316 |
| BE5049H12L   | 7314150184736 | 1  | 317 |
| BE5049H4     | 7314150184590 | 1  | 316 |
| BE5049H4L    | 7314150184606 | 1  | 317 |
| BE5049H5     | 7314150184613 | 1  | 316 |
| BE5049H5L    | 7314150184620 | 1  | 317 |
| BE5049H6     | 7314150184637 | 1  | 316 |
| BE5049H6L    | 7314150184651 | 1  | 317 |
| BE5049H7     | 7314150184668 | 1  | 316 |
| BE5049H7L    | 7314150184675 | 1  | 317 |
| BE5049H8     | 7314150184682 | 1  | 316 |
| BE5049H8L    | 7314150184699 | 1  | 317 |
| BE5049M10    | 7314150184804 | 1  | 317 |
| BE5049M10L   | 7314150184811 | 1  | 317 |
| BE5049M12    | 7314150184828 | 1  | 317 |
| BE5049M12L   | 7314150184835 | 1  | 317 |
| BE5049M5     | 7314150184743 | 1  | 317 |
| BE5049M5L    | 7314150184750 | 1  | 317 |
| BE5049M6     | 7314150184767 | 1  | 317 |
| BE5049M6L    | 7314150184774 | 1  | 317 |
| BE5049M8     | 7314150184781 | 1  | 317 |
| BE5049M8L    | 7314150184798 | 1  | 317 |
| BE5049T      | 7314150325474 | 1  | 318 |
| BE5049T20    | 7314150216048 | 1  | 317 |
| BE5049T20H   | 7314150184842 | 1  | 317 |
| BE5049T20HL  | 7314150184859 | 1  | 318 |
| BE5049T20L   | 7314150221011 | 1  | 318 |
| BE5049T25    | 7314150216055 | 1  | 317 |
| BE5049T25H   | 7314150184866 | 1  | 317 |
| BE5049T25HL  | 7314150184873 | 1  | 318 |
| BE5049T25L   | 7314150221028 | 1  | 318 |
| BE5049T27    | 7314150216062 | 1  | 317 |
| BE5049T27H   | 7314150184880 | 1  | 317 |
| BE5049T27HL  | 7314150184897 | 1  | 318 |
| BE5049T27L   | 7314150221035 | 1  | 318 |
| BE5049T30    | 7314150216079 | 1  | 317 |
| BE5049T30H   | 7314150184903 | 1  | 317 |
| BE5049T30HL  | 7314150184910 | 1  | 318 |
| BE5049T30HXL | 7314150184927 | 1  | 318 |
| BE5049T30L   | 7314150221042 | 1  | 318 |
| BE5049T40    | 7314150216086 | 1  | 317 |
| BE5049T40H   | 7314150184934 | 1  | 317 |



|              |               |   |     |
|--------------|---------------|---|-----|
| BE5049T40HL  | 7314150184941 | 1 | 318 |
| BE5049T40HXL | 7314150185092 | 1 | 318 |
| BE5049T40L   | 7314150221059 | 1 | 318 |
| BE5049T45    | 7314150216093 | 1 | 317 |
| BE5049T45H   | 7314150184958 | 1 | 317 |
| BE5049T45HL  | 7314150184965 | 1 | 318 |
| BE5049T45HXL | 7314150184972 | 1 | 318 |
| BE5049T45L   | 7314150216123 | 1 | 318 |
| BE5049T50    | 7314150216109 | 1 | 317 |
| BE5049T50H   | 7314150184989 | 1 | 317 |
| BE5049T50HL  | 7314150184996 | 1 | 318 |
| BE5049T50L   | 7314150221066 | 1 | 318 |
| BE5049T55    | 7314150216116 | 1 | 317 |
| BE5049T55H   | 7314150185009 | 1 | 317 |
| BE5049T55HL  | 7314150185016 | 1 | 318 |
| BE5049T55L   | 7314150221073 | 1 | 318 |
| BE5049T60    | 7314150221004 | 1 | 317 |
| BE5049T60H   | 7314150185023 | 1 | 317 |
| BE5049T60HL  | 7314150185030 | 1 | 318 |
| BE5049T70HL  | 7314150185047 | 1 | 317 |
| BE5049T80HL  | 7314150186532 | 1 | 318 |
| BE505101     | 7314150274598 | 1 | 298 |
| BE505102     | 7314150274604 | 1 | 298 |
| BE505203     | 7314150274611 | 1 | 298 |
| BE505204     | 7314150274628 | 1 | 298 |
| BE506101     | 7314150274376 | 1 | 298 |
| BE506102     | 7314150274635 | 1 | 298 |
| BE506103     | 7314150274642 | 1 | 299 |
| BE506204     | 7314150274659 | 1 | 299 |
| BE507101     | 7314150274673 | 1 | 299 |
| BE507102     | 7314150274680 | 1 | 299 |
| BE507203     | 7314150274697 | 1 | 299 |
| BE508101     | 7314150274765 | 1 | 300 |
| BE508202     | 7314150274772 | 1 | 300 |
| BE508203     | 7314150274703 | 1 | 300 |
| BE508204     | 7314150274710 | 1 | 300 |
| BE509101     | 7314150274727 | 1 | 300 |
| BE509102     | 7314150274734 | 1 | 300 |
| BE509103     | 7314150274383 | 1 | 301 |
| BE509104     | 7314150274741 | 1 | 301 |
| BE509205     | 7314150274390 | 1 | 301 |
| BE509206     | 7314150274406 | 1 | 301 |
| BE509207     | 7314150274758 | 1 | 301 |
| BE5100       | 7314150205646 | 1 | 303 |
| BE5101       | 7314150205721 | 1 | 317 |
| BE510101     | 7314150274420 | 1 | 301 |
| BE510102     | 7314150274437 | 1 | 301 |
| BE510125     | 7314150230877 | 1 | 312 |
| BE510127     | 7314150230884 | 1 | 312 |
| BE510130     | 7314150230891 | 1 | 312 |
| BE510140     | 7314150230907 | 1 | 313 |
| BE510145     | 7314150230914 | 1 | 313 |
| BE510150     | 7314150230921 | 1 | 313 |
| BE510155     | 7314150230938 | 1 | 313 |
| BE510160     | 7314150230945 | 1 | 313 |
| BE5102       | 7314150205738 | 1 | 308 |
| BE510203     | 7314150274789 | 1 | 302 |
| BE510210     | 7314150231003 | 1 | 308 |
| BE510211     | 7314150231010 | 1 | 308 |
| BE510212     | 7314150231027 | 1 | 308 |
| BE510213     | 7314150231034 | 1 | 308 |
| BE51025      | 7314150230952 | 1 | 308 |
| BE51026      | 7314150230969 | 1 | 308 |
| BE51027      | 7314150230976 | 1 | 308 |
| BE51028      | 7314150230983 | 1 | 308 |
| BE51029      | 7314150230990 | 1 | 308 |
| BE5103       | 7314150205745 | 1 | 308 |
| BE510304     | 7314150274444 | 1 | 302 |
| BE510310     | 7314150231072 | 1 | 308 |
| BE510312     | 7314150231089 | 1 | 308 |
| BE510314     | 7314150231096 | 1 | 308 |
| BE51035      | 7314150231041 | 1 | 308 |
| BE51036      | 7314150231058 | 1 | 308 |
| BE51038      | 7314150231065 | 1 | 308 |
| BE511011     | 7314150274451 | 1 | 302 |
| BE51102      | 7314150274468 | 1 | 302 |
| BE511203     | 7314150274796 | 1 | 302 |
| BE512201     | 7314150274475 | 1 | 304 |
| BE513201     | 7314150274802 | 1 | 302 |
| BE5150P27    | 7314150205790 | 1 | 313 |
| BE5150P271   | 7314150230808 | 1 | 313 |
| BE5150P272   | 7314150230815 | 1 | 313 |
| BE5150P273   | 7314150230822 | 1 | 313 |
| BE5200       | 7314150205905 | 1 | 317 |
| BE52001      | 7314150230433 | 1 | 317 |
| BE52002      | 7314150230440 | 1 | 317 |
| BE52003      | 7314150230447 | 1 | 317 |
| BE523106     | 7314150178391 | 1 | 302 |
| BE530001     | 7314150205912 | 1 | 317 |
| BE5350       | 7314150206049 | 5 | 305 |
| BE5350C1     | 7314150230389 | 1 | 305 |
| BE5350C2     | 7314150230396 | 1 | 305 |
| BE5350C3     | 7314150230402 | 1 | 305 |
| BE5350C4     | 7314150230419 | 1 | 305 |
| BE5350C5     | 7314150230426 | 1 | 305 |
| BE5400P      | 7314150245086 | 1 | 303 |



# BE5401D



|              |               |     |     |
|--------------|---------------|-----|-----|
| BE5401D      | 7314150245062 | 1   | 303 |
| BE5500       | 7314150403233 | 25  | 314 |
| BE550010     | 7314150432936 | 1   | 315 |
| BE550011     | 7314150432943 | 1   | 315 |
| BE550012     | 7314150432950 | 1   | 315 |
| BE550014     | 7314150432967 | 1   | 315 |
| BE550017     | 7314150432974 | 1   | 315 |
| BE550019     | 7314150432981 | 1   | 315 |
| BE61110      | 7314150167449 | 12  | 319 |
| BE61110-1    | 7314150167463 | 100 | 319 |
| BE61155      | 7314150167456 | 12  | 319 |
| BE61155-1    | 7314150167470 | 1   | 319 |
| BE62110      | 7314150403332 | 10  | 319 |
| BE62155      | 7314150403349 | 10  | 319 |
| BE6217       | 7314150169702 | 1   | 321 |
| BE621701     | 7314150232642 | 1   | 321 |
| BE621702     | 7314150232659 | 1   | 321 |
| BE621703     | 7314150232666 | 1   | 321 |
| BE621704     | 7314150232673 | 1   | 321 |
| BE621705     | 7314150232680 | 1   | 321 |
| BE621706     | 7314150232697 | 1   | 321 |
| BE621707     | 7314150232703 | 1   | 321 |
| BE621708     | 7314150232710 | 1   | 321 |
| BE621709     | 7314150232727 | 1   | 321 |
| BE621710     | 7314150232734 | 1   | 321 |
| BE621711     | 7314150232741 | 1   | 321 |
| BE621712     | 7314150232758 | 1   | 321 |
| BE621713     | 7314150232765 | 1   | 321 |
| BE621714     | 7314150232772 | 1   | 321 |
| BE621715     | 7314150232789 | 1   | 321 |
| BE621716     | 7314150232796 | 1   | 321 |
| BE621717     | 7314150232802 | 1   | 321 |
| BE630        | 7314150169580 | 3   | 320 |
| BE63010015F  | 7314150232598 | 25  | 320 |
| BE63010615F  | 7314150232604 | 1   | 320 |
| BE63010815F  | 7314150232611 | 1   | 320 |
| BE63010818F  | 7314150232628 | 1   | 320 |
| BE630246F    | 7314150169597 | 50  | 320 |
| BE6302712F   | 7314150412846 | 5   | 320 |
| BE630276F    | 7314150169603 | 50  | 320 |
| BE630326F    | 7314150169610 | 50  | 320 |
| BE630366F    | 7314150169627 | 100 | 320 |
| BE630386F    | 7314150169634 | 50  | 320 |
| BE63064514F1 | 7314150340095 | 1   | 320 |
| BE63064514F2 | 7314150340101 | 1   | 320 |
| BE6306514F   | 7314150232123 | 12  | 320 |
| BE630656714F | 7314150232130 | 12  | 320 |
| BE63066514F  | 7314150169641 | 25  | 320 |
| BE630666F    | 7314150232116 | 1   | 320 |
| BE6306814F   | 7314150232154 | 1   | 320 |
| BE6307314F   | 7314150232161 | 1   | 320 |
| BE6307414F   | 7314150370108 | 10  | 321 |
| BE6307415F   | 7314150232178 | 1   | 320 |
| BE630747615F | 7314150232307 | 12  | 320 |
| BE630757715F | 7314150232321 | 1   | 320 |
| BE6307612F   | 7314150232345 | 12  | 320 |
| BE6307614F   | 7314150232369 | 12  | 320 |
| BE6307630F   | 7314150232437 | 1   | 320 |
| BE630768F    | 7314150232468 | 1   | 320 |
| BE6307815F   | 7314150232475 | 12  | 320 |
| BE6308015F   | 7314150232482 | 1   | 320 |
| BE630808215F | 7314150232499 | 1   | 320 |
| BE6308616F   | 7314150232505 | 1   | 320 |
| BE6308618F   | 7314150232512 | 1   | 320 |
| BE6309015F   | 7314150232529 | 12  | 320 |
| BE6309210F   | 7314150232536 | 1   | 320 |
| BE6309315F   | 7314150232543 | 1   | 320 |
| BE6309336F   | 7314150232550 | 1   | 320 |
| BE6309345F   | 7314150232567 | 1   | 320 |
| BE6309515F   | 7314150232574 | 1   | 320 |
| BE6309618F   | 7314150232581 | 1   | 320 |
| BE64350      | 7314150169672 | 1   | 319 |
| BE64350CH    | 7314150169696 | 1   | 319 |
| BE64520      | 7314150169665 | 1   | 319 |
| BE64520CH    | 7314150169689 | 1   | 319 |
| BE65F65120   | 7314150169658 | 12  | 319 |
| BE65R106160  | 7314150170036 | 1   | 320 |
| BE65R65120   | 7314150170012 | 1   | 320 |
| BE65R80120   | 7314150170029 | 1   | 320 |
| BE66152A     | 7314150492534 | 6   | 319 |
| BE6701VAG    | 7314150333875 | 1   | 321 |
| BE68         | 7314150237876 | 1   | 321 |
| BE6810       | 7314150237869 | 1   | 321 |
| BE6810Z      | 7314150430765 | 12  | 321 |
| BE6FCP       | 7314150438907 | 30  | 315 |
| BE6OF108     | 7314150434572 | 50  | 319 |
| BE6OFW       | 7314150435784 | 5   | 319 |
| BE700        | 7314150206087 | 1   | 312 |
| BE700BP2     | 7314150206100 | 1   | 312 |
| BE700SP15    | 7314150206094 | 1   | 312 |
| BE74-55100   | 7314150169733 | 1   | 309 |
| BE74-57125   | 7314150169511 | 1   | 309 |
| BE74-57125L  | 7314150169535 | 1   | 309 |
| BE74-80120   | 7314150169740 | 1   | 309 |
| BE74-90175   | 7314150169528 | 1   | 309 |
| BE76101      | 7314150240005 | 1   | 305 |



|               |               |    |     |
|---------------|---------------|----|-----|
| BE762         | 7314150384983 | 12 | 305 |
| BE800P12      | 7314150205677 | 1  | 313 |
| BELMS120BDL   | 7314150340323 | 8  | 337 |
| BELP1224      | 7314150177882 | 1  | 340 |
| BELS12        | 7314150170579 | 1  | 340 |
| BELT1213A     | 7314150493104 | 20 | 339 |
| BELT127       | 7314150177899 | 1  | 339 |
| BELT2415A     | 7314150493098 | 20 | 340 |
| BELT247N      | 7314150170586 | 1  | 340 |
| BELT247S      | 7314150170593 | 1  | 340 |
| BELTKEY       | 7314150177875 | 1  | 339 |
| BELTRP16      | 7314150169917 | 1  | 340 |
| BELTRP1601    | 7314150231935 | 1  | 340 |
| BELTRP1602    | 7314150231942 | 1  | 340 |
| BELTRP1603    | 7314150231959 | 1  | 340 |
| BELTRP1604    | 7314150231966 | 1  | 340 |
| BELTRP1605    | 7314150231973 | 1  | 340 |
| BELTRP1606    | 7314150231980 | 1  | 340 |
| BELTRP1607    | 7314150231997 | 1  | 340 |
| BELTRP1608    | 7314150232000 | 1  | 340 |
| BELTRP1609    | 7314150232017 | 1  | 340 |
| BELTRP1610    | 7314150232024 | 1  | 340 |
| BELTRP1611    | 7314150232031 | 1  | 340 |
| BELTRP1612    | 7314150232048 | 1  | 340 |
| BELTRP1613    | 7314150232062 | 1  | 340 |
| BELTRP1614    | 7314150232079 | 1  | 340 |
| BELTRP1615    | 7314150232086 | 1  | 340 |
| BELTRP1616    | 7314150232093 | 1  | 340 |
| BFRL11        | 7314150306534 | 1  | 358 |
| BGIS125       | 7314150416431 | 20 | 340 |
| BH110000A-02  | 7314150273669 | 1  | 351 |
| BH110000A-04  | 7314150273683 | 1  | 351 |
| BH110000A-EXT | 7314150291946 | 1  | 351 |
| BH110000B     | 7314150516414 | 1  | 351 |
| BH11500       | 7314150178797 | 1  | 350 |
| BH11500-01    | 7314150182220 | 1  | 355 |
| BH11500-02    | 7314150182237 | 1  | 351 |
| BH11500-04    | 7314150182275 | 1  | 351 |
| BH12000       | 7314150178803 | 1  | 350 |
| BH13000       | 7314150178810 | 1  | 350 |
| BH13000-02    | 7314150182244 | 1  | 351 |
| BH13000L      | 7314150301980 | 1  | 351 |
| BH13000L-01   | 7314150301997 | 1  | 355 |
| BH13000QA     | 7314150403295 | 1  | 351 |
| BH15000A-01   | 7314150273515 | 1  | 355 |
| BH15000A-02   | 7314150273522 | 1  | 351 |
| BH15000A-04   | 7314150273546 | 1  | 351 |
| BH15000A-EXT  | 7314150291939 | 1  | 351 |
| BH15000B      | 7314150516407 | 1  | 351 |
| BH1A1500-04   | 7314150265299 | 1  | 355 |
| BH1A1500A     | 7314150460946 | 1  | 350 |
| BH1A1500A-05  | 7314150477302 | 40 | 351 |
| BH1A2500-03   | 7314150226856 | 1  | 351 |
| BH1A2500-04   | 7314150226863 | 1  | 355 |
| BH1A2500A     | 7314150460953 | 1  | 350 |
| BH1CB1000     | 7314150243204 | 1  | 351 |
| BH1CD680      | 7314150330379 | 1  | 354 |
| BH1CD680ST    | 7314150330386 | 1  | 354 |
| BH1EU3000     | 7314150245000 | 1  | 350 |
| BH1EU3000-01  | 7314150250004 | 1  | 351 |
| BH1EU3000-03  | 7314150249893 | 1  | 351 |
| BH1EU3000-08  | 7314150249947 | 1  | 355 |
| BH1M1000      | 7314150237845 | 1  | 350 |
| BH1S45        | 7314150292295 | 1  | 351 |
| BH1S45-01     | 7314150311194 | 1  | 355 |
| BH1S45-03     | 7314150311217 | 1  | 351 |
| BH230         | 7314150264070 | 1  | 352 |
| BH23015       | 7314150178759 | 1  | 351 |
| BH23015C      | 7314150178742 | 1  | 352 |
| BH2402010     | 7314150178766 | 1  | 352 |
| BH2604020     | 7314150178773 | 1  | 353 |
| BH28050       | 7314150472222 | 1  | 353 |
| BH2AC1        | 7314150213474 | 1  | 353 |
| BH2AC2        | 7314150213481 | 1  | 353 |
| BH33000       | 7314150178674 | 1  | 353 |
| BH36000       | 7314150178681 | 1  | 353 |
| BH3A10000     | 7314150234660 | 1  | 353 |
| BH3A3000      | 7314150234646 | 1  | 353 |
| BH3A5000      | 7314150234653 | 1  | 353 |
| BH3AL2500     | 7314150302420 | 1  | 353 |
| BH3HD12000    | 7314150170500 | 1  | 353 |
| BH3HD16000    | 7314150170524 | 1  | 354 |
| BH3HD20000A   | 7314150337668 | 1  | 354 |
| BH3HD8000     | 7314150170494 | 2  | 353 |
| BH3SQ15000    | 7314150234684 | 2  | 353 |
| BH3SQ7000     | 7314150234677 | 2  | 353 |
| BH410         | 7314150178711 | 1  | 350 |
| BH415         | 7314150178728 | 2  | 350 |
| BH42          | 7314150178698 | 1  | 350 |
| BH420         | 7314150178735 | 1  | 350 |
| BH430         | 7314150178780 | 2  | 350 |
| BH45          | 7314150178704 | 1  | 350 |
| BH4HP50       | 7314150477081 | 1  | 350 |
| BH4S12        | 7314150237920 | 3  | 349 |
| BH4S2         | 7314150237883 | 6  | 349 |
| BH4S20        | 7314150237937 | 1  | 349 |





|               |               |    |     |
|---------------|---------------|----|-----|
| BH4S4         | 7314150237890 | 6  | 349 |
| BH4S50        | 7314150476879 | 1  | 349 |
| BH4S6         | 7314150237906 | 4  | 349 |
| BH4S8         | 7314150237913 | 4  | 349 |
| BH5DP1000QA   | 7314150270224 | 1  | 354 |
| BH5SP500QA    | 7314150270217 | 1  | 354 |
| BH5US1000     | 7314150243174 | 1  | 354 |
| BH6AC1-680A   | 7314150433544 | 1  | 355 |
| BH6FC1000     | 7314150178650 | 1  | 355 |
| BH6FC2000     | 7314150234639 | 1  | 355 |
| BH6PC600      | 7314150234622 | 1  | 355 |
| BH7100A       | 7314150345908 | 1  | 341 |
| BH7100SG      | 7314150299782 | 1  | 342 |
| BH715         | 7314150237555 | 1  | 341 |
| BH715-13      | 7314150239191 | 1  | 341 |
| BH720         | 7314150235650 | 1  | 341 |
| BH720-22      | 7314150236961 | 1  | 341 |
| BH720SG       | 7314150238477 | 1  | 342 |
| BH730         | 7314150235667 | 1  | 341 |
| BH730SG       | 7314150238484 | 1  | 342 |
| BH750         | 7314150235674 | 1  | 341 |
| BH750SG       | 7314150238491 | 1  | 342 |
| BH7PS30       | 7314150474882 | 2  | 341 |
| BH8AC1-500    | 7314150170463 | 1  | 313 |
| BH8AC2-500    | 7314150412532 | 1  | 313 |
| BH8AC3-1500A  | 7314150516391 | 1  | 354 |
| BH8AC3-600    | 7314150351893 | 1  | 354 |
| BH8BC1        | 7314150242276 | 1  | 349 |
| BH8BC2        | 7314150242283 | 1  | 349 |
| BH8BC3        | 7314150242290 | 10 | 349 |
| BH8BC4        | 7314150242306 | 6  | 349 |
| BH8BC5        | 7314150242313 | 6  | 349 |
| BH8PR10000    | 7314150178957 | 1  | 349 |
| BH8PR4000     | 7314150178940 | 1  | 349 |
| BH9BJ22SLH    | 7314150246946 | 1  | 352 |
| BH9BJ22SSH    | 7314150247462 | 1  | 352 |
| BH9BJ23SLH    | 7314150246953 | 1  | 352 |
| BH9BJ23SSH    | 7314150246960 | 1  | 352 |
| BH9BJ260      | 7314150247509 | 1  | 352 |
| BH9BJ280      | 7314150247516 | 1  | 352 |
| BHVG15-250    | 7314150403745 | 1  | 355 |
| BHVIS06100    | 7314150167753 | 1  | 332 |
| BHVIS06105    | 7314150167760 | 1  | 332 |
| BHVIS0670     | 7314150167692 | 1  | 332 |
| BHVIS0677     | 7314150167708 | 1  | 332 |
| BHVIS0680     | 7314150167715 | 1  | 332 |
| BHVIS0685     | 7314150167722 | 1  | 332 |
| BHVIS0690     | 7314150167739 | 1  | 332 |
| BHVIS0695     | 7314150167746 | 1  | 332 |
| BHVIS08100    | 7314150165711 | 1  | 332 |
| BHVIS08115    | 7314150165728 | 1  | 332 |
| BHVIS0895     | 7314150165704 | 1  | 332 |
| BHVIS109BPW12 | 7314150165759 | 1  | 332 |
| BHVIS111BPW12 | 7314150165735 | 1  | 332 |
| BHVIS120BPW16 | 7314150165742 | 1  | 332 |
| BHVIS1265     | 7314150167685 | 1  | 332 |
| BHVIS80BPW12  | 7314150165766 | 1  | 332 |
| BHVIS95BPW9   | 7314150243334 | 1  | 332 |
| BKE850901N    | 7314150449705 | 10 | 229 |
| BLBT100       | 7314150179015 | 1  | 343 |
| BLBT100AC1    | 7314150179022 | 1  | 343 |
| BLCR230FR     | 7314150247356 | 1  | 358 |
| BLCR230SC     | 7314150247349 | 1  | 358 |
| BLCR24VCL     | 7314150247370 | 1  | 358 |
| BLCR24VLL     | 7314150247387 | 1  | 358 |
| BLCR400E      | 7314150247363 | 1  | 358 |
| BLCRSC1       | 7314150247530 | 1  | 358 |
| BLCRSC2       | 7314150247547 | 1  | 358 |
| BLE300        | 7314150227648 | 1  | 343 |
| BLE301        | 7314150227662 | 1  | 343 |
| BLE302        | 7314150227679 | 1  | 343 |
| BLE304        | 7314150249572 | 1  | 343 |
| BLE305        | 7314150339341 | 1  | 342 |
| BLEMAT1       | 7314150477678 | 1  | 342 |
| BLEMAT1BT     | 7314150477685 | 1  | 342 |
| BLT550        | 7314150243556 | 10 | 304 |
| BLTFC1        | 7314150246434 | 20 | 358 |
| BLTS10        | 7314150246427 | 20 | 358 |
| BLTS7P        | 7314150246410 | 58 | 358 |
| BMD150        | 7314150242238 | 1  | 342 |
| BMMTRMS1      | 7314150274024 | 1  | 339 |
| BMR240        | 7314150242245 | 1  | 342 |
| BMVAT1000     | 7314150488360 | 50 | 339 |
| BOD101        | 7314150205967 | 1  | 321 |
| BOD1016       | 7314150169979 | 1  | 323 |
| BOD101NWS     | 7314150269099 | 1  | 321 |
| BOD101T       | 7314150269150 | 1  | 324 |
| BOD102        | 7314150205974 | 1  | 321 |
| BOD102NWS     | 7314150269105 | 1  | 321 |
| BOD102T       | 7314150269167 | 1  | 324 |
| BOD103        | 7314150205981 | 1  | 321 |
| BOD103NWS     | 7314150269112 | 1  | 321 |
| BOD103T       | 7314150269174 | 1  | 324 |
| BOD104        | 7314150205998 | 1  | 321 |
| BOD104NWS     | 7314150269129 | 1  | 321 |
| BOD104T       | 7314150269181 | 1  | 324 |



|               |               |    |     |
|---------------|---------------|----|-----|
| BOD105        | 7314150206001 | 1  | 321 |
| BOD105NWS     | 7314150269136 | 1  | 321 |
| BOD105T       | 7314150269198 | 1  | 324 |
| BOD106        | 7314150206018 | 1  | 321 |
| BOD106NWS     | 7314150269143 | 1  | 321 |
| BOD106T       | 7314150269204 | 1  | 324 |
| BOD10P64      | 7314150205950 | 8  | 321 |
| BOD2008       | 7314150169986 | 1  | 323 |
| BOD2FS        | 7314150351879 | 20 | 324 |
| BOD301200     | 7314150169993 | 1  | 323 |
| BOD4200       | 7314150169436 | 1  | 323 |
| BOD4500       | 7314150169443 | 1  | 323 |
| BOD54-1       | 7314150239467 | 1  | 324 |
| BOD54-2       | 7314150239474 | 1  | 324 |
| BOD54-3       | 7314150239481 | 1  | 324 |
| BOD5400       | 7314150169450 | 1  | 324 |
| BOD5450       | 7314150169474 | 1  | 324 |
| BOD5HD400     | 7314150169467 | 1  | 324 |
| BOD60         | 7314150169481 | 1  | 324 |
| BOD6080P12    | 7314150235407 | 1  | 322 |
| BOD6080P12-01 | 7314150235438 | 1  | 322 |
| BOD6080P12-02 | 7314150235445 | 1  | 322 |
| BOD6080P12-03 | 7314150235452 | 1  | 322 |
| BOD6080P12-04 | 7314150235469 | 1  | 322 |
| BOD6080P12-05 | 7314150235476 | 1  | 323 |
| BOD6080P12-06 | 7314150235490 | 1  | 323 |
| BOD6080P12-07 | 7314150235506 | 1  | 323 |
| BOD6080P12-08 | 7314150235513 | 1  | 323 |
| BOD6080P12-09 | 7314150235520 | 1  | 323 |
| BOD6080P12-10 | 7314150235537 | 1  | 323 |
| BOD6080P12-11 | 7314150235544 | 1  | 323 |
| BOD70         | 7314150169498 | 1  | 324 |
| BOD8901       | 7314150169016 | 1  | 322 |
| BOD8901AC1    | 7314150178490 | 1  | 322 |
| BOD8902       | 7314150169023 | 1  | 322 |
| BOD8903A      | 7314150265374 | 1  | 322 |
| BOM10X        | 7314150540549 | 10 | 361 |
| BP-40         | 7314150453085 | 1  | 573 |
| BP-40-95      | 7314150487097 | 12 | 573 |
| BP110         | 7314150135011 | 1  | 279 |
| BP111E        | 7314150235872 | 12 | 279 |
| BP115         | 7314150134991 | 1  | 277 |
| BP117         | 7314150184309 | 1  | 277 |
| BP117EH       | 7314150184316 | 1  | 279 |
| BP118         | 7314150235834 | 1  | 277 |
| BP125A        | 7314150427291 | 6  | 285 |
| BP127         | 7314150137565 | 1  | 279 |
| BP12718       | 8414909179002 | 1  | 280 |
| BP127P        | 7314150427277 | 1  | 281 |
| BP204         | 7314150184286 | 1  | 279 |
| BP20410320    | 7314150185948 | 1  | 281 |
| BP20410800    | 7314150185955 | 1  | 281 |
| BP20425180    | 7314150185924 | 1  | 281 |
| BP20425220    | 7314150185931 | 1  | 281 |
| BP204K        | 7314150184293 | 1  | 281 |
| BP204PAD      | 7314150185917 | 1  | 281 |
| BP212         | 7314150134601 | 1  | 281 |
| BP215A        | 7314150341849 | 10 | 285 |
| BP218         | 7314150170272 | 1  | 286 |
| BP219         | 7314150235889 | 1  | 286 |
| BP219L        | 7314150235896 | 1  | 286 |
| BP219V        | 7314150307197 | 1  | 286 |
| BP219XL       | 7314150427192 | 10 | 286 |
| BP222         | 7314150137572 | 1  | 281 |
| BP233         | 7314150134748 | 1  | 283 |
| BP254         | 7314150137633 | 1  | 286 |
| BP255         | 7314150137640 | 1  | 287 |
| BP255T        | 7314150427307 | 1  | 287 |
| BP255T-1      | 7314150427314 | 1  | 287 |
| BP277K        | 7314150427284 | 8  | 285 |
| BP420M        | 7314150134618 | 1  | 278 |
| BP421M        | 7314150134625 | 1  | 278 |
| BP422M        | 7314150134632 | 1  | 278 |
| BP423M        | 7314150134649 | 1  | 278 |
| BP424M        | 7314150134656 | 1  | 278 |
| BP430M        | 7314150134663 | 1  | 278 |
| BP431M        | 7314150134670 | 1  | 278 |
| BP432M        | 7314150134687 | 1  | 279 |
| BP433M        | 7314150134694 | 1  | 279 |
| BP434M        | 7314150135837 | 1  | 279 |
| BP500         | 7314150137992 | 1  | 286 |
| BP51137       | 7314150134724 | 1  | 281 |
| BP601         | 7314150134526 | 1  | 281 |
| BP60102       | 7314150426669 | 1  | 281 |
| BP610         | 7314150134595 | 1  | 282 |
| BP700         | 7314150134458 | 20 | 277 |
| BP704         | 7314150427130 | 1  | 274 |
| BP721         | 7314150427185 | 1  | 277 |
| BP799         | 7314150134502 | 1  | 285 |
| BP79912       | 7314150134717 | 1  | 285 |
| BP809         | 7314150235841 | 1  | 282 |
| BP80950       | 7314150275564 | 1  | 282 |
| BP810         | 7314150235858 | 1  | 282 |
| BP811         | 7314150235865 | 1  | 284 |
| BP814         | 7314150184262 | 10 | 274 |
| BP814A        | 7314150304349 | 10 | 274 |





|            |               |    |     |
|------------|---------------|----|-----|
| BP815      | 7314150134311 | 1  | 274 |
| BP815K1    | 7314150181957 | 1  | 274 |
| BP815K2    | 7314150181964 | 1  | 274 |
| BP817      | 7314150134106 | 1  | 275 |
| BP820      | 7314150134465 | 1  | 277 |
| BP821      | 7314150134472 | 1  | 277 |
| BP822      | 7314150134984 | 1  | 278 |
| BP822E     | 7314150184279 | 10 | 278 |
| BP823      | 7314150135004 | 1  | 279 |
| BP824      | 7314150134489 | 1  | 283 |
| BP825      | 7314150134496 | 1  | 282 |
| BP826      | 7314150137459 | 1  | 283 |
| BP827      | 7314150137442 | 1  | 283 |
| BP828      | 7314150427260 | 1  | 283 |
| BP830CISB  | 7314150439799 | 1  | 280 |
| BP830ESB   | 7314150439751 | 1  | 280 |
| BP830EWB   | 7314150439768 | 1  | 280 |
| BP830K     | 7314150427208 | 4  | 280 |
| BP830MISB  | 7314150439782 | 1  | 280 |
| BP830SBA   | 7314150439805 | 1  | 280 |
| BP830SSB   | 7314150439775 | 1  | 280 |
| BP830SW    | 7314150439744 | 1  | 280 |
| BP901      | 7314150336012 | 1  | 276 |
| BP901L     | 7314150336029 | 1  | 276 |
| BP905L     | 7314150336234 | 2  | 276 |
| BP905P     | 7314150336210 | 2  | 276 |
| BP905S     | 7314150336227 | 2  | 276 |
| BP909NE    | 7314150187980 | 1  | 285 |
| BP909NF    | 7314150187973 | 1  | 285 |
| BP909TE    | 7314150187942 | 1  | 284 |
| BP909TF    | 7314150187911 | 1  | 284 |
| BP909TH    | 7314150187959 | 1  | 284 |
| BP909TSP   | 7314150187966 | 1  | 285 |
| BP909TTP   | 7314150187935 | 1  | 284 |
| BP909TWF   | 7314150187928 | 1  | 284 |
| BP910      | 7314150427246 | 5  | 284 |
| BP91BL     | 7314150192779 | 1  | 277 |
| BP91BS     | 7314150192786 | 1  | 277 |
| BPA823     | 7314150427161 | 1  | 282 |
| BPGG3515   | 7314150134823 | 1  | 283 |
| BPGG3525A  | 7314150134830 | 1  | 283 |
| BPGG3525B  | 7314150134847 | 1  | 283 |
| BPGG5725   | 7314150134861 | 1  | 284 |
| BPGG9057   | 7314150134878 | 1  | 284 |
| BPPBK30    | 7314150134854 | 1  | 283 |
| BPBL00900  | 7314150358335 | 5  | 344 |
| BPBL30900  | 7314150360451 | 5  | 344 |
| BPBL70600  | 7314150360468 | 5  | 344 |
| BPBL90600  | 7314150358366 | 5  | 344 |
| BPBLS4     | 7314150360475 | 2  | 344 |
| BPBSC156   | 7314150134816 | 1  | 283 |
| BPBU18     | 7314150134755 | 1  | 284 |
| BPBU24     | 7314150134762 | 1  | 284 |
| BPBU36     | 7314150134779 | 1  | 284 |
| BPBU60     | 7314150134786 | 1  | 284 |
| BPBU90     | 7314150134793 | 1  | 284 |
| BPC813     | 7314150296408 | 10 | 274 |
| BPC813K1   | 7314150331253 | 1  | 274 |
| BPC814     | 7314150296392 | 10 | 275 |
| BPC815     | 7314150296385 | 1  | 275 |
| BPC815K1   | 7314150331208 | 1  | 275 |
| BPC815K2   | 7314150331215 | 1  | 275 |
| BPC815K3   | 7314150331222 | 1  | 275 |
| BPC815K4   | 7314150331239 | 1  | 275 |
| BPC815K6   | 7314150331284 | 1  | 275 |
| BPC816     | 7314150296415 | 10 | 274 |
| BPC817     | 7314150296422 | 4  | 275 |
| BPC817K1   | 7314150331260 | 1  | 276 |
| BPC817K2   | 7314150331277 | 1  | 276 |
| BPC823     | 7314150427147 | 1  | 282 |
| BPC825     | 7314150427154 | 1  | 282 |
| BPCVB1     | 7314150384792 | 6  | 334 |
| BPG824     | 7314150427253 | 10 | 283 |
| BPH1010A   | 7314150330010 | 1  | 287 |
| BPH1010B   | 7314150341757 | 1  | 287 |
| BPH1310A   | 7314150330003 | 1  | 287 |
| BPHRC1015  | 7314150247400 | 1  | 287 |
| BPHRC1020  | 7314150247417 | 1  | 287 |
| BPHRC1316  | 7314150247455 | 1  | 287 |
| BPHRC815   | 7314150247394 | 1  | 287 |
| BPHRO1315  | 7314150247431 | 1  | 288 |
| BPHRSC     | 7314150247448 | 1  | 287 |
| BPHVLP01   | 7314150138937 | 1  | 285 |
| BPHVLP0112 | 7314150165872 | 1  | 286 |
| BPHVLP0114 | 7314150165889 | 1  | 286 |
| BPHVLP0117 | 7314150165896 | 1  | 286 |
| BPHVLP0120 | 7314150165902 | 1  | 286 |
| BPM917BOOT | 7314150281664 | 1  | 276 |
| BPM91MK1   | 7314150186938 | 1  | 276 |
| BPM91MK2   | 7314150186945 | 1  | 276 |
| BPN010     | 7314150219728 | 1  | 286 |
| BPN21201   | 7314150134731 | 1  | 282 |
| BPN22201   | 7314150138074 | 1  | 282 |
| BPN251     | 7314150137589 | 1  | 287 |
| BPQC15     | 7314150360673 | 12 | 314 |
| BPR821     | 7314150427178 | 1  | 277 |



|                   |               |    |     |
|-------------------|---------------|----|-----|
| BPSJ              | 7314150427239 | 1  | 288 |
| BPSJL             | 7314150439812 | 1  | 288 |
| BS1000            | 7314150170081 | 1  | 336 |
| BS100001          | 7314150232819 | 1  | 336 |
| BS100002          | 7314150232826 | 1  | 336 |
| BS100003          | 7314150232833 | 1  | 336 |
| BS100004          | 7314150232840 | 1  | 336 |
| BS100005          | 7314150232857 | 1  | 336 |
| BS100006          | 7314150232864 | 1  | 336 |
| BS100007          | 7314150232871 | 1  | 336 |
| BS100008          | 7314150232888 | 1  | 336 |
| BS100009          | 7314150232895 | 1  | 336 |
| BS100010          | 7314150232901 | 1  | 336 |
| BS100011          | 7314150232918 | 1  | 336 |
| BS100012          | 7314150232925 | 1  | 336 |
| BS100013          | 7314150232932 | 1  | 336 |
| BS100014          | 7314150232949 | 1  | 336 |
| BS100015          | 7314150232956 | 1  | 336 |
| BS100016          | 7314150232963 | 1  | 336 |
| BS100017          | 7314150232970 | 1  | 336 |
| BS100018          | 7314150232987 | 1  | 336 |
| BS100019          | 7314150232994 | 1  | 336 |
| BS100020          | 7314150233007 | 1  | 336 |
| BS100021          | 7314150233014 | 1  | 336 |
| BS100022          | 7314150233021 | 1  | 336 |
| BS100023          | 7314150233038 | 1  | 336 |
| BS100024          | 7314150233045 | 1  | 336 |
| BS100025          | 7314150233052 | 1  | 336 |
| BS100026          | 7314150233069 | 1  | 336 |
| BS100027          | 7314150233076 | 1  | 337 |
| BS100028          | 7314150233083 | 1  | 337 |
| BS100029          | 7314150233090 | 1  | 337 |
| BS100030          | 7314150233106 | 1  | 337 |
| BS100031          | 7314150233113 | 1  | 337 |
| BS100032          | 7314150233120 | 1  | 337 |
| BS100033          | 7314150233137 | 1  | 337 |
| BS100034          | 7314150233144 | 1  | 337 |
| BS100035          | 7314150233151 | 1  | 337 |
| BS100036          | 7314150233168 | 1  | 337 |
| BS100037          | 7314150233175 | 1  | 337 |
| BS100038          | 7314150233182 | 1  | 337 |
| BS100039          | 7314150233199 | 1  | 337 |
| BS100PSA1         | 7314150249282 | 1  | 335 |
| BS10AC2           | 7314150182343 | 1  | 336 |
| BS15              | 7314150206117 | 1  | 336 |
| BS15125           | 7314150231775 | 1  | 336 |
| BS15125C          | 7314150231812 | 1  | 336 |
| BS15160           | 7314150231782 | 1  | 336 |
| BS15160C          | 7314150231829 | 1  | 336 |
| BS15212           | 7314150231799 | 1  | 336 |
| BS15212C          | 7314150231836 | 1  | 336 |
| BS1550            | 7314150231805 | 1  | 336 |
| BS25              | 7314150416103 | 1  | 336 |
| BS30AC1           | 7314150383504 | 1  | 336 |
| BS30PG            | 7314150436644 | 1  | 336 |
| BS40VAG           | 7314150430642 | 20 | 334 |
| BS45BMW           | 7314150430659 | 20 | 334 |
| BS52              | 7314150329212 | 1  | 334 |
| BS5228341         | 7314150329229 | 1  | 333 |
| BS5234401         | 7314150329236 | 1  | 333 |
| BS5239451         | 7314150329243 | 1  | 333 |
| BS54              | 7314150243341 | 1  | 334 |
| BS56              | 7314150430826 | 6  | 334 |
| BS618             | 7314150242368 | 1  | 335 |
| BS623             | 7314150242375 | 1  | 335 |
| BSSHE3            | 7314150251858 | 1  | 333 |
| BT10P3            | 7314150205639 | 1  | 344 |
| BT10P325          | 7314150231706 | 40 | 344 |
| BT10P330          | 7314150231713 | 1  | 344 |
| BT10P338          | 7314150231720 | 1  | 344 |
| BT15P5            | 7314150205837 | 1  | 332 |
| BT15P524          | 7314150231737 | 1  | 332 |
| BT15P530          | 7314150231744 | 1  | 332 |
| BT15P532          | 7314150231751 | 1  | 332 |
| BT15P536          | 7314150342129 | 1  | 332 |
| BT20P26           | 7314150205820 | 1  | 335 |
| BT20P49           | 7314150385041 | 1  | 335 |
| BTL-3-13          | 7314150333349 | 12 | 538 |
| BTL-6-13          | 7314150333356 | 12 | 538 |
| BTR-3-13          | 7314150333332 | 12 | 538 |
| BTR-6-13          | 7314150333363 | 12 | 538 |
| BUC100            | 7314150169962 | 1  | 319 |
| BUC110            | 7314150206025 | 1  | 319 |
| BUC50             | 7314150182329 | 1  | 318 |
| BUCKET - 1446-CS  | 7314150534555 | 1  | 585 |
| BUCKET - EMPTY    | 7314150511037 | 6  | 585 |
| BUCKET 1446       | 7314150436446 | 75 | 585 |
| BUCKET-1446-FLOAT | 7314150539550 | 1  | 585 |
| BUCPE             | 7314150243259 | 1  | 318 |
| BUCPE3SDH         | 7314153024183 | 1  | 318 |
| BUCPE3SH          | 7314150243471 | 1  | 318 |
| BUCPEF            | 7314150244942 | 1  | 318 |
| BUCPEF1           | 7314150245116 | 1  | 318 |
| BWB14             | 7314150170166 | 2  | 334 |
| BWB1418S4         | 7314150365593 | 6  | 342 |
| BWB1922S4         | 7314150365609 | 6  | 342 |



|              |                |     |     |
|--------------|----------------|-----|-----|
| BWBB         | 7314150407828  | 200 | 330 |
| BWC1         | 7314150365586  | 25  | 331 |
| BWHEHS       | 7314150251841  | 1   | 333 |
| BWHEP        | 7314150251834  | 1   | 333 |
| BWHEPS       | 7314150264087  | 1   | 332 |
| BWHEPSH8     | 7314150264889  | 1   | 333 |
| BWHEPSSH8    | 7314150264896  | 1   | 332 |
| BWHPJ12      | 7314150403257  | 4   | 335 |
| BWHTRS12     | 7314150384808  | 15  | 330 |
| BWMSP15      | 7314150239740  | 1   | 369 |
| BWMSP1501    | 7314150239757  | 1   | 369 |
| BWMSP1502    | 7314150239764  | 1   | 369 |
| BWMSP1503    | 7314150239771  | 1   | 369 |
| BWMSP1504    | 7314150239788  | 1   | 369 |
| BWMSP1505    | 7314150239795  | 1   | 369 |
| BWMSP1506    | 7314150239801  | 1   | 369 |
| BWMSP1507    | 73141503024176 | 1   | 369 |
| BWMSP1508    | 7314150239818  | 1   | 369 |
| BWMSP1509    | 7314150239825  | 1   | 369 |
| BWMSP1510    | 7314150239832  | 1   | 369 |
| BWMSP1511    | 7314150239849  | 1   | 369 |
| BWMSP1512    | 7314150239856  | 1   | 369 |
| BWMSP1513    | 7314150239863  | 1   | 369 |
| BWMSP1514    | 7314150239870  | 1   | 369 |
| BWMSP1515    | 7314150239887  | 1   | 369 |
| BWP150       | 7314150170159  | 1   | 331 |
| BWSH5        | 7314150251810  | 2   | 333 |
| BWSH51       | 7314150251827  | 1   | 333 |
| BWSH8        | 7314150255191  | 1   | 333 |
| BWSHK21      | 7314150403271  | 25  | 329 |
| BWSMB15      | 7314150365074  | 25  | 328 |
| BWSMB17      | 7314150329656  | 1   | 329 |
| BWSS12P3     | 7314150170128  | 20  | 328 |
| BWSS12P317   | 7314150203451  | 1   | 328 |
| BWSS12P317L  | 7314150330065  | 1   | 329 |
| BWSS12P319   | 7314150203468  | 1   | 328 |
| BWSS12P319L  | 7314150330072  | 1   | 329 |
| BWSS12P321   | 7314150203475  | 1   | 328 |
| BWSS12P321L  | 7314150330089  | 1   | 329 |
| BWSS12P3L    | 7314150330096  | 1   | 329 |
| BWSS12P5     | 7314150170135  | 1   | 328 |
| BWSS12P522   | 7314150203482  | 1   | 328 |
| BWSS12P524   | 7314150203499  | 1   | 328 |
| BWTB12P100   | 7314150329830  | 1   | 330 |
| BWTB12P110   | 7314150329847  | 1   | 330 |
| BWTB12P120   | 7314150329854  | 1   | 330 |
| BWTB12P135   | 7314150329861  | 1   | 330 |
| BWTB12P150   | 7314150329878  | 1   | 330 |
| BWTB12P160   | 7314150329885  | 1   | 330 |
| BWTB12P175   | 7314150329892  | 1   | 330 |
| BWTB12P190   | 7314150329908  | 1   | 330 |
| BWTB12P200   | 7314150329915  | 1   | 330 |
| BWTB12P5     | 7314150329991  | 1   | 330 |
| BWTB12P90    | 7314150329823  | 1   | 330 |
| BWTDG1       | 7314150403400  | 50  | 331 |
| BWTPG1       | 7314150351886  | 10  | 331 |
| BWTPMSS4C    | 7314150347100  | 25  | 332 |
| BWTPMSS9     | 7314150347124  | 8   | 331 |
| BWTSP16      | 7314150170296  | 1   | 330 |
| BWTSP1608    | 7314150203284  | 1   | 330 |
| BWTSP1610    | 7314150203291  | 1   | 330 |
| BWTSP1611    | 7314150203307  | 1   | 330 |
| BWTSP1612    | 7314150203314  | 1   | 330 |
| BWTSP1613    | 7314150203321  | 1   | 330 |
| BWTSP1614    | 7314150203338  | 1   | 330 |
| BWTSP1616    | 7314150203345  | 1   | 330 |
| BWTSP1617    | 7314150203352  | 1   | 330 |
| BWTSP1618    | 7314150203369  | 1   | 330 |
| BWTSP1619    | 7314150203376  | 1   | 330 |
| BWTSP1621    | 7314150203383  | 1   | 330 |
| BWTSP1622    | 7314150203390  | 1   | 330 |
| BWTSP1624    | 7314150203406  | 1   | 330 |
| BWTSP1627    | 7314150203413  | 1   | 330 |
| BWTSP317L    | 7314150335480  | 1   | 329 |
| BWTSP319L    | 7314150335497  | 1   | 329 |
| BWTSP321L    | 7314150335503  | 1   | 329 |
| BWTSP3L      | 7314150335473  | 1   | 329 |
| BWTSP6       | 7314150240043  | 1   | 329 |
| BWTSP617     | 7314150242399  | 1   | 329 |
| BWTSP619     | 7314150242405  | 1   | 329 |
| BWTSP621     | 7314150242412  | 1   | 329 |
| BWTSP622     | 7314150242429  | 1   | 329 |
| BWTSP624     | 7314150242436  | 1   | 329 |
| BWTSP7       | 7314150170302  | 1   | 329 |
| BWTSP732     | 7314150203420  | 1   | 330 |
| BWTSP736     | 7314150203437  | 1   | 330 |
| BWTSP741     | 7314150203444  | 1   | 330 |
| BWTVCTT355   | 7314150347179  | 1   | 332 |
| BWXW1        | 7314150167661  | 1   | 328 |
| BWXW2        | 7314150167678  | 4   | 328 |
| BWXW3        | 7314150214624  | 1   | 328 |
| BWXW4        | 7314150214631  | 1   | 328 |
| BZWTB0132450 | 7314150165674  | 1   | 330 |
| BZWTB0132600 | 7314150165681  | 1   | 330 |
| C0312I03     | 7314150501298  | 5   | 147 |
| C0313M03     | 7311518100636  | 1   | 144 |



|              |               |    |     |
|--------------|---------------|----|-----|
| C0313M03X    | 7311518182045 | 1  | 144 |
| C0616AL06    | 7311518181826 | 1  | 145 |
| C0616M03X    | 7311518204679 | 1  | 144 |
| C0616M06     | 7311518100667 | 1  | 144 |
| C0616M06X    | 7311518100681 | 1  | 144 |
| C0618I06     | 7314150501311 | 5  | 147 |
| C0618S06     | 7314150501342 | 5  | 146 |
| C0820M06     | 7311518100711 | 1  | 144 |
| C0820M06X    | 7311518100735 | 1  | 144 |
| C1020I06     | 7314150501373 | 5  | 147 |
| C1020M06     | 7311518100766 | 1  | 144 |
| C1020M06X    | 7311518100780 | 1  | 144 |
| C1020S06     | 7314150501403 | 5  | 146 |
| C1225AL06    | 7311518187637 | 1  | 145 |
| C1225I06     | 7314150506743 | 5  | 147 |
| C1225M06     | 7311518100810 | 1  | 144 |
| C1225M06X    | 7311518100834 | 1  | 144 |
| C1225M08X    | 7311518187996 | 1  | 144 |
| C1225S06     | 7314150501465 | 5  | 146 |
| C1625M06     | 7311518192266 | 1  | 144 |
| C1625M06X    | 7311518187378 | 1  | 144 |
| C1625M08     | 7311518100902 | 1  | 144 |
| C1625M08X    | 7311518100926 | 1  | 144 |
| C1997LM/9P   | 7314150510375 | 1  | 225 |
| C1997TORX/9P | 7314150510382 | 1  | 226 |
| C3140        | 7314150393312 | 10 | 234 |
| C3140IP      | 7314150391158 | 10 | 234 |
| C3230        | 7314150393329 | 10 | 237 |
| C3230IP      | 7314150391189 | 10 | 237 |
| C3330        | 7314150393336 | 10 | 234 |
| C3330IP      | 7314150391196 | 10 | 234 |
| C3330R       | 7314150393343 | 10 | 234 |
| C3330R IP    | 7314150391202 | 10 | 234 |
| C3340R       | 7314150393350 | 10 | 234 |
| C3340R IP    | 7314150391219 | 10 | 234 |
| C3430        | 7314150393367 | 10 | 245 |
| C3430IP      | 7314150391226 | 10 | 245 |
| C3530        | 7314150393374 | 10 | 246 |
| C3530IP      | 7314150391233 | 10 | 246 |
| C3630        | 7314150393381 | 10 | 242 |
| C3630IP      | 7314150391240 | 10 | 242 |
| C3640        | 7314150393398 | 10 | 242 |
| C3640IP      | 7314150391257 | 10 | 242 |
| C3745        | 7314150393404 | 10 | 243 |
| C3745IP      | 7314150391264 | 10 | 243 |
| C3790        | 7314150393411 | 10 | 243 |
| C3790IP      | 7314150391271 | 10 | 243 |
| C3830        | 7314150393428 | 10 | 242 |
| C3830IP      | 7314150391288 | 10 | 242 |
| C3840        | 7314150393435 | 10 | 242 |
| C3840IP      | 7314150391295 | 10 | 242 |
| C3901/3      | 7314150392797 | 1  | 257 |
| C3902/3      | 7314150399604 | 1  | 258 |
| C3903/2-6    | 7314150466481 | 1  | 258 |
| CFP250       | 7314150400669 | 6  | 612 |
| CHALK-BLUE   | 7314150128686 | 6  | 542 |
| CHALK-RED    | 7314150128709 | 6  | 542 |
| CHALK-WHITE  | 7314150179671 | 6  | 542 |
| CHALK-YELLOW | 7314150128693 | 6  | 542 |
| CL-1221      | 7314150127122 | 6  | 542 |
| CL-1221-SET  | 7314150188574 | 4  | 542 |
| CL-1331      | 7314150347728 | 48 | 542 |
| CL-1441      | 7314150347735 | 36 | 542 |
| CLIPS-1/2    | 7314153003201 | 25 | 95  |
| CLIPS-1/4    | 7314153003188 | 25 | 82  |
| CLIPS-3/8    | 7314153003195 | 25 | 88  |
| CR B 01      | 7314150215409 | 60 | 254 |
| CR B 02      | 7314150215416 | 60 | 254 |
| CR B 03      | 7314150215423 | 60 | 254 |
| CR B 05      | 7314150215454 | 2  | 255 |
| CR B 06      | 7314150215461 | 2  | 255 |
| CR L 01      | 7314150215911 | 1  | 257 |
| CR L 02      | 7314150215928 | 1  | 257 |
| CR L 03      | 7314150215935 | 1  | 257 |
| CR OV 01     | 7314150489978 | 1  | 255 |
| CR SA H01    | 7314150489992 | 1  | 256 |
| CR SA H16    | 7314150508990 | 1  | 256 |
| CR SA S01    | 7314150490011 | 1  | 256 |
| CR SA T01    | 7314150490035 | 1  | 256 |
| CR W 01      | 7314150215492 | 1  | 255 |
| CR W 02      | 7314150215508 | 1  | 255 |
| CR W 03      | 7314150215515 | 1  | 255 |
| CR W 04      | 7314150215522 | 1  | 256 |
| CR W 05      | 7314150215539 | 1  | 256 |
| CR W 06      | 7314150215546 | 1  | 256 |
| CS-SPARE     | 7314150453030 | 1  | 544 |
| CS150        | 7314150125241 | 12 | 544 |
| CS300        | 7314150125258 | 12 | 544 |
| CS400        | 7314150125265 | 12 | 544 |
| D-DD/S20     | 7311518280345 | 4  | 178 |
| D/S10        | 7311518280307 | 6  | 179 |
| D/S14        | 7311518280314 | 6  | 179 |
| D0303I03     | 7314150501281 | 5  | 147 |
| D0303M03     | 7311518100957 | 1  | 144 |
| D0303M03X    | 7311518182052 | 1  | 144 |
| D0605M03X    | 7311518197896 | 1  | 144 |





# D0606106



|               |               |     |     |
|---------------|---------------|-----|-----|
| D0606106      | 7314150501328 | 5   | 147 |
| D0606M06      | 7311518100988 | 1   | 144 |
| D0606M06X     | 7311518101008 | 1   | 144 |
| D0606S06      | 7314150501359 | 5   | 146 |
| D0807M06      | 7311518043896 | 1   | 144 |
| D0807M06X     | 7311518043919 | 1   | 144 |
| D1009M06      | 7311518035280 | 1   | 144 |
| D1009M06X     | 7311518035297 | 1   | 144 |
| D1010I06      | 7314150501380 | 5   | 147 |
| D1010S06      | 7314150501410 | 5   | 146 |
| D1211AL06     | 7311518187644 | 1   | 146 |
| D1211AL08     | 7311518181840 | 1   | 146 |
| D1211M06      | 7311518035334 | 1   | 144 |
| D1211M06X     | 7311518035358 | 1   | 144 |
| D1212I06      | 7314150501441 | 5   | 147 |
| D1212S06      | 7314150501472 | 5   | 146 |
| D1614M06      | 7311518192327 | 1   | 144 |
| D1614M06X     | 7311518187385 | 1   | 144 |
| D1614M08      | 7311518035389 | 1   | 144 |
| D1614M08X     | 7311518035402 | 1   | 144 |
| DD/S10        | 7311518280321 | 6   | 179 |
| DD/S14        | 7311518280338 | 4   | 178 |
| DOW 175-1     | 7314152202728 | 266 | 266 |
| DOW 175-11/2  | 7314152202995 | 1   | 266 |
| DOW 175-2     | 7314152203022 | 1   | 266 |
| DOW 175-3     | 7314152203299 | 1   | 266 |
| DOW 176-1     | 7314152206047 | 1   | 267 |
| DOW 176-11/2  | 7314152206122 | 1   | 267 |
| DOW 176-2     | 7314152206399 | 1   | 267 |
| DOW 177-1/2-1 | 7314152816383 | 1   | 266 |
| DOW 177-11/2  | 7314152816468 | 1   | 266 |
| DOW 177-2     | 7314152816543 | 1   | 266 |
| E0308M03      | 7311518035433 | 1   | 144 |
| E0308M03X     | 7311518192372 | 1   | 144 |
| E0614M06      | 7311518035464 | 1   | 144 |
| E0816M06      | 7311518035518 | 1   | 144 |
| E0816M06X     | 7311518035532 | 1   | 144 |
| E1015I06      | 7314150501496 | 5   | 147 |
| E1018M06      | 7311518035563 | 1   | 144 |
| E1018M06X     | 7311518035587 | 1   | 144 |
| E1220I06      | 7314150501526 | 5   | 147 |
| E1222M06      | 7311518035617 | 1   | 144 |
| E1222M06X     | 7311518035631 | 1   | 144 |
| E1222M08      | 7311518172558 | 1   | 144 |
| E1222M08X     | 7311518199302 | 1   | 144 |
| E1625M06      | 7311518192440 | 1   | 144 |
| E1625M06X     | 7311518187392 | 1   | 144 |
| E1625M08      | 7311518035709 | 1   | 144 |
| E1625M08X     | 7311518035723 | 1   | 144 |
| EX-14-TEN-C   | 7311518298333 | 5   | 563 |
| EX-14-VEN-C   | 7311518298340 | 10  | 563 |
| EX-16-GNP-C   | 7311518298685 | 10  | 560 |
| EX-19-XT9-C   | 7311518298302 | 10  | 562 |
| EX-20-LAM-C   | 7311518298326 | 10  | 563 |
| EX-20-XT11-C  | 7311518298319 | 10  | 563 |
| EX-22-PLS-C   | 7311518298357 | 10  | 560 |
| EX-22-U7      | 7311518300890 | 10  | 562 |
| EX-22-XT7-C   | 7311518298289 | 10  | 564 |
| EX-22-XT9-C   | 7311518298296 | 10  | 562 |
| EX-24-XT7-C   | 7311518298272 | 10  | 564 |
| EX-244P-22    | 7311518298456 | 10  | 564 |
| EX-LL         | 7311518298494 | 4   | 566 |
| EX-NPP-22     | 7311518324162 | 10  | 562 |
| EX-RL         | 7311518298487 | 4   | 566 |
| EX-RM         | 7311518298470 | 4   | 566 |
| F0312I03      | 7314150501502 | 5   | 147 |
| F0313M03      | 7311518035754 | 1   | 144 |
| F0313M03X     | 7311518192495 | 1   | 144 |
| F0613M03X     | 7311518196608 | 1   | 144 |
| F0618AL06     | 7311518181857 | 1   | 146 |
| F0618I06      | 7314150501533 | 5   | 147 |
| F0618M06      | 7311518035792 | 1   | 144 |
| F0618M06X     | 7311518035815 | 1   | 144 |
| F0618S06      | 7314150501564 | 5   | 146 |
| F0820M06      | 7311518035839 | 1   | 144 |
| F0820M06X     | 7311518035860 | 1   | 144 |
| F1020I06      | 7314150501595 | 5   | 147 |
| F1020M06      | 7311518035891 | 1   | 144 |
| F1020M06X     | 7311518035914 | 1   | 144 |
| F1020S06      | 7314150501625 | 5   | 146 |
| F1225AL06     | 7311518187651 | 1   | 146 |
| F1225AL08     | 7311518181864 | 1   | 146 |
| F1225I06      | 7314150501656 | 5   | 147 |
| F1225M06      | 7311518035945 | 1   | 144 |
| F1225M06X     | 7311518036003 | 1   | 144 |
| F1225M08      | 7311518035983 | 1   | 144 |
| F1225M08X     | 7311518192563 | 1   | 144 |
| F1225S06      | 7314150501687 | 5   | 146 |
| F1625M06      | 7311518192570 | 1   | 144 |
| F1625M06X     | 7311518187408 | 1   | 144 |
| F1625M08      | 7311518036034 | 1   | 144 |
| FCP-1.8-810   | 7311518123970 | 4   | 600 |
| FCP-2.3-860   | 7311518123994 | 2   | 600 |
| FCS-1000      | 7314150321551 | 6   | 545 |
| FCS-600       | 7314150321537 | 6   | 545 |
| FCS-800       | 7314150321544 | 6   | 545 |



|           |               |   |     |
|-----------|---------------|---|-----|
| FF1A01    | 7314150228560 | 1 | 395 |
| FF1A02    | 7314150228591 | 1 | 395 |
| FF1A03    | 7314150228607 | 1 | 395 |
| FF1A04    | 7314150227778 | 1 | 395 |
| FF1A051   | 7314150478446 | 1 | 395 |
| FF1A06    | 7314150227822 | 1 | 396 |
| FF1A07    | 7314150227846 | 1 | 396 |
| FF1A08    | 7314150227976 | 1 | 396 |
| FF1A09    | 7314150227990 | 1 | 396 |
| FF1A1004  | 7314150286454 | 1 | 396 |
| FF1A1010  | 7314150320660 | 1 | 397 |
| FF1A1011  | 7314150339068 | 1 | 397 |
| FF1A102   | 7314150334841 | 1 | 397 |
| FF1A104   | 7314150334865 | 1 | 397 |
| FF1A106   | 7314150335541 | 1 | 397 |
| FF1A11    | 7314150228034 | 1 | 397 |
| FF1A110   | 7314150335619 | 1 | 398 |
| FF1A112   | 7314150335572 | 1 | 398 |
| FF1A114   | 7314150335633 | 1 | 398 |
| FF1A115   | 7314150335640 | 1 | 398 |
| FF1A117   | 7314150335701 | 1 | 398 |
| FF1A118   | 7314150335732 | 1 | 398 |
| FF1A119   | 7314150335749 | 1 | 399 |
| FF1A12    | 7314150228058 | 1 | 399 |
| FF1A121   | 7314150335718 | 1 | 399 |
| FF1A124   | 7314150335725 | 1 | 399 |
| FF1A127   | 7314150336395 | 1 | 399 |
| FF1A128   | 7314150336586 | 1 | 399 |
| FF1A129   | 7314150336593 | 1 | 400 |
| FF1A13    | 7314150228072 | 1 | 400 |
| FF1A130   | 7314150336661 | 1 | 400 |
| FF1A131   | 7314150336678 | 1 | 400 |
| FF1A132   | 7314150336685 | 1 | 400 |
| FF1A133   | 7314150336692 | 1 | 401 |
| FF1A134   | 7314150336708 | 1 | 401 |
| FF1A135   | 7314150336715 | 1 | 401 |
| FF1A136   | 7314150336722 | 1 | 401 |
| FF1A137   | 7314150336739 | 1 | 401 |
| FF1A138   | 7314150336746 | 1 | 402 |
| FF1A139   | 7314150336753 | 1 | 402 |
| FF1A14    | 7314150228089 | 1 | 402 |
| FF1A141   | 7314150336777 | 1 | 402 |
| FF1A142   | 7314150338573 | 1 | 402 |
| FF1A143   | 7314150338580 | 1 | 402 |
| FF1A145   | 7314150338603 | 1 | 403 |
| FF1A146   | 7314150338610 | 1 | 403 |
| FF1A147   | 7314150338627 | 1 | 403 |
| FF1A15    | 7314150228096 | 1 | 403 |
| FF1A153   | 7314150350445 | 1 | 403 |
| FF1A154   | 7314150350476 | 1 | 404 |
| FF1A16    | 7314150228102 | 1 | 404 |
| FF1A164   | 7314150350957 | 1 | 404 |
| FF1A165   | 7314150350964 | 1 | 404 |
| FF1A167   | 7314150350988 | 1 | 404 |
| FF1A168   | 7314150350995 | 1 | 404 |
| FF1A169   | 7314150351008 | 1 | 405 |
| FF1A170   | 7314150351800 | 1 | 405 |
| FF1A18    | 7314150228126 | 1 | 405 |
| FF1A185   | 7314150358694 | 1 | 405 |
| FF1A189   | 7314150405961 | 1 | 405 |
| FF1A19    | 7314150254354 | 1 | 405 |
| FF1A194   | 7314150431496 | 1 | 406 |
| FF1A195LM | 7314150455850 | 1 | 389 |
| FF1A196LM | 7314150455874 | 1 | 390 |
| FF1A197LM | 7314150455881 | 1 | 390 |
| FF1A198LM | 7314150455898 | 1 | 390 |
| FF1A199LM | 7314150455904 | 1 | 390 |
| FF1A20    | 7314150254361 | 1 | 406 |
| FF1A200LM | 7314150455928 | 1 | 390 |
| FF1A201LM | 7314150455935 | 1 | 390 |
| FF1A202LM | 7314150455966 | 1 | 391 |
| FF1A203LM | 7314150455973 | 1 | 391 |
| FF1A204LM | 7314150455980 | 1 | 391 |
| FF1A205LM | 7314150455997 | 1 | 391 |
| FF1A206LM | 7314150456000 | 1 | 391 |
| FF1A207LM | 7314150456017 | 1 | 391 |
| FF1A208LM | 7314150456024 | 1 | 392 |
| FF1A209LM | 7314150456031 | 1 | 392 |
| FF1A210LM | 7314150456062 | 1 | 392 |
| FF1A211LM | 7314150456079 | 1 | 392 |
| FF1A212LM | 7314150456086 | 1 | 392 |
| FF1A213   | 7314150437283 | 1 | 392 |
| FF1A214LM | 7314150456093 | 1 | 393 |
| FF1A215LM | 7314150456109 | 1 | 393 |
| FF1A216LM | 7314150456123 | 1 | 393 |
| FF1A218LM | 7314150456130 | 1 | 393 |
| FF1A219LM | 7314150456147 | 1 | 393 |
| FF1A22    | 7314150254385 | 1 | 406 |
| FF1A220LM | 7314150456154 | 1 | 394 |
| FF1A221LM | 7314150456161 | 1 | 394 |
| FF1A222LM | 7314150456178 | 1 | 394 |
| FF1A223LM | 7314150456185 | 1 | 394 |
| FF1A224LM | 7314150456192 | 1 | 394 |
| FF1A225LM | 7314150456208 | 1 | 394 |
| FF1A23    | 7314150254392 | 1 | 406 |
| FF1A230   | 7314150461455 | 1 | 406 |

|                 |               |   |     |
|-----------------|---------------|---|-----|
| FF1A2301        | 7314150286508 | 1 | 407 |
| FF1A235         | 7314150500666 | 1 | 407 |
| FF1A236         | 7314150500680 | 1 | 407 |
| FF1A24          | 7314150254408 | 1 | 407 |
| FF1A25          | 7314150254415 | 1 | 407 |
| FF1A2501        | 7314150286492 | 1 | 408 |
| FF1A2503        | 7314150320677 | 1 | 408 |
| FF1A26          | 7314150254422 | 1 | 408 |
| FF1A28          | 7314150254446 | 1 | 408 |
| FF1A29NB        | 7314150266340 | 1 | 409 |
| FF1A3001        | 7314150286515 | 1 | 409 |
| FF1A3002        | 7314150289264 | 1 | 409 |
| FF1A3003        | 7314150286522 | 1 | 409 |
| FF1A3004        | 7314150286676 | 1 | 409 |
| FF1A3005        | 7314150286638 | 1 | 409 |
| FF1A30NB        | 7314150266357 | 1 | 409 |
| FF1A31NB        | 7314150266364 | 1 | 410 |
| FF1A35          | 7314150264124 | 1 | 410 |
| FF1A36          | 7314150265862 | 1 | 410 |
| FF1A37          | 7314150265855 | 1 | 410 |
| FF1A39          | 7314150266920 | 1 | 410 |
| FF1A4001        | 7314150286713 | 1 | 410 |
| FF1A4002        | 7314150286560 | 1 | 411 |
| FF1A4003        | 7314150286706 | 1 | 411 |
| FF1A41          | 7314150266982 | 1 | 411 |
| FF1A48          | 7314150271801 | 1 | 411 |
| FF1A50          | 7314150271825 | 1 | 411 |
| FF1A5002        | 7314150286447 | 1 | 411 |
| FF1A5003        | 7314150286690 | 1 | 412 |
| FF1A5004        | 7314150286539 | 1 | 412 |
| FF1A5005        | 7314150286546 | 1 | 412 |
| FF1A5006        | 7314150286683 | 1 | 412 |
| FF1A5007        | 7314150286553 | 1 | 413 |
| FF1A5008        | 7314150286607 | 1 | 413 |
| FF1A5009        | 7314150286669 | 1 | 413 |
| FF1A5010        | 7314150286584 | 1 | 413 |
| FF1A5011        | 7314150286614 | 1 | 413 |
| FF1A5012        | 7314150286652 | 1 | 414 |
| FF1A5013        | 7314150286577 | 1 | 414 |
| FF1A5015        | 7314150307401 | 1 | 414 |
| FF1A5017        | 7314150307425 | 1 | 414 |
| FF1A5019        | 7314150309436 | 1 | 414 |
| FF1A5021        | 7314150309467 | 1 | 414 |
| FF1A5022        | 7314150309474 | 1 | 415 |
| FF1A5023        | 7314150309498 | 1 | 415 |
| FF1A5024        | 7314150309504 | 1 | 415 |
| FF1A5027        | 7314150320684 | 1 | 415 |
| FF1A5028        | 7314150320691 | 1 | 415 |
| FF1A5029        | 7314150320707 | 1 | 416 |
| FF1A5030        | 7314150320714 | 1 | 416 |
| FF1A5031        | 7314150320721 | 1 | 416 |
| FF1A5032        | 7314150320738 | 1 | 416 |
| FF1A5036        | 7314150339037 | 1 | 416 |
| FF1A5037        | 7314150339044 | 1 | 416 |
| FF1A5038        | 7314150339051 | 1 | 417 |
| FF1A51          | 7314150271832 | 1 | 417 |
| FF1A53          | 7314150271856 | 1 | 417 |
| FF1A54          | 7314150288786 | 1 | 417 |
| FF1A55          | 7314150299720 | 1 | 417 |
| FF1A56          | 7314150299737 | 1 | 417 |
| FF1A65          | 7314150313389 | 1 | 418 |
| FF1A66          | 7314150313396 | 1 | 418 |
| FF1A67          | 7314150313402 | 1 | 418 |
| FF1A68          | 7314150313419 | 1 | 418 |
| FF1A70          | 7314150320189 | 1 | 418 |
| FF1A71          | 7314150320196 | 1 | 418 |
| FF1A72          | 7314150320202 | 1 | 419 |
| FF1A82          | 7314150334070 | 1 | 419 |
| FF1ASET-AUTO    | 7314150437993 | 1 | 387 |
| FF1ASET-AUTO-M1 | 7314150438259 | 1 | 388 |
| FF1ASET-AUTO-M2 | 7314150438327 | 1 | 388 |
| FF1ASET-AUTO-M3 | 7314150438334 | 1 | 388 |
| FF1ASET-AUTO-M4 | 7314150438341 | 1 | 389 |
| FF1ASET-AUTO-M5 | 7314150438358 | 1 | 389 |
| FF1ASET-AUTO-M6 | 7314150438365 | 1 | 389 |
| FF1ASET-AUTO1   | 7314150254453 | 1 | 387 |
| FF1ASET-AUTO2   | 7314150254460 | 1 | 388 |
| FF1ASET-AUTO3   | 7314150254477 | 1 | 388 |
| FF1ASET-AUTO6   | 7314150319909 | 1 | 388 |
| FF1ASET-BASIC   | 7314150437368 | 1 | 387 |
| FF1ASET-LARGE   | 7314150437108 | 1 | 386 |
| FF1ASET-MRO2    | 7314150336623 | 1 | 387 |
| FF1ASET-MRO3    | 7314150336630 | 1 | 387 |
| FF1ASET-MRO4    | 7314150336647 | 1 | 387 |
| FF1ASET-MRO5    | 7314150336654 | 1 | 387 |
| FF1ASET-XLARGE  | 7314150436965 | 1 | 386 |
| FF1B01LM        | 7314150455416 | 1 | 384 |
| FF1B02LM        | 7314150455447 | 1 | 384 |
| FF1B03LM        | 7314150455454 | 1 | 385 |
| FF1B04LM        | 7314150455478 | 1 | 385 |
| FF1B05LM        | 7314150455515 | 1 | 385 |
| FF1B06LM        | 7314150455522 | 1 | 385 |
| FF1B07LM        | 7314150455614 | 1 | 385 |
| FF1B08LM        | 7314150455645 | 1 | 386 |
| FF1B09LM        | 7314150455669 | 1 | 386 |
| FF1B10LM        | 7314150455706 | 1 | 386 |

|                 |               |   |     |
|-----------------|---------------|---|-----|
| FF1B11LM        | 7314150455713 | 1 | 386 |
| FF1BSET-MONSTER | 7314150436835 | 1 | 384 |
| FF1E1001        | 7314150285839 | 1 | 425 |
| FF1E1002        | 7314150285761 | 1 | 425 |
| FF1E1003        | 7314150285853 | 1 | 425 |
| FF1E1004        | 7314150285754 | 1 | 425 |
| FF1E1005        | 7314150285785 | 1 | 426 |
| FF1E1006        | 7314150285778 | 1 | 426 |
| FF1E1007        | 7314150285792 | 1 | 426 |
| FF1E1008        | 7314150285822 | 1 | 426 |
| FF1E1009        | 7314150285808 | 1 | 426 |
| FF1E1009EH      | 7314150352579 | 1 | 433 |
| FF1E1010        | 7314150285815 | 1 | 426 |
| FF1E1011        | 7314150285846 | 1 | 426 |
| FF1E1012EH      | 7314150352562 | 1 | 433 |
| FF1E1013EH      | 7314150352586 | 1 | 433 |
| FF1E2001        | 7314150285945 | 1 | 426 |
| FF1E2002        | 7314150285921 | 1 | 427 |
| FF1E2003        | 7314150286072 | 1 | 427 |
| FF1E2004        | 7314150285952 | 1 | 427 |
| FF1E2005        | 7314150285976 | 1 | 427 |
| FF1E2006        | 7314150285914 | 1 | 427 |
| FF1E2007        | 7314150285907 | 1 | 427 |
| FF1E2008        | 7314150285860 | 1 | 428 |
| FF1E2009EH      | 7314150352593 | 1 | 434 |
| FF1E2010EH      | 7314150352654 | 1 | 434 |
| FF1E2011EH      | 7314150373802 | 1 | 435 |
| FF1E2101        | 7314150285877 | 1 | 428 |
| FF1E2102        | 7314150286058 | 1 | 428 |
| FF1E2103        | 7314150286089 | 1 | 428 |
| FF1E2104        | 7314150285990 | 1 | 428 |
| FF1E2105        | 7314150286041 | 1 | 428 |
| FF1E2106EH      | 7314150352623 | 1 | 434 |
| FF1E2107EH      | 7314150352661 | 1 | 434 |
| FF1E2201        | 7314150286010 | 1 | 429 |
| FF1E2202        | 7314150285891 | 1 | 429 |
| FF1E2203        | 7314150285884 | 1 | 429 |
| FF1E2204        | 7314150285983 | 1 | 429 |
| FF1E2205        | 7314150285938 | 1 | 429 |
| FF1E2206        | 7314150286034 | 1 | 429 |
| FF1E2207        | 7314150285969 | 1 | 430 |
| FF1E2208        | 7314150286027 | 1 | 430 |
| FF1E2209        | 7314150286096 | 1 | 430 |
| FF1E2210        | 7314150286065 | 1 | 430 |
| FF1E2211        | 7314150339006 | 1 | 430 |
| FF1E2212        | 7314150339013 | 1 | 430 |
| FF1E2213        | 7314150339020 | 1 | 431 |
| FF1E2214EH      | 7314150352647 | 1 | 434 |
| FF1E2215EH      | 7314150352678 | 1 | 434 |
| FF1E2216EH      | 7314150373833 | 1 | 436 |
| FF1E2501        | 7314150286003 | 1 | 431 |
| FF1E2502        | 7314150338993 | 1 | 431 |
| FF1E2503EH      | 7314150352685 | 1 | 434 |
| FF1E2504EH      | 7314150374106 | 1 | 436 |
| FF1E2505EH      | 7314150373826 | 1 | 436 |
| FF1E3001        | 7314150286119 | 1 | 431 |
| FF1E3002        | 7314150286102 | 1 | 431 |
| FF1E3003        | 7314150286157 | 1 | 432 |
| FF1E3004        | 7314150286133 | 1 | 432 |
| FF1E3005        | 7314150286126 | 1 | 432 |
| FF1E3006        | 7314150286140 | 1 | 432 |
| FF1E3007        | 7314150286164 | 1 | 432 |
| FF1E3008        | 7314150286171 | 1 | 432 |
| FF1E3009EH      | 7314150352722 | 1 | 434 |
| FF1E3010EH      | 7314150352739 | 1 | 435 |
| FF1E3011EH      | 7314150352753 | 1 | 435 |
| FF1E4001        | 7314150285747 | 1 | 432 |
| FF1E4002        | 7314150285730 | 1 | 432 |
| FF1E4003EH      | 7314150352692 | 1 | 435 |
| FF1E4004EH      | 7314150352708 | 1 | 435 |
| FF1E4005EH      | 7314150352807 | 1 | 435 |
| FF1E5001        | 7314150285716 | 1 | 433 |
| FF1E5002        | 7314150285709 | 1 | 433 |
| FF1E5003        | 7314150285723 | 1 | 433 |
| FF1E5004        | 7314150338931 | 1 | 433 |
| FF1E5005        | 7314150338948 | 1 | 431 |
| FF1E5006        | 7314150338955 | 1 | 431 |
| FF1E5007        | 7314150338962 | 1 | 432 |
| FF1E5008        | 7314150338979 | 1 | 432 |
| FF1E5009        | 7314150338986 | 1 | 431 |
| FF1E5010EH      | 7314150352746 | 1 | 435 |
| FF1E5011EH      | 7314150352777 | 1 | 435 |
| FF1E5013EH      | 7314150352821 | 1 | 435 |
| FF1E5014EH      | 7314150373864 | 1 | 436 |
| FF1E5015EH      | 7314150373871 | 1 | 436 |
| FF1E5016EH      | 7314150373888 | 1 | 436 |
| FF1F1001        | 7314150286270 | 1 | 419 |
| FF1F1002        | 7314150286287 | 1 | 419 |
| FF1F1003        | 7314150286294 | 1 | 419 |
| FF1F1004        | 7314150286263 | 1 | 419 |
| FF1F1005        | 7314150286300 | 1 | 419 |
| FF1F1006        | 7314150286249 | 1 | 420 |
| FF1F1007        | 7314150286256 | 1 | 420 |
| FF1F1008        | 7314150339129 | 1 | 420 |
| FF1F1009        | 7314150339136 | 1 | 420 |
| FF1F2001        | 7314150286317 | 1 | 420 |







|                 |               |    |     |
|-----------------|---------------|----|-----|
| FF1F2002        | 7314150339143 | 1  | 420 |
| FF1F2101        | 7314150286331 | 1  | 420 |
| FF1F2102        | 7314150339105 | 1  | 421 |
| FF1F2103        | 7314150339112 | 1  | 421 |
| FF1F2201        | 7314150286324 | 1  | 421 |
| FF1F2202        | 7314150339150 | 1  | 421 |
| FF1F2203        | 7314150339167 | 1  | 421 |
| FF1F3001        | 7314150286348 | 1  | 421 |
| FF1F3002        | 7314150286379 | 1  | 422 |
| FF1F3003        | 7314150286409 | 1  | 422 |
| FF1F3004        | 7314150286386 | 1  | 422 |
| FF1F3005        | 7314150286362 | 1  | 422 |
| FF1F3006        | 7314150286355 | 1  | 422 |
| FF1F3007        | 7314150286393 | 1  | 422 |
| FF1F3008        | 7314150286423 | 1  | 422 |
| FF1F3009        | 7314150286416 | 1  | 422 |
| FF1F3010        | 7314150339082 | 1  | 423 |
| FF1F3011        | 7314150339099 | 1  | 423 |
| FF1F4001        | 7314150286195 | 1  | 423 |
| FF1F4002        | 7314150286201 | 1  | 423 |
| FF1F4003        | 7314150286225 | 1  | 423 |
| FF1F4004        | 7314150286232 | 1  | 423 |
| FF1F4005        | 7314150286218 | 1  | 423 |
| FF1F5001        | 7314150286188 | 1  | 424 |
| FF1F5002        | 7314150339174 | 1  | 424 |
| FF1F5003        | 7314150339181 | 1  | 424 |
| FF1F5004        | 7314150339198 | 1  | 421 |
| FF1F5005        | 7314150339204 | 1  | 424 |
| FF1F5006        | 7314150339211 | 1  | 424 |
| FF1F5007        | 7314150339228 | 1  | 424 |
| FF1F5008        | 7314150339235 | 1  | 424 |
| FF1F5009        | 7314150339242 | 1  | 425 |
| FF1F5010        | 7314150339259 | 1  | 425 |
| FF1F5011        | 7314150339266 | 1  | 425 |
| FF1F5012        | 7314150339273 | 1  | 425 |
| FF1F5013        | 7314150339280 | 1  | 421 |
| FF2A07          | 7314150228201 | 1  | 444 |
| FF2A08          | 7314150228225 | 1  | 444 |
| FF2A09          | 7314150228249 | 1  | 445 |
| FF2A10          | 7314150228263 | 1  | 445 |
| FF2B01          | 7314150233441 | 1  | 445 |
| FF2B02          | 7314150233465 | 1  | 445 |
| FF2B03          | 7314150233489 | 1  | 445 |
| FF2B04          | 7314150233502 | 1  | 446 |
| FF2B05          | 7314150233526 | 1  | 446 |
| FF2B06          | 7314150233540 | 1  | 446 |
| FF2B07          | 7314150229420 | 1  | 446 |
| FF2B08          | 7314150229451 | 1  | 446 |
| FF2B09          | 7314150229482 | 1  | 446 |
| FF2B10          | 7314150229505 | 1  | 447 |
| FF2B11          | 7314150229529 | 1  | 447 |
| FF2B12          | 7314150229543 | 1  | 447 |
| FF2B13          | 7314150229567 | 1  | 447 |
| FF2B14          | 7314150229581 | 1  | 447 |
| FF2B15          | 7314150229604 | 1  | 448 |
| FF2B16          | 7314150229628 | 1  | 448 |
| FF3A01          | 7314150228300 | 1  | 458 |
| FF3A02          | 7314150228324 | 1  | 459 |
| FF3A03          | 7314150228348 | 1  | 459 |
| FF3A04          | 7314150228362 | 1  | 459 |
| FF3A05          | 7314150228386 | 1  | 459 |
| FF3A06          | 7314150228416 | 1  | 459 |
| FF3A07          | 7314150228430 | 1  | 460 |
| FF3A08          | 7314150228454 | 1  | 460 |
| FF3A09          | 7314150228478 | 1  | 460 |
| FF3A10          | 7314150228492 | 1  | 460 |
| FF3A11          | 7314150228515 | 1  | 448 |
| FF3A12          | 7314150228539 | 1  | 449 |
| FF3A13          | 7314150228614 | 1  | 449 |
| FF3A14          | 7314150228638 | 1  | 449 |
| FF3A15          | 7314150228652 | 1  | 449 |
| FF3A16          | 7314150228676 | 1  | 449 |
| FF3A17          | 7314150228690 | 1  | 450 |
| FFSS-1.5-900FG  | 7311518275884 | 4  | 600 |
| FGS-1.0-600     | 7311518123796 | 4  | 600 |
| FGS-1.25-700    | 7311518123802 | 4  | 600 |
| FGS-1.25-700-WB | 7314150398720 | 4  | 600 |
| FGS-1.6-810     | 7311518123819 | 4  | 600 |
| FGS-1.6-810-WB  | 7314150399086 | 4  | 600 |
| FGS-1.8-810     | 7311518123826 | 4  | 600 |
| FM10            | 7311518010881 | 5  | 31  |
| FM12            | 7314150273249 | 5  | 31  |
| FP-3M           | 7311518168612 | 1  | 626 |
| FS-5            | 7311518266455 | 10 | 632 |
| FS-7.5          | 7311518266479 | 10 | 633 |
| FS-8            | 7311518266462 | 10 | 632 |
| G0313M03        | 7311518036089 | 1  | 144 |
| G0313M03X       | 7311518182069 | 1  | 144 |
| G0613M03X       | 7311518196592 | 1  | 144 |
| G0618M06        | 7311518036119 | 1  | 144 |
| G0618M06X       | 7311518036133 | 1  | 144 |
| G0820M06        | 7311518036164 | 1  | 144 |
| G0820M06X       | 7311518036188 | 1  | 144 |
| G1020I06        | 7314150501519 | 5  | 147 |
| G1020M06        | 7311518036218 | 1  | 144 |
| G1020M06X       | 7311518036232 | 1  | 144 |



|                 |               |    |     |
|-----------------|---------------|----|-----|
| G1020S06        | 7314150501540 | 5  | 146 |
| G1225I06        | 7314150501571 | 5  | 147 |
| G1225M06        | 7311518036317 | 1  | 144 |
| G1225M06X       | 7311518036331 | 1  | 144 |
| G1225M08        | 7311518036362 | 1  | 144 |
| G1225M08X       | 7311518188009 | 1  | 144 |
| G1225S06        | 7314150501601 | 5  | 146 |
| G1625M06        | 7311518192648 | 1  | 144 |
| G1625M06X       | 7311518187415 | 1  | 144 |
| G1625M08        | 7311518036409 | 1  | 144 |
| G1625M08X       | 7311518036423 | 1  | 144 |
| GL008-10        | 7314150167050 | 5  | 490 |
| GL008-8         | 7314150167043 | 5  | 490 |
| GL010-10        | 7314150167098 | 5  | 490 |
| GL010-8         | 7314150167081 | 5  | 490 |
| GS-180-F        | 7311518275488 | 6  | 632 |
| GS-76           | 7311518010782 | 8  | 631 |
| H0613M03X       | 7311518196615 | 1  | 145 |
| H1020I06        | 7314150501717 | 5  | 147 |
| H1025M06        | 7311518182304 | 1  | 145 |
| H1025M06X       | 7311518182311 | 1  | 145 |
| H1232I06        | 7314150501748 | 5  | 147 |
| H1232M06        | 7311518182076 | 1  | 145 |
| H1232M06X       | 7311518181758 | 1  | 145 |
| H1635M06        | 7311518192730 | 1  | 145 |
| H1635M06X       | 7311518187422 | 1  | 145 |
| H1635M08        | 7311518182083 | 1  | 145 |
| H1635M08X       | 7311518182090 | 1  | 145 |
| HFGPS-0.7-400FG | 7311518275877 | 4  | 600 |
| HGPS-0.6-360    | 7311518123680 | 10 | 600 |
| HGPS-0.8-380    | 7311518123697 | 4  | 600 |
| HGPS-0.8-380-WB | 7314150398812 | 4  | 600 |
| HGPS-1.0-400    | 7311518123703 | 4  | 600 |
| HGPS-1.0-400-WB | 7314150398713 | 4  | 600 |
| HRFM10          | 7311518010898 | 5  | 31  |
| HS 7590         | 7314150109395 | 1  | 650 |
| HS 7890         | 7314150109401 | 1  | 651 |
| HS 7891         | 7314150109425 | 10 | 651 |
| HS 7892         | 7314150109432 | 1  | 651 |
| HS 7893         | 7314150109456 | 1  | 652 |
| HS 8130         | 7314150107773 | 1  | 644 |
| HS 8131         | 7314150107803 | 1  | 644 |
| HS 8132         | 7314150107810 | 1  | 644 |
| HS 8140         | 7314150107926 | 10 | 644 |
| HS 8141         | 7314150107940 | 10 | 644 |
| HS 8142         | 7314150107964 | 10 | 644 |
| HS 8143         | 7314150107988 | 10 | 645 |
| HS 8144         | 7314150108008 | 10 | 645 |
| HS 8145         | 7314150108022 | 10 | 645 |
| HS 8148         | 7314150108084 | 10 | 645 |
| HS 8150         | 7314150108114 | 1  | 644 |
| HS 8160         | 7314150108305 | 10 | 644 |
| HS 8161         | 7314150108329 | 10 | 644 |
| HS 8162         | 7314150108343 | 10 | 644 |
| HS 8163         | 7314150108367 | 10 | 645 |
| HS 8164         | 7314150402144 | 10 | 645 |
| HS 8247         | 7314150108480 | 1  | 647 |
| HS 8248         | 7314150108503 | 10 | 647 |
| HS122M.030      | 7314150423293 | 5  | 653 |
| HS6000          | 7314150113781 | 10 | 648 |
| HS6001          | 7314150476466 | 10 | 648 |
| HS7190          | 7314150475988 | 1  | 645 |
| HS7191          | 7314150476473 | 1  | 645 |
| HS7280          | 7314150476480 | 1  | 647 |
| HS7285          | 7314150476497 | 1  | 647 |
| HS7290          | 7314150476503 | 1  | 646 |
| HS7291          | 7314150476510 | 1  | 646 |
| HS7292          | 7314150383719 | 10 | 646 |
| HS7293          | 7314150476527 | 1  | 646 |
| HS7490          | 7314150350674 | 10 | 650 |
| HS7894          | 7314150476534 | 1  | 652 |
| HS8133          | 7314150476541 | 1  | 645 |
| HS8134          | 7314150476555 | 1  | 645 |
| HS8135          | 7314150476572 | 1  | 645 |
| HS8136          | 7314150476589 | 1  | 645 |
| HS8137          | 7314150476596 | 1  | 645 |
| HS8138          | 7314150476602 | 1  | 645 |
| HS8146          | 7314150425372 | 10 | 645 |
| HS8147          | 7314150351954 | 10 | 645 |
| HS8149          | 7314150476619 | 1  | 648 |
| HS8151          | 7314150349388 | 10 | 644 |
| HS8152          | 7314150476626 | 10 | 644 |
| HS8153          | 7314150360055 | 10 | 645 |
| HS8154          | 7314150349418 | 10 | 645 |
| HS8155          | 7314150476633 | 1  | 645 |
| HS8156          | 7314150476640 | 1  | 645 |
| HS8157          | 7314150476657 | 1  | 645 |
| HS8158          | 7314150476664 | 1  | 645 |
| HS8165          | 7314150374526 | 10 | 645 |
| HS8166          | 7314150476671 | 1  | 645 |
| HS8167          | 7314150476688 | 1  | 645 |
| HS8168          | 7314150476695 | 1  | 645 |
| HS8211          | 7314150365067 | 10 | 646 |
| HUS-0.6-380     | 7311518123659 | 4  | 600 |
| HUS-0.8-500     | 7311518123666 | 4  | 600 |
| HUS-1.0-650     | 7311518123673 | 4  | 600 |



|                |               |    |     |
|----------------|---------------|----|-----|
| IZO-D-135      | 7314151845827 | 1  | 105 |
| IZO-D-200      | 7314151846831 | 1  | 105 |
| IZO-D-30       | 7314151846824 | 1  | 105 |
| IZO-D-340      | 7314151846848 | 1  | 105 |
| IZO-DR-810     | 7314151846817 | 1  | 105 |
| J0604M06       | 7311518036508 | 1  | 145 |
| J1010M06       | 7311518172473 | 1  | 145 |
| J1212M06       | 7311518036577 | 1  | 145 |
| J1616M06       | 7311518187439 | 1  | 145 |
| J1616M08       | 7311518036614 | 1  | 145 |
| K-AP-1         | 7311518030117 | 10 | 632 |
| K-GP-1         | 7311518030131 | 10 | 632 |
| K0602M06       | 7311518036652 | 1  | 145 |
| K1008M06       | 7311518036683 | 1  | 145 |
| K1210M06       | 7311518036720 | 1  | 145 |
| K1612M06       | 7311518193959 | 1  | 145 |
| K1612M08       | 7311518036768 | 1  | 145 |
| K172           | 7314150384396 | 1  | 173 |
| K18NF-2        | 7314151347161 | 1  | 170 |
| K18PH-2M5      | 7314153019646 | 1  | 170 |
| K18PH-2M6      | 7314150274871 | 1  | 170 |
| K19PZD-2M5     | 7314151693237 | 1  | 170 |
| K19PZD-2NF     | 7314151586157 | 1  | 170 |
| K20TORX-T25    | 7314151825799 | 1  | 170 |
| K560F-1        | 7314151825492 | 5  | 173 |
| K560F-2        | 7314151825324 | 5  | 174 |
| K560F-3        | 7314151825331 | 5  | 174 |
| K560F-4        | 7314151825348 | 5  | 178 |
| K560F-5        | 7314151825355 | 5  | 178 |
| K560F-6        | 7314151825362 | 5  | 181 |
| K560F-7        | 7314151825379 | 5  | 183 |
| K560F-8        | 7314151825508 | 5  | 183 |
| K560F-9        | 7314151846688 | 5  | 185 |
| K66100-1/4     | 7314150204540 | 1  | 172 |
| K66100-1/4-1P  | 7314150260201 | 1  | 172 |
| K66100-3/8     | 7314150204564 | 1  | 172 |
| K66100-3/8-1P  | 7314150260249 | 1  | 172 |
| K6625-1/4-1P   | 7314150260140 | 1  | 172 |
| K6625-1/4B-5P  | 7314150533305 | 1  | 172 |
| K6638-3/8      | 7314150204557 | 1  | 172 |
| K6638-3/8-1P   | 7314150260164 | 1  | 172 |
| K6650-1/2-1P   | 7314150260188 | 1  | 172 |
| K6650-1/2P-5P  | 7314150533367 | 1  | 172 |
| K6650-1/4B-1P  | 7314150533381 | 1  | 172 |
| K6650-1/4P-5P  | 7314150533404 | 1  | 172 |
| K6650-3/8-1P   | 7314150260225 | 1  | 172 |
| K6650-3/8P-5P  | 7314150533442 | 1  | 172 |
| K6660-QR-1P    | 7314150204571 | 1  | 172 |
| K6701M-10      | 7314151778149 | 1  | 172 |
| K6701M-11      | 7314151778224 | 1  | 172 |
| K6701M-12      | 7314151811891 | 1  | 172 |
| K6701M-13      | 7314151778491 | 1  | 172 |
| K6701M-14      | 7314151844172 | 1  | 172 |
| K6701M-6       | 7314151813260 | 1  | 172 |
| K6701M-7       | 7314151777920 | 1  | 172 |
| K6701M-8       | 7314151778064 | 1  | 172 |
| K6701M-9       | 7314151815110 | 1  | 172 |
| K6750-1/4      | 7314150204663 | 1  | 170 |
| K6750-10-1P    | 7314150533466 | 1  | 170 |
| K6750-13       | 7314150204823 | 1  | 170 |
| K6750-3/8      | 7314150204656 | 1  | 170 |
| K6750-6        | 7314150204670 | 1  | 170 |
| K6750-7        | 7314150204687 | 1  | 170 |
| K6964C         | 7314151215170 | 1  | 174 |
| K7401M-10      | 7314151780128 | 1  | 173 |
| K7401M-11      | 7314151780395 | 1  | 173 |
| K7401M-12      | 7314151811907 | 1  | 173 |
| K7401M-13      | 7314151780470 | 1  | 173 |
| K7401M-14      | 7314151780555 | 1  | 173 |
| K7401M-15      | 7314151812140 | 1  | 173 |
| K7401M-16      | 7314151780630 | 1  | 173 |
| K7401M-17      | 7314151780715 | 1  | 173 |
| K7401M-18      | 7314151812157 | 1  | 173 |
| K7401M-19      | 7314151812164 | 1  | 173 |
| K7401M-20      | 7314151844271 | 1  | 173 |
| K7401M-21      | 7314151845216 | 1  | 173 |
| K7401M-22      | 7314151845223 | 1  | 173 |
| K7401M-24      | 7314151844295 | 1  | 173 |
| K7401M-7       | 7314151812126 | 1  | 173 |
| K7401M-8       | 7314151780043 | 1  | 173 |
| K7401M-9       | 7314151812133 | 1  | 173 |
| K7401M/10      | 7314150389919 | 1  | 174 |
| K7401TORX-E-S7 | 7314150343324 | 1  | 175 |
| K7401TORX-E10  | 7314151844448 | 1  | 174 |
| K7401TORX-E12  | 7314151844455 | 1  | 174 |
| K7401TORX-E14  | 7314151844462 | 1  | 174 |
| K7401TORX-E5   | 7314151844400 | 1  | 174 |
| K7401TORX-E6   | 7314151844417 | 1  | 174 |
| K7401TORX-E7   | 7314151844424 | 1  | 174 |
| K7401TORX-E8   | 7314151844431 | 1  | 174 |
| K7401Z-1/2     | 7314150384402 | 1  | 173 |
| K7401Z-11/16   | 7314150384419 | 1  | 173 |
| K7401Z-13/16   | 7314150384426 | 1  | 173 |
| K7401Z-3/4     | 7314150384433 | 1  | 173 |
| K7401Z-3/8     | 7314150384440 | 1  | 173 |
| K7401Z-5/8     | 7314150384457 | 1  | 173 |



|               |               |    |     |
|---------------|---------------|----|-----|
| K7401Z-7/16   | 7314150384464 | 1  | 173 |
| K7401Z-7/8    | 7314150384471 | 1  | 173 |
| K7401Z-9/16   | 7314150384488 | 1  | 173 |
| K7406M-10     | 7314151844479 | 1  | 173 |
| K7406M-13     | 7314151844486 | 1  | 173 |
| K7406M-17     | 7314151844493 | 1  | 173 |
| K7760C-1      | 7314151222369 | 1  | 174 |
| K7760C-2      | 7314151222376 | 1  | 174 |
| K7764D        | 7314151222475 | 1  | 177 |
| K7767S        | 7314151222512 | 1  | 174 |
| K7800M-10     | 7314150326297 | 1  | 175 |
| K7800M-11     | 7314150326303 | 1  | 175 |
| K7800M-12     | 7314150326310 | 1  | 175 |
| K7800M-13     | 7314150326327 | 1  | 175 |
| K7800M-14     | 7314150326334 | 1  | 175 |
| K7800M-15     | 7314150326341 | 1  | 175 |
| K7800M-16     | 7314150326358 | 1  | 175 |
| K7800M-17     | 7314150326365 | 1  | 175 |
| K7800M-18     | 7314150326372 | 1  | 175 |
| K7800M-19     | 7314150326389 | 1  | 175 |
| K7800M-21     | 7314150326396 | 1  | 175 |
| K7800M-22     | 7314150326402 | 1  | 175 |
| K7800M-24     | 7314150326419 | 1  | 175 |
| K7800M/13     | 7314150437221 | 1  | 178 |
| K7801M-10     | 7314151778576 | 1  | 175 |
| K7801M-11     | 7314151778651 | 1  | 175 |
| K7801M-12     | 7314151815790 | 1  | 175 |
| K7801M-13     | 7314151778736 | 1  | 175 |
| K7801M-14     | 7314151778811 | 1  | 175 |
| K7801M-15     | 7314151815806 | 1  | 175 |
| K7801M-16     | 7314151779030 | 1  | 175 |
| K7801M-17     | 7314151779115 | 1  | 175 |
| K7801M-18     | 7314151779382 | 1  | 175 |
| K7801M-19     | 7314151779467 | 1  | 175 |
| K7801M-20     | 7314151844509 | 1  | 175 |
| K7801M-21     | 7314151779542 | 1  | 175 |
| K7801M-22     | 7314151779627 | 1  | 175 |
| K7801M-23     | 7314151844516 | 1  | 175 |
| K7801M-24     | 7314151779894 | 1  | 175 |
| K7801M-25     | 7314151844523 | 1  | 175 |
| K7801M-26     | 7314151844530 | 1  | 175 |
| K7801M-27     | 7314151779979 | 1  | 175 |
| K7801M-28     | 7314150430154 | 1  | 175 |
| K7801M-29     | 7314150430161 | 1  | 175 |
| K7801M-30     | 7314151811914 | 1  | 175 |
| K7801M-32     | 7314151825157 | 15 | 175 |
| K7801M-34     | 7314151844547 | 1  | 175 |
| K7801M-36     | 7314151844554 | 1  | 175 |
| K7801M-8      | 7314151845230 | 1  | 175 |
| K7801M-9      | 7314151845247 | 1  | 175 |
| K7801TORX-E10 | 7314151811587 | 1  | 177 |
| K7801TORX-E12 | 7314151811594 | 1  | 177 |
| K7801TORX-E14 | 7314151811600 | 1  | 177 |
| K7801TORX-E16 | 7314151811617 | 1  | 177 |
| K7801TORX-E18 | 7314151811624 | 1  | 177 |
| K7801TORX-E20 | 7314151811631 | 1  | 177 |
| K7801TORX-E24 | 7314151811648 | 1  | 177 |
| K7801VM-17    | 7314151781521 | 1  | 176 |
| K7801VM-19    | 7314151781798 | 1  | 176 |
| K7801VM-22    | 7314151781873 | 1  | 176 |
| K7801VM-24    | 7314151781958 | 1  | 176 |
| K7801VM/S4    | 7314151799090 | 1  | 178 |
| K7801Z-1      | 7314151844639 | 1  | 176 |
| K7801Z-1.1/16 | 7314151844646 | 1  | 176 |
| K7801Z-1.1/2  | 7314150137701 | 5  | 176 |
| K7801Z-1.1/4  | 7314151844660 | 1  | 176 |
| K7801Z-1.1/8  | 7314151844653 | 1  | 176 |
| K7801Z-1.3/8  | 7314150137688 | 5  | 176 |
| K7801Z-1.5/16 | 7314150137671 | 5  | 176 |
| K7801Z-1.7/16 | 7314150137695 | 5  | 176 |
| K7801Z-1/2    | 7314151822620 | 1  | 176 |
| K7801Z-11/16  | 7314151844592 | 1  | 176 |
| K7801Z-13/16  | 7314151844608 | 1  | 176 |
| K7801Z-15/16  | 7314151844622 | 1  | 176 |
| K7801Z-3/4    | 7314151822668 | 1  | 176 |
| K7801Z-3/8    | 7314151822606 | 1  | 176 |
| K7801Z-5/8    | 7314151844585 | 1  | 176 |
| K7801Z-7/16   | 7314151844561 | 1  | 176 |
| K7801Z-7/8    | 7314151844615 | 1  | 176 |
| K7801Z-9/16   | 7314151822637 | 1  | 176 |
| K7801Z/10     | 7314150165018 | 1  | 178 |
| K7806M-10     | 7314151844677 | 1  | 175 |
| K7806M-11     | 7314151844684 | 1  | 175 |
| K7806M-12     | 7314151844691 | 1  | 175 |
| K7806M-13     | 7314151805944 | 1  | 175 |
| K7806M-14     | 7314151844707 | 1  | 175 |
| K7806M-15     | 7314150330683 | 1  | 175 |
| K7806M-16     | 7314151844714 | 1  | 175 |
| K7806M-17     | 7314151805951 | 1  | 175 |
| K7806M-18     | 7314151844721 | 1  | 175 |
| K7806M-19     | 7314151805968 | 1  | 175 |
| K7806M-21     | 7314151823597 | 1  | 175 |
| K7806M-22     | 7314151805975 | 1  | 175 |
| K7806M-23     | 7314151844738 | 1  | 175 |
| K7806M-24     | 7314151805982 | 1  | 175 |
| K7806M-27     | 7314151805999 | 1  | 175 |



# K7806M-30



|                |               |    |     |
|----------------|---------------|----|-----|
| K7806M-30      | 7314151844578 | 1  | 175 |
| K7806M-32      | 7314150220304 | 1  | 175 |
| K7806M-36      | 7314150220311 | 1  | 175 |
| K7806M/S4      | 7314151813222 | 1  | 178 |
| K7806Z-1       | 7314150137817 | 5  | 176 |
| K7806Z-1.1/16  | 7314150137824 | 5  | 176 |
| K7806Z-1.1/2   | 7314150137886 | 5  | 176 |
| K7806Z-1.1/4   | 7314150137848 | 5  | 176 |
| K7806Z-1.1/8   | 7314150137831 | 5  | 176 |
| K7806Z-1.3/8   | 7314150137862 | 5  | 176 |
| K7806Z-1.5/16  | 7314150137855 | 5  | 176 |
| K7806Z-1.7/16  | 7314150137879 | 5  | 176 |
| K7806Z-1/2     | 7314150137749 | 10 | 176 |
| K7806Z-11/16   | 7314150137770 | 5  | 176 |
| K7806Z-13/16   | 7314150137794 | 5  | 176 |
| K7806Z-15/16   | 7314150137718 | 5  | 176 |
| K7806Z-3/4     | 7314150137787 | 5  | 176 |
| K7806Z-3/8     | 7314150137725 | 10 | 176 |
| K7806Z-5/8     | 7314150137763 | 5  | 176 |
| K7806Z-7/16    | 7314150137732 | 5  | 176 |
| K7806Z-7/8     | 7314150137800 | 5  | 176 |
| K7806Z-9/16    | 7314150137756 | 10 | 176 |
| K7806Z/10      | 7314150165025 | 1  | 177 |
| K8160D-1       | 7314151237400 | 1  | 177 |
| K8160D-2       | 7314151237417 | 1  | 177 |
| K8160D-3       | 7314151237424 | 1  | 177 |
| K8164C         | 7314151237523 | 1  | 174 |
| K8164F         | 7314151237554 | 1  | 180 |
| K8167S         | 7314151237592 | 1  | 177 |
| K8901M-17      | 7314151803155 | 1  | 179 |
| K8901M-18      | 7314151844189 | 1  | 179 |
| K8901M-19      | 7314151803162 | 1  | 179 |
| K8901M-21      | 7314151803179 | 1  | 179 |
| K8901M-22      | 7314151803186 | 1  | 179 |
| K8901M-23      | 7314151803193 | 1  | 179 |
| K8901M-24      | 7314151803209 | 1  | 179 |
| K8901M-27      | 7314151803216 | 1  | 179 |
| K8901M-28      | 7314151803223 | 1  | 179 |
| K8901M-29      | 7314151803230 | 1  | 179 |
| K8901M-30      | 7314151803247 | 1  | 179 |
| K8901M-32      | 7314151803254 | 1  | 179 |
| K8901M-33      | 7314151803261 | 1  | 179 |
| K8901M-34      | 7314151803278 | 1  | 179 |
| K8901M-36      | 7314151803285 | 1  | 179 |
| K8901M-38      | 7314151803292 | 1  | 179 |
| K8901M-41      | 7314151803308 | 1  | 179 |
| K8901M-46      | 7314151803315 | 1  | 179 |
| K8901M-50      | 7314151846398 | 1  | 179 |
| K8901M-55      | 7314151846404 | 1  | 179 |
| K8901M-60      | 7314151846411 | 1  | 179 |
| K8901M/8       | 7314150165032 | 1  | 181 |
| K8901Z-1       | 7314151844752 | 1  | 180 |
| K8901Z-1.1/16  | 7314151844769 | 1  | 180 |
| K8901Z-1.1/2   | 7314151844820 | 1  | 180 |
| K8901Z-1.1/4   | 7314151844783 | 1  | 180 |
| K8901Z-1.1/8   | 7314151844776 | 1  | 180 |
| K8901Z-1.11/16 | 7314150130269 | 1  | 180 |
| K8901Z-1.13/16 | 7314150130276 | 1  | 180 |
| K8901Z-1.15/16 | 7314150130290 | 1  | 180 |
| K8901Z-1.3/16  | 7314150130245 | 1  | 180 |
| K8901Z-1.3/4   | 7314151844844 | 1  | 180 |
| K8901Z-1.3/8   | 7314151844806 | 1  | 180 |
| K8901Z-1.5/16  | 7314151844790 | 1  | 180 |
| K8901Z-1.5/8   | 7314151844837 | 1  | 180 |
| K8901Z-1.7/16  | 7314151844813 | 1  | 180 |
| K8901Z-1.7/8   | 7314150130283 | 1  | 180 |
| K8901Z-1.9/16  | 7314150130252 | 1  | 180 |
| K8901Z-11/16   | 7314150130238 | 1  | 180 |
| K8901Z-13/16   | 7314151844226 | 1  | 180 |
| K8901Z-15/16   | 7314151844745 | 1  | 180 |
| K8901Z-2       | 7314150130306 | 1  | 180 |
| K8901Z-2.1/16  | 7314150130313 | 1  | 180 |
| K8901Z-2.1/4   | 7314150130344 | 1  | 180 |
| K8901Z-2.3/16  | 7314150130337 | 1  | 180 |
| K8901Z-2.3/8   | 7314150130351 | 1  | 180 |
| K8901Z-3/4     | 7314151844202 | 1  | 180 |
| K8901Z-7/8     | 7314151844301 | 1  | 180 |
| K8901Z/18      | 7314150436514 | 1  | 181 |
| K8901Z/8       | 7314150165049 | 1  | 181 |
| K8906M-17      | 7314151803056 | 1  | 179 |
| K8906M-19      | 7314151803063 | 1  | 179 |
| K8906M-21      | 7314151844851 | 1  | 179 |
| K8906M-22      | 7314151803070 | 1  | 179 |
| K8906M-24      | 7314151803087 | 1  | 179 |
| K8906M-27      | 7314151803094 | 1  | 179 |
| K8906M-30      | 7314151803117 | 1  | 179 |
| K8906M-32      | 7314151803124 | 1  | 179 |
| K8906M-33      | 7314151844868 | 1  | 179 |
| K8906M-34      | 7314151844875 | 1  | 179 |
| K8906M-36      | 7314151803148 | 1  | 179 |
| K8906M-41      | 7314151845254 | 1  | 179 |
| K8906M-42      | 7314150512607 | 1  | 179 |
| K8906M-46      | 7314150220601 | 1  | 179 |
| K8906M/8       | 7314150165056 | 1  | 181 |
| K8906Z-1       | 7314150130436 | 1  | 180 |
| K8906Z-1.1/16  | 7314150130443 | 1  | 180 |



|                |               |   |     |
|----------------|---------------|---|-----|
| K8906Z-1.1/2   | 7314150130511 | 1 | 180 |
| K8906Z-1.1/4   | 7314150130474 | 1 | 180 |
| K8906Z-1.1/8   | 7314150130450 | 1 | 180 |
| K8906Z-1.3/4   | 7314150130559 | 1 | 180 |
| K8906Z-1.3/8   | 7314150130498 | 1 | 180 |
| K8906Z-1.5/16  | 7314150130481 | 1 | 180 |
| K8906Z-1.5/8   | 7314150130535 | 1 | 180 |
| K8906Z-1.7/16  | 7314150130504 | 1 | 180 |
| K8906Z-13/16   | 7314150130405 | 1 | 180 |
| K8906Z-15/16   | 7314150130429 | 1 | 180 |
| K8906Z-2       | 7314150130580 | 1 | 180 |
| K8906Z-3/4     | 7314150130399 | 1 | 180 |
| K8906Z-7/8     | 7314150130412 | 1 | 180 |
| K8906Z/8       | 7314150165063 | 1 | 181 |
| K8909H-5       | 7314151619343 | 1 | 180 |
| K8909ML-12     | 7314151232863 | 1 | 183 |
| K8909ML-14     | 7314151232870 | 1 | 183 |
| K8909ML-17     | 7314151232887 | 1 | 183 |
| K8960F-2       | 7314151268138 | 1 | 181 |
| K8960F-3       | 7314151268145 | 1 | 181 |
| K8960F-4       | 7314150220625 | 1 | 181 |
| K8964D         | 7314151268237 | 1 | 177 |
| K8964G         | 7314151268268 | 1 | 182 |
| K8967S         | 7314151268329 | 1 | 180 |
| K9501M-22      | 7314151844882 | 1 | 182 |
| K9501M-24      | 7314151802677 | 1 | 182 |
| K9501M-27      | 7314151802684 | 1 | 182 |
| K9501M-30      | 7314151802714 | 1 | 182 |
| K9501M-32      | 7314151802721 | 1 | 182 |
| K9501M-33      | 7314151802738 | 1 | 182 |
| K9501M-34      | 7314151802745 | 1 | 182 |
| K9501M-36      | 7314151802752 | 1 | 182 |
| K9501M-38      | 7314151802769 | 1 | 182 |
| K9501M-41      | 7314151802776 | 1 | 182 |
| K9501M-42      | 7314151802783 | 1 | 182 |
| K9501M-46      | 7314151802790 | 1 | 182 |
| K9501M-50      | 7314151802806 | 1 | 182 |
| K9501M-55      | 7314151802813 | 1 | 182 |
| K9501M-60      | 7314151802820 | 1 | 182 |
| K9501M-65      | 7314151802837 | 1 | 182 |
| K9501M-70      | 7314151802844 | 1 | 182 |
| K9501M-75      | 7314151802851 | 1 | 182 |
| K9501M-80      | 7314151802868 | 1 | 182 |
| K9501M-85      | 7314150352197 | 1 | 182 |
| K9501Z-1       | 7314151844912 | 1 | 182 |
| K9501Z-1.1/16  | 7314150130634 | 1 | 182 |
| K9501Z-1.1/2   | 7314151844943 | 1 | 182 |
| K9501Z-1.1/4   | 7314151844929 | 1 | 182 |
| K9501Z-1.1/8   | 7314150130641 | 1 | 182 |
| K9501Z-1.11/16 | 7314150130696 | 1 | 182 |
| K9501Z-1.13/16 | 7314151844967 | 1 | 182 |
| K9501Z-1.15/16 | 7314150130719 | 1 | 182 |
| K9501Z-1.3/16  | 7314150130658 | 1 | 182 |
| K9501Z-1.3/4   | 7314150130702 | 1 | 182 |
| K9501Z-1.3/8   | 7314150130672 | 1 | 182 |
| K9501Z-1.5/16  | 7314150130665 | 1 | 182 |
| K9501Z-1.5/8   | 7314151844950 | 1 | 182 |
| K9501Z-1.7/16  | 7314151844936 | 1 | 182 |
| K9501Z-1.7/8   | 7314151844974 | 1 | 182 |
| K9501Z-1.9/16  | 7314150130689 | 1 | 182 |
| K9501Z-2       | 7314150130726 | 1 | 182 |
| K9501Z-2.1/4   | 7314150130764 | 1 | 182 |
| K9501Z-2.1/8   | 7314150130740 | 1 | 182 |
| K9501Z-2.3/16  | 7314150130757 | 1 | 182 |
| K9501Z-2.3/4   | 7314150130832 | 1 | 182 |
| K9501Z-2.5/16  | 7314150130771 | 1 | 182 |
| K9501Z-2.9/16  | 7314150130801 | 1 | 182 |
| K9506M-22      | 7314151844998 | 1 | 182 |
| K9506M-24      | 7314151802530 | 1 | 182 |
| K9506M-27      | 7314151802547 | 1 | 182 |
| K9506M-30      | 7314151802554 | 1 | 182 |
| K9506M-32      | 7314151802561 | 1 | 182 |
| K9506M-33      | 7314151802578 | 1 | 182 |
| K9506M-34      | 7314151845018 | 1 | 182 |
| K9506M-36      | 7314151802585 | 1 | 182 |
| K9506M-38      | 7314151802592 | 1 | 182 |
| K9506M-41      | 7314151802608 | 1 | 182 |
| K9506M-46      | 7314151802615 | 1 | 182 |
| K9506M-50      | 7314151802622 | 1 | 182 |
| K9506M-55      | 7314151802639 | 1 | 182 |
| K9506M-60      | 7314151802646 | 1 | 182 |
| K9506Z-1       | 7314150131686 | 1 | 182 |
| K9506Z-1.1/16  | 7314150131693 | 1 | 182 |
| K9506Z-1.1/2   | 7314150131761 | 1 | 182 |
| K9506Z-1.1/4   | 7314150131723 | 1 | 182 |
| K9506Z-1.13/16 | 7314150131808 | 1 | 182 |
| K9506Z-1.3/16  | 7314150131716 | 1 | 182 |
| K9506Z-1.5/8   | 7314150131785 | 1 | 182 |
| K9506Z-1.7/16  | 7314150131754 | 1 | 182 |
| K9506Z-1.7/8   | 7314150131815 | 1 | 182 |
| K9509H5        | 7314151619428 | 1 | 182 |
| K9509ML-19     | 7314151618964 | 1 | 183 |
| K9509ML-22     | 7314151619183 | 1 | 183 |
| K9509ML-24     | 7314151619268 | 1 | 183 |
| K9560G-0       | 7314150240012 | 1 | 183 |
| K9560G-1       | 7314151285944 | 1 | 183 |





|                |               |   |     |
|----------------|---------------|---|-----|
| K9560G-2       | 7314151285951 | 1 | 183 |
| K9560G-3       | 7314151285968 | 1 | 183 |
| K9560G-4       | 7314150133970 | 1 | 183 |
| K9560G-5       | 7314150133987 | 1 | 183 |
| K9564F         | 7314151286026 | 1 | 180 |
| K9567S         | 7314151286095 | 1 | 183 |
| K9598H         | 7314150133956 | 1 | 184 |
| K9801M-100     | 7314151845162 | 1 | 183 |
| K9801M-105     | 7314151845179 | 1 | 183 |
| K9801M-110     | 7314151845186 | 1 | 183 |
| K9801M-115     | 7314151845193 | 1 | 183 |
| K9801M-120     | 7314151845209 | 1 | 183 |
| K9801M-125     | 7314150167159 | 1 | 183 |
| K9801M-130     | 7314150167166 | 1 | 183 |
| K9801M-135     | 7314150167173 | 1 | 183 |
| K9801M-140     | 7314150167180 | 1 | 183 |
| K9801M-145     | 7314150167197 | 1 | 183 |
| K9801M-150     | 7314150167203 | 1 | 183 |
| K9801M-155     | 7314150167210 | 1 | 183 |
| K9801M-46      | 7314151845056 | 1 | 183 |
| K9801M-50      | 7314151845063 | 1 | 183 |
| K9801M-55      | 7314151845070 | 1 | 183 |
| K9801M-60      | 7314151845087 | 1 | 183 |
| K9801M-65      | 7314151845094 | 1 | 183 |
| K9801M-70      | 7314151845100 | 1 | 183 |
| K9801M-75      | 7314151845117 | 1 | 183 |
| K9801M-80      | 7314151845124 | 1 | 183 |
| K9801M-85      | 7314151845131 | 1 | 183 |
| K9801M-90      | 7314151845148 | 1 | 183 |
| K9801M-95      | 7314151845155 | 1 | 183 |
| K9801Z-1.1/2   | 7314150131976 | 1 | 184 |
| K9801Z-1.11/16 | 7314150132003 | 1 | 184 |
| K9801Z-1.13/16 | 7314150132027 | 1 | 184 |
| K9801Z-1.15/16 | 7314150132041 | 1 | 184 |
| K9801Z-1.3/4   | 7314150132010 | 1 | 184 |
| K9801Z-1.3/8   | 7314150131952 | 1 | 184 |
| K9801Z-1.5/8   | 7314150131990 | 1 | 184 |
| K9801Z-1.7/16  | 7314150131969 | 1 | 184 |
| K9801Z-1.7/8   | 7314150132034 | 1 | 184 |
| K9801Z-1.9/16  | 7314150131983 | 1 | 184 |
| K9801Z-2       | 7314150132058 | 1 | 184 |
| K9801Z-2.1/16  | 7314150132065 | 1 | 184 |
| K9801Z-2.1/2   | 7314150132133 | 1 | 184 |
| K9801Z-2.1/4   | 7314150132096 | 1 | 184 |
| K9801Z-2.1/8   | 7314150132072 | 1 | 184 |
| K9801Z-2.11/16 | 7314150132164 | 1 | 184 |
| K9801Z-2.13/16 | 7314150132188 | 1 | 184 |
| K9801Z-2.15/16 | 7314150132201 | 1 | 184 |
| K9801Z-2.3/16  | 7314150132089 | 1 | 184 |
| K9801Z-2.3/4   | 7314150132171 | 1 | 184 |
| K9801Z-2.3/8   | 7314150132119 | 1 | 184 |
| K9801Z-2.5/16  | 7314150132102 | 1 | 184 |
| K9801Z-2.5/8   | 7314150132157 | 1 | 184 |
| K9801Z-2.7/16  | 7314150132126 | 1 | 184 |
| K9801Z-2.7/8   | 7314150132195 | 1 | 184 |
| K9801Z-2.9/16  | 7314150132140 | 1 | 184 |
| K9801Z-3       | 7314150132218 | 1 | 184 |
| K9801Z-3.1/16  | 7314150132225 | 1 | 184 |
| K9801Z-3.1/2   | 7314150132287 | 1 | 184 |
| K9801Z-3.1/4   | 7314150132249 | 1 | 184 |
| K9801Z-3.1/8   | 7314150132232 | 1 | 184 |
| K9801Z-3.11/16 | 7314150132317 | 1 | 184 |
| K9801Z-3.13/16 | 7314150132331 | 1 | 184 |
| K9801Z-3.15/16 | 7314150132355 | 1 | 184 |
| K9801Z-3.3/4   | 7314150132324 | 1 | 184 |
| K9801Z-3.3/8   | 7314150132263 | 1 | 184 |
| K9801Z-3.5/16  | 7314150132256 | 1 | 184 |
| K9801Z-3.5/8   | 7314150132300 | 1 | 184 |
| K9801Z-3.7/16  | 7314150132270 | 1 | 184 |
| K9801Z-3.7/8   | 7314150132348 | 1 | 184 |
| K9801Z-3.9/16  | 7314150132294 | 1 | 184 |
| K9801Z-4       | 7314150132362 | 1 | 184 |
| K9801Z-4.1/16  | 7314150132379 | 1 | 184 |
| K9801Z-4.1/2   | 7314150132430 | 1 | 184 |
| K9801Z-4.1/4   | 7314150132393 | 1 | 184 |
| K9801Z-4.1/8   | 7314150132386 | 1 | 184 |
| K9801Z-4.3/4   | 7314150132454 | 1 | 184 |
| K9801Z-4.3/8   | 7314150132416 | 1 | 184 |
| K9801Z-4.5/16  | 7314150132409 | 1 | 184 |
| K9801Z-4.5/8   | 7314150132447 | 1 | 184 |
| K9801Z-4.7/16  | 7314150132423 | 1 | 184 |
| K9806M-100     | 7314150131105 | 1 | 183 |
| K9806M-105     | 7314150131112 | 1 | 183 |
| K9806M-110     | 7314150131129 | 1 | 183 |
| K9806M-115     | 7314150131136 | 1 | 183 |
| K9806M-120     | 7314150131143 | 1 | 183 |
| K9806M-41      | 7314150130986 | 1 | 183 |
| K9806M-46      | 7314150130993 | 1 | 183 |
| K9806M-50      | 7314150131006 | 1 | 183 |
| K9806M-55      | 7314150131013 | 1 | 183 |
| K9806M-60      | 7314150131020 | 1 | 183 |
| K9806M-65      | 7314150131037 | 1 | 183 |
| K9806M-70      | 7314150131044 | 1 | 183 |
| K9806M-75      | 7314150131051 | 1 | 183 |
| K9806M-80      | 7314150131068 | 1 | 183 |
| K9806M-85      | 7314150131075 | 1 | 183 |



|                 |               |    |     |
|-----------------|---------------|----|-----|
| K9806M-90       | 7314150131082 | 1  | 183 |
| K9806M-95       | 7314150131099 | 1  | 183 |
| K9806Z-1.1/2    | 7314150131174 | 1  | 184 |
| K9806Z-1.11/16  | 7314150131198 | 1  | 184 |
| K9806Z-1.3/8    | 7314150131150 | 1  | 184 |
| K9806Z-1.5/8    | 7314150131181 | 1  | 184 |
| K9806Z-1.7/16   | 7314150131167 | 1  | 184 |
| K9806Z-2        | 7314150131204 | 1  | 184 |
| K9806Z-2.1/16   | 7314150131211 | 1  | 184 |
| K9806Z-2.1/2    | 7314150131273 | 1  | 184 |
| K9806Z-2.1/4    | 7314150131235 | 1  | 184 |
| K9806Z-2.11/16  | 7314150131303 | 1  | 184 |
| K9806Z-2.13/16  | 7314150131327 | 1  | 184 |
| K9806Z-2.15/16  | 7314150131341 | 1  | 184 |
| K9806Z-2.3/16   | 7314150131228 | 1  | 184 |
| K9806Z-2.3/4    | 7314150131310 | 1  | 184 |
| K9806Z-2.3/8    | 7314150131259 | 1  | 184 |
| K9806Z-2.5/16   | 7314150131242 | 1  | 184 |
| K9806Z-2.5/8    | 7314150131297 | 1  | 184 |
| K9806Z-2.7/16   | 7314150131266 | 1  | 184 |
| K9806Z-2.7/8    | 7314150131334 | 1  | 184 |
| K9806Z-2.9/16   | 7314150131280 | 1  | 184 |
| K9806Z-3        | 7314150131358 | 1  | 184 |
| K9806Z-3.1/16   | 7314150131365 | 1  | 184 |
| K9806Z-3.1/2    | 7314150131433 | 1  | 184 |
| K9806Z-3.1/4    | 7314150131396 | 1  | 184 |
| K9806Z-3.1/8    | 7314150131372 | 1  | 184 |
| K9806Z-3.11/16  | 7314150131464 | 1  | 184 |
| K9806Z-3.13/16  | 7314150131488 | 1  | 184 |
| K9806Z-3.15/16  | 7314150131501 | 1  | 184 |
| K9806Z-3.3/16   | 7314150131389 | 1  | 184 |
| K9806Z-3.3/4    | 7314150131471 | 1  | 184 |
| K9806Z-3.3/8    | 7314150131419 | 1  | 184 |
| K9806Z-3.5/16   | 7314150131402 | 1  | 184 |
| K9806Z-3.5/8    | 7314150131457 | 1  | 184 |
| K9806Z-3.7/16   | 7314150131426 | 1  | 184 |
| K9806Z-3.7/8    | 7314150131495 | 1  | 184 |
| K9806Z-3.9/16   | 7314150131440 | 1  | 184 |
| K9806Z-4        | 7314150131518 | 1  | 184 |
| K9806Z-4.1/16   | 7314150131525 | 1  | 184 |
| K9806Z-4.1/2    | 7314150131570 | 1  | 184 |
| K9806Z-4.1/4    | 7314150131549 | 1  | 184 |
| K9806Z-4.1/8    | 7314150131532 | 1  | 184 |
| K9806Z-4.3/4    | 7314150131594 | 1  | 184 |
| K9806Z-4.3/8    | 7314150131563 | 1  | 184 |
| K9806Z-4.5/16   | 7314150131556 | 1  | 184 |
| K9806Z-4.5/8    | 7314150131587 | 1  | 184 |
| K9860H-1        | 7314150133994 | 1  | 184 |
| K9860H-2        | 7314150134007 | 1  | 184 |
| K9860H-3        | 7314150134014 | 1  | 184 |
| K9867S          | 7314150133932 | 1  | 184 |
| K9895G          | 7314150133949 | 1  | 183 |
| K9899H          | 7314150166763 | 1  | 185 |
| K9998H          | 7314150133963 | 1  | 185 |
| KB09-01         | 7314150196968 | 5  | 581 |
| KB18-01         | 7314150196944 | 5  | 581 |
| KBFU-01         | 7314150196913 | 5  | 580 |
| KBGH-5P-DISPEN  | 7314150296729 | 20 | 581 |
| KBGR-5P-DISPEN  | 7314150296774 | 20 | 581 |
| KBGU-100P       | 7314150213405 | 1  | 581 |
| KBGU-10P-DISPEN | 7314150262984 | 20 | 581 |
| KBGU-5P-DISPEN  | 7314150296705 | 20 | 581 |
| KBRU-01         | 7314150196876 | 5  | 580 |
| KBSK-01         | 7314150196999 | 5  | 583 |
| KBSU-01         | 7314150197002 | 5  | 583 |
| KBTU-01         | 7314150196982 | 5  | 583 |
| KBWS-01         | 7314150225972 | 10 | 586 |
| KCB753          | 7314150204915 | 1  | 171 |
| KE18-01         | 7314150196937 | 5  | 580 |
| KEFU-01         | 7314150196906 | 5  | 580 |
| KERU-01         | 7314150196869 | 5  | 580 |
| KG09-01         | 7314150196975 | 5  | 581 |
| KG09-01-3P      | 7314150213962 | 10 | 581 |
| KG18-01         | 7314150196951 | 5  | 582 |
| KGAU-01         | 7314150223893 | 5  | 582 |
| KGFU-01         | 7314150196920 | 5  | 580 |
| KGRU-01         | 7314150196883 | 5  | 580 |
| KGRU-02         | 7314150196890 | 5  | 580 |
| KGSU-01         | 7314150197019 | 5  | 583 |
| KHU-01          | 7314150268955 | 4  | 582 |
| KM1/4-5/16-1P   | 7314150275953 | 1  | 172 |
| KM653-1P        | 7314151840709 | 1  | 171 |
| KM653-5P        | 7314150533565 | 1  | 171 |
| KM653-QR-1P     | 7314151848507 | 1  | 170 |
| KM653-QR-5P     | 7314150533589 | 1  | 170 |
| KM653-SF        | 7314150204984 | 1  | 171 |
| KM6701M-10      | 7314151844264 | 1  | 173 |
| KM6701M-7       | 7314151844240 | 1  | 173 |
| KM6701M-8       | 7314151844257 | 1  | 173 |
| KM6750-1/4      | 7314150204595 | 1  | 170 |
| KM6750-10-1P    | 7314150533626 | 1  | 170 |
| KM6750-11       | 7314150302628 | 1  | 170 |
| KM6750-13-1P    | 7314150533664 | 1  | 170 |
| KM6750-3/8      | 7314150204588 | 1  | 170 |
| KM6750-6        | 7314150204601 | 1  | 170 |
| KM6750-7        | 7314150204618 | 1  | 170 |



# KM753-QR-1P



|                    |               |     |     |
|--------------------|---------------|-----|-----|
| KM753-QR-1P        | 7314150204830 | 1   | 171 |
| KMR150             | 7314150204960 | 1   | 171 |
| KMR150-1P          | 7314150204977 | 1   | 171 |
| KMR653-5P          | 7314150533763 | 1   | 171 |
| KMR653-1P          | 7314150204939 | 1   | 171 |
| KMR753             | 7314150204946 | 1   | 171 |
| KMR753-1P          | 7314150204953 | 1   | 171 |
| KMT753-QR-1P       | 7314150391523 | 1   | 171 |
| KMU-01             | 7314150197026 | 5   | 580 |
| KR653              | 7314150204885 | 1   | 171 |
| KR653-1P           | 7314150260263 | 1   | 171 |
| KRSS-01            | 7314150214938 | 10  | 586 |
| KS7401M-10         | 7314150384495 | 1   | 174 |
| KS7401M-11         | 7314150384501 | 1   | 174 |
| KS7401M-12         | 7314150384518 | 1   | 174 |
| KS7401M-13         | 7314150384525 | 1   | 174 |
| KS7401M-14         | 7314150384532 | 1   | 174 |
| KS7401M-15         | 7314150384549 | 1   | 174 |
| KS7401M-16         | 7314150384556 | 1   | 174 |
| KS7401M-17         | 7314150384563 | 1   | 174 |
| KS7401M-18         | 7314150384570 | 1   | 174 |
| KS7401M-19         | 7314150384587 | 1   | 174 |
| KS7401M-22         | 7314150384594 | 1   | 174 |
| KS7401M-9          | 7314150384600 | 1   | 174 |
| KSBG09-10DISPEN    | 7314150262991 | 20  | 582 |
| KSBG18-10DISPEN    | 7314150263004 | 20  | 582 |
| KSR753             | 7314150204892 | 1   | 529 |
| KSR753-1P          | 7314150204908 | 1   | 529 |
| KUBG09-5P          | 7314150213450 | 20  | 582 |
| KUBG18-5DISPEN     | 7314150296835 | 20  | 582 |
| L1020I06           | 7314150501649 | 5   | 147 |
| L1020M06           | 7311518133665 | 1   | 145 |
| L1020M06X          | 7311518136369 | 1   | 145 |
| L1020S06           | 7314150501670 | 5   | 147 |
| L1225M06           | 7311518132774 | 1   | 145 |
| L1225M06X          | 7311518136857 | 1   | 145 |
| L1228I06           | 7314150501700 | 5   | 147 |
| L1228S06           | 7314150501731 | 5   | 147 |
| L1230AL06          | 7311518187668 | 1   | 146 |
| L1230AL08          | 7311518181871 | 1   | 146 |
| L1230M06           | 7311518182168 | 1   | 145 |
| L1230M06X          | 7311518182175 | 1   | 145 |
| L1630M06           | 7311518192914 | 1   | 145 |
| L1630M06X          | 7311518187446 | 1   | 145 |
| L1630M08           | 7311518182205 | 1   | 145 |
| L1630M08X          | 7311518136833 | 1   | 145 |
| LAP-KNIFE          | 7311518216443 | 10  | 635 |
| LARGE              | 7314150437429 | 1   | 375 |
| LS-6160-23         | 7311518041304 | 90  | 637 |
| LS-COIN 19 CM      | 7311518031077 | 4   | 601 |
| LS-COIN 26 CM      | 7311518333041 | 2   | 601 |
| LS-COMBINESS       | 7311518041366 | 600 | 636 |
| LS-MASSE-4         | 7311518012014 | 2   | 600 |
| LS-MASSE-4FG       | 7311518275891 | 2   | 600 |
| LS-MASSE-TR-4FG    | 7311518281106 | 2   | 601 |
| LS-MERLIN-2.5      | 7311518012069 | 2   | 601 |
| LS-MERLIN-2.5FG    | 7311518281113 | 2   | 601 |
| LS-PIERRE CORINDON | 7311518009977 | 1   | 636 |
| LS-PIERRE-FAUX     | 7311518009038 | 90  | 637 |
| LT-STEEL-30        | 7314150138012 | 5   | 539 |
| LT-STEEL-50        | 7314150138029 | 5   | 539 |
| LTB-10             | 7314150120048 | 6   | 539 |
| LTB-20             | 7314150120062 | 6   | 539 |
| LTB-30             | 7314150120086 | 6   | 539 |
| LTG-10             | 7314150119981 | 6   | 539 |
| LTG-20             | 7314150120000 | 6   | 539 |
| LTG-30             | 7314150120024 | 6   | 539 |
| LTS-100            | 7314150120147 | 5   | 539 |
| LTS-100-E          | 7314150120154 | 5   | 539 |
| LTS-30             | 7314150120109 | 5   | 539 |
| LTS-30-E           | 7314150120116 | 5   | 539 |
| LTS-50             | 7314150120123 | 5   | 539 |
| LTS-50-E           | 7314150120130 | 5   | 539 |
| LUB-2015           | 7311518335427 | 6   | 637 |
| M0310M03           | 7311518036805 | 1   | 145 |
| M0310M03X          | 7311518197063 | 1   | 145 |
| M0613M03X          | 7311518196622 | 1   | 145 |
| M0618M06           | 7311518036836 | 1   | 145 |
| M0618M06X          | 7311518036850 | 1   | 145 |
| M1022M06           | 7311518036881 | 1   | 145 |
| M1022M06X          | 7311518036904 | 1   | 145 |
| M1227M06           | 7311518036928 | 1   | 145 |
| M1227M06X          | 7311518036959 | 1   | 145 |
| M1227M08           | 7311518036980 | 1   | 145 |
| M1630M06           | 7311518193010 | 1   | 145 |
| M1630M06X          | 7311518187453 | 1   | 145 |
| M1630M08           | 7311518037062 | 1   | 145 |
| M1630M08X          | 7311518037086 | 1   | 145 |
| M227L              | 7311518160883 | 4   | 577 |
| M227R              | 7311518160869 | 4   | 578 |
| M330               | 7311518160906 | 4   | 578 |
| M526               | 7311518160982 | 4   | 578 |
| M6376              | 7311518196486 | 1   | 578 |
| M6376-SH           | 7311518199296 | 1   | 578 |
| M676               | 7311518161088 | 1   | 578 |
| M676-SH            | 7311518211875 | 1   | 578 |



|               |                |    |     |
|---------------|----------------|----|-----|
| M780          | 7314151826215  | 1  | 219 |
| M781          | 7314153016218  | 5  | 219 |
| M926          | 7311518161071  | 1  | 579 |
| M926-SH       | 7314150107537  | 1  | 579 |
| MA225         | 7311518161057  | 4  | 576 |
| MA225L        | 7311518161033  | 4  | 576 |
| MA225R        | 7311518161040  | 4  | 576 |
| MA311         | 7314150181568  | 1  | 576 |
| MA321         | 7314150181551  | 10 | 576 |
| MA325         | 7311518161064  | 4  | 577 |
| MA351         | 7314150181582  | 10 | 577 |
| MA361         | 7314150181575  | 10 | 577 |
| MA401         | 7314150167593  | 10 | 576 |
| MA411         | 7314150167609  | 10 | 576 |
| MA421         | 7314150167616  | 10 | 576 |
| MA431         | 7314150181544  | 1  | 576 |
| MA500-1A      | 7314150458882  | 1  | 654 |
| MA500-2A      | 7314150458899  | 1  | 654 |
| MA500-3A      | 7314150456925  | 1  | 654 |
| MAM50M        | 7314150215300  | 1  | 115 |
| MCP-2.5-810   | 7311518124052  | 2  | 600 |
| MES-3.0-900   | 7311518123864  | 2  | 601 |
| MES-3.5-900   | 7311518123871  | 2  | 601 |
| MES-3.5-900FG | 7311518281120  | 2  | 601 |
| MK5           | 7314150224333  | 1  | 59  |
| MK9           | 7314150224326  | 1  | 60  |
| MONSTER       | 7314150437405  | 1  | 375 |
| MR227L        | 7311518161002  | 4  | 578 |
| MR227R        | 7311518160999  | 4  | 578 |
| MR340         | 7311518197537  | 2  | 577 |
| MT-TS-3       | 7314150194995  | 12 | 538 |
| MTB-3-16      | 7314150119066  | 6  | 538 |
| MTB-3-16-M    | 7314150119073  | 6  | 538 |
| MTB-3-16-M-E  | 7314150119141  | 6  | 538 |
| MTB-5-25      | 7314150119080  | 6  | 538 |
| MTB-5-25-C1   | 7314150119127  | 6  | 538 |
| MTB-5-25-M    | 7314150119097  | 6  | 538 |
| MTB-5-25-M-E  | 7314150119158  | 6  | 538 |
| MTB-8-25      | 7314150125418  | 6  | 538 |
| MTB-8-25-M    | 7314150127078  | 6  | 538 |
| MTB-8-25-M-E  | 7314150127085  | 6  | 538 |
| MTC-3-13      | 7314150321322  | 6  | 538 |
| MTC-3-13-C1   | 7314150330843  | 6  | 538 |
| MTC-5-16      | 7314150321339  | 6  | 538 |
| MTC-5-16-C1   | 7314150330850  | 6  | 538 |
| MTG-3-16      | 7314150118984  | 12 | 538 |
| MTG-3-16-E    | 7314150119028  | 12 | 538 |
| MTG-5-19      | 7314150118991  | 12 | 538 |
| MTG-5-19-E    | 7314150119035  | 12 | 538 |
| MTG-8-25      | 7314150303348  | 4  | 538 |
| MTG-8-25-E    | 73141503090809 | 4  | 538 |
| MTS-5-25      | 7314150119233  | 6  | 538 |
| MTS-5-25-E    | 7314150119271  | 6  | 538 |
| MTS-8-25      | 7314150119257  | 6  | 538 |
| MTS-8-25-E    | 7314150119295  | 6  | 538 |
| MTT051        | 7314150270521  | 6  | 586 |
| MTT121        | 7314150213290  | 8  | 586 |
| MTT151        | 7314150120703  | 6  | 586 |
| MW-150        | 7314150125685  | 2  | 539 |
| MW-250        | 7314150125678  | 2  | 539 |
| N0306M03      | 7311518182212  | 1  | 145 |
| N0306M03E     | 7311518182229  | 1  | 145 |
| N0607M06      | 7311518182236  | 1  | 145 |
| N1213M06      | 7311518134570  | 1  | 145 |
| N1213M06X     | 7311518237172  | 1  | 145 |
| N1613M06      | 7311518136000  | 1  | 145 |
| N1613M06X     | 7311518204525  | 1  | 145 |
| N1613M08      | 7311518182267  | 1  | 145 |
| NP-12-COM     | 7311518264277  | 4  | 560 |
| NP-12-TEN     | 7311518263959  | 10 | 564 |
| NP-12-VEN     | 7311518264260  | 10 | 564 |
| NP-16-U7/8-HP | 7311518241773  | 4  | 561 |
| NP-19-U7/8-HP | 7311518241452  | 10 | 561 |
| NP-22-F7/8-HP | 7311518035204  | 10 | 562 |
| NP-22-U7/8-HP | 7311518034399  | 10 | 561 |
| NS001-150     | 7314150316069  | 5  | 506 |
| NS001-200     | 7314150316076  | 5  | 506 |
| NS001-250     | 7314150316083  | 5  | 506 |
| NS001-300     | 7314150316090  | 5  | 506 |
| NS001-375     | 7314150325108  | 5  | 506 |
| NS001-450     | 7314150325115  | 3  | 506 |
| NS001-600     | 7314150325122  | 1  | 506 |
| NS001-900     | 7314150325139  | 1  | 506 |
| NS002-10      | 7314150284719  | 10 | 506 |
| NS002-11      | 7314150292592  | 5  | 506 |
| NS002-12      | 7314150292608  | 5  | 506 |
| NS002-13      | 7314150284726  | 10 | 506 |
| NS002-14      | 7314150284733  | 5  | 506 |
| NS002-15      | 7314150292615  | 5  | 506 |
| NS002-16      | 7314150292622  | 5  | 506 |
| NS002-17      | 7314150284740  | 10 | 506 |
| NS002-18      | 7314150292639  | 5  | 506 |
| NS002-19      | 7314150284757  | 10 | 506 |
| NS002-20      | 7314150292646  | 5  | 506 |
| NS002-21      | 7314150292653  | 5  | 506 |
| NS002-22      | 7314150292660  | 10 | 506 |





|            |               |    |     |
|------------|---------------|----|-----|
| NS002-23   | 7314150292677 | 5  | 506 |
| NS002-24   | 7314150292684 | 10 | 506 |
| NS002-25   | 7314150292691 | 5  | 506 |
| NS002-26   | 7314150292707 | 5  | 506 |
| NS002-27   | 7314150284764 | 5  | 506 |
| NS002-28   | 7314150292714 | 5  | 506 |
| NS002-29   | 7314150292721 | 10 | 506 |
| NS002-30   | 7314150292738 | 10 | 506 |
| NS002-31   | 7314150292745 | 5  | 506 |
| NS002-32   | 7314150284771 | 5  | 506 |
| NS002-33   | 7314150292752 | 5  | 506 |
| NS002-34   | 7314150292769 | 5  | 506 |
| NS002-35   | 7314150292776 | 5  | 506 |
| NS002-36   | 7314150284788 | 5  | 506 |
| NS002-38   | 7314150292783 | 5  | 506 |
| NS002-40   | 7314150292790 | 5  | 506 |
| NS002-41   | 7314150292806 | 5  | 506 |
| NS002-42   | 7314150292813 | 5  | 506 |
| NS002-46   | 7314150292820 | 5  | 506 |
| NS002-50   | 7314150292837 | 5  | 506 |
| NS002-52   | 7314150292844 | 5  | 506 |
| NS002-55   | 7314150292851 | 5  | 506 |
| NS002-6    | 7314150292554 | 5  | 506 |
| NS002-60   | 7314150292868 | 1  | 506 |
| NS002-65   | 7314150292875 | 1  | 506 |
| NS002-7    | 7314150292561 | 5  | 506 |
| NS002-70   | 7314150292882 | 1  | 506 |
| NS002-75   | 7314150292899 | 1  | 506 |
| NS002-8    | 7314150292578 | 5  | 506 |
| NS002-80   | 7314150292905 | 1  | 506 |
| NS002-9    | 7314150292585 | 5  | 506 |
| NS003-11   | 7314150306602 | 1  | 506 |
| NS003-12   | 7314150306619 | 1  | 506 |
| NS003-14   | 7314150306626 | 1  | 506 |
| NS003-16   | 7314150306633 | 1  | 506 |
| NS003-18   | 7314150320356 | 1  | 506 |
| NS003-20   | 7314150320363 | 1  | 506 |
| NS003-24   | 7314150320370 | 1  | 506 |
| NS003-28   | 7314150320387 | 1  | 506 |
| NS003-30   | 7314150320394 | 1  | 506 |
| NS003-8    | 7314150320349 | 1  | 506 |
| NS006-0607 | 7314150292912 | 1  | 507 |
| NS006-0608 | 7314150292929 | 1  | 507 |
| NS006-0708 | 7314150292936 | 1  | 507 |
| NS006-0709 | 7314150292943 | 1  | 507 |
| NS006-0809 | 7314150292967 | 1  | 507 |
| NS006-0810 | 7314150292950 | 1  | 507 |
| NS006-0910 | 7314150292974 | 1  | 507 |
| NS006-0911 | 7314150292981 | 1  | 507 |
| NS006-1011 | 7314150292998 | 1  | 507 |
| NS006-1012 | 7314150293001 | 1  | 507 |
| NS006-1013 | 7314150293018 | 1  | 507 |
| NS006-1014 | 7314150293025 | 1  | 507 |
| NS006-1113 | 7314150293032 | 1  | 507 |
| NS006-1114 | 7314150293049 | 1  | 507 |
| NS006-1213 | 7314150293056 | 1  | 507 |
| NS006-1214 | 7314150293063 | 1  | 507 |
| NS006-1315 | 7314150293070 | 1  | 507 |
| NS006-1415 | 7314150293087 | 1  | 507 |
| NS006-1416 | 7314150293094 | 1  | 507 |
| NS006-1417 | 7314150293100 | 1  | 507 |
| NS006-1617 | 7314150293117 | 1  | 507 |
| NS006-1618 | 7314150293124 | 1  | 507 |
| NS006-1719 | 7314150293131 | 1  | 507 |
| NS006-1722 | 7314150293148 | 1  | 507 |
| NS006-1819 | 7314150293155 | 1  | 507 |
| NS006-1820 | 7314150293162 | 1  | 507 |
| NS006-1920 | 7314150293179 | 1  | 507 |
| NS006-1922 | 7314150293186 | 1  | 507 |
| NS006-1924 | 7314150293193 | 1  | 507 |
| NS006-2022 | 7314150293209 | 1  | 507 |
| NS006-2122 | 7314150293216 | 1  | 507 |
| NS006-2123 | 7314150293223 | 1  | 507 |
| NS006-2223 | 7314150293230 | 1  | 507 |
| NS006-2224 | 7314150293247 | 1  | 507 |
| NS006-2227 | 7314150293254 | 1  | 507 |
| NS006-2326 | 7314150293261 | 1  | 507 |
| NS006-2425 | 7314150293278 | 1  | 507 |
| NS006-2426 | 7314150293285 | 1  | 507 |
| NS006-2427 | 7314150293292 | 1  | 507 |
| NS006-2430 | 7314150293308 | 1  | 507 |
| NS006-2528 | 7314150293315 | 1  | 507 |
| NS006-2629 | 7314150293322 | 1  | 507 |
| NS006-2729 | 7314150293339 | 1  | 507 |
| NS006-2730 | 7314150293346 | 1  | 507 |
| NS006-2732 | 7314150293353 | 1  | 507 |
| NS006-2830 | 7314150293360 | 1  | 507 |
| NS006-3031 | 7314150293377 | 1  | 507 |
| NS006-3032 | 7314150293384 | 1  | 507 |
| NS006-3034 | 7314150293391 | 1  | 507 |
| NS006-3036 | 7314150293407 | 1  | 507 |
| NS006-3234 | 7314150293414 | 1  | 507 |
| NS006-3235 | 7314150293421 | 1  | 507 |
| NS006-3236 | 7314150293438 | 1  | 507 |
| NS006-3335 | 7314150293445 | 1  | 507 |
| NS006-3436 | 7314150293452 | 1  | 507 |



|              |               |   |     |
|--------------|---------------|---|-----|
| NS006-3536   | 7314150293469 | 1 | 507 |
| NS006-3638   | 7314150293476 | 1 | 507 |
| NS006-3641   | 7314150293483 | 1 | 507 |
| NS006-3642   | 7314150293490 | 1 | 507 |
| NS006-4146   | 7314150293506 | 1 | 507 |
| NS006-4650   | 7314150293513 | 1 | 507 |
| NS006-5052   | 7314150293520 | 1 | 507 |
| NS006-5055   | 7314150293537 | 1 | 507 |
| NS006-5060   | 7314150293544 | 1 | 507 |
| NS006-5062   | 7314150293551 | 1 | 507 |
| NS006-5560   | 7314150293568 | 1 | 507 |
| NS006-6065   | 7314150293575 | 1 | 507 |
| NS006-6570   | 7314150293582 | 1 | 507 |
| NS010-0607   | 7314150293599 | 1 | 508 |
| NS010-0709   | 7314150293605 | 1 | 508 |
| NS010-0809   | 7314150293612 | 1 | 508 |
| NS010-0911   | 7314150293629 | 1 | 508 |
| NS010-1011   | 7314150293636 | 1 | 508 |
| NS010-1012   | 7314150293643 | 1 | 508 |
| NS010-1214   | 7314150293650 | 1 | 508 |
| NS010-1315   | 7314150293667 | 1 | 508 |
| NS010-1417   | 7314150293674 | 1 | 508 |
| NS010-1618   | 7314150293681 | 1 | 508 |
| NS010-1719   | 7314150293698 | 1 | 508 |
| NS010-1722   | 7314150293704 | 1 | 508 |
| NS010-1819   | 7314150293711 | 1 | 508 |
| NS010-1921   | 7314150293728 | 1 | 508 |
| NS010-1922   | 7314150293735 | 1 | 508 |
| NS010-2022   | 7314150293742 | 1 | 508 |
| NS010-2123   | 7314150293759 | 1 | 508 |
| NS010-2224   | 7314150293766 | 1 | 508 |
| NS010-2427   | 7314150293773 | 1 | 508 |
| NS010-2528   | 7314150293780 | 1 | 508 |
| NS010-2628   | 7314150293797 | 1 | 508 |
| NS010-2730   | 7314150293803 | 1 | 508 |
| NS010-2732   | 7314150293810 | 1 | 508 |
| NS010-3032   | 7314150293827 | 1 | 508 |
| NS010-3036   | 7314150293834 | 1 | 508 |
| NS010-3238   | 7314150293841 | 1 | 508 |
| NS010-3641   | 7314150293858 | 1 | 508 |
| NS010-4146   | 7314150293865 | 1 | 508 |
| NS010-4650   | 7314150293872 | 1 | 508 |
| NS011-0607   | 7314150317271 | 1 | 508 |
| NS011-0809   | 7314150317288 | 1 | 508 |
| NS011-1011   | 7314150317295 | 1 | 508 |
| NS011-1213   | 7314150317301 | 1 | 508 |
| NS011-1415   | 7314150317318 | 1 | 508 |
| NS011-1617   | 7314150317325 | 1 | 508 |
| NS011-1819   | 7314150317332 | 1 | 508 |
| NS011-2022   | 7314150317349 | 1 | 508 |
| NS011-2123   | 7314150317356 | 1 | 508 |
| NS011-2426   | 7314150317363 | 1 | 508 |
| NS011-2528   | 7314150317370 | 1 | 508 |
| NS011-2729   | 7314150317387 | 1 | 508 |
| NS011-3032   | 7314150317394 | 1 | 508 |
| NS041-12-50  | 7314150502547 | 1 | 524 |
| NS041-16-100 | 7314150502561 | 1 | 524 |
| NS041-16-200 | 7314150502332 | 1 | 524 |
| NS041-16-260 | 7314150502585 | 1 | 524 |
| NS041-24-670 | 7314150502608 | 1 | 524 |
| NS041-32-900 | 7314150502622 | 1 | 524 |
| NS041-8-25   | 7314150502646 | 1 | 524 |
| NS100-100    | 7314150294305 | 1 | 509 |
| NS100-105    | 7314150294312 | 1 | 509 |
| NS100-110    | 7314150294329 | 1 | 509 |
| NS100-115    | 7314150294336 | 1 | 509 |
| NS100-120    | 7314150294343 | 1 | 509 |
| NS100-17     | 7314150293889 | 1 | 508 |
| NS100-19     | 7314150293896 | 1 | 508 |
| NS100-22     | 7314150293902 | 1 | 508 |
| NS100-24     | 7314150293919 | 1 | 508 |
| NS100-25     | 7314150293926 | 1 | 508 |
| NS100-27     | 7314150293933 | 1 | 508 |
| NS100-28     | 7314150293940 | 1 | 508 |
| NS100-29     | 7314150293957 | 1 | 508 |
| NS100-30     | 7314150293964 | 1 | 508 |
| NS100-32     | 7314150293971 | 1 | 508 |
| NS100-33     | 7314150293988 | 1 | 508 |
| NS100-34     | 7314150293995 | 1 | 508 |
| NS100-35     | 7314150294008 | 1 | 508 |
| NS100-36     | 7314150294015 | 1 | 508 |
| NS100-37     | 7314150294022 | 1 | 508 |
| NS100-38     | 7314150294039 | 1 | 508 |
| NS100-41     | 7314150294046 | 1 | 508 |
| NS100-42     | 7314150294053 | 1 | 508 |
| NS100-45     | 7314150294060 | 1 | 509 |
| NS100-46     | 7314150294077 | 1 | 509 |
| NS100-47     | 7314150294084 | 1 | 509 |
| NS100-50     | 7314150294091 | 1 | 509 |
| NS100-52     | 7314150294107 | 1 | 509 |
| NS100-54     | 7314150294114 | 1 | 509 |
| NS100-55     | 7314150294121 | 1 | 509 |
| NS100-56     | 7314150294138 | 1 | 509 |
| NS100-58     | 7314150294145 | 1 | 509 |
| NS100-60     | 7314150294152 | 1 | 509 |
| NS100-63     | 7314150294169 | 1 | 509 |



# NS100-65



|           |               |   |     |
|-----------|---------------|---|-----|
| NS100-65  | 7314150294176 | 1 | 509 |
| NS100-67  | 7314150294183 | 1 | 509 |
| NS100-70  | 7314150294190 | 1 | 509 |
| NS100-71  | 7314150294206 | 1 | 509 |
| NS100-75  | 7314150294213 | 1 | 509 |
| NS100-77  | 7314150294220 | 1 | 509 |
| NS100-80  | 7314150294237 | 1 | 509 |
| NS100-82  | 7314150294244 | 1 | 509 |
| NS100-85  | 7314150294251 | 1 | 509 |
| NS100-88  | 7314150294268 | 1 | 509 |
| NS100-90  | 7314150294275 | 1 | 509 |
| NS100-94  | 7314150294282 | 1 | 509 |
| NS100-95  | 7314150294299 | 1 | 509 |
| NS104-100 | 7314150294947 | 1 | 509 |
| NS104-105 | 7314150294954 | 1 | 509 |
| NS104-110 | 7314150294961 | 1 | 509 |
| NS104-115 | 7314150294978 | 1 | 509 |
| NS104-120 | 7314150294985 | 1 | 509 |
| NS104-17  | 7314150294350 | 1 | 509 |
| NS104-19  | 7314150294367 | 1 | 509 |
| NS104-20  | 7314150294374 | 1 | 509 |
| NS104-22  | 7314150294381 | 1 | 509 |
| NS104-24  | 7314150284795 | 1 | 509 |
| NS104-25  | 7314150294398 | 1 | 509 |
| NS104-26  | 7314150294404 | 1 | 509 |
| NS104-27  | 7314150284801 | 1 | 509 |
| NS104-28  | 7314150294411 | 1 | 509 |
| NS104-29  | 7314150294428 | 1 | 509 |
| NS104-30  | 7314150284818 | 1 | 509 |
| NS104-31  | 7314150294435 | 1 | 509 |
| NS104-32  | 7314150284825 | 1 | 509 |
| NS104-33  | 7314150294442 | 1 | 509 |
| NS104-34  | 7314150294459 | 1 | 509 |
| NS104-35  | 7314150294466 | 1 | 509 |
| NS104-36  | 7314150284832 | 1 | 509 |
| NS104-37  | 7314150294473 | 1 | 509 |
| NS104-38  | 7314150294480 | 1 | 509 |
| NS104-39  | 7314150294497 | 1 | 509 |
| NS104-40  | 7314150294503 | 1 | 509 |
| NS104-41  | 7314150284849 | 1 | 509 |
| NS104-42  | 7314150294510 | 1 | 509 |
| NS104-43  | 7314150294527 | 1 | 509 |
| NS104-44  | 7314150294534 | 1 | 509 |
| NS104-45  | 7314150294541 | 1 | 509 |
| NS104-46  | 7314150284856 | 1 | 509 |
| NS104-47  | 7314150294558 | 1 | 509 |
| NS104-48  | 7314150294565 | 1 | 509 |
| NS104-49  | 7314150294572 | 1 | 509 |
| NS104-50  | 7314150284863 | 1 | 509 |
| NS104-51  | 7314150294589 | 1 | 509 |
| NS104-52  | 7314150294596 | 1 | 509 |
| NS104-53  | 7314150294602 | 1 | 509 |
| NS104-54  | 7314150294619 | 1 | 509 |
| NS104-55  | 7314150284870 | 1 | 509 |
| NS104-56  | 7314150294626 | 1 | 509 |
| NS104-57  | 7314150294633 | 1 | 509 |
| NS104-58  | 7314150294640 | 1 | 509 |
| NS104-59  | 7314150294657 | 1 | 509 |
| NS104-60  | 7314150284887 | 1 | 509 |
| NS104-61  | 7314150294664 | 1 | 509 |
| NS104-62  | 7314150294671 | 1 | 509 |
| NS104-63  | 7314150294688 | 1 | 509 |
| NS104-64  | 7314150294695 | 1 | 509 |
| NS104-65  | 7314150294701 | 1 | 509 |
| NS104-66  | 7314150294718 | 1 | 509 |
| NS104-67  | 7314150294725 | 1 | 509 |
| NS104-68  | 7314150294732 | 1 | 509 |
| NS104-69  | 7314150294749 | 1 | 509 |
| NS104-70  | 7314150284894 | 1 | 509 |
| NS104-71  | 7314150294756 | 1 | 509 |
| NS104-72  | 7314150294763 | 1 | 509 |
| NS104-73  | 7314150294770 | 1 | 509 |
| NS104-74  | 7314150294787 | 1 | 509 |
| NS104-75  | 7314150284900 | 1 | 509 |
| NS104-76  | 7314150294794 | 1 | 509 |
| NS104-77  | 7314150294800 | 1 | 509 |
| NS104-78  | 7314150294817 | 1 | 509 |
| NS104-79  | 7314150294824 | 1 | 509 |
| NS104-80  | 7314150284917 | 1 | 509 |
| NS104-81  | 7314150294831 | 1 | 509 |
| NS104-82  | 7314150294848 | 1 | 509 |
| NS104-83  | 7314150294855 | 1 | 509 |
| NS104-84  | 7314150294862 | 1 | 509 |
| NS104-85  | 7314150284924 | 1 | 509 |
| NS104-86  | 7314150294879 | 1 | 509 |
| NS104-87  | 7314150294886 | 1 | 509 |
| NS104-88  | 7314150294893 | 1 | 509 |
| NS104-89  | 7314150294909 | 1 | 509 |
| NS104-90  | 7314150284931 | 1 | 509 |
| NS104-92  | 7314150294916 | 1 | 509 |
| NS104-94  | 7314150294923 | 1 | 509 |
| NS104-95  | 7314150284948 | 1 | 509 |
| NS104-98  | 7314150294930 | 1 | 509 |
| NS106-100 | 7314150295418 | 1 | 510 |
| NS106-104 | 7314150295425 | 1 | 510 |
| NS106-108 | 7314150295432 | 1 | 510 |



|            |               |   |     |
|------------|---------------|---|-----|
| NS106-112  | 7314150295449 | 1 | 510 |
| NS106-114  | 7314150295456 | 1 | 510 |
| NS106-116  | 7314150295463 | 1 | 510 |
| NS106-120  | 7314150295470 | 1 | 510 |
| NS106-124  | 7314150295487 | 1 | 510 |
| NS106-126  | 7314150295494 | 1 | 510 |
| NS106-128  | 7314150295500 | 1 | 510 |
| NS106-132  | 7314150295517 | 1 | 510 |
| NS106-136  | 7314150295524 | 1 | 510 |
| NS106-138  | 7314150295531 | 1 | 510 |
| NS106-144  | 7314150295548 | 1 | 510 |
| NS106-146  | 7314150295555 | 1 | 510 |
| NS106-150  | 7314150295562 | 1 | 510 |
| NS106-156  | 7314150295579 | 1 | 510 |
| NS106-158  | 7314150295586 | 1 | 510 |
| NS106-20   | 7314150294992 | 1 | 510 |
| NS106-22   | 7314150295005 | 1 | 510 |
| NS106-24   | 7314150295012 | 1 | 510 |
| NS106-25   | 7314150295029 | 1 | 510 |
| NS106-26   | 7314150295036 | 1 | 510 |
| NS106-28   | 7314150295043 | 1 | 510 |
| NS106-30   | 7314150295050 | 1 | 510 |
| NS106-32   | 7314150295067 | 1 | 510 |
| NS106-34   | 7314150295074 | 1 | 510 |
| NS106-36   | 7314150295081 | 1 | 510 |
| NS106-38   | 7314150295098 | 1 | 510 |
| NS106-40   | 7314150295104 | 1 | 510 |
| NS106-42   | 7314150295111 | 1 | 510 |
| NS106-44   | 7314150295128 | 1 | 510 |
| NS106-45   | 7314150295135 | 1 | 510 |
| NS106-46   | 7314150295142 | 1 | 510 |
| NS106-48   | 7314150295159 | 1 | 510 |
| NS106-50   | 7314150295166 | 1 | 510 |
| NS106-52   | 7314150295173 | 1 | 510 |
| NS106-54   | 7314150295180 | 1 | 510 |
| NS106-56   | 7314150295197 | 1 | 510 |
| NS106-58   | 7314150295203 | 1 | 510 |
| NS106-60   | 7314150295210 | 1 | 510 |
| NS106-62   | 7314150295227 | 1 | 510 |
| NS106-64   | 7314150295234 | 1 | 510 |
| NS106-66   | 7314150295241 | 1 | 510 |
| NS106-68   | 7314150295258 | 1 | 510 |
| NS106-70   | 7314150295265 | 1 | 510 |
| NS106-71   | 7314150295272 | 1 | 510 |
| NS106-72   | 7314150295289 | 1 | 510 |
| NS106-74   | 7314150295296 | 1 | 510 |
| NS106-76   | 7314150295302 | 1 | 510 |
| NS106-78   | 7314150295319 | 1 | 510 |
| NS106-80   | 7314150295326 | 1 | 510 |
| NS106-82   | 7314150295333 | 1 | 510 |
| NS106-84   | 7314150295340 | 1 | 510 |
| NS106-88   | 7314150295357 | 1 | 510 |
| NS106-90   | 7314150295364 | 1 | 510 |
| NS106-92   | 7314150295371 | 1 | 510 |
| NS106-94   | 7314150295388 | 1 | 510 |
| NS106-96   | 7314150295395 | 1 | 510 |
| NS106-98   | 7314150295401 | 1 | 510 |
| NS200-1200 | 7314150295661 | 1 | 511 |
| NS200-200  | 7314150295593 | 1 | 511 |
| NS200-250  | 7314150295609 | 1 | 511 |
| NS200-300  | 7314150295616 | 1 | 511 |
| NS200-350  | 7314150295623 | 1 | 511 |
| NS200-450  | 7314150295630 | 1 | 511 |
| NS200-600  | 7314150295647 | 1 | 511 |
| NS200-900  | 7314150295654 | 1 | 511 |
| NS202-350  | 7314150299690 | 1 | 511 |
| NS203-200  | 7314150359509 | 1 | 511 |
| NS203-215  | 7314150359516 | 1 | 511 |
| NS203-290  | 7314150359523 | 1 | 511 |
| NS203-400  | 7314150359530 | 1 | 511 |
| NS203-490  | 7314150359547 | 1 | 511 |
| NS203-800  | 7314150359554 | 1 | 511 |
| NS204-30   | 7314150295685 | 1 | 511 |
| NS204-32   | 7314150295692 | 1 | 511 |
| NS204-35   | 7314150295708 | 1 | 511 |
| NS204-40   | 7314150295715 | 1 | 511 |
| NS204-45   | 7314150295722 | 1 | 511 |
| NS204-48   | 7314150295739 | 1 | 511 |
| NS204-50   | 7314150295746 | 1 | 511 |
| NS204-55   | 7314150295753 | 1 | 511 |
| NS204-60   | 7314150295760 | 1 | 511 |
| NS204-65   | 7314150295777 | 1 | 511 |
| NS204-70   | 7314150295784 | 1 | 511 |
| NS204-75   | 7314150295791 | 1 | 511 |
| NS204-80   | 7314150295807 | 1 | 511 |
| NS204-85   | 7314150295814 | 1 | 511 |
| NS204-90   | 7314150295821 | 1 | 511 |
| NS220-06   | 7314150347216 | 1 | 512 |
| NS220-07   | 7314150347223 | 1 | 512 |
| NS220-08   | 7314150347230 | 1 | 512 |
| NS220-09   | 7314150347247 | 1 | 512 |
| NS220-10   | 7314150347254 | 1 | 512 |
| NS220-11   | 7314150347261 | 1 | 512 |
| NS220-12   | 7314150347278 | 1 | 512 |
| NS220-13   | 7314150347285 | 1 | 512 |
| NS220-14   | 7314150347292 | 1 | 512 |



|               |               |   |     |
|---------------|---------------|---|-----|
| NS220-15      | 7314150347308 | 1 | 512 |
| NS220-16      | 7314150347315 | 1 | 512 |
| NS220-17      | 7314150347322 | 1 | 512 |
| NS220-18      | 7314150347339 | 1 | 512 |
| NS220-19      | 7314150347346 | 1 | 512 |
| NS220-20      | 7314150347353 | 1 | 512 |
| NS220-21      | 7314150347360 | 1 | 512 |
| NS220-22      | 7314150347377 | 1 | 512 |
| NS220-23      | 7314150347384 | 1 | 512 |
| NS220-24      | 7314150347391 | 1 | 512 |
| NS220-25      | 7314150347407 | 1 | 512 |
| NS220-26      | 7314150347414 | 1 | 512 |
| NS220-27      | 7314150347421 | 1 | 512 |
| NS220-28      | 7314150347438 | 1 | 512 |
| NS220-29      | 7314150347445 | 1 | 512 |
| NS220-30      | 7314150347452 | 1 | 512 |
| NS220-32      | 7314150347469 | 1 | 512 |
| NS220-34      | 7314150347476 | 1 | 512 |
| NS220-36      | 7314150347483 | 1 | 512 |
| NS220-41      | 7314150347490 | 1 | 512 |
| NS224-17      | 7314150355525 | 1 | 512 |
| NS224-18      | 7314150355532 | 1 | 512 |
| NS224-19      | 7314150355549 | 1 | 512 |
| NS224-21      | 7314150355556 | 1 | 512 |
| NS224-22      | 7314150355563 | 1 | 512 |
| NS224-23      | 7314150355570 | 1 | 512 |
| NS224-24      | 7314150355587 | 1 | 512 |
| NS224-26      | 7314150355594 | 1 | 512 |
| NS224-27      | 7314150355617 | 1 | 512 |
| NS224-28      | 7314150355624 | 1 | 512 |
| NS224-29      | 7314150355631 | 1 | 512 |
| NS224-30      | 7314150355648 | 1 | 512 |
| NS224-32      | 7314150355655 | 1 | 512 |
| NS224-34      | 7314150355662 | 1 | 512 |
| NS224-36      | 7314150355679 | 1 | 512 |
| NS224-38      | 7314150355686 | 1 | 512 |
| NS224-41      | 7314150355693 | 1 | 512 |
| NS224-46      | 7314150355709 | 1 | 512 |
| NS224-50      | 7314150355716 | 1 | 512 |
| NS228-22      | 7314150355914 | 1 | 513 |
| NS228-24      | 7314150355921 | 1 | 513 |
| NS228-26      | 7314150355938 | 1 | 513 |
| NS228-27      | 7314150355945 | 1 | 513 |
| NS228-28      | 7314150355952 | 1 | 513 |
| NS228-29      | 7314150355969 | 1 | 513 |
| NS228-30      | 7314150355976 | 1 | 513 |
| NS228-31      | 7314150355983 | 1 | 513 |
| NS228-32      | 7314150355990 | 1 | 513 |
| NS228-34      | 7314150356003 | 1 | 513 |
| NS228-36      | 7314150356010 | 1 | 513 |
| NS228-38      | 7314150356027 | 1 | 513 |
| NS228-41      | 7314150356034 | 1 | 513 |
| NS228-46      | 7314150356041 | 1 | 513 |
| NS228-50      | 7314150356058 | 1 | 513 |
| NS228-55      | 7314150356065 | 1 | 513 |
| NS228-60      | 7314150356072 | 1 | 513 |
| NS228-65      | 7314150356089 | 1 | 513 |
| NS228-70      | 7314150356096 | 1 | 513 |
| NS228-75      | 7314150356102 | 1 | 513 |
| NS228-80      | 7314150356119 | 1 | 513 |
| NS232-16-24   | 7314150356331 | 1 | 513 |
| NS232-24-16   | 7314150356355 | 1 | 513 |
| NS232-24-32   | 7314150356348 | 1 | 513 |
| NS232-32-24   | 7314150356362 | 1 | 513 |
| NS234-16-100  | 7314150356416 | 1 | 513 |
| NS234-16-200  | 7314150356423 | 1 | 513 |
| NS234-16-250  | 7314150356430 | 1 | 513 |
| NS234-24-200  | 7314150356447 | 1 | 513 |
| NS234-32-250  | 7314150356454 | 1 | 513 |
| NS236-16      | 7314150356522 | 1 | 513 |
| NS236-24      | 7314150356539 | 1 | 513 |
| NS236-32      | 7314150356515 | 1 | 513 |
| NS238-16-250  | 7314150356577 | 1 | 514 |
| NS238-24-250  | 7314150356584 | 1 | 514 |
| NS238-32-300  | 7314150356591 | 1 | 514 |
| NS240-16-230  | 7314150356737 | 1 | 514 |
| NS242-16      | 7314150356638 | 1 | 514 |
| NS242-24      | 7314150356645 | 1 | 514 |
| NS242-32      | 7314150356652 | 1 | 514 |
| NS243-16-400  | 7314150356690 | 1 | 514 |
| NS247-26      | 7314150356751 | 1 | 515 |
| NS248-16-52   | 7314150356713 | 1 | 515 |
| NS300-10-200  | 7314150317783 | 1 | 515 |
| NS300-10-300  | 7314150316205 | 1 | 515 |
| NS300-11-250  | 7314150317790 | 1 | 515 |
| NS300-11-300  | 7314150317806 | 1 | 515 |
| NS300-11-350  | 7314150316212 | 1 | 515 |
| NS300-12-400  | 7314150325153 | 1 | 515 |
| NS300-13-450  | 7314150325160 | 1 | 515 |
| NS300-3-50    | 7314150317677 | 1 | 515 |
| NS300-3-75    | 7314150317684 | 1 | 515 |
| NS300-4-75    | 7314150317691 | 1 | 515 |
| NS300-4.5-100 | 7314150316175 | 1 | 515 |
| NS300-4.5-50  | 7314150317707 | 1 | 515 |
| NS300-5-100   | 7314150317721 | 1 | 515 |
| NS300-5-75    | 7314150317714 | 1 | 515 |



|                |               |   |     |
|----------------|---------------|---|-----|
| NS300-6-100    | 7314150316182 | 1 | 515 |
| NS300-6-125    | 7314150317738 | 1 | 515 |
| NS300-6-150    | 7314150317745 | 1 | 515 |
| NS300-7-150    | 7314150317752 | 1 | 515 |
| NS300-8-150    | 7314150316199 | 1 | 515 |
| NS300-8-200    | 7314150317769 | 1 | 515 |
| NS300-9-250    | 7314150317776 | 1 | 515 |
| NS301-10-200   | 7314150317882 | 1 | 515 |
| NS301-10-300   | 7314150317899 | 1 | 515 |
| NS301-3-50     | 7314150317813 | 1 | 515 |
| NS301-4-100    | 7314150317820 | 1 | 515 |
| NS301-4-150    | 7314150317837 | 1 | 515 |
| NS301-5-100    | 7314150317844 | 1 | 515 |
| NS301-5-200    | 7314150317851 | 1 | 515 |
| NS301-6-100    | 7314150317868 | 1 | 515 |
| NS301-8-150    | 7314150317875 | 1 | 515 |
| NS302-0-50     | 7314150316229 | 1 | 516 |
| NS302-1-100    | 7314150316236 | 1 | 516 |
| NS302-2-125    | 7314150316243 | 1 | 516 |
| NS302-3-150    | 7314150316250 | 1 | 516 |
| NS302-4-300    | 7314150316267 | 1 | 516 |
| NS304-0-50     | 7314150316274 | 1 | 516 |
| NS304-1-100    | 7314150316281 | 1 | 516 |
| NS304-2-125    | 7314150316298 | 1 | 516 |
| NS304-3-150    | 7314150316304 | 1 | 516 |
| NS304-4-300    | 7314150316311 | 1 | 516 |
| NS320-10       | 7314150318162 | 1 | 516 |
| NS320-2        | 7314150318087 | 1 | 516 |
| NS320-3        | 7314150318094 | 1 | 516 |
| NS320-4        | 7314150318100 | 1 | 516 |
| NS320-5        | 7314150318117 | 1 | 516 |
| NS320-6        | 7314150318124 | 1 | 516 |
| NS320-7        | 7314150318131 | 1 | 516 |
| NS320-8        | 7314150318148 | 1 | 516 |
| NS320-9        | 7314150318155 | 1 | 516 |
| NS400-160      | 7314150316106 | 1 | 516 |
| NS400-180      | 7314150316113 | 1 | 516 |
| NS400-200      | 7314150316120 | 1 | 516 |
| NS402-160      | 7314150316137 | 1 | 517 |
| NS402-200      | 7314150325177 | 1 | 517 |
| NS403-160      | 7314150318209 | 1 | 517 |
| NS403-180      | 7314150318193 | 1 | 517 |
| NS404-160      | 7314150318216 | 1 | 517 |
| NS405-160      | 7314150318247 | 1 | 517 |
| NS406-160      | 7314150316144 | 1 | 517 |
| NS406-180      | 7314150318261 | 1 | 517 |
| NS406-200      | 7314150316151 | 1 | 517 |
| NS407-160      | 7314150318278 | 1 | 517 |
| NS408-250      | 7314150316168 | 1 | 518 |
| NS408-300      | 7314150318292 | 1 | 518 |
| NS411-200      | 7314150318322 | 1 | 518 |
| NS412-200      | 7314150318339 | 1 | 518 |
| NS413-180      | 7314150318384 | 1 | 518 |
| NS413-200      | 7314150318377 | 1 | 518 |
| NS500-1000-FB  | 7314150296019 | 1 | 519 |
| NS500-1500-FB  | 7314150296026 | 1 | 519 |
| NS500-2000     | 7314150291847 | 1 | 519 |
| NS500-2000-FB  | 7314150284955 | 1 | 519 |
| NS500-2500     | 7314150291854 | 1 | 518 |
| NS500-2500-FB  | 7314150284962 | 1 | 519 |
| NS500-3000     | 7314150291861 | 1 | 518 |
| NS500-3000-FB  | 7314150284979 | 1 | 519 |
| NS500-3500-FB  | 7314150284986 | 1 | 519 |
| NS500-4000     | 7314150291878 | 1 | 518 |
| NS502-1000-FB  | 7314150284993 | 1 | 519 |
| NS502-10000-FB | 7314150285068 | 1 | 519 |
| NS502-12000-FB | 7314150318407 | 1 | 519 |
| NS502-1500-FB  | 7314150318438 | 1 | 519 |
| NS502-2000-FB  | 7314150285006 | 1 | 519 |
| NS502-2500-FB  | 7314150285013 | 1 | 519 |
| NS502-3000-FB  | 7314150285020 | 1 | 519 |
| NS502-450-FB   | 7314150296033 | 1 | 519 |
| NS502-4500-FB  | 7314150285037 | 1 | 519 |
| NS502-5000-FB  | 7314150285044 | 1 | 519 |
| NS502-6800-FB  | 7314150318445 | 1 | 519 |
| NS502-8000-FB  | 7314150285051 | 1 | 519 |
| NS504-100-FB   | 7314150296040 | 1 | 519 |
| NS504-1000-FB  | 7314150285099 | 1 | 519 |
| NS504-1500-FB  | 7314150285105 | 1 | 519 |
| NS504-200-FB   | 7314150296057 | 1 | 519 |
| NS504-2000-FB  | 7314150285112 | 1 | 519 |
| NS504-300-FB   | 7314150296064 | 1 | 519 |
| NS504-500-FB   | 7314150285075 | 1 | 519 |
| NS504-800-FB   | 7314150285082 | 1 | 519 |
| NS506-300      | 7314150285129 | 1 | 519 |
| NS506-300-FB   | 7314150318469 | 1 | 520 |
| NS506-450      | 7314150285136 | 1 | 519 |
| NS506-450-FB   | 7314150318476 | 1 | 520 |
| NS506-700      | 7314150296071 | 1 | 519 |
| NS506-700-FB   | 7314150285143 | 1 | 520 |
| NS506-900      | 7314150296088 | 1 | 519 |
| NS506-900-FB   | 7314150285150 | 1 | 520 |
| NS508-500-FB   | 7314150318544 | 1 | 520 |
| NS508-700-FB   | 7314150318537 | 1 | 520 |
| NS512-200-FB   | 7314150318568 | 1 | 520 |
| NS512-400-FB   | 7314150318575 | 1 | 520 |





# NS512-600-FB



|              |               |    |     |
|--------------|---------------|----|-----|
| NS512-600-FB | 7314150318582 | 1  | 520 |
| NS512-900-FB | 7314150318599 | 1  | 520 |
| NS600-100-50 | 7314150296101 | 1  | 520 |
| NS600-135-50 | 7314150296118 | 1  | 520 |
| NS600-150-25 | 7314150296125 | 1  | 520 |
| NS600-150-30 | 7314150301676 | 1  | 520 |
| NS600-150-40 | 7314150296132 | 1  | 520 |
| NS600-150-50 | 7314150296149 | 1  | 520 |
| NS600-180-13 | 7314150296156 | 1  | 520 |
| NS600-180-32 | 7314150285167 | 1  | 520 |
| NS600-180-50 | 7314150285174 | 1  | 520 |
| NS600-200-20 | 7314150296163 | 1  | 520 |
| NS600-200-30 | 7314150296170 | 1  | 520 |
| NS600-200-40 | 7314150296187 | 1  | 520 |
| NS600-200-50 | 7314150301782 | 1  | 520 |
| NS600-230-40 | 7314150296194 | 1  | 520 |
| NS600-250-40 | 7314150296200 | 1  | 520 |
| NS600-300-50 | 7314150296217 | 1  | 520 |
| NS600-80-13  | 7314150296095 | 1  | 520 |
| NS602-460    | 7314150285181 | 1  | 521 |
| NS602-600    | 7314150285198 | 1  | 521 |
| NS602-760    | 7314150296224 | 1  | 521 |
| NS602-900    | 7314150296231 | 1  | 521 |
| NS604-150    | 7314150296248 | 1  | 521 |
| NS604-200    | 7314150285204 | 1  | 521 |
| NS604-300    | 7314150285211 | 1  | 521 |
| NS606-150    | 7314150285228 | 1  | 521 |
| NS606-200    | 7314150285235 | 1  | 521 |
| NS606-250    | 7314150285242 | 1  | 521 |
| NS606-300    | 7314150285259 | 1  | 521 |
| NS606-400    | 7314150285266 | 1  | 521 |
| NS608-100    | 7314150285273 | 1  | 521 |
| NS700-300    | 7314150325184 | 1  | 521 |
| NS702-200    | 7314150325191 | 1  | 522 |
| NS704-225    | 7314150325207 | 1  | 522 |
| NS706-50     | 7314150325214 | 1  | 522 |
| NS706-80     | 7314150325221 | 1  | 522 |
| NS708-360    | 7314150325238 | 1  | 522 |
| NS710-450    | 7314150325245 | 1  | 523 |
| NS800-1100   | 7314150296323 | 1  | 523 |
| NS800-1700   | 7314150285280 | 1  | 523 |
| NS800-2000   | 7314150296330 | 1  | 523 |
| NS802-290    | 7314150285297 | 1  | 523 |
| NS804-290    | 7314150296347 | 1  | 523 |
| NS810-100    | 7314150318728 | 1  | 523 |
| NS810-150    | 7314150318711 | 1  | 523 |
| NS810-200    | 7314150318704 | 1  | 523 |
| NS810-350    | 7314150318698 | 1  | 523 |
| NSB001-150   | 7314150292509 | 5  | 506 |
| NSB001-200   | 7314150284689 | 5  | 506 |
| NSB001-250   | 7314150284696 | 5  | 506 |
| NSB001-300   | 7314150284702 | 5  | 506 |
| NSB001-375   | 7314150292516 | 5  | 506 |
| NSB001-450   | 7314150292523 | 3  | 506 |
| NSB001-600   | 7314150292530 | 3  | 506 |
| NSB001-900   | 7314150292547 | 1  | 506 |
| NSB002-10    | 7314150316366 | 5  | 506 |
| NSB002-11    | 7314150316373 | 5  | 506 |
| NSB002-12    | 7314150316380 | 5  | 506 |
| NSB002-13    | 7314150316397 | 5  | 506 |
| NSB002-14    | 7314150316403 | 5  | 506 |
| NSB002-15    | 7314150316410 | 5  | 506 |
| NSB002-16    | 7314150316427 | 5  | 506 |
| NSB002-17    | 7314150316434 | 5  | 506 |
| NSB002-18    | 7314150316441 | 5  | 506 |
| NSB002-19    | 7314150316458 | 5  | 506 |
| NSB002-20    | 7314150316465 | 5  | 506 |
| NSB002-21    | 7314150316472 | 5  | 506 |
| NSB002-22    | 7314150316489 | 5  | 506 |
| NSB002-23    | 7314150316496 | 5  | 506 |
| NSB002-24    | 7314150316502 | 5  | 506 |
| NSB002-25    | 7314150316519 | 5  | 506 |
| NSB002-26    | 7314150316526 | 5  | 506 |
| NSB002-27    | 7314150316533 | 5  | 506 |
| NSB002-28    | 7314150316540 | 5  | 506 |
| NSB002-29    | 7314150316557 | 5  | 506 |
| NSB002-30    | 7314150316564 | 5  | 506 |
| NSB002-31    | 7314150321728 | 1  | 506 |
| NSB002-32    | 7314150316571 | 10 | 506 |
| NSB002-33    | 7314150321735 | 1  | 506 |
| NSB002-34    | 7314150321742 | 1  | 506 |
| NSB002-35    | 7314150321759 | 1  | 506 |
| NSB002-36    | 7314150321766 | 5  | 506 |
| NSB002-38    | 7314150321773 | 1  | 506 |
| NSB002-40    | 7314150321780 | 1  | 506 |
| NSB002-41    | 7314150321797 | 5  | 506 |
| NSB002-42    | 7314150321803 | 1  | 506 |
| NSB002-46    | 7314150321810 | 1  | 506 |
| NSB002-50    | 7314150321827 | 1  | 506 |
| NSB002-52    | 7314150321834 | 1  | 506 |
| NSB002-55    | 7314150321841 | 1  | 506 |
| NSB002-6     | 7314150316328 | 5  | 506 |
| NSB002-60    | 7314150321858 | 1  | 506 |
| NSB002-65    | 7314150321865 | 1  | 506 |
| NSB002-7     | 7314150316335 | 5  | 506 |
| NSB002-70    | 7314150321872 | 1  | 506 |



|             |               |   |     |
|-------------|---------------|---|-----|
| NSB002-75   | 7314150321889 | 1 | 506 |
| NSB002-8    | 7314150316342 | 5 | 506 |
| NSB002-80   | 7314150321896 | 1 | 506 |
| NSB002-9    | 7314150316359 | 5 | 506 |
| NSB003-10   | 7314150342709 | 1 | 506 |
| NSB003-11   | 7314150342716 | 1 | 506 |
| NSB003-12   | 7314150342723 | 5 | 506 |
| NSB003-13   | 7314150342730 | 1 | 507 |
| NSB003-14   | 7314150342747 | 1 | 507 |
| NSB003-16   | 7314150342754 | 5 | 507 |
| NSB003-18   | 7314150342761 | 1 | 507 |
| NSB003-19   | 7314150342778 | 1 | 507 |
| NSB003-20   | 7314150342785 | 1 | 507 |
| NSB003-22   | 7314150342792 | 5 | 507 |
| NSB003-24   | 7314150342808 | 5 | 507 |
| NSB003-25   | 7314150342815 | 1 | 507 |
| NSB003-26   | 7314150342822 | 1 | 507 |
| NSB003-28   | 7314150342839 | 5 | 507 |
| NSB003-30   | 7314150342846 | 1 | 507 |
| NSB003-31   | 7314150342853 | 1 | 507 |
| NSB003-32   | 7314150342860 | 1 | 507 |
| NSB003-34   | 7314150342877 | 1 | 507 |
| NSB003-36   | 7314150342884 | 1 | 507 |
| NSB003-38   | 7314150342891 | 1 | 507 |
| NSB003-40   | 7314150342907 | 1 | 507 |
| NSB003-42   | 7314150342914 | 1 | 507 |
| NSB003-44   | 7314150342921 | 5 | 507 |
| NSB003-46   | 7314150342938 | 1 | 507 |
| NSB003-48   | 7314150342945 | 1 | 507 |
| NSB003-50   | 7314150342952 | 1 | 507 |
| NSB003-52   | 7314150342969 | 1 | 507 |
| NSB003-54   | 7314150342976 | 1 | 507 |
| NSB003-56   | 7314150342983 | 1 | 507 |
| NSB003-58   | 7314150342990 | 1 | 507 |
| NSB003-60   | 7314150343010 | 1 | 507 |
| NSB003-62   | 7314150343027 | 1 | 507 |
| NSB003-64   | 7314150343034 | 5 | 507 |
| NSB003-68   | 7314150343041 | 1 | 507 |
| NSB003-72   | 7314150343058 | 1 | 507 |
| NSB003-8    | 7314150342693 | 1 | 506 |
| NSB003-80   | 7314150343065 | 1 | 507 |
| NSB003-84   | 7314150343072 | 1 | 507 |
| NSB003-88   | 7314150343089 | 1 | 507 |
| NSB006-0607 | 7314150316588 | 1 | 507 |
| NSB006-0608 | 7314150321926 | 1 | 507 |
| NSB006-0708 | 7314150321933 | 1 | 507 |
| NSB006-0709 | 7314150321940 | 1 | 507 |
| NSB006-0809 | 7314150316595 | 1 | 507 |
| NSB006-0810 | 7314150321957 | 1 | 507 |
| NSB006-0910 | 7314150321964 | 1 | 507 |
| NSB006-0911 | 7314150321971 | 1 | 507 |
| NSB006-1011 | 7314150316601 | 1 | 507 |
| NSB006-1012 | 7314150322015 | 1 | 507 |
| NSB006-1013 | 7314150322022 | 1 | 507 |
| NSB006-1014 | 7314150322039 | 1 | 507 |
| NSB006-1113 | 7314150322046 | 1 | 507 |
| NSB006-1114 | 7314150322053 | 1 | 507 |
| NSB006-1213 | 7314150316618 | 1 | 507 |
| NSB006-1214 | 7314150322060 | 1 | 507 |
| NSB006-1315 | 7314150322077 | 1 | 507 |
| NSB006-1415 | 7314150316625 | 1 | 507 |
| NSB006-1416 | 7314150322084 | 1 | 507 |
| NSB006-1417 | 7314150322091 | 1 | 507 |
| NSB006-1617 | 7314150316632 | 1 | 507 |
| NSB006-1618 | 7314150322107 | 1 | 507 |
| NSB006-1719 | 7314150322114 | 1 | 507 |
| NSB006-1722 | 7314150322121 | 1 | 507 |
| NSB006-1819 | 7314150316649 | 1 | 507 |
| NSB006-1820 | 7314150322138 | 1 | 507 |
| NSB006-1920 | 7314150322145 | 1 | 507 |
| NSB006-1922 | 7314150322152 | 1 | 507 |
| NSB006-1924 | 7314150322169 | 1 | 507 |
| NSB006-2022 | 7314150316656 | 1 | 507 |
| NSB006-2122 | 7314150322176 | 1 | 507 |
| NSB006-2123 | 7314150316663 | 1 | 507 |
| NSB006-2223 | 7314150322183 | 1 | 507 |
| NSB006-2224 | 7314150322190 | 1 | 507 |
| NSB006-2227 | 7314150322206 | 1 | 507 |
| NSB006-2326 | 7314150322213 | 1 | 507 |
| NSB006-2425 | 7314150322220 | 1 | 507 |
| NSB006-2426 | 7314150316670 | 1 | 507 |
| NSB006-2427 | 7314150322237 | 1 | 507 |
| NSB006-2430 | 7314150322244 | 1 | 507 |
| NSB006-2528 | 7314150316687 | 1 | 507 |
| NSB006-2629 | 7314150322251 | 1 | 507 |
| NSB006-2729 | 7314150316694 | 1 | 507 |
| NSB006-2730 | 7314150322336 | 1 | 507 |
| NSB006-2732 | 7314150322343 | 1 | 507 |
| NSB006-2830 | 7314150322350 | 1 | 507 |
| NSB006-3031 | 7314150322367 | 1 | 507 |
| NSB006-3032 | 7314150316700 | 1 | 507 |
| NSB006-3034 | 7314150322374 | 1 | 507 |
| NSB006-3036 | 7314150322381 | 1 | 507 |
| NSB006-3234 | 7314150322398 | 1 | 507 |
| NSB006-3235 | 7314150322404 | 1 | 507 |
| NSB006-3236 | 7314150322411 | 1 | 507 |



|               |               |   |     |
|---------------|---------------|---|-----|
| NSB006-3335   | 7314150322428 | 1 | 507 |
| NSB006-3436   | 7314150322435 | 1 | 507 |
| NSB006-3536   | 7314150322442 | 1 | 507 |
| NSB006-3638   | 7314150322459 | 1 | 507 |
| NSB006-3641   | 7314150322466 | 1 | 507 |
| NSB006-3642   | 7314150322473 | 1 | 507 |
| NSB006-4146   | 7314150322480 | 1 | 507 |
| NSB006-4650   | 7314150322497 | 1 | 507 |
| NSB006-5052   | 7314150322503 | 1 | 507 |
| NSB006-5055   | 7314150322510 | 1 | 507 |
| NSB006-5060   | 7314150322527 | 1 | 507 |
| NSB006-5062   | 7314150322534 | 1 | 507 |
| NSB006-5560   | 7314150322558 | 1 | 507 |
| NSB006-6065   | 7314150322565 | 1 | 507 |
| NSB006-6570   | 7314150322572 | 1 | 507 |
| NSB010-0607   | 7314150322589 | 1 | 508 |
| NSB010-0709   | 7314150322596 | 1 | 508 |
| NSB010-0809   | 7314150322602 | 1 | 508 |
| NSB010-0911   | 7314150322619 | 1 | 508 |
| NSB010-1011   | 7314150322626 | 1 | 508 |
| NSB010-1012   | 7314150322633 | 1 | 508 |
| NSB010-1214   | 7314150322640 | 1 | 508 |
| NSB010-1315   | 7314150322657 | 1 | 508 |
| NSB010-1417   | 7314150322664 | 1 | 508 |
| NSB010-1618   | 7314150322671 | 1 | 508 |
| NSB010-1719   | 7314150322688 | 1 | 508 |
| NSB010-1722   | 7314150322695 | 1 | 508 |
| NSB010-1819   | 7314150322718 | 1 | 508 |
| NSB010-1921   | 7314150322725 | 1 | 508 |
| NSB010-1922   | 7314150322732 | 1 | 508 |
| NSB010-2022   | 7314150322749 | 1 | 508 |
| NSB010-2123   | 7314150322756 | 1 | 508 |
| NSB010-2224   | 7314150322763 | 1 | 508 |
| NSB010-2427   | 7314150322770 | 1 | 508 |
| NSB010-2528   | 7314150322787 | 1 | 508 |
| NSB010-2628   | 7314150322794 | 1 | 508 |
| NSB010-2730   | 7314150322800 | 1 | 508 |
| NSB010-2732   | 7314150322817 | 1 | 508 |
| NSB010-3032   | 7314150322824 | 1 | 508 |
| NSB010-3036   | 7314150322831 | 1 | 508 |
| NSB010-3236   | 7314150322848 | 1 | 508 |
| NSB010-3641   | 7314150322855 | 1 | 508 |
| NSB010-4146   | 7314150322862 | 1 | 508 |
| NSB010-4650   | 7314150322879 | 1 | 508 |
| NSB011-0607   | 7314150317400 | 1 | 508 |
| NSB011-0809   | 7314150317417 | 1 | 508 |
| NSB011-1011   | 7314150317424 | 1 | 508 |
| NSB011-1213   | 7314150317431 | 1 | 508 |
| NSB011-1415   | 7314150317448 | 1 | 508 |
| NSB011-1617   | 7314150317455 | 1 | 508 |
| NSB011-1819   | 7314150317462 | 1 | 508 |
| NSB011-2022   | 7314150317479 | 1 | 508 |
| NSB011-2123   | 7314150317486 | 1 | 508 |
| NSB011-2426   | 7314150317493 | 1 | 508 |
| NSB011-2528   | 7314150317509 | 1 | 508 |
| NSB011-2729   | 7314150317516 | 1 | 508 |
| NSB011-3032   | 7314150317523 | 1 | 508 |
| NSB041-12-50  | 7314150502660 | 1 | 524 |
| NSB041-16-100 | 7314150502684 | 1 | 524 |
| NSB041-16-200 | 7314150502318 | 1 | 524 |
| NSB041-16-260 | 7314150502707 | 1 | 524 |
| NSB041-24-670 | 7314150502721 | 1 | 524 |
| NSB041-32-900 | 7314150502745 | 1 | 524 |
| NSB041-8-25   | 7314150502769 | 1 | 524 |
| NSB100-100    | 7314150323302 | 1 | 509 |
| NSB100-105    | 7314150323319 | 1 | 509 |
| NSB100-110    | 7314150323326 | 1 | 509 |
| NSB100-115    | 7314150323333 | 1 | 509 |
| NSB100-120    | 7314150323340 | 1 | 509 |
| NSB100-17     | 7314150322886 | 1 | 509 |
| NSB100-19     | 7314150322893 | 1 | 509 |
| NSB100-22     | 7314150322909 | 1 | 509 |
| NSB100-24     | 7314150322916 | 1 | 509 |
| NSB100-25     | 7314150322923 | 1 | 509 |
| NSB100-27     | 7314150322930 | 1 | 509 |
| NSB100-28     | 7314150322947 | 1 | 509 |
| NSB100-29     | 7314150322954 | 1 | 509 |
| NSB100-30     | 7314150322961 | 1 | 509 |
| NSB100-32     | 7314150322978 | 1 | 509 |
| NSB100-33     | 7314150322985 | 1 | 509 |
| NSB100-34     | 7314150322992 | 1 | 509 |
| NSB100-35     | 7314150323005 | 1 | 509 |
| NSB100-36     | 7314150323012 | 1 | 509 |
| NSB100-37     | 7314150323029 | 1 | 509 |
| NSB100-38     | 7314150323036 | 1 | 509 |
| NSB100-41     | 7314150323043 | 1 | 509 |
| NSB100-42     | 7314150323050 | 1 | 509 |
| NSB100-45     | 7314150323067 | 1 | 509 |
| NSB100-46     | 7314150323074 | 1 | 509 |
| NSB100-47     | 7314150323081 | 1 | 509 |
| NSB100-50     | 7314150323098 | 1 | 509 |
| NSB100-52     | 7314150323104 | 1 | 509 |
| NSB100-54     | 7314150323111 | 1 | 509 |
| NSB100-55     | 7314150323128 | 1 | 509 |
| NSB100-56     | 7314150323135 | 1 | 509 |
| NSB100-58     | 7314150323142 | 1 | 509 |



|            |               |   |     |
|------------|---------------|---|-----|
| NSB100-60  | 7314150323159 | 1 | 509 |
| NSB100-63  | 7314150323166 | 1 | 509 |
| NSB100-65  | 7314150323173 | 1 | 509 |
| NSB100-67  | 7314150323180 | 1 | 509 |
| NSB100-70  | 7314150323197 | 1 | 509 |
| NSB100-71  | 7314150323203 | 1 | 509 |
| NSB100-75  | 7314150323210 | 1 | 509 |
| NSB100-77  | 7314150323227 | 1 | 509 |
| NSB100-80  | 7314150323234 | 1 | 509 |
| NSB100-82  | 7314150323241 | 1 | 509 |
| NSB100-85  | 7314150323258 | 1 | 509 |
| NSB100-88  | 7314150323265 | 1 | 509 |
| NSB100-90  | 7314150323272 | 1 | 509 |
| NSB100-94  | 7314150323289 | 1 | 509 |
| NSB100-95  | 7314150323296 | 1 | 509 |
| NSB104-100 | 7314150316885 | 1 | 510 |
| NSB104-105 | 7314150316892 | 1 | 510 |
| NSB104-110 | 7314150316908 | 1 | 510 |
| NSB104-115 | 7314150323937 | 1 | 510 |
| NSB104-120 | 7314150316915 | 1 | 510 |
| NSB104-17  | 7314150323357 | 1 | 510 |
| NSB104-19  | 7314150323364 | 1 | 510 |
| NSB104-20  | 7314150323371 | 1 | 510 |
| NSB104-22  | 7314150323388 | 1 | 510 |
| NSB104-24  | 7314150316717 | 1 | 510 |
| NSB104-25  | 7314150323395 | 1 | 510 |
| NSB104-26  | 7314150323401 | 1 | 510 |
| NSB104-27  | 7314150316724 | 1 | 510 |
| NSB104-28  | 7314150323418 | 1 | 510 |
| NSB104-29  | 7314150323425 | 1 | 510 |
| NSB104-30  | 7314150316731 | 1 | 510 |
| NSB104-31  | 7314150323432 | 1 | 510 |
| NSB104-32  | 7314150316748 | 1 | 510 |
| NSB104-33  | 7314150323449 | 1 | 510 |
| NSB104-34  | 7314150323456 | 1 | 510 |
| NSB104-35  | 7314150323463 | 1 | 510 |
| NSB104-36  | 7314150316755 | 1 | 510 |
| NSB104-37  | 7314150323470 | 1 | 510 |
| NSB104-38  | 7314150323487 | 1 | 510 |
| NSB104-39  | 7314150323494 | 1 | 510 |
| NSB104-40  | 7314150323500 | 1 | 510 |
| NSB104-41  | 7314150316762 | 1 | 510 |
| NSB104-42  | 7314150323517 | 1 | 510 |
| NSB104-43  | 7314150323524 | 1 | 510 |
| NSB104-44  | 7314150323531 | 1 | 510 |
| NSB104-45  | 7314150323548 | 1 | 510 |
| NSB104-46  | 7314150316779 | 1 | 510 |
| NSB104-47  | 7314150323555 | 1 | 510 |
| NSB104-48  | 7314150323562 | 1 | 510 |
| NSB104-49  | 7314150323579 | 1 | 510 |
| NSB104-50  | 7314150316786 | 1 | 510 |
| NSB104-51  | 7314150323586 | 1 | 510 |
| NSB104-52  | 7314150323593 | 1 | 510 |
| NSB104-53  | 7314150323609 | 1 | 510 |
| NSB104-54  | 7314150323616 | 1 | 510 |
| NSB104-55  | 7314150316793 | 1 | 510 |
| NSB104-56  | 7314150323623 | 1 | 510 |
| NSB104-57  | 7314150323630 | 1 | 510 |
| NSB104-58  | 7314150323647 | 1 | 510 |
| NSB104-59  | 7314150323654 | 1 | 510 |
| NSB104-60  | 7314150316809 | 1 | 510 |
| NSB104-61  | 7314150323661 | 1 | 510 |
| NSB104-62  | 7314150323678 | 1 | 510 |
| NSB104-63  | 7314150323685 | 1 | 510 |
| NSB104-64  | 7314150323692 | 1 | 510 |
| NSB104-65  | 7314150316816 | 1 | 510 |
| NSB104-66  | 7314150323708 | 1 | 510 |
| NSB104-67  | 7314150323715 | 1 | 510 |
| NSB104-68  | 7314150323722 | 1 | 510 |
| NSB104-69  | 7314150323739 | 1 | 510 |
| NSB104-70  | 7314150316823 | 1 | 510 |
| NSB104-71  | 7314150323746 | 1 | 510 |
| NSB104-72  | 7314150323753 | 1 | 510 |
| NSB104-73  | 7314150323760 | 1 | 510 |
| NSB104-74  | 7314150323777 | 1 | 510 |
| NSB104-75  | 7314150316830 | 1 | 510 |
| NSB104-76  | 7314150323784 | 1 | 510 |
| NSB104-77  | 7314150323791 | 1 | 510 |
| NSB104-78  | 7314150323807 | 1 | 510 |
| NSB104-79  | 7314150323814 | 1 | 510 |
| NSB104-80  | 7314150316847 | 1 | 510 |
| NSB104-81  | 7314150323821 | 1 | 510 |
| NSB104-82  | 7314150323838 | 1 | 510 |
| NSB104-83  | 7314150323845 | 1 | 510 |
| NSB104-84  | 7314150323852 | 1 | 510 |
| NSB104-85  | 7314150316854 | 1 | 510 |
| NSB104-86  | 7314150323869 | 1 | 510 |
| NSB104-87  | 7314150323876 | 1 | 510 |
| NSB104-88  | 7314150323883 | 1 | 510 |
| NSB104-89  | 7314150323890 | 1 | 510 |
| NSB104-90  | 7314150316861 | 1 | 510 |
| NSB104-92  | 7314150323906 | 1 | 510 |
| NSB104-94  | 7314150323913 | 1 | 510 |
| NSB104-95  | 7314150316878 | 1 | 510 |
| NSB104-98  | 7314150323920 | 1 | 510 |
| NSB106-100 | 7314150324361 | 1 | 511 |







|             |               |   |     |
|-------------|---------------|---|-----|
| NSB106-104  | 7314150324378 | 1 | 511 |
| NSB106-108  | 7314150324385 | 1 | 511 |
| NSB106-112  | 7314150324392 | 1 | 511 |
| NSB106-114  | 7314150324408 | 1 | 511 |
| NSB106-116  | 7314150324415 | 1 | 511 |
| NSB106-120  | 7314150324422 | 1 | 511 |
| NSB106-124  | 7314150324439 | 1 | 511 |
| NSB106-126  | 7314150324446 | 1 | 511 |
| NSB106-128  | 7314150324453 | 1 | 511 |
| NSB106-132  | 7314150324460 | 1 | 511 |
| NSB106-136  | 7314150324477 | 1 | 511 |
| NSB106-138  | 7314150324484 | 1 | 511 |
| NSB106-144  | 7314150324491 | 1 | 511 |
| NSB106-146  | 7314150324507 | 1 | 511 |
| NSB106-150  | 7314150324514 | 1 | 511 |
| NSB106-156  | 7314150324521 | 1 | 511 |
| NSB106-158  | 7314150324538 | 1 | 511 |
| NSB106-20   | 7314150323944 | 1 | 510 |
| NSB106-22   | 7314150323951 | 1 | 510 |
| NSB106-24   | 7314150323968 | 1 | 510 |
| NSB106-25   | 7314150323975 | 1 | 510 |
| NSB106-26   | 7314150323982 | 1 | 510 |
| NSB106-28   | 7314150323999 | 1 | 510 |
| NSB106-30   | 7314150324002 | 1 | 510 |
| NSB106-32   | 7314150324019 | 1 | 510 |
| NSB106-34   | 7314150324026 | 1 | 510 |
| NSB106-36   | 7314150324033 | 1 | 510 |
| NSB106-38   | 7314150324040 | 1 | 510 |
| NSB106-40   | 7314150324057 | 1 | 510 |
| NSB106-42   | 7314150324064 | 1 | 510 |
| NSB106-44   | 7314150324071 | 1 | 510 |
| NSB106-45   | 7314150324088 | 1 | 510 |
| NSB106-46   | 7314150324095 | 1 | 510 |
| NSB106-48   | 7314150324101 | 1 | 510 |
| NSB106-50   | 7314150324118 | 1 | 510 |
| NSB106-52   | 7314150324125 | 1 | 510 |
| NSB106-54   | 7314150324132 | 1 | 510 |
| NSB106-56   | 7314150324149 | 1 | 510 |
| NSB106-58   | 7314150324156 | 1 | 510 |
| NSB106-60   | 7314150324163 | 1 | 510 |
| NSB106-62   | 7314150324170 | 1 | 511 |
| NSB106-64   | 7314150324187 | 1 | 511 |
| NSB106-66   | 7314150324194 | 1 | 511 |
| NSB106-68   | 7314150324200 | 1 | 511 |
| NSB106-70   | 7314150324217 | 1 | 511 |
| NSB106-71   | 7314150324224 | 1 | 511 |
| NSB106-72   | 7314150324231 | 1 | 511 |
| NSB106-74   | 7314150324248 | 1 | 511 |
| NSB106-76   | 7314150324255 | 1 | 511 |
| NSB106-78   | 7314150324262 | 1 | 511 |
| NSB106-80   | 7314150324279 | 1 | 511 |
| NSB106-82   | 7314150324286 | 1 | 511 |
| NSB106-84   | 7314150324293 | 1 | 511 |
| NSB106-88   | 7314150324309 | 1 | 511 |
| NSB106-90   | 7314150324316 | 1 | 511 |
| NSB106-92   | 7314150324323 | 1 | 511 |
| NSB106-94   | 7314150324330 | 1 | 511 |
| NSB106-96   | 7314150324347 | 1 | 511 |
| NSB106-98   | 7314150324354 | 1 | 511 |
| NSB200-1200 | 7314150324613 | 1 | 511 |
| NSB200-200  | 7314150324545 | 1 | 511 |
| NSB200-250  | 7314150324552 | 1 | 511 |
| NSB200-300  | 7314150324569 | 1 | 511 |
| NSB200-350  | 7314150324576 | 1 | 511 |
| NSB200-450  | 7314150324583 | 1 | 511 |
| NSB200-600  | 7314150324590 | 1 | 511 |
| NSB200-900  | 7314150324606 | 1 | 511 |
| NSB202-350  | 7314150324620 | 1 | 511 |
| NSB203-200  | 7314150359561 | 1 | 511 |
| NSB203-215  | 7314150359578 | 1 | 511 |
| NSB203-290  | 7314150359585 | 1 | 511 |
| NSB203-400  | 7314150359592 | 1 | 511 |
| NSB203-490  | 7314150359608 | 1 | 511 |
| NSB203-800  | 7314150359615 | 1 | 511 |
| NSB204-30   | 7314150324637 | 1 | 512 |
| NSB204-32   | 7314150324644 | 1 | 512 |
| NSB204-35   | 7314150324651 | 1 | 512 |
| NSB204-40   | 7314150324668 | 1 | 512 |
| NSB204-45   | 7314150324675 | 1 | 512 |
| NSB204-48   | 7314150324682 | 1 | 512 |
| NSB204-50   | 7314150324699 | 1 | 512 |
| NSB204-55   | 7314150324705 | 1 | 512 |
| NSB204-60   | 7314150324712 | 1 | 512 |
| NSB204-65   | 7314150324729 | 1 | 512 |
| NSB204-70   | 7314150324736 | 1 | 512 |
| NSB204-75   | 7314150324743 | 1 | 512 |
| NSB204-80   | 7314150324750 | 1 | 512 |
| NSB204-85   | 7314150324767 | 1 | 512 |
| NSB204-90   | 7314150324774 | 1 | 512 |
| NSB220-06   | 7314150354023 | 1 | 512 |
| NSB220-07   | 7314150354030 | 1 | 512 |
| NSB220-08   | 7314150354047 | 1 | 512 |
| NSB220-09   | 7314150354054 | 1 | 512 |
| NSB220-10   | 7314150354061 | 1 | 512 |
| NSB220-11   | 7314150354078 | 1 | 512 |
| NSB220-12   | 7314150354085 | 1 | 512 |



|                |               |   |     |
|----------------|---------------|---|-----|
| NSB220-13      | 7314150354092 | 1 | 512 |
| NSB220-14      | 7314150354108 | 1 | 512 |
| NSB220-15      | 7314150354115 | 1 | 512 |
| NSB220-16      | 7314150354122 | 1 | 512 |
| NSB220-17      | 7314150354139 | 1 | 512 |
| NSB220-18      | 7314150354146 | 1 | 512 |
| NSB220-19      | 7314150354153 | 1 | 512 |
| NSB220-20      | 7314150354160 | 1 | 512 |
| NSB220-21      | 7314150354177 | 1 | 512 |
| NSB220-22      | 7314150354184 | 1 | 512 |
| NSB220-23      | 7314150354191 | 1 | 512 |
| NSB220-24      | 7314150354207 | 1 | 512 |
| NSB220-25      | 7314150354214 | 1 | 512 |
| NSB220-26      | 7314150354221 | 1 | 512 |
| NSB220-27      | 7314150354238 | 1 | 512 |
| NSB220-28      | 7314150354245 | 1 | 512 |
| NSB220-29      | 7314150354252 | 1 | 512 |
| NSB220-30      | 7314150354269 | 1 | 512 |
| NSB220-32      | 7314150354276 | 1 | 512 |
| NSB224-17      | 7314150355723 | 1 | 512 |
| NSB224-18      | 7314150355730 | 1 | 512 |
| NSB224-19      | 7314150355747 | 1 | 512 |
| NSB224-21      | 7314150355754 | 1 | 512 |
| NSB224-22      | 7314150355761 | 1 | 512 |
| NSB224-23      | 7314150355778 | 1 | 512 |
| NSB224-24      | 7314150355785 | 1 | 512 |
| NSB224-26      | 7314150355792 | 1 | 512 |
| NSB224-27      | 7314150355808 | 1 | 512 |
| NSB224-28      | 7314150355815 | 1 | 512 |
| NSB224-29      | 7314150355822 | 1 | 512 |
| NSB224-30      | 7314150355839 | 1 | 512 |
| NSB224-32      | 7314150355846 | 1 | 512 |
| NSB224-34      | 7314150355853 | 1 | 512 |
| NSB224-36      | 7314150355860 | 1 | 512 |
| NSB224-38      | 7314150355877 | 1 | 512 |
| NSB224-41      | 7314150355884 | 1 | 512 |
| NSB224-46      | 7314150355891 | 1 | 513 |
| NSB224-50      | 7314150355907 | 1 | 513 |
| NSB228-22      | 7314150356126 | 1 | 513 |
| NSB228-24      | 7314150356133 | 1 | 513 |
| NSB228-26      | 7314150356140 | 1 | 513 |
| NSB228-27      | 7314150356157 | 1 | 513 |
| NSB228-28      | 7314150356164 | 1 | 513 |
| NSB228-29      | 7314150356171 | 1 | 513 |
| NSB228-30      | 7314150356188 | 1 | 513 |
| NSB228-31      | 7314150356195 | 1 | 513 |
| NSB228-32      | 7314150356201 | 1 | 513 |
| NSB228-34      | 7314150356218 | 1 | 513 |
| NSB228-36      | 7314150356225 | 1 | 513 |
| NSB228-38      | 7314150356232 | 1 | 513 |
| NSB228-41      | 7314150356249 | 1 | 513 |
| NSB228-46      | 7314150356256 | 1 | 513 |
| NSB228-50      | 7314150356263 | 1 | 513 |
| NSB228-55      | 7314150356270 | 1 | 513 |
| NSB228-60      | 7314150356287 | 1 | 513 |
| NSB228-65      | 7314150356294 | 1 | 513 |
| NSB228-70      | 7314150356300 | 1 | 513 |
| NSB228-75      | 7314150356317 | 1 | 513 |
| NSB228-80      | 7314150356324 | 1 | 513 |
| NSB232-16-24   | 7314150356379 | 1 | 513 |
| NSB232-24-16   | 7314150356393 | 1 | 513 |
| NSB232-24-32   | 7314150356386 | 1 | 513 |
| NSB232-32-24   | 7314150356409 | 1 | 513 |
| NSB234-16-100  | 7314150356461 | 1 | 513 |
| NSB234-16-200  | 7314150356478 | 1 | 513 |
| NSB234-16-250  | 7314150356485 | 1 | 513 |
| NSB234-24-200  | 7314150356492 | 1 | 513 |
| NSB234-32-250  | 7314150356508 | 1 | 513 |
| NSB236-16      | 7314150356553 | 1 | 514 |
| NSB236-24      | 7314150356546 | 1 | 514 |
| NSB236-32      | 7314150356560 | 1 | 514 |
| NSB238-16-250  | 7314150356621 | 1 | 514 |
| NSB238-24-250  | 7314150356614 | 1 | 514 |
| NSB238-32-300  | 7314150356607 | 1 | 514 |
| NSB240-16-230  | 7314150356744 | 1 | 514 |
| NSB242-16      | 7314150356669 | 1 | 514 |
| NSB242-24      | 7314150356676 | 1 | 514 |
| NSB242-32      | 7314150356683 | 1 | 514 |
| NSB243-16-400  | 7314150356706 | 1 | 514 |
| NSB247-26      | 7314150356768 | 1 | 515 |
| NSB248-16-52   | 7314150356720 | 1 | 515 |
| NSB300-10-200  | 7314150317646 | 1 | 515 |
| NSB300-10-300  | 7314150295845 | 1 | 515 |
| NSB300-11-250  | 7314150317653 | 1 | 515 |
| NSB300-11-300  | 7314150317660 | 1 | 515 |
| NSB300-11-350  | 7314150295852 | 1 | 515 |
| NSB300-12-400  | 7314150295869 | 1 | 515 |
| NSB300-13-450  | 7314150295876 | 1 | 515 |
| NSB300-3-50    | 7314150317530 | 1 | 515 |
| NSB300-3-75    | 7314150317547 | 1 | 515 |
| NSB300-4-75    | 7314150317554 | 1 | 515 |
| NSB300-4.5-100 | 7314150295838 | 1 | 515 |
| NSB300-4.5-50  | 7314150317561 | 1 | 515 |
| NSB300-5-100   | 7314150317585 | 1 | 515 |
| NSB300-5-75    | 7314150317578 | 1 | 515 |
| NSB300-6-100   | 7314150285327 | 1 | 515 |



|                 |               |   |     |
|-----------------|---------------|---|-----|
| NSB300-6-125    | 7314150317592 | 1 | 515 |
| NSB300-6-150    | 7314150317608 | 1 | 515 |
| NSB300-7-150    | 7314150317615 | 1 | 515 |
| NSB300-8-150    | 7314150285334 | 1 | 515 |
| NSB300-8-200    | 7314150317622 | 1 | 515 |
| NSB300-9-250    | 7314150317639 | 1 | 515 |
| NSB301-10-200   | 7314150317974 | 1 | 516 |
| NSB301-10-300   | 7314150317981 | 1 | 516 |
| NSB301-3-50     | 7314150317905 | 1 | 516 |
| NSB301-4-100    | 7314150317912 | 1 | 516 |
| NSB301-4-150    | 7314150317929 | 1 | 516 |
| NSB301-5-100    | 7314150317936 | 1 | 516 |
| NSB301-5-200    | 7314150317943 | 1 | 516 |
| NSB301-6-100    | 7314150317950 | 1 | 516 |
| NSB301-8-150    | 7314150317967 | 1 | 516 |
| NSB302-0-50     | 7314150295883 | 1 | 516 |
| NSB302-1-100    | 7314150285341 | 1 | 516 |
| NSB302-2-125    | 7314150285358 | 1 | 516 |
| NSB302-3-150    | 7314150295890 | 1 | 516 |
| NSB302-4-300    | 7314150295906 | 1 | 516 |
| NSB304-0-50     | 7314150295913 | 1 | 516 |
| NSB304-1-100    | 7314150295920 | 1 | 516 |
| NSB304-2-125    | 7314150295937 | 1 | 516 |
| NSB304-3-150    | 7314150295944 | 1 | 516 |
| NSB304-4-300    | 7314150295951 | 1 | 516 |
| NSB320-10       | 7314150318070 | 1 | 516 |
| NSB320-2        | 7314150317998 | 1 | 516 |
| NSB320-3        | 7314150318001 | 1 | 516 |
| NSB320-4        | 7314150318018 | 1 | 516 |
| NSB320-5        | 7314150318025 | 1 | 516 |
| NSB320-6        | 7314150318032 | 1 | 516 |
| NSB320-7        | 7314150318049 | 1 | 516 |
| NSB320-8        | 7314150318056 | 1 | 516 |
| NSB320-9        | 7314150318063 | 1 | 516 |
| NSB400-160      | 7314150295968 | 1 | 516 |
| NSB400-180      | 7314150285365 | 1 | 516 |
| NSB400-200      | 7314150295975 | 1 | 516 |
| NSB402-160      | 7314150295982 | 1 | 517 |
| NSB402-200      | 7314150285372 | 1 | 517 |
| NSB403-160      | 7314150318179 | 1 | 517 |
| NSB403-180      | 7314150318186 | 1 | 517 |
| NSB404-160      | 7314150318223 | 1 | 517 |
| NSB405-160      | 7314150318230 | 1 | 517 |
| NSB406-160      | 7314150295999 | 1 | 517 |
| NSB406-180      | 7314150318254 | 1 | 517 |
| NSB406-200      | 7314150296002 | 1 | 517 |
| NSB407-160      | 7314150318285 | 1 | 518 |
| NSB408-250      | 7314150285389 | 1 | 518 |
| NSB408-300      | 7314150318308 | 1 | 518 |
| NSB411-200      | 7314150318315 | 1 | 518 |
| NSB412-200      | 7314150318346 | 1 | 518 |
| NSB413-180      | 7314150318353 | 1 | 518 |
| NSB413-200      | 7314150318360 | 1 | 518 |
| NSB500-1000-FB  | 7314150324828 | 1 | 519 |
| NSB500-1500-FB  | 7314150324835 | 1 | 519 |
| NSB500-2000     | 7314150324781 | 1 | 518 |
| NSB500-2000-FB  | 7314150324842 | 1 | 519 |
| NSB500-2500     | 7314150324798 | 1 | 518 |
| NSB500-2500-FB  | 7314150324859 | 1 | 519 |
| NSB500-3000     | 7314150324804 | 1 | 518 |
| NSB500-3000-FB  | 7314150324866 | 1 | 519 |
| NSB500-3500-FB  | 7314150324873 | 1 | 519 |
| NSB500-4000     | 7314150324811 | 1 | 518 |
| NSB502-1000-FB  | 7314150316922 | 1 | 519 |
| NSB502-10000-FB | 7314150316991 | 1 | 519 |
| NSB502-12000-FB | 7314150318414 | 1 | 519 |
| NSB502-1500-FB  | 7314150318421 | 1 | 519 |
| NSB502-2000-FB  | 7314150316939 | 1 | 519 |
| NSB502-2500-FB  | 7314150316946 | 1 | 519 |
| NSB502-3000-FB  | 7314150316953 | 1 | 519 |
| NSB502-450-FB   | 7314150324880 | 1 | 519 |
| NSB502-4500-FB  | 7314150316960 | 1 | 519 |
| NSB502-5000-FB  | 7314150316977 | 1 | 519 |
| NSB502-6800-FB  | 7314150318452 | 1 | 519 |
| NSB502-8000-FB  | 7314150316984 | 1 | 519 |
| NSB504-100-FB   | 7314150317004 | 1 | 519 |
| NSB504-1000-FB  | 7314150317059 | 1 | 519 |
| NSB504-1500-FB  | 7314150317066 | 1 | 519 |
| NSB504-200-FB   | 7314150317011 | 1 | 519 |
| NSB504-2000-FB  | 7314150317073 | 1 | 519 |
| NSB504-300-FB   | 7314150317028 | 1 | 519 |
| NSB504-500-FB   | 7314150317035 | 1 | 519 |
| NSB504-800-FB   | 7314150317042 | 1 | 519 |
| NSB506-300      | 7314150324897 | 1 | 519 |
| NSB506-300-FB   | 7314150318490 | 1 | 520 |
| NSB506-450      | 7314150324903 | 1 | 519 |
| NSB506-450-FB   | 7314150318483 | 1 | 520 |
| NSB506-700      | 7314150324910 | 1 | 519 |
| NSB506-700-FB   | 7314150317080 | 1 | 520 |
| NSB506-900      | 7314150324927 | 1 | 519 |
| NSB506-900-FB   | 7314150317097 | 1 | 520 |
| NSB508-500-FB   | 7314150318513 | 1 | 520 |
| NSB508-700-FB   | 7314150318520 | 1 | 520 |
| NSB512-200-FB   | 7314150318643 | 1 | 520 |
| NSB512-400-FB   | 7314150318636 | 1 | 520 |
| NSB512-600-FB   | 7314150318629 | 1 | 520 |



|                |               |    |     |
|----------------|---------------|----|-----|
| NSB512-900-FB  | 7314150318605 | 1  | 520 |
| NSB600-100-50  | 7314150317110 | 1  | 520 |
| NSB600-135-50  | 7314150317127 | 1  | 520 |
| NSB600-150-25  | 7314150317134 | 1  | 520 |
| NSB600-150-30  | 7314150317141 | 1  | 520 |
| NSB600-150-40  | 7314150317158 | 1  | 520 |
| NSB600-150-50  | 7314150317165 | 1  | 520 |
| NSB600-180-13  | 7314150317172 | 1  | 520 |
| NSB600-180-32  | 7314150317189 | 1  | 520 |
| NSB600-180-50  | 7314150317196 | 1  | 520 |
| NSB600-200-20  | 7314150317202 | 1  | 520 |
| NSB600-200-30  | 7314150317219 | 1  | 520 |
| NSB600-200-40  | 7314150317226 | 1  | 520 |
| NSB600-200-50  | 7314150317233 | 1  | 520 |
| NSB600-230-40  | 7314150317240 | 1  | 520 |
| NSB600-250-40  | 7314150317257 | 1  | 520 |
| NSB600-300-50  | 7314150317264 | 1  | 520 |
| NSB600-80-13   | 7314150317103 | 1  | 520 |
| NSB602-460     | 7314150324934 | 1  | 521 |
| NSB602-600     | 7314150324941 | 1  | 521 |
| NSB602-760     | 7314150324958 | 1  | 521 |
| NSB602-900     | 7314150324965 | 1  | 521 |
| NSB604-150     | 7314150324972 | 1  | 521 |
| NSB604-200     | 7314150324989 | 1  | 521 |
| NSB604-300     | 7314150324996 | 1  | 521 |
| NSB606-150     | 7314150325009 | 1  | 521 |
| NSB606-200     | 7314150325016 | 1  | 521 |
| NSB606-250     | 7314150325023 | 1  | 521 |
| NSB606-300     | 7314150325030 | 1  | 521 |
| NSB606-400     | 7314150325047 | 1  | 521 |
| NSB608-100     | 7314150325054 | 1  | 521 |
| NSB700-300     | 7314150296255 | 1  | 522 |
| NSB702-200     | 7314150296262 | 1  | 522 |
| NSB704-225     | 7314150296279 | 1  | 522 |
| NSB706-50      | 7314150296286 | 1  | 522 |
| NSB706-80      | 7314150296293 | 1  | 522 |
| NSB708-360     | 7314150296309 | 1  | 522 |
| NSB710-450     | 7314150296316 | 1  | 523 |
| NSB800-1100    | 7314150325061 | 1  | 523 |
| NSB800-1700    | 7314150325078 | 1  | 523 |
| NSB800-2000    | 7314150325085 | 1  | 523 |
| NSB802-290     | 7314150325092 | 1  | 523 |
| NSB810-100     | 7314150318650 | 1  | 523 |
| NSB810-150     | 7314150318667 | 1  | 523 |
| NSB810-200     | 7314150318674 | 1  | 523 |
| NSB810-350     | 7314150318681 | 1  | 523 |
| P-HB           | 7314150125272 | 25 | 542 |
| P-MEC          | 7314150374342 | 24 | 543 |
| P-MEC-LEAD     | 7314150374359 | 12 | 543 |
| P1-20          | 7311518044572 | 5  | 621 |
| P1-23          | 7311518332501 | 5  | 621 |
| P108-20-F      | 7311518275518 | 2  | 621 |
| P108-23-F      | 7311518275525 | 2  | 621 |
| P11            | 7311518009076 | 6  | 632 |
| P110-20-F      | 7311518275532 | 2  | 621 |
| P110-23-F      | 7311518275549 | 2  | 621 |
| P114-SL-40     | 7311518301149 | 2  | 624 |
| P114-SL-50     | 7311518301156 | 2  | 624 |
| P114-SL-60     | 7311518301163 | 2  | 624 |
| P116-SL-40     | 7311518301101 | 2  | 625 |
| P116-SL-50     | 7311518301118 | 2  | 625 |
| P116-SL-60     | 7311518301125 | 2  | 625 |
| P116-SL-70     | 7311518301132 | 2  | 625 |
| P121-18-F      | 7311518275662 | 6  | 622 |
| P121-20-F      | 7311518275631 | 6  | 622 |
| P121-23-F      | 7311518275648 | 6  | 622 |
| P123-19-BULK30 | 7311518218218 | 30 | 624 |
| P126-19-F      | 7311518275297 | 6  | 624 |
| P126-22-F      | 7311518275303 | 6  | 622 |
| P127-19-BULK30 | 7311518199333 | 30 | 624 |
| P128-19        | 7311518160814 | 6  | 624 |
| P128-19-BULK30 | 7311518172329 | 30 | 624 |
| P129-19-BULK30 | 7311518172336 | 30 | 624 |
| P130-F         | 7311518333980 | 6  | 625 |
| P138-22-BULK6  | 7311518328696 | 6  | 622 |
| P138-22-F      | 7311518301279 | 6  | 622 |
| P140-F         | 7311518275372 | 6  | 625 |
| P16-40         | 7311518013479 | 2  | 624 |
| P16-40W        | 7311518043049 | 2  | 624 |
| P16-50-F       | 7311518301286 | 2  | 624 |
| P16-60-F       | 7311518276461 | 2  | 624 |
| P160-SL-60     | 7311518301170 | 2  | 625 |
| P160-SL-75     | 7311518301187 | 1  | 625 |
| P160-SL-90     | 7311518301194 | 1  | 625 |
| P173-SL-85     | 7311518334703 | 1  | 625 |
| P19-80-F       | 7311518275365 | 1  | 625 |
| P20            | 7311518009281 | 6  | 632 |
| P241           | 7311518008956 | 5  | 617 |
| P262           | 7311518299286 | 10 | 616 |
| P263           | 7311518299262 | 10 | 616 |
| P264           | 7311518299279 | 10 | 616 |
| P266           | 7311518299293 | 10 | 617 |
| P267           | 7311518299309 | 10 | 616 |
| P268           | 7311518299316 | 10 | 616 |
| P269           | 7311518299323 | 10 | 617 |
| P270           | 7311518299330 | 10 | 617 |





|                 |               |    |     |
|-----------------|---------------|----|-----|
| P272            | 7311518299354 | 5  | 616 |
| P274            | 7311518299347 | 5  | 616 |
| P276            | 7311518299361 | 5  | 617 |
| P277            | 7311518299378 | 5  | 616 |
| P278            | 7311518299385 | 5  | 616 |
| P280-SL-60      | 7311518346508 | 2  | 625 |
| P280-SL-80      | 7311518301330 | 2  | 625 |
| P3-20-F         | 7311518275259 | 2  | 621 |
| P3-23-F         | 7311518275266 | 2  | 621 |
| P34-27A-F       | 7311518275464 | 2  | 627 |
| P34-37          | 7311518002787 | 2  | 627 |
| P5-23-F         | 7311518275280 | 2  | 621 |
| P51-F           | 7311518275426 | 2  | 630 |
| P51-SL          | 7311518301217 | 2  | 630 |
| P51H-SL         | 7311518301224 | 2  | 630 |
| P52-SL-20       | 7311518347307 | 2  | 631 |
| P54-SL-25       | 7311518301231 | 2  | 631 |
| P54H-SL-25      | 7311518301255 | 2  | 631 |
| P57-25-F        | 7311518301293 | 4  | 630 |
| P59-25-F        | 7311518275655 | 6  | 631 |
| P6160           | 7314150115075 | 10 | 647 |
| P64-20-BULK12   | 7311518288204 | 12 | 622 |
| P74             | 7311518124076 | 40 | 632 |
| P75             | 7311518124083 | 48 | 632 |
| PAGS-2.0        | 7311518327835 | 1  | 601 |
| PAGS-2.0-900FG  | 7311518292355 | 1  | 601 |
| PBB-8           | 7314150399376 | 8  | 542 |
| PBS-700         | 7314150341689 | 6  | 542 |
| PC-10-DTF       | 7311518263560 | 10 | 566 |
| PC-10-DTL       | 7311518263553 | 10 | 566 |
| PC-10-DTR       | 7311518263546 | 10 | 566 |
| PC-11-19-PS     | 7311518285548 | 4  | 565 |
| PC-11-19-PS-B   | 7311518285555 | 10 | 565 |
| PC-12-14-PS     | 7311518285562 | 4  | 565 |
| PC-12-14-PS-B   | 7311518285579 | 10 | 565 |
| PC-12-COM       | 7311518263454 | 4  | 560 |
| PC-12-TEN       | 7311518263447 | 4  | 564 |
| PC-12-VEN       | 7311518263430 | 4  | 564 |
| PC-15-GNP       | 7311518264307 | 4  | 560 |
| PC-15-TBX       | 7311518263423 | 4  | 564 |
| PC-16-DECO      | 7311518264987 | 4  | 561 |
| PC-16-FILE-U7   | 7311518263461 | 4  | 562 |
| PC-19-FILE-U7   | 7311518263478 | 4  | 562 |
| PC-19-GT7       | 7311518263362 | 4  | 562 |
| PC-19-GT9       | 7311518263379 | 4  | 564 |
| PC-20-LAM       | 7311518258290 | 4  | 563 |
| PC-20-PRC       | 7311518264291 | 4  | 564 |
| PC-22-FILE-U7   | 7311518263485 | 4  | 562 |
| PC-22-GT7       | 7311518263393 | 4  | 562 |
| PC-22-GT9       | 7311518263409 | 4  | 564 |
| PC-22-INS       | 7314150154500 | 4  | 561 |
| PC-22-PLC       | 7314150276318 | 4  | 560 |
| PC-24-FILE-U7   | 7311518263492 | 4  | 562 |
| PC-24-PLS       | 7311518263508 | 4  | 560 |
| PC-24-TIM       | 7311518263515 | 4  | 565 |
| PC-6-DRY        | 7311518282004 | 6  | 560 |
| PC-9-9/17-PS    | 7311518285586 | 4  | 565 |
| PC-9-9/17-PS-B  | 7311518285593 | 10 | 565 |
| PENCIL-200-DISP | 7314150125227 | 1  | 543 |
| PG-01-F         | 7311518329334 | 6  | 622 |
| PG-03-L         | 7311518242855 | 2  | 622 |
| PG-12-BULK15    | 7311518334628 | 15 | 622 |
| PG-12-F         | 7311518328122 | 10 | 622 |
| PG-18-45-F      | 7311518299033 | 2  | 625 |
| PG-18-60-F      | 7311518288853 | 2  | 625 |
| PG-19-F         | 7311518295936 | 2  | 625 |
| PG-56-F         | 7311518288938 | 2  | 631 |
| PG-57-F         | 7311518295943 | 2  | 631 |
| PG-72           | 7311518242534 | 4  | 634 |
| PH-6604-1P      | 7311518152819 | 15 | 35  |
| PH-6604-25      | 7311518141134 | 25 | 35  |
| PS501-1         | 7314150338283 | 1  | 654 |
| PS501-2         | 7314150112432 | 1  | 654 |
| PS501-3         | 7314150338290 | 1  | 654 |
| PS501-4         | 7314150338306 | 1  | 654 |
| PU-14           | 7314150016266 | 5  | 44  |
| PU-20           | 7314150016389 | 3  | 44  |
| PU-22           | 7314150016426 | 3  | 44  |
| PU-24           | 7314150016464 | 3  | 44  |
| PU-6            | 7314150016105 | 5  | 44  |
| PU-9            | 7314150016167 | 5  | 44  |
| PX-L2           | 7311518233853 | 2  | 620 |
| PX-L3           | 7311518233860 | 2  | 620 |
| PX-M1           | 7311518233815 | 2  | 620 |
| PX-M2           | 7311518233822 | 2  | 620 |
| PX-M2-L         | 7311518240714 | 2  | 620 |
| PX-M3           | 7311518233839 | 2  | 620 |
| PX-S1           | 7311518233785 | 2  | 620 |
| PX-S2           | 7311518233792 | 2  | 620 |
| PXR-L2          | 7311518233914 | 2  | 620 |
| PXR-M1          | 7311518233877 | 2  | 620 |
| PXR-M2          | 7311518233884 | 2  | 620 |
| PXR-M2-L        | 7311518240738 | 2  | 620 |
| PXR-M3          | 7311518233891 | 2  | 620 |
| PXR-S1          | 7311518240677 | 2  | 620 |
| PXR-S2          | 7311518240684 | 2  | 620 |



|               |               |    |     |
|---------------|---------------|----|-----|
| PXR-S2-L      | 7311518346799 | 2  | 620 |
| QC-115A       | 7314150460007 | 12 | 588 |
| QC-115A-2P    | 7314150460021 | 6  | 588 |
| QC-150A       | 7314150460045 | 6  | 588 |
| QC-150A-2P    | 7314150460069 | 6  | 588 |
| QC-300A       | 7314150401925 | 6  | 588 |
| QC-300A-2P    | 7314150460090 | 4  | 588 |
| QCB-1250      | 7314150135981 | 8  | 588 |
| QCB-150       | 7314150135912 | 6  | 588 |
| QCB-300       | 7314150135936 | 6  | 588 |
| QCB-450       | 7314150135950 | 6  | 588 |
| QCB-600       | 7314150135967 | 4  | 588 |
| QCB-900       | 7314150135974 | 4  | 588 |
| QCG-150       | 7314150135899 | 6  | 588 |
| QCG-300       | 7314150135905 | 6  | 588 |
| R1068         | 7311518044398 | 1  | 623 |
| R1069P        | 7311518219574 | 12 | 623 |
| R1071         | 7311518222918 | 14 | 624 |
| R1075-BULK50  | 7311518220495 | 50 | 624 |
| R1080P        | 7311518282479 | 1  | 623 |
| R112PG        | 7311518010058 | 1  | 622 |
| R113PG        | 7311518044374 | 30 | 623 |
| R114PG        | 7311518010065 | 1  | 622 |
| R114V         | 7311518042660 | 25 | 625 |
| R114V-BULK28  | 7311518177539 | 28 | 625 |
| R115V         | 7311518243210 | 8  | 625 |
| R115V-BULK14  | 7311518288341 | 14 | 625 |
| R116V         | 7311518010164 | 1  | 625 |
| R116V-BULK36  | 7311518159924 | 36 | 625 |
| R119V         | 7311518029487 | 1  | 625 |
| R122PG        | 7311518010072 | 30 | 622 |
| R123PG        | 7311518044381 | 30 | 623 |
| R124PG        | 7311518010089 | 30 | 622 |
| R1269P-BULK50 | 7311518240820 | 50 | 621 |
| R133PG        | 7311518328252 | 1  | 629 |
| R137E         | 7311518011574 | 30 | 628 |
| R142P         | 7311518010126 | 24 | 623 |
| R143PV        | 7311518010133 | 1  | 626 |
| R143PVCB      | 7311518255633 | 1  | 626 |
| R144PV        | 7311518291075 | 24 | 626 |
| R146VC        | 7311518046545 | 22 | 631 |
| R146VS        | 7311518046538 | 24 | 626 |
| R146VS-BULK50 | 7311518159955 | 50 | 626 |
| R147V         | 7311518044909 | 24 | 631 |
| R148V         | 7311518223922 | 1  | 623 |
| R1601         | 7311518044640 | 1  | 623 |
| R160A         | 7311518201821 | 1  | 625 |
| R160A-BULK28  | 7311518337216 | 28 | 625 |
| R166V         | 7311518328085 | 22 | 626 |
| R16V          | 7311518254513 | 1  | 625 |
| R16V-BULK14   | 7311518288334 | 14 | 625 |
| R181P         | 7311518296087 | 1  | 625 |
| R185V         | 7311518331795 | 25 | 625 |
| R201P         | 7311518219536 | 1  | 622 |
| R201P-BULK80  | 7311518225209 | 80 | 622 |
| R202P         | 7311518219550 | 1  | 623 |
| R211P         | 7311518234027 | 1  | 620 |
| R211P-BULK80  | 7311518252212 | 80 | 620 |
| R214SL        | 7311518301392 | 1  | 626 |
| R214V         | 7311518042745 | 1  | 622 |
| R214V-BULK28  | 7311518177553 | 28 | 626 |
| R215V         | 7311518243227 | 1  | 626 |
| R216SL        | 7311518301408 | 8  | 626 |
| R221P         | 7311518229412 | 1  | 622 |
| R221P-BULK50  | 7311518240653 | 50 | 622 |
| R223P         | 7311518237554 | 1  | 622 |
| R223P-BULK80  | 7311518240646 | 80 | 622 |
| R230P         | 7311518341503 | 10 | 628 |
| R239P         | 7311518219567 | 1  | 623 |
| R260A         | 7311518201814 | 16 | 626 |
| R272H         | 7311518258016 | 1  | 626 |
| R300P         | 7311518234034 | 1  | 620 |
| R303P         | 7311518234157 | 1  | 620 |
| R310-0        | 7314151829797 | 1  | 56  |
| R310-1        | 7314151829803 | 1  | 56  |
| R310-2        | 7314151829810 | 1  | 56  |
| R310-3        | 7314151829827 | 1  | 56  |
| R312V         | 7311518235420 | 1  | 626 |
| R315V         | 7311518243234 | 1  | 626 |
| R318V         | 7311518029500 | 1  | 626 |
| R328V         | 7311518296056 | 22 | 626 |
| R335V         | 7311518331801 | 12 | 626 |
| R337E         | 7311518011598 | 1  | 629 |
| R341P         | 7311518011529 | 12 | 623 |
| R372H         | 7311518235406 | 1  | 626 |
| R373A         | 7311518334710 | 25 | 625 |
| R403P         | 7311518234164 | 1  | 620 |
| R415V         | 7311518243241 | 1  | 626 |
| R4230         | 7311518341510 | 10 | 628 |
| R427AE        | 7311518176068 | 18 | 629 |
| R434P         | 7311518223885 | 1  | 623 |
| R434P-BULK50  | 7311518169916 | 50 | 623 |
| R437E         | 7311518011611 | 18 | 629 |
| R438P         | 7311518229429 | 1  | 623 |
| R438P-BULK50  | 7311518240660 | 50 | 623 |
| R440V         | 7311518254544 | 22 | 626 |



| Part Number     | Quantity | Part Number   | Quantity |
|-----------------|----------|---------------|----------|
| R444V           | 22       | 7311518243340 | 22       |
| R463P           | 1        | 7311518223908 | 1        |
| R472H           | 30       | 7311518334840 | 30       |
| R474P           | 1        | 7311518011536 | 1        |
| R478P           | 1        | 7311518275600 | 1        |
| R480P           | 1        | 7311518282486 | 1        |
| R500P           | 40       | 7311518234041 | 40       |
| R503P           | 1        | 7311518234171 | 1        |
| R515VS          | 22       | 7311518046514 | 22       |
| R516V           | 22       | 7311518200824 | 22       |
| R519V           | 1        | 7311518029517 | 1        |
| R600P           | 1        | 7311518240783 | 1        |
| R603P           | 1        | 7311518240790 | 1        |
| R615V           | 1        | 7311518010119 | 1        |
| R619V           | 1        | 7311518029494 | 1        |
| R660V           | 24       | 7311518210281 | 24       |
| R6725MK         | 1        | 7314151088354 | 1        |
| R6725ZK         | 1        | 7314151784898 | 1        |
| R680V           | 1        | 7311518042752 | 1        |
| R6810M-10       | 5        | 7314150195152 | 5        |
| R6810M-3,4      | 5        | 7314150195077 | 5        |
| R6810M-4        | 5        | 7314150195084 | 5        |
| R6810M-4,5      | 5        | 7314150195091 | 5        |
| R6810M-5        | 5        | 7314150195107 | 5        |
| R6810M-6        | 5        | 7314150195114 | 5        |
| R6810M-7        | 1        | 7314150195121 | 1        |
| R6810M-8        | 5        | 7314150195138 | 5        |
| R6810M-9        | 5        | 7314150195145 | 5        |
| R6810Z-1/4      | 1        | 7314150429448 | 1        |
| R6810Z-3/16     | 1        | 7314150429387 | 1        |
| R6810Z-3/8      | 1        | 7314150429394 | 1        |
| R6810Z-5/16     | 1        | 7314150429400 | 1        |
| R6810Z-7/32     | 1        | 7314150429417 | 1        |
| R6822Z          | 5        | 7314150429424 | 5        |
| R6950           | 1        | 7314151089658 | 1        |
| R6964A          | 1        | 7314150195176 | 1        |
| R6967           | 5        | 7314150195169 | 5        |
| R716VCB         | 40       | 7311518255497 | 40       |
| R772V           | 14       | 7311518301385 | 14       |
| R773V           | 1        | 7311518324414 | 1        |
| R775V           | 1        | 7311518331818 | 1        |
| R776V           | 1        | 7311518334734 | 1        |
| R801P           | 1        | 7311518234126 | 1        |
| R802P           | 1        | 7311518234133 | 1        |
| R803P           | 1        | 7311518234140 | 1        |
| R804P           | 1        | 7311518240806 | 1        |
| R811P           | 1        | 7311518234058 | 1        |
| R812P           | 1        | 7311518234065 | 1        |
| R813P           | 1        | 7311518234072 | 1        |
| R815P           | 1        | 7311518240752 | 1        |
| R900P           | 1        | 7311518234188 | 1        |
| R901P           | 30       | 7311518234195 | 30       |
| R902P           | 24       | 7311518234201 | 24       |
| R903P           | 1        | 7311518234218 | 1        |
| R904P           | 1        | 7311518234225 | 1        |
| R905P           | 1        | 7311518234232 | 1        |
| R905P-BULK50    | 50       | 7311518252250 | 50       |
| R906P           | 1        | 7311518234249 | 1        |
| R906P-BULK50    | 50       | 7311518252267 | 50       |
| R907P           | 1        | 7311518234256 | 1        |
| RAIL-10         | 10       | 7314150511075 | 10       |
| RAIL-340        | 3        | 7314153003645 | 3        |
| RAIL-8          | 10       | 7314150511051 | 10       |
| RAUNI           | 6        | 7311518339289 | 6        |
| RB-SET-AL06-5P  | 1        | 7314150501489 | 1        |
| RB-SET-M06X-10P | 1        | 7314150501557 | 1        |
| RB-SET1-M06X-5P | 1        | 7314150501588 | 1        |
| RB-SET2-M06X-5P | 1        | 7314150501618 | 1        |
| RBCP            | 10       | 7311518339272 | 10       |
| RBCP230         | 12       | 7311518341558 | 12       |
| RCAM30          | 20       | 7311518346959 | 20       |
| RCAM36          | 20       | 7311518346973 | 20       |
| RD1M            | 15       | 7311518341534 | 15       |
| RD7M            | 20       | 7311518341541 | 20       |
| RPL230G         | 8        | 7311518341527 | 8        |
| RT821P          | 1        | 7311518242237 | 1        |
| RT822P          | 1        | 7311518234102 | 1        |
| RT823P          | 6        | 7311518234119 | 6        |
| RT824P          | 1        | 7311518240776 | 1        |
| RT825P          | 6        | 7311518347147 | 6        |
| RX 01           | 1        | 7314150103263 | 1        |
| RX 7390         | 10       | 7314150342587 | 10       |
| RX 7392         | 10       | 7314150342594 | 10       |
| RX 7490         | 10       | 7314150103195 | 10       |
| RX 7590         | 10       | 7314150103201 | 10       |
| RX 7890         | 10       | 7314150103218 | 10       |
| RX 7891         | 10       | 7314150103225 | 10       |
| RX 7892         | 10       | 7314150103232 | 10       |
| RX 7893         | 10       | 7314150103249 | 10       |
| RX 7894         | 10       | 7314150212101 | 10       |
| RX 8130         | 10       | 7314150103003 | 10       |
| RX 8131         | 10       | 7314150103010 | 10       |
| RX 8132         | 10       | 7314150103027 | 10       |
| RX 8137         | 10       | 7314150392926 | 10       |
| RX 8140         | 10       | 7314150103034 | 10       |

| Part Number | Quantity | Part Number   | Quantity |
|-------------|----------|---------------|----------|
| RX 8141     | 10       | 7314150103041 | 10       |
| RX 8142     | 10       | 7314150103058 | 10       |
| RX 8142PS   | 10       | 7314150349371 | 10       |
| RX 8143     | 10       | 7314150103065 | 10       |
| RX 8144     | 10       | 7314150103072 | 10       |
| RX 8145     | 10       | 7314150103089 | 10       |
| RX 8146     | 10       | 7314150103096 | 10       |
| RX 8147     | 10       | 7314150103102 | 10       |
| RX 8147PS   | 10       | 7314150425402 | 10       |
| RX 8148     | 10       | 7314150103119 | 10       |
| RX 8149     | 10       | 7314150103126 | 10       |
| RX 8150     | 10       | 7314150103133 | 10       |
| RX 8151     | 10       | 7314150103140 | 10       |
| RX 8152     | 10       | 7314150103157 | 10       |
| RX 8153     | 10       | 7314150412976 | 10       |
| RX 8154     | 10       | 7314150351435 | 10       |
| RX 8156     | 10       | 7314150411528 | 10       |
| RX 8157     | 10       | 7314150383733 | 10       |
| RX 8158     | 10       | 7314150117130 | 10       |
| RX 8160     | 10       | 7314150111534 | 10       |
| RX 8161     | 10       | 7314150111541 | 10       |
| RX 8161PS   | 10       | 7314150410750 | 10       |
| RX 8162     | 10       | 7314150111558 | 10       |
| RX 8164     | 10       | 7314150116270 | 10       |
| RX 8165     | 10       | 7314150116287 | 10       |
| RX 8167     | 10       | 7314150383726 | 10       |
| RX 8168     | 10       | 7314150115495 | 10       |
| RX 8211     | 10       | 7314150103188 | 10       |
| RX 8247     | 10       | 7314150103164 | 10       |
| RX 8248     | 10       | 7314150103171 | 10       |
| RX112A-0.3  | 5        | 7314150411498 | 5        |
| RX112A-1.0  | 10       | 7314150384020 | 10       |
| RX112A-1.5  | 10       | 7314150352425 | 10       |
| RX112A-2.0  | 10       | 7314150384037 | 10       |
| RX304D      | 5        | 7314150476701 | 5        |
| RX331A      | 10       | 7314150434725 | 10       |
| RX8133      | 10       | 7314150476749 | 10       |
| RX8134      | 10       | 7314150476756 | 10       |
| RX8135      | 10       | 7314150476763 | 10       |
| RX8136      | 10       | 7314150476770 | 10       |
| RX8137MX    | 10       | 7314150358519 | 10       |
| RX8138      | 10       | 7314150346561 | 10       |
| RX8138MX    | 10       | 7314150349395 | 10       |
| RX8140M2    | 10       | 7314150476787 | 10       |
| RX8140PS    | 10       | 7314150360635 | 10       |
| RX8141PS    | 10       | 7314150349432 | 10       |
| RX8143PS    | 10       | 7314150360642 | 10       |
| RX8150M2    | 10       | 7314150476794 | 10       |
| RX8150PS    | 10       | 7314150358502 | 10       |
| RX8155      | 10       | 7314150374014 | 10       |
| RX8160BPS   | 10       | 7314150360048 | 10       |
| RX8160M2    | 10       | 7314150476800 | 10       |
| RX8163      | 10       | 7314150476817 | 10       |
| RX8166      | 10       | 7314150476558 | 10       |
| RX8233A     | 10       | 7314150436279 | 10       |
| RX8234A     | 10       | 7314150436286 | 10       |
| RX8237A     | 10       | 7314150436293 | 10       |
| S0810L      | 20       | 7314150256594 | 20       |
| S103        | 2        | 7314150257119 | 2        |
| S103-CASE   | 1        | 7314150321261 | 1        |
| S106        | 2        | 7314150103997 | 2        |
| S108        | 2        | 7314150122257 | 2        |
| S108-CASE   | 1        | 7314150349319 | 1        |
| S1214L      | 10       | 7314150256600 | 10       |
| S137        | 2        | 7314150450503 | 2        |
| S138        | 2        | 7314150195022 | 2        |
| S140T       | 1        | 7314150125203 | 1        |
| S140T-R     | 10       | 7314150136353 | 10       |
| S160        | 6        | 7314150104031 | 6        |
| S160AF      | 6        | 7314150137510 | 6        |
| S1612L      | 4        | 7314150256617 | 4        |
| S18HEX      | 4        | 7314150412457 | 4        |
| S18TORX     | 4        | 7314150412464 | 4        |
| S240        | 4        | 7314150104017 | 4        |
| S240AF      | 4        | 7314150111077 | 4        |
| S240AF-CASE | 1        | 7314150187317 | 1        |
| S290        | 6        | 7314153000859 | 6        |
| S330        | 6        | 7314150104024 | 6        |
| S330-CASE   | 1        | 7314150136223 | 1        |
| S330AF      | 6        | 7314150137503 | 6        |
| S330L       | 4        | 7314150256587 | 4        |
| S330L-CASE  | 1        | 7311518337674 | 1        |
| S350AF      | 2        | 7314150137527 | 2        |
| S380        | 4        | 7314150168934 | 4        |
| S400        | 2        | 7314150111053 | 2        |
| S400-CASE   | 1        | 7314150187300 | 1        |
| S410        | 2        | 7314153019370 | 2        |
| S410-CASE   | 1        | 7314150321223 | 1        |
| S460        | 6        | 7314150111060 | 6        |
| S460-CASE   | 1        | 7314150321209 | 1        |
| S4RM-12-15  | 1        | 7314150179954 | 1        |
| S4RM-16-19  | 1        | 7314150179961 | 1        |
| S4RM-21-27  | 1        | 7314150179978 | 1        |
| S4RM-30-36  | 1        | 7314150179985 | 1        |
| S4RM-4-7    | 1        | 7314150179930 | 1        |
| S4RM-8-11   | 1        | 7314150179947 | 1        |



# S4RM/3T



|                 |               |    |     |
|-----------------|---------------|----|-----|
| S4RM/3T         | 7314150117406 | 20 | 47  |
| S4RM/4T         | 7314150179916 | 1  | 48  |
| S4RM/5T         | 7314150179923 | 1  | 48  |
| S530T           | 7314150169122 | 4  | 70  |
| S560            | 7314150122264 | 4  | 63  |
| S560-CASE       | 7314150321216 | 1  | 102 |
| S800            | 7314150165599 | 2  | 62  |
| S81MIX          | 7314150180127 | 2  | 62  |
| S81MIX-CASE     | 7314150321247 | 1  | 102 |
| S87+7           | 7314150103980 | 2  | 62  |
| S910            | 7314150104000 | 2  | 62  |
| S910AF          | 7314150137541 | 2  | 63  |
| S95             | 7314150409167 | 2  | 62  |
| S9HEX           | 7314150412433 | 10 | 72  |
| S9TORX          | 7314150412440 | 10 | 72  |
| SB-2058/S26     | 7314151849498 | 1  | 168 |
| SB-2448         | 7314150136056 | 12 | 572 |
| SB-2449         | 7314150194049 | 10 | 572 |
| SB-3732-2-125   | 7314151847869 | 60 | 608 |
| SB-3732-2.5-125 | 7314151847876 | 60 | 608 |
| SB-3732-3.2-125 | 7314151847883 | 60 | 608 |
| SB-3732-4-125   | 7314151847890 | 1  | 608 |
| SB-3734N-10-150 | 7314151848101 | 1  | 607 |
| SB-3734N-2-150  | 7314151847968 | 1  | 607 |
| SB-3734N-3-150  | 7314151847975 | 1  | 607 |
| SB-3734N-4-150  | 7314151847982 | 60 | 607 |
| SB-3734N-5-150  | 7314151847999 | 1  | 607 |
| SB-3734N-6-150  | 7314151848071 | 60 | 607 |
| SB-3734N-7-150  | 7314151848088 | 1  | 607 |
| SB-3734N-8-150  | 7314151848095 | 1  | 607 |
| SB-3735N-2-100  | 7314151847906 | 1  | 606 |
| SB-3735N-4-120  | 7314151847913 | 60 | 606 |
| SB-3735N-5-120  | 7314151847920 | 1  | 606 |
| SB-3735N-6-150  | 7314151847937 | 1  | 606 |
| SB-3735N-8-150  | 7314151847944 | 1  | 606 |
| SB-3740-125     | 7314150115990 | 87 | 604 |
| SB-3740-150     | 7314150116003 | 25 | 604 |
| SB-3740-175     | 7314150116010 | 25 | 604 |
| SB-3740-200     | 7314150116027 | 25 | 604 |
| SB-3740-250     | 7314150116034 | 25 | 604 |
| SB-3740-300     | 7314150116041 | 25 | 604 |
| SB-9526/S6      | 7314150154234 | 20 | 154 |
| SB111M-10       | 7314151839864 | 1  | 40  |
| SB111M-11       | 7314151839871 | 1  | 40  |
| SB111M-12       | 7314151839888 | 1  | 40  |
| SB111M-13       | 7314151839895 | 1  | 40  |
| SB111M-14       | 7314151839901 | 1  | 40  |
| SB111M-15       | 7314151839918 | 1  | 40  |
| SB111M-16       | 7314151839925 | 1  | 41  |
| SB111M-17       | 7314151839932 | 1  | 41  |
| SB111M-18       | 7314151839949 | 1  | 41  |
| SB111M-19       | 7314151839956 | 1  | 41  |
| SB111M-20       | 7314151839963 | 1  | 41  |
| SB111M-21       | 7314151839970 | 1  | 41  |
| SB111M-22       | 7314151839987 | 1  | 41  |
| SB111M-23       | 7314151839994 | 1  | 41  |
| SB111M-24       | 7314151840006 | 1  | 41  |
| SB111M-25       | 7314151840013 | 1  | 41  |
| SB111M-26       | 7314151840020 | 1  | 41  |
| SB111M-27       | 7314151840037 | 1  | 41  |
| SB111M-28       | 7314150432103 | 1  | 41  |
| SB111M-29       | 7314151840051 | 1  | 41  |
| SB111M-30       | 7314151840068 | 1  | 41  |
| SB111M-32       | 7314151840075 | 1  | 41  |
| SB111M-5,5      | 7314151839819 | 1  | 40  |
| SB111M-6        | 7314151839826 | 1  | 40  |
| SB111M-7        | 7314151839833 | 1  | 40  |
| SB111M-8        | 7314151839840 | 1  | 40  |
| SB111M-9        | 7314151839857 | 1  | 40  |
| SB141.007.075   | 7314150282753 | 1  | 206 |
| SB141.008.075   | 7314150282760 | 1  | 206 |
| SB141.009.075   | 7314150282777 | 1  | 206 |
| SB141.010.075   | 7314150282784 | 1  | 206 |
| SB141.015.100   | 7314150282791 | 1  | 206 |
| SB141.020.100   | 7314150282807 | 1  | 206 |
| SB141.025.125   | 7314150282814 | 1  | 206 |
| SB141.027.125   | 7314150282821 | 1  | 206 |
| SB141.030.150   | 7314150282838 | 1  | 206 |
| SB141.040.150   | 7314150282845 | 1  | 206 |
| SB142.000.075   | 7314150282579 | 1  | 496 |
| SB142.001.080   | 7314150282586 | 1  | 496 |
| SB142.002.100   | 7314150282593 | 1  | 496 |
| SB142.003.150   | 7314150282609 | 1  | 496 |
| SB143.020.100   | 7314150282852 | 1  | 496 |
| SB143.025.100   | 7314150282869 | 1  | 206 |
| SB143.030.100   | 7314150282876 | 1  | 206 |
| SB143.040.100   | 7314150282883 | 1  | 206 |
| SB143.050.100   | 7314150282890 | 1  | 206 |
| SB143.060.125   | 7314150282906 | 1  | 206 |
| SB143.080.150   | 7314150282913 | 1  | 206 |
| SB144.001.100   | 7314150282951 | 1  | 206 |
| SB144.002.125   | 7314150282968 | 1  | 206 |
| SB144.003.150   | 7314150282975 | 1  | 206 |
| SB145.006.100   | 7314150282920 | 1  | 207 |
| SB146.006.100   | 7314150282937 | 1  | 207 |
| SB148.001.080   | 7314150314577 | 1  | 496 |



|                |               |   |     |
|----------------|---------------|---|-----|
| SB148.002.100  | 7314150314584 | 1 | 496 |
| SB149.001.080  | 7314150314591 | 1 | 496 |
| SB149.002.100  | 7314150314607 | 1 | 496 |
| SB150.010.100  | 7314150343492 | 1 | 496 |
| SB150.015.125  | 7314150343515 | 1 | 496 |
| SB150.020.125  | 7314150343577 | 1 | 496 |
| SB150.025.150  | 7314150343584 | 1 | 496 |
| SB190.040.075  | 7314150281985 | 1 | 204 |
| SB190.040.100  | 7314150282098 | 1 | 204 |
| SB190.055.100  | 7314150281992 | 1 | 204 |
| SB190.055.125  | 7314150282005 | 1 | 204 |
| SB190.065.125  | 7314150282012 | 1 | 204 |
| SB190.065.150  | 7314150282029 | 1 | 204 |
| SB190.080.150  | 7314150282036 | 1 | 204 |
| SB190.080.175  | 7314150282043 | 1 | 204 |
| SB190.100.200  | 7314150282050 | 1 | 204 |
| SB190.120.250  | 7314150282067 | 1 | 204 |
| SB190.140.250  | 7314150282074 | 1 | 204 |
| SB191.025.075  | 7314150282081 | 1 | 204 |
| SB191.030.075  | 7314150282104 | 1 | 204 |
| SB191.030.100  | 7314150282111 | 1 | 204 |
| SB191.030.200  | 7314150282128 | 1 | 204 |
| SB191.035.100  | 7314150282135 | 1 | 204 |
| SB191.040.100  | 7314150282142 | 1 | 204 |
| SB191.040.125  | 7314150282159 | 1 | 204 |
| SB191.040.250  | 7314150282166 | 1 | 204 |
| SB191.055.125  | 7314150282173 | 1 | 204 |
| SB191.055.150  | 7314150282180 | 1 | 204 |
| SB191.055.300  | 7314150282197 | 1 | 204 |
| SB191.065.150  | 7314150282203 | 1 | 204 |
| SB191.065.300  | 7314150282210 | 1 | 204 |
| SB192.000.075  | 7314150282357 | 1 | 205 |
| SB192.000.200  | 7314150282364 | 1 | 205 |
| SB192.001.100  | 7314150282371 | 1 | 205 |
| SB192.001.250  | 7314150282388 | 1 | 205 |
| SB192.002.125  | 7314150282395 | 1 | 205 |
| SB192.002.300  | 7314150282401 | 1 | 205 |
| SB192.003.150  | 7314150282418 | 1 | 205 |
| SB192.004.200  | 7314150282425 | 1 | 205 |
| SB193.000.075  | 7314150282456 | 1 | 205 |
| SB193.001.100  | 7314150282463 | 1 | 205 |
| SB193.002.125  | 7314150282470 | 1 | 205 |
| SB193.003.150  | 7314150282487 | 1 | 205 |
| SB193.004.200  | 7314150282494 | 1 | 205 |
| SB194.004.075  | 7314150282616 | 1 | 206 |
| SB194.005.075  | 7314150282623 | 1 | 206 |
| SB194.006.075  | 7314150282630 | 1 | 206 |
| SB194.007.075  | 7314150282647 | 1 | 206 |
| SB194.008.075  | 7314150282654 | 1 | 206 |
| SB194.009.075  | 7314150282661 | 1 | 206 |
| SB194.010.075  | 7314150282678 | 1 | 206 |
| SB194.015.100  | 7314150282685 | 1 | 206 |
| SB194.020.100  | 7314150282692 | 1 | 206 |
| SB194.025.125  | 7314150282708 | 1 | 206 |
| SB194.027.125  | 7314150282715 | 1 | 206 |
| SB194.030.150  | 7314150282722 | 1 | 206 |
| SB194.040.150  | 7314150282739 | 1 | 206 |
| SB194.045.150  | 7314150282746 | 1 | 206 |
| SB195.001.025  | 7314150282432 | 1 | 205 |
| SB195.002.025  | 7314150282449 | 1 | 205 |
| SB195.006.050  | 7314150289516 | 1 | 207 |
| SB195.040.025  | 7314150282227 | 1 | 204 |
| SB195.050.025  | 7314150282234 | 1 | 204 |
| SB195.060.025  | 7314150282241 | 1 | 204 |
| SB195.901.025  | 7314150282500 | 1 | 205 |
| SB195.902.025  | 7314150282517 | 1 | 205 |
| SB1952M-10     | 7314150105205 | 1 | 43  |
| SB1952M-12     | 7314150105229 | 1 | 43  |
| SB1952M-13     | 7314150105236 | 1 | 43  |
| SB1952M-14     | 7314150105243 | 1 | 43  |
| SB1952M-17     | 7314150105274 | 1 | 43  |
| SB1952M-19     | 7314150105298 | 1 | 43  |
| SB1952M-24     | 7314150105342 | 1 | 43  |
| SB1952M-7      | 7314150105441 | 1 | 43  |
| SB1952M-8      | 7314150105458 | 1 | 43  |
| SB196.025.075  | 7314150282258 | 1 | 495 |
| SB196.030.100  | 7314150282265 | 1 | 495 |
| SB196.035.100  | 7314150282272 | 1 | 495 |
| SB196.040.100  | 7314150282289 | 1 | 495 |
| SB196.055.125  | 7314150282296 | 1 | 495 |
| SB196.065.150  | 7314150282302 | 1 | 495 |
| SB196.080.175  | 7314150282326 | 1 | 495 |
| SB196.100.200  | 7314150282333 | 1 | 495 |
| SB196.120.200  | 7314150282340 | 1 | 495 |
| SB197.000.075  | 7314150282524 | 1 | 496 |
| SB197.001.080  | 7314150282531 | 1 | 496 |
| SB197.002.100  | 7314150282548 | 1 | 496 |
| SB197.003.150  | 7314150282555 | 1 | 496 |
| SB197.004.200  | 7314150282562 | 1 | 496 |
| SB198.040.125  | 7314150282982 | 1 | 207 |
| SB198.045.125  | 7314150282999 | 1 | 207 |
| SB198.050.150  | 7314150283002 | 1 | 207 |
| SB198.055.150  | 7314150283019 | 1 | 207 |
| SB198.060.150  | 7314150283026 | 1 | 207 |
| SB198.060.150F | 7314150283033 | 1 | 207 |
| SB198.070.150  | 7314150283040 | 1 | 207 |





|                |               |     |     |
|----------------|---------------|-----|-----|
| SB198.070.150F | 7314150283057 | 1   | 207 |
| SB198.080.150  | 7314150283064 | 1   | 207 |
| SB198.080.150F | 7314150283071 | 1   | 207 |
| SB198.090.150  | 7314150283088 | 1   | 207 |
| SB198.100.150  | 7314150283095 | 1   | 207 |
| SB198.110.150  | 7314150283101 | 1   | 207 |
| SB198.120.150  | 7314150283118 | 1   | 207 |
| SB198.130.150  | 7314150283125 | 1   | 207 |
| SB198.140.150  | 7314150283132 | 1   | 207 |
| SB199.055.125  | 7314150283149 | 1   | 496 |
| SB199.060.125  | 7314150283156 | 1   | 496 |
| SB199.070.125  | 7314150283163 | 1   | 496 |
| SB199.080.125  | 7314150283170 | 1   | 496 |
| SB199.090.125  | 7314150283187 | 1   | 496 |
| SB199.100.125  | 7314150283194 | 1   | 496 |
| SB199.110.125  | 7314150283200 | 1   | 496 |
| SB199.120.125  | 7314150287765 | 1   | 496 |
| SB199.130.125  | 7314150287796 | 1   | 496 |
| SB2446-EL      | 7314150312207 | 10  | 584 |
| SB2446-LAP     | 7314150539475 | 10  | 583 |
| SB27M-10-11    | 7314150180851 | 10  | 58  |
| SB27M-12-13    | 7314150180868 | 10  | 58  |
| SB27M-14-15    | 7314150180875 | 10  | 58  |
| SB27M-16-17    | 7314150180882 | 10  | 58  |
| SB27M-18-19    | 7314150180899 | 10  | 58  |
| SB27M-20-22    | 7314150180905 | 10  | 58  |
| SB27M-21-23    | 7314150180912 | 5   | 58  |
| SB27M-24-26    | 7314150180929 | 5   | 58  |
| SB27M-6-7      | 7314150180837 | 10  | 58  |
| SB27M-8-9      | 7314150180844 | 10  | 58  |
| SB28M-10       | 7314150485987 | 10  | 56  |
| SB28M-11       | 7314150486007 | 10  | 56  |
| SB28M-12       | 7314150486021 | 10  | 56  |
| SB28M-13       | 7314150486045 | 10  | 56  |
| SB28M-14       | 7314150486052 | 10  | 56  |
| SB28M-15       | 7314150486076 | 10  | 56  |
| SB28M-16       | 7314150486090 | 5   | 56  |
| SB28M-17       | 7314150486113 | 5   | 56  |
| SB28M-18       | 7314150486137 | 5   | 56  |
| SB28M-19       | 7314150486151 | 5   | 56  |
| SB28M-20       | 7314150486854 | 4   | 56  |
| SB28M-21       | 7314150486878 | 4   | 56  |
| SB28M-22       | 7314150486892 | 4   | 56  |
| SB28M-23       | 7314150486915 | 4   | 56  |
| SB28M-24       | 7314150486939 | 4   | 56  |
| SB28M-6        | 7314150486175 | 10  | 56  |
| SB28M-7        | 7314150486199 | 10  | 56  |
| SB28M-8        | 7314150486212 | 10  | 56  |
| SB28M-9        | 7314150486236 | 10  | 56  |
| SB3654BM-15    | 7314150270897 | 5   | 610 |
| SB3654BM-20    | 7314150270903 | 5   | 610 |
| SB3734BM-10    | 7314150271092 | 5   | 610 |
| SB3734BM-3     | 7314150270996 | 5   | 610 |
| SB3734BM-4     | 7314150271016 | 5   | 610 |
| SB3734BM-5     | 7314150271030 | 5   | 610 |
| SB3734BM-6     | 7314150271054 | 5   | 610 |
| SB3734BM-8     | 7314150271078 | 5   | 610 |
| SB3755BM-4     | 7314150270934 | 610 | 610 |
| SB3755BM-6     | 7314150270958 | 5   | 610 |
| SB6700SM-10    | 7314150104383 | 1   | 78  |
| SB6700SM-11    | 7314150104390 | 1   | 78  |
| SB6700SM-12    | 7314150104406 | 1   | 78  |
| SB6700SM-13    | 7314150104413 | 1   | 78  |
| SB6700SM-14    | 7314150104420 | 1   | 78  |
| SB6700SM-4     | 7314150104307 | 1   | 78  |
| SB6700SM-4.5   | 7314150104314 | 1   | 78  |
| SB6700SM-5     | 7314150104321 | 1   | 78  |
| SB6700SM-5.5   | 7314150104338 | 1   | 78  |
| SB6700SM-6     | 7314150104345 | 1   | 78  |
| SB6700SM-7     | 7314150104352 | 1   | 78  |
| SB6700SM-8     | 7314150104369 | 1   | 78  |
| SB6700SM-9     | 7314150104376 | 1   | 78  |
| SB6700SZ-1/2   | 7314150240609 | 1   | 78  |
| SB6700SZ-1/4   | 7314150240616 | 1   | 78  |
| SB6700SZ-1/8   | 7314150412495 | 5   | 78  |
| SB6700SZ-11/32 | 7314150240623 | 1   | 78  |
| SB6700SZ-3/16  | 7314150240630 | 1   | 78  |
| SB6700SZ-3/8   | 7314150240647 | 1   | 78  |
| SB6700SZ-5/16  | 7314150240654 | 1   | 78  |
| SB6700SZ-5/32  | 7314150240661 | 1   | 78  |
| SB6700SZ-7/16  | 7314150240678 | 1   | 78  |
| SB6700SZ-7/32  | 7314150240685 | 1   | 78  |
| SB6700SZ-9/16  | 7314150240692 | 1   | 78  |
| SB6700SZ-9/32  | 7314150240708 | 1   | 78  |
| SB6700TORX-E10 | 7314150240715 | 1   | 78  |
| SB6700TORX-E4  | 7314150240722 | 1   | 78  |
| SB6700TORX-E5  | 7314150240739 | 1   | 78  |
| SB6700TORX-E6  | 7314150240746 | 1   | 78  |
| SB6700TORX-E7  | 7314150240753 | 1   | 78  |
| SB6700TORX-E8  | 7314150240760 | 1   | 78  |
| SB6709F-4.5    | 7314150240777 | 1   | 82  |
| SB6709F-5.5    | 7314150240784 | 1   | 82  |
| SB6709F-6.5    | 7314150240791 | 1   | 82  |
| SB6709F-8      | 7314150240807 | 1   | 82  |
| SB67M-3        | 7314150290055 | 1   | 83  |
| SB6709M-4      | 7314150240821 | 1   | 83  |



|                  |               |    |     |
|------------------|---------------|----|-----|
| SB6709M-5        | 7314150240838 | 1  | 83  |
| SB6709M-6        | 7314150240845 | 1  | 83  |
| SB6709M-8        | 7314150240852 | 1  | 83  |
| SB6709PH-1       | 7314150240869 | 1  | 82  |
| SB6709PH-2       | 7314150240876 | 1  | 82  |
| SB6709PH-3       | 7314150240883 | 1  | 82  |
| SB6709PZ-1       | 7314150240890 | 1  | 83  |
| SB6709PZ-2       | 7314150240906 | 1  | 83  |
| SB6709PZ-3       | 7314150240913 | 1  | 83  |
| SB6709TORX-R-T10 | 7314150240975 | 1  | 83  |
| SB6709TORX-R-T15 | 7314150240937 | 1  | 83  |
| SB6709TORX-R-T20 | 7314150240944 | 1  | 83  |
| SB6709TORX-R-T25 | 7314150240951 | 1  | 83  |
| SB6709TORX-R-T8  | 7314150240968 | 1  | 83  |
| SB6709TORX-T10   | 7314150240982 | 1  | 83  |
| SB6709TORX-T15   | 7314150240999 | 1  | 83  |
| SB6709TORX-T20   | 7314150241002 | 1  | 83  |
| SB6709TORX-T25   | 7314150241019 | 1  | 83  |
| SB6709TORX-T27   | 7314150241026 | 1  | 83  |
| SB6709TORX-T30   | 7314150241033 | 1  | 83  |
| SB6709TORX-T40   | 7314150241040 | 1  | 83  |
| SB6709TORX-T8    | 7314150241057 | 1  | 83  |
| SB6709TORX-T9    | 7314150241064 | 1  | 83  |
| SB6950           | 7314150104987 | 1  | 84  |
| SB6950RN         | 7314150104994 | 1  | 84  |
| SB6954-5         | 7314150512188 | 10 | 80  |
| SB6956           | 7314150241071 | 1  | 80  |
| SB6958-6         | 7314150500833 | 1  | 80  |
| SB6960           | 7314150104925 | 1  | 81  |
| SB6960-3         | 7314150512225 | 1  | 81  |
| SB6961           | 7314150104932 | 1  | 81  |
| SB6962           | 7314150104949 | 1  | 81  |
| SB6962L          | 7314150254743 | 1  | 81  |
| SB6963           | 7314150241088 | 1  | 81  |
| SB6966           | 7314150241095 | 1  | 81  |
| SB6973A          | 7314150507214 | 1  | 82  |
| SB6M-10-11       | 7314150105731 | 1  | 48  |
| SB6M-12-13       | 7314150105762 | 1  | 48  |
| SB6M-14-15       | 7314150105823 | 1  | 48  |
| SB6M-16-17       | 7314150105847 | 1  | 48  |
| SB6M-17-19       | 7314150189830 | 1  | 48  |
| SB6M-18-19       | 7314150105878 | 1  | 48  |
| SB6M-20-22       | 7314150105915 | 1  | 48  |
| SB6M-21-23       | 7314150105922 | 1  | 48  |
| SB6M-22-24       | 7314150105946 | 1  | 48  |
| SB6M-24-26       | 7314150105953 | 1  | 48  |
| SB6M-24-27       | 7314150105960 | 1  | 48  |
| SB6M-25-28       | 7314150189847 | 1  | 48  |
| SB6M-27-29       | 7314150189854 | 1  | 48  |
| SB6M-30-32       | 7314150106011 | 1  | 48  |
| SB6M-4-5         | 7314150106042 | 1  | 48  |
| SB6M-6-7         | 7314150106073 | 1  | 48  |
| SB6M-8-9         | 7314150106103 | 1  | 48  |
| SB705.1/4.125    | 7314150283231 | 1  | 216 |
| SB7400SM-10      | 7314150241101 | 1  | 85  |
| SB7400SM-11      | 7314150241118 | 1  | 85  |
| SB7400SM-12      | 7314150241125 | 1  | 85  |
| SB7400SM-13      | 7314150241132 | 1  | 85  |
| SB7400SM-14      | 7314150241149 | 1  | 85  |
| SB7400SM-15      | 7314150241156 | 1  | 85  |
| SB7400SM-16      | 7314150241170 | 1  | 85  |
| SB7400SM-17      | 7314150241187 | 1  | 85  |
| SB7400SM-18      | 7314150241194 | 1  | 85  |
| SB7400SM-19      | 7314150241200 | 1  | 85  |
| SB7400SM-20      | 7314150241217 | 1  | 85  |
| SB7400SM-21      | 7314150241224 | 1  | 85  |
| SB7400SM-22      | 7314150241231 | 1  | 85  |
| SB7400SM-6       | 7314150241248 | 1  | 85  |
| SB7400SM-7       | 7314150241255 | 1  | 85  |
| SB7400SM-8       | 7314150241262 | 1  | 85  |
| SB7400SM-9       | 7314150241279 | 1  | 85  |
| SB7400TORX-E10   | 7314150241286 | 1  | 86  |
| SB7400TORX-E11   | 7314150241293 | 1  | 86  |
| SB7400TORX-E12   | 7314150241309 | 1  | 86  |
| SB7400TORX-E14   | 7314150241316 | 1  | 86  |
| SB7400TORX-E16   | 7314150241323 | 1  | 86  |
| SB7400TORX-E18   | 7314150241330 | 1  | 86  |
| SB7400TORX-E8    | 7314150241347 | 1  | 86  |
| SB7409BH-10      | 7314150241354 | 1  | 90  |
| SB7409BH-4       | 7314150241361 | 1  | 90  |
| SB7409BH-5       | 7314150241378 | 1  | 90  |
| SB7409BH-6       | 7314150241385 | 1  | 90  |
| SB7409BH-8       | 7314150241392 | 1  | 90  |
| SB7409F-10       | 7314150241408 | 1  | 89  |
| SB7409F-6.5      | 7314150241415 | 1  | 89  |
| SB7409F-8        | 7314150241422 | 1  | 89  |
| SB7409M-10       | 7314150241439 | 1  | 90  |
| SB7409M-3        | 7314150241446 | 1  | 90  |
| SB7409M-4        | 7314150241453 | 1  | 90  |
| SB7409M-5        | 7314150241460 | 1  | 90  |
| SB7409M-6        | 7314150241477 | 1  | 90  |
| SB7409M-7        | 7314150241484 | 1  | 90  |
| SB7409M-8        | 7314150241491 | 1  | 90  |
| SB7409PH-1       | 7314150241507 | 1  | 89  |
| SB7409PH-2       | 7314150241514 | 1  | 89  |
| SB7409PH-3       | 7314150241521 | 1  | 89  |



# SB7409TORX-R-T27



|                  |               |    |    |
|------------------|---------------|----|----|
| SB7409TORX-R-T27 | 7314150241538 | 1  | 89 |
| SB7409TORX-R-T30 | 7314150241545 | 1  | 89 |
| SB7409TORX-R-T40 | 7314150241552 | 1  | 89 |
| SB7409TORX-R-T45 | 7314150241569 | 1  | 89 |
| SB7409TORX-R-T50 | 7314150241576 | 1  | 89 |
| SB7409TORX-T20   | 7314150241583 | 1  | 89 |
| SB7409TORX-T25   | 7314150241590 | 1  | 89 |
| SB7409TORX-T25-L | 7314150241606 | 1  | 90 |
| SB7409TORX-T27   | 7314150241613 | 1  | 89 |
| SB7409TORX-T30   | 7314150241620 | 1  | 89 |
| SB7409TORX-T30-L | 7314150241637 | 1  | 90 |
| SB7409TORX-T40   | 7314150241644 | 1  | 89 |
| SB7409TORX-T40-L | 7314150241651 | 1  | 90 |
| SB7409TORX-T45   | 7314150241668 | 1  | 89 |
| SB7409TORX-T45-L | 7314150241675 | 1  | 90 |
| SB7409TORX-T50   | 7314150241682 | 1  | 89 |
| SB7409TORX-T50-L | 7314150241699 | 1  | 90 |
| SB7750           | 7314150187850 | 1  | 88 |
| SB7750RNR        | 7314153003966 | 1  | 88 |
| SB7754           | 7314150250165 | 1  | 87 |
| SB7756           | 7314150489176 | 1  | 87 |
| SB7758-10        | 7314150500840 | 1  | 87 |
| SB7759           | 7314150254859 | 1  | 87 |
| SB7760           | 7314153003980 | 1  | 87 |
| SB7761           | 7314150241705 | 1  | 87 |
| SB7762           | 7314153004000 | 1  | 87 |
| SB7764           | 7314150241729 | 1  | 88 |
| SB7765           | 7314150241736 | 50 | 81 |
| SB7766           | 7314150241743 | 1  | 87 |
| SB7767           | 7314150254897 | 1  | 82 |
| SB7773A          | 7314150516209 | 1  | 88 |
| SB7800DM-10      | 7314150104451 | 1  | 92 |
| SB7800DM-11      | 7314150104468 | 1  | 92 |
| SB7800DM-12      | 7314150104475 | 1  | 92 |
| SB7800DM-13      | 7314150104482 | 1  | 92 |
| SB7800DM-14      | 7314150104499 | 1  | 92 |
| SB7800DM-15      | 7314150104505 | 1  | 92 |
| SB7800DM-16      | 7314150104512 | 1  | 92 |
| SB7800DM-17      | 7314150104529 | 1  | 92 |
| SB7800DM-18      | 7314150104536 | 1  | 92 |
| SB7800DM-19      | 7314150104543 | 1  | 92 |
| SB7800DM-20      | 7314150104550 | 1  | 92 |
| SB7800DM-21      | 7314150104567 | 1  | 92 |
| SB7800DM-22      | 7314150104574 | 1  | 92 |
| SB7800DM-23      | 7314150104581 | 1  | 92 |
| SB7800DM-24      | 7314150104598 | 1  | 92 |
| SB7800DM-25      | 7314150104604 | 1  | 92 |
| SB7800DM-26      | 7314150104611 | 1  | 92 |
| SB7800DM-27      | 7314150104628 | 1  | 92 |
| SB7800DM-28      | 7314150104635 | 1  | 92 |
| SB7800DM-29      | 7314150104642 | 1  | 92 |
| SB7800DM-30      | 7314150104659 | 1  | 92 |
| SB7800DM-31      | 7314150471171 | 1  | 92 |
| SB7800DM-32      | 7314150104666 | 1  | 92 |
| SB7800DM-33      | 7314150240319 | 1  | 92 |
| SB7800DM-34      | 7314150327607 | 1  | 92 |
| SB7800DM-36      | 7314150104673 | 1  | 92 |
| SB7800DM-8       | 7314150104437 | 1  | 92 |
| SB7800DM-9       | 7314150104444 | 1  | 92 |
| SB7800DZ-1       | 7314150234912 | 1  | 92 |
| SB7800DZ-1.1/16  | 7314150240326 | 1  | 92 |
| SB7800DZ-1.1/4   | 7314150240333 | 1  | 92 |
| SB7800DZ-1.1/8   | 7314150240340 | 1  | 92 |
| SB7800DZ-1.3/16  | 7314150240357 | 1  | 92 |
| SB7800DZ-1.5/16  | 7314150240364 | 1  | 92 |
| SB7800DZ-1/2     | 7314150234899 | 1  | 92 |
| SB7800DZ-11/16   | 7314150234929 | 1  | 92 |
| SB7800DZ-13/16   | 7314150234936 | 1  | 92 |
| SB7800DZ-15/16   | 7314150234943 | 1  | 92 |
| SB7800DZ-19/32   | 7314150240371 | 1  | 92 |
| SB7800DZ-25/32   | 7314150240388 | 1  | 92 |
| SB7800DZ-3/4     | 7314150234950 | 1  | 92 |
| SB7800DZ-3/8     | 7314150234967 | 1  | 92 |
| SB7800DZ-5/8     | 7314150234974 | 1  | 92 |
| SB7800DZ-7/16    | 7314150234981 | 1  | 92 |
| SB7800DZ-7/8     | 7314150234998 | 1  | 92 |
| SB7800DZ-9/16    | 7314150235001 | 1  | 92 |
| SB7800SM-10      | 7314150104703 | 1  | 91 |
| SB7800SM-11      | 7314150104710 | 1  | 91 |
| SB7800SM-12      | 7314150104727 | 1  | 91 |
| SB7800SM-13      | 7314150104734 | 1  | 91 |
| SB7800SM-14      | 7314150104741 | 1  | 91 |
| SB7800SM-15      | 7314150104758 | 1  | 91 |
| SB7800SM-16      | 7314150104765 | 1  | 91 |
| SB7800SM-17      | 7314150104772 | 1  | 91 |
| SB7800SM-18      | 7314150104789 | 1  | 91 |
| SB7800SM-19      | 7314150104796 | 1  | 91 |
| SB7800SM-20      | 7314150240395 | 1  | 91 |
| SB7800SM-21      | 7314150104819 | 1  | 91 |
| SB7800SM-22      | 7314150104826 | 1  | 91 |
| SB7800SM-23      | 7314150104833 | 1  | 91 |
| SB7800SM-24      | 7314150104840 | 1  | 91 |
| SB7800SM-25      | 7314150104857 | 1  | 91 |
| SB7800SM-26      | 7314150104864 | 1  | 91 |
| SB7800SM-27      | 7314150104871 | 1  | 91 |
| SB7800SM-28      | 7314150104888 | 1  | 91 |



|                |               |   |     |
|----------------|---------------|---|-----|
| SB7800SM-29    | 7314150240401 | 1 | 91  |
| SB7800SM-30    | 7314150104895 | 1 | 91  |
| SB7800SM-32    | 7314150104901 | 1 | 91  |
| SB7800SM-33    | 7314150240418 | 1 | 91  |
| SB7800SM-34    | 7314150235018 | 1 | 91  |
| SB7800SM-36    | 7314150235025 | 1 | 91  |
| SB7800SM-8     | 7314150104680 | 1 | 91  |
| SB7800SM-9     | 7314150104697 | 1 | 91  |
| SB7800TORX-E10 | 7314150240104 | 1 | 93  |
| SB7800TORX-E11 | 7314150240111 | 1 | 93  |
| SB7800TORX-E12 | 7314150240128 | 1 | 93  |
| SB7800TORX-E14 | 7314150240135 | 1 | 93  |
| SB7800TORX-E16 | 7314150240142 | 1 | 93  |
| SB7800TORX-E18 | 7314150240159 | 1 | 93  |
| SB7800TORX-E20 | 7314150240166 | 1 | 93  |
| SB7800TORX-E24 | 7314150240173 | 1 | 93  |
| SB7800TORX-E8  | 7314150240180 | 1 | 93  |
| SB7805DM-10    | 7314150234851 | 1 | 92  |
| SB7805DM-12    | 7314150234868 | 1 | 92  |
| SB7805DM-13    | 7314150235032 | 1 | 92  |
| SB7805DM-14    | 7314150235049 | 1 | 92  |
| SB7805DM-15    | 7314150235056 | 1 | 92  |
| SB7805DM-16    | 7314150235063 | 1 | 92  |
| SB7805DM-17    | 7314150235070 | 1 | 92  |
| SB7805DM-18    | 7314150235087 | 1 | 92  |
| SB7805DM-19    | 7314150235094 | 1 | 92  |
| SB7805DM-21    | 7314150235100 | 1 | 92  |
| SB7805DM-22    | 7314150235117 | 1 | 92  |
| SB7805DM-23    | 7314150327614 | 1 | 92  |
| SB7805DM-24    | 7314150235124 | 1 | 93  |
| SB7805DM-26    | 7314150240197 | 1 | 93  |
| SB7805DM-27    | 7314150235131 | 1 | 93  |
| SB7805DM-30    | 7314150235148 | 1 | 93  |
| SB7805DM-32    | 7314150240203 | 1 | 93  |
| SB7805DM-34    | 7314150521852 | 1 | 93  |
| SB7805SM-10    | 7314150235155 | 1 | 91  |
| SB7805SM-11    | 7314150524501 | 1 | 91  |
| SB7805SM-12    | 7314150235162 | 1 | 91  |
| SB7805SM-13    | 7314150235179 | 1 | 91  |
| SB7805SM-14    | 7314150235193 | 1 | 91  |
| SB7805SM-15    | 7314150235216 | 1 | 91  |
| SB7805SM-16    | 7314150240210 | 1 | 91  |
| SB7805SM-17    | 7314150235223 | 1 | 91  |
| SB7805SM-18    | 7314150235230 | 1 | 91  |
| SB7805SM-19    | 7314150235247 | 1 | 91  |
| SB7805SM-20    | 7314150240227 | 1 | 91  |
| SB7805SM-21    | 7314150235254 | 1 | 91  |
| SB7805SM-22    | 7314150235261 | 1 | 91  |
| SB7805SM-23    | 7314150240234 | 1 | 91  |
| SB7805SM-24    | 7314150235278 | 1 | 91  |
| SB7805SM-25    | 7314150240241 | 1 | 91  |
| SB7805SM-26    | 7314150240258 | 1 | 91  |
| SB7805SM-27    | 7314150235285 | 1 | 91  |
| SB7805SM-28    | 7314150240265 | 1 | 91  |
| SB7805SM-29    | 7314150240272 | 1 | 91  |
| SB7805SM-30    | 7314150235292 | 1 | 91  |
| SB7805SM-32    | 7314150235308 | 1 | 91  |
| SB7805SM-34    | 7314150498284 | 1 | 91  |
| SB7807H        | 7314150467297 | 1 | 177 |
| SB7808H        | 7314150467303 | 1 | 177 |
| SB7809H        | 7314150467341 | 1 | 177 |
| SB7809M-10     | 7314153004185 | 1 | 96  |
| SB7809M-12     | 7314153004208 | 1 | 96  |
| SB7809M-14     | 7314153004215 | 1 | 96  |
| SB7809M-17     | 7314153004222 | 1 | 96  |
| SB7809M-19     | 7314153004239 | 1 | 96  |
| SB7809M-4      | 7314150313952 | 1 | 96  |
| SB7809M-5      | 7314153004109 | 1 | 96  |
| SB7809M-5-180  | 7314153004116 | 1 | 96  |
| SB7809M-6      | 7314153004123 | 1 | 96  |
| SB7809M-7      | 7314153004130 | 1 | 96  |
| SB7809M-7-100  | 7314153004147 | 1 | 96  |
| SB7809M-8      | 7314153004154 | 1 | 96  |
| SB7809M-8-120  | 7314153004161 | 1 | 96  |
| SB7809M-9      | 7314153004178 | 1 | 96  |
| SB7809TORX-T20 | 7314153004017 | 1 | 95  |
| SB7809TORX-T25 | 7314153004024 | 1 | 95  |
| SB7809TORX-T27 | 7314153004031 | 1 | 95  |
| SB7809TORX-T30 | 7314153004048 | 1 | 95  |
| SB7809TORX-T40 | 7314153004055 | 1 | 95  |
| SB7809TORX-T45 | 7314153004062 | 1 | 95  |
| SB7809TORX-T50 | 7314153004079 | 1 | 95  |
| SB7809TORX-T55 | 7314153004086 | 1 | 95  |
| SB7809TORX-T60 | 7314153004093 | 1 | 95  |
| SB8150-1/2     | 7314150105014 | 1 | 97  |
| SB8150RN-1/2   | 7314150105007 | 1 | 97  |
| SB8154-11      | 7314150472178 | 1 | 93  |
| SB8157-10      | 7314150474073 | 1 | 93  |
| SB8157-15      | 7314150472468 | 1 | 93  |
| SB8157-24      | 7314150474080 | 1 | 93  |
| SB8157-36      | 7314150474097 | 1 | 93  |
| SB8158-10      | 7314150488780 | 1 | 93  |
| SB8158-15      | 7314150488797 | 1 | 93  |
| SB8160-10      | 7314150472185 | 1 | 93  |
| SB8160-3       | 7314150472192 | 1 | 93  |
| SB8160-5       | 7314150472208 | 1 | 93  |

|                 |               |   |    |
|-----------------|---------------|---|----|
| SB8166          | 7314150472154 | 1 | 94 |
| SB8171          | 7314150479016 | 1 | 94 |
| SB8172          | 7314150479023 | 1 | 94 |
| SBA6700DM-10    | 7314150235575 | 1 | 79 |
| SBA6700DM-11    | 7314150241750 | 1 | 79 |
| SBA6700DM-12    | 7314150241767 | 1 | 79 |
| SBA6700DM-13    | 7314150241774 | 1 | 79 |
| SBA6700DM-14    | 7314150241781 | 1 | 79 |
| SBA6700DM-5     | 7314150255054 | 1 | 79 |
| SBA6700DM-5.5   | 7314150241798 | 1 | 79 |
| SBA6700DM-6     | 7314150241804 | 1 | 79 |
| SBA6700DM-7     | 7314150241811 | 1 | 79 |
| SBA6700DM-8     | 7314150241828 | 1 | 79 |
| SBA6700DM-9     | 7314150241835 | 1 | 79 |
| SBA6700DZ-1/2   | 7314150241842 | 1 | 79 |
| SBA6700DZ-1/4   | 7314150241859 | 1 | 79 |
| SBA6700DZ-11/32 | 7314150241866 | 1 | 79 |
| SBA6700DZ-3/16  | 7314150241873 | 1 | 79 |
| SBA6700DZ-3/8   | 7314150241880 | 1 | 79 |
| SBA6700DZ-5/16  | 7314150241897 | 1 | 79 |
| SBA6700DZ-7/16  | 7314150241903 | 1 | 79 |
| SBA6700DZ-7/32  | 7314150241910 | 1 | 79 |
| SBA6700DZ-9/16  | 7314150241927 | 1 | 79 |
| SBA6700DZ-9/32  | 7314150241934 | 1 | 79 |
| SBA6709M-2.5    | 7314150254835 | 1 | 83 |
| SBA6709M-3      | 7314150254828 | 1 | 83 |
| SBA6709M-4      | 7314150254811 | 1 | 83 |
| SBA6709M-5      | 7314150254804 | 1 | 83 |
| SBA6709M-6      | 7314150254798 | 1 | 83 |
| SBA6709Z-1/8    | 7314150254781 | 1 | 83 |
| SBA6709Z-3/16   | 7314150254774 | 1 | 83 |
| SBA6709Z-5/32   | 7314150254767 | 1 | 83 |
| SBA6709Z-9/64   | 7314150254750 | 1 | 83 |
| SBA6800DM-10    | 7314150250172 | 1 | 79 |
| SBA6800DM-11    | 7314150250189 | 1 | 79 |
| SBA6800DM-12    | 7314150250196 | 1 | 79 |
| SBA6800DM-13    | 7314150250202 | 1 | 79 |
| SBA6800DM-14    | 7314150250219 | 1 | 79 |
| SBA6800DM-4     | 7314150250226 | 1 | 79 |
| SBA6800DM-5     | 7314150250233 | 1 | 79 |
| SBA6800DM-5.5   | 7314150250240 | 1 | 79 |
| SBA6800DM-6     | 7314150250257 | 1 | 79 |
| SBA6800DM-7     | 7314150250264 | 1 | 79 |
| SBA6800DM-8     | 7314150250271 | 1 | 79 |
| SBA6800DM-9     | 7314150250288 | 1 | 79 |
| SBA6800DZ-1/2   | 7314150250295 | 1 | 80 |
| SBA6800DZ-1/4   | 7314150250301 | 1 | 80 |
| SBA6800DZ-11/32 | 7314150250318 | 1 | 80 |
| SBA6800DZ-3/16  | 7314150250325 | 1 | 80 |
| SBA6800DZ-3/8   | 7314150250332 | 1 | 80 |
| SBA6800DZ-5/16  | 7314150250349 | 1 | 80 |
| SBA6800DZ-7/16  | 7314150250356 | 1 | 80 |
| SBA6800DZ-7/32  | 7314150250363 | 1 | 80 |
| SBA6800DZ-9/16  | 7314150250370 | 1 | 80 |
| SBA6800DZ-9/32  | 7314150250387 | 1 | 80 |
| SBA7400DM-10    | 7314150241941 | 1 | 85 |
| SBA7400DM-11    | 7314150241958 | 1 | 85 |
| SBA7400DM-12    | 7314150241965 | 1 | 85 |
| SBA7400DM-13    | 7314150241972 | 1 | 85 |
| SBA7400DM-14    | 7314150241989 | 1 | 85 |
| SBA7400DM-15    | 7314150241996 | 1 | 85 |
| SBA7400DM-16    | 7314150242009 | 1 | 85 |
| SBA7400DM-17    | 7314150242016 | 1 | 85 |
| SBA7400DM-18    | 7314150242023 | 1 | 85 |
| SBA7400DM-19    | 7314150242030 | 1 | 85 |
| SBA7400DM-20    | 7314150242047 | 1 | 85 |
| SBA7400DM-21    | 7314150242054 | 1 | 85 |
| SBA7400DM-22    | 7314150242061 | 1 | 85 |
| SBA7400DM-6     | 7314150242078 | 1 | 85 |
| SBA7400DM-7     | 7314150242085 | 1 | 85 |
| SBA7400DM-8     | 7314150242092 | 1 | 85 |
| SBA7400DM-9     | 7314150242108 | 1 | 85 |
| SBA7400DZ-1/2   | 7314150254705 | 1 | 86 |
| SBA7400DZ-1/4   | 7314150242115 | 1 | 86 |
| SBA7400DZ-11/16 | 7314150242122 | 1 | 86 |
| SBA7400DZ-13/16 | 7314150242139 | 1 | 86 |
| SBA7400DZ-17/32 | 7314150242146 | 1 | 86 |
| SBA7400DZ-19/32 | 7314150242153 | 1 | 86 |
| SBA7400DZ-3/4   | 7314150242160 | 1 | 86 |
| SBA7400DZ-3/8   | 7314150242177 | 1 | 86 |
| SBA7400DZ-5/16  | 7314150242184 | 1 | 86 |
| SBA7400DZ-5/8   | 7314150242191 | 1 | 86 |
| SBA7400DZ-7/16  | 7314150242207 | 1 | 86 |
| SBA7400DZ-7/8   | 7314150242214 | 1 | 86 |
| SBA7400DZ-9/16  | 7314150242221 | 1 | 86 |
| SBA7402DM-10    | 7314150250394 | 1 | 86 |
| SBA7402DM-11    | 7314150250400 | 1 | 86 |
| SBA7402DM-12    | 7314150250417 | 1 | 86 |
| SBA7402DM-13    | 7314150250424 | 1 | 86 |
| SBA7402DM-14    | 7314150250431 | 1 | 86 |
| SBA7402DM-15    | 7314150250448 | 1 | 86 |
| SBA7402DM-16    | 7314150250455 | 1 | 86 |
| SBA7402DM-17    | 7314150250462 | 1 | 86 |
| SBA7402DM-18    | 7314150250479 | 1 | 86 |
| SBA7402DM-19    | 7314150250486 | 1 | 86 |
| SBA7402DM-7     | 7314150250493 | 1 | 86 |

|                 |               |   |     |
|-----------------|---------------|---|-----|
| SBA7402DM-8     | 7314150250509 | 1 | 86  |
| SBA7402DM-9     | 7314150250516 | 1 | 86  |
| SBA7402DZ-1/2   | 7314150250523 | 1 | 86  |
| SBA7402DZ-1/4   | 7314150250530 | 1 | 86  |
| SBA7402DZ-11/16 | 7314150250547 | 1 | 86  |
| SBA7402DZ-13/16 | 7314150250554 | 1 | 86  |
| SBA7402DZ-19/32 | 7314150250561 | 1 | 86  |
| SBA7402DZ-3/4   | 7314150250578 | 1 | 86  |
| SBA7402DZ-3/8   | 7314150250585 | 1 | 86  |
| SBA7402DZ-5/16  | 7314150250592 | 1 | 86  |
| SBA7402DZ-5/8   | 7314150250608 | 1 | 86  |
| SBA7402DZ-7/16  | 7314150250615 | 1 | 86  |
| SBA7402DZ-7/8   | 7314150250622 | 1 | 86  |
| SBA7402DZ-9/16  | 7314150250639 | 1 | 86  |
| SBC110-65       | 7314150456246 | 1 | 573 |
| SBE-8135TB      | 7314150320424 | 1 | 199 |
| SBE-8145TB      | 7314150320431 | 1 | 199 |
| SBE-8150TB      | 7314150320448 | 1 | 199 |
| SBE-8155TB      | 7314150320455 | 1 | 199 |
| SBE-8610TB      | 7314150320493 | 1 | 199 |
| SBE-8620TB      | 7314150320509 | 1 | 199 |
| SBE-8810TB      | 7314150320530 | 1 | 199 |
| SBE-8820TB      | 7314150320547 | 1 | 199 |
| SBE-8915TB      | 7314150320585 | 1 | 200 |
| SBE-8920TB      | 7314150320592 | 1 | 200 |
| SBE-8925TB      | 7314150320608 | 1 | 200 |
| SBE-8930TB      | 7314150320622 | 1 | 200 |
| SBE-8940TB      | 7314150320639 | 1 | 200 |
| SBK6701M-10     | 7314150445233 | 1 | 172 |
| SBK6701M-11     | 7314150445240 | 1 | 172 |
| SBK6701M-12     | 7314150445264 | 1 | 172 |
| SBK6701M-13     | 7314150445271 | 1 | 172 |
| SBK6701M-14     | 7314150445288 | 1 | 172 |
| SBK6701M-6      | 7314150445196 | 1 | 172 |
| SBK6701M-7      | 7314150445202 | 1 | 172 |
| SBK6701M-8      | 7314150445219 | 1 | 172 |
| SBK6701M-9      | 7314150445226 | 1 | 172 |
| SBK7401M-10     | 7314150445325 | 1 | 173 |
| SBK7401M-11     | 7314150445332 | 1 | 173 |
| SBK7401M-12     | 7314150445349 | 1 | 173 |
| SBK7401M-13     | 7314150445356 | 1 | 173 |
| SBK7401M-14     | 7314150445363 | 1 | 173 |
| SBK7401M-15     | 7314150445370 | 1 | 173 |
| SBK7401M-16     | 7314150445387 | 1 | 173 |
| SBK7401M-17     | 7314150445394 | 1 | 173 |
| SBK7401M-18     | 7314150445400 | 1 | 173 |
| SBK7401M-19     | 7314150445417 | 1 | 173 |
| SBK7401M-20     | 7314150445424 | 1 | 173 |
| SBK7401M-21     | 7314150445431 | 1 | 173 |
| SBK7401M-22     | 7314150445448 | 1 | 173 |
| SBK7401M-24     | 7314150445455 | 1 | 173 |
| SBK7401M-7      | 7314150445295 | 1 | 173 |
| SBK7401M-8      | 7314150445301 | 1 | 173 |
| SBK7401M-9      | 7314150445318 | 1 | 173 |
| SBK7764D        | 7314150447800 | 1 | 177 |
| SBK7801M-10     | 7314150445486 | 1 | 175 |
| SBK7801M-11     | 7314150445493 | 1 | 175 |
| SBK7801M-12     | 7314150445509 | 1 | 175 |
| SBK7801M-13     | 7314150445516 | 1 | 175 |
| SBK7801M-14     | 7314150445523 | 1 | 175 |
| SBK7801M-15     | 7314150445530 | 1 | 175 |
| SBK7801M-16     | 7314150445547 | 1 | 175 |
| SBK7801M-17     | 7314150445554 | 1 | 175 |
| SBK7801M-18     | 7314150445561 | 1 | 175 |
| SBK7801M-19     | 7314150445578 | 1 | 175 |
| SBK7801M-20     | 7314150445585 | 1 | 175 |
| SBK7801M-21     | 7314150445592 | 1 | 175 |
| SBK7801M-22     | 7314150445608 | 1 | 175 |
| SBK7801M-23     | 7314150445615 | 1 | 175 |
| SBK7801M-24     | 7314150445622 | 1 | 175 |
| SBK7801M-25     | 7314150445639 | 1 | 175 |
| SBK7801M-26     | 7314150445646 | 1 | 175 |
| SBK7801M-27     | 7314150445653 | 1 | 175 |
| SBK7801M-28     | 7314150450763 | 1 | 175 |
| SBK7801M-29     | 7314150450770 | 1 | 175 |
| SBK7801M-30     | 7314150445660 | 1 | 175 |
| SBK7801M-32     | 7314150445677 | 1 | 175 |
| SBK7801M-34     | 7314150445684 | 1 | 175 |
| SBK7801M-36     | 7314150445691 | 1 | 175 |
| SBK7801M-8      | 7314150445462 | 1 | 175 |
| SBK7801M-9      | 7314150445479 | 1 | 175 |
| SBK7801Z-1      | 7314150448036 | 1 | 176 |
| SBK7801Z-1.1/16 | 7314150448142 | 1 | 176 |
| SBK7801Z-1.1/2  | 7314150448203 | 1 | 176 |
| SBK7801Z-1.1/4  | 7314150448166 | 1 | 176 |
| SBK7801Z-1.1/8  | 7314150448159 | 1 | 176 |
| SBK7801Z-1.3/8  | 7314150448180 | 1 | 176 |
| SBK7801Z-1.5/16 | 7314150448173 | 1 | 176 |
| SBK7801Z-1.7/16 | 7314150448197 | 1 | 176 |
| SBK7801Z-1/2    | 7314150448067 | 1 | 176 |
| SBK7801Z-11/16  | 7314150448098 | 1 | 176 |
| SBK7801Z-13/16  | 7314150448111 | 1 | 176 |
| SBK7801Z-15/16  | 7314150448135 | 1 | 176 |
| SBK7801Z-3/4    | 7314150448104 | 1 | 176 |





# SBK7801Z-3/8



|                 |               |    |     |
|-----------------|---------------|----|-----|
| SBK7801Z-3/8    | 7314150448043 | 1  | 176 |
| SBK7801Z-5/8    | 7314150448081 | 1  | 176 |
| SBK7801Z-7/16   | 7314150448050 | 1  | 176 |
| SBK7801Z-7/8    | 7314150448128 | 1  | 176 |
| SBK7801Z-9/16   | 7314150448074 | 1  | 176 |
| SBK7806M-10     | 7314150447831 | 1  | 176 |
| SBK7806M-11     | 7314150447862 | 1  | 176 |
| SBK7806M-12     | 7314150447879 | 1  | 176 |
| SBK7806M-13     | 7314150447886 | 1  | 176 |
| SBK7806M-14     | 7314150447893 | 1  | 176 |
| SBK7806M-15     | 7314150447909 | 1  | 176 |
| SBK7806M-16     | 7314150447916 | 1  | 176 |
| SBK7806M-17     | 7314150447923 | 1  | 176 |
| SBK7806M-18     | 7314150447930 | 1  | 176 |
| SBK7806M-19     | 7314150447947 | 1  | 176 |
| SBK7806M-21     | 7314150447954 | 1  | 176 |
| SBK7806M-22     | 7314150447961 | 1  | 176 |
| SBK7806M-23     | 7314150447978 | 1  | 176 |
| SBK7806M-24     | 7314150447985 | 1  | 176 |
| SBK7806M-27     | 7314150447992 | 1  | 176 |
| SBK7806M-30     | 7314150448005 | 1  | 176 |
| SBK7806M-32     | 7314150448012 | 1  | 176 |
| SBK7806M-36     | 7314150448029 | 1  | 176 |
| SBK7806Z-1      | 7314150448401 | 1  | 177 |
| SBK7806Z-1.1/16 | 7314150448418 | 1  | 177 |
| SBK7806Z-1.1/2  | 7314150448470 | 1  | 177 |
| SBK7806Z-1.1/4  | 7314150448432 | 1  | 177 |
| SBK7806Z-1.1/8  | 7314150448425 | 5  | 177 |
| SBK7806Z-1.3/8  | 7314150448456 | 5  | 177 |
| SBK7806Z-1.5/16 | 7314150448449 | 1  | 177 |
| SBK7806Z-1.7/16 | 7314150448463 | 5  | 177 |
| SBK7806Z-1/2    | 7314150448326 | 10 | 176 |
| SBK7806Z-11/16  | 7314150448357 | 1  | 176 |
| SBK7806Z-13/16  | 7314150448371 | 1  | 176 |
| SBK7806Z-15/16  | 7314150448395 | 1  | 176 |
| SBK7806Z-3/4    | 7314150448364 | 1  | 176 |
| SBK7806Z-3/8    | 7314150448302 | 10 | 176 |
| SBK7806Z-5/8    | 7314150448340 | 5  | 176 |
| SBK7806Z-7/16   | 7314150448319 | 10 | 176 |
| SBK7806Z-7/8    | 7314150448388 | 1  | 176 |
| SBK7806Z-9/16   | 7314150448333 | 10 | 176 |
| SBK8160D-1      | 7314150447770 | 1  | 177 |
| SBK8160D-2      | 7314150447787 | 1  | 177 |
| SBK8160D-3      | 7314150447794 | 1  | 177 |
| SBK8901M-17     | 7314150448487 | 1  | 179 |
| SBK8901M-18     | 7314150448494 | 1  | 179 |
| SBK8901M-19     | 7314150448500 | 1  | 179 |
| SBK8901M-21     | 7314150448517 | 1  | 179 |
| SBK8901M-22     | 7314150448524 | 1  | 179 |
| SBK8901M-23     | 7314150448531 | 1  | 179 |
| SBK8901M-24     | 7314150448548 | 1  | 179 |
| SBK8901M-27     | 7314150448555 | 1  | 179 |
| SBK8901M-28     | 7314150448562 | 1  | 179 |
| SBK8901M-29     | 7314150448579 | 1  | 179 |
| SBK8901M-30     | 7314150448586 | 1  | 179 |
| SBK8901M-32     | 7314150448593 | 1  | 179 |
| SBK8901M-33     | 7314150448609 | 1  | 179 |
| SBK8901M-34     | 7314150448616 | 1  | 179 |
| SBK8901M-36     | 7314150448623 | 1  | 179 |
| SBK8901M-38     | 7314150448630 | 1  | 179 |
| SBK8901M-41     | 7314150448647 | 1  | 179 |
| SBK8901M-46     | 7314150448654 | 1  | 179 |
| SBK8901M-50     | 7314150448661 | 1  | 179 |
| SBK8901M-55     | 7314150448678 | 1  | 179 |
| SBK8901M-60     | 7314150448685 | 1  | 179 |
| SBK8964D        | 7314150447817 | 1  | 177 |
| SBS19-TH10      | 7314150190072 | 1  | 90  |
| SBS19-TH11      | 7314150190089 | 1  | 90  |
| SBS19-TH12      | 7314150190096 | 1  | 90  |
| SBS19-TH13      | 7314150190102 | 1  | 90  |
| SBS19-TH14      | 7314150190119 | 1  | 90  |
| SBS19-TH15      | 7314150190126 | 1  | 90  |
| SBS19-TH16      | 7314150190133 | 1  | 90  |
| SBS19-TH17      | 7314150190140 | 1  | 90  |
| SBS19-TH18      | 7314150190157 | 1  | 90  |
| SBS19-TH19      | 7314150190164 | 1  | 90  |
| SBS19-TH21      | 7314150190256 | 1  | 90  |
| SBS19-TH22      | 7314150190188 | 1  | 90  |
| SBS19-TH24      | 7314150190195 | 1  | 90  |
| SBS19-TH75      | 7314150190201 | 1  | 90  |
| SBS20-12        | 7314153009166 | 1  | 41  |
| SBS20-15        | 7314153009197 | 1  | 41  |
| SBS20-16        | 7314153009203 | 1  | 41  |
| SBS20-20        | 7314153009241 | 1  | 41  |
| SBS20-9         | 7314153009135 | 1  | 41  |
| SBS61           | 7314153009661 | 1  | 84  |
| SBS61S          | 7314150179886 | 1  | 84  |
| SBS750          | 7314153012883 | 10 | 89  |
| SBS81           | 7314153009937 | 5  | 97  |



|                 |               |     |     |
|-----------------|---------------|-----|-----|
| SBSL25          | 7314153015853 | 5   | 63  |
| SC127           | 7314150121984 | 10  | 579 |
| SC127S          | 7314150121991 | 10  | 579 |
| SC127V          | 7314150121847 | 5   | 502 |
| SC140           | 7314150122004 | 10  | 579 |
| SC140C          | 7314150122011 | 10  | 579 |
| SC150NG         | 7314150122028 | 10  | 579 |
| SC150NGV        | 7314150121854 | 5   | 502 |
| SC2RM-13-17     | 7314150265350 | 10  | 102 |
| SC2RM-15-17     | 7314150265367 | 10  | 102 |
| SC2RM-19-22     | 7314150181384 | 10  | 102 |
| SC2RM-27-30     | 7314150265343 | 1   | 102 |
| SC335M-17       | 7314150344314 | 1   | 52  |
| SC335M-19       | 7314150344321 | 1   | 52  |
| SC335M-22       | 7314150344338 | 1   | 52  |
| SC335M-24       | 7314150344345 | 1   | 52  |
| SC335M-27       | 7314150344352 | 1   | 52  |
| SC335M-30       | 7314150344369 | 1   | 52  |
| SC335M-32       | 7314150344376 | 1   | 52  |
| SC335M-36       | 7314150344383 | 1   | 52  |
| SC335M-41       | 7314150344390 | 1   | 52  |
| SC335M-46       | 7314150344406 | 1   | 52  |
| SCB140          | 7314150297351 | 10  | 579 |
| SCB140G         | 7314150297368 | 10  | 579 |
| SCRAPER-SET2    | 7311518228613 | 1   | 548 |
| SE-15-24        | 7311518029838 | 5   | 633 |
| SE-15-30        | 7311518029821 | 5   | 633 |
| SE-15-30-23     | 7311518029845 | 5   | 633 |
| SE-15-32        | 7311518249168 | 5   | 633 |
| SE-15-36        | 7311518141202 | 5   | 633 |
| SE-15-36-23     | 7311518258276 | 5   | 633 |
| SE-16-21        | 7311518029807 | 5   | 633 |
| SE-16-21-23     | 7311518273934 | 5   | 633 |
| SH-407          | 7314150389827 | 1   | 596 |
| SH-427-700      | 7314150349074 | 10  | 596 |
| SH-428-700      | 7314150349081 | 10  | 596 |
| SH-485W         | 7314150358021 | 1   | 594 |
| SH-485W-PLATES  | 7314150358038 | 1   | 594 |
| SH-486-493-495  | 7314150349098 | 10  | 596 |
| SH-486F493F495F | 7314150349104 | 10  | 596 |
| SH-486W         | 7314150358014 | 1   | 596 |
| SH-488-2000     | 7314150346912 | 10  | 596 |
| SH-488-34       | 7314150349036 | 10  | 596 |
| SH-488-56       | 7314150349043 | 10  | 596 |
| SH-488F-2000    | 7314150346950 | 10  | 596 |
| SH-488F-34      | 7314150349050 | 1   | 596 |
| SH-488F-56      | 7314150349067 | 1   | 596 |
| SH-491-34       | 7314150374298 | 12  | 596 |
| SH-491-56       | 7314150374304 | 12  | 596 |
| SH-FCP-860      | 7311518324421 | 1   | 601 |
| SH-FCS-810      | 7311518140540 | 1   | 601 |
| SH-FCS-860      | 7311518140557 | 1   | 601 |
| SH-FGS-1.8-810  | 7311518327828 | 1   | 601 |
| SH-FGS-600      | 7311518140649 | 1   | 601 |
| SH-FGS-700      | 7311518140656 | 12  | 601 |
| SH-FGS-800      | 7311518140663 | 1   | 601 |
| SH-HFGPS-400FG  | 7311518282301 | 1   | 601 |
| SH-HGPS-360     | 7311518140618 | 12  | 601 |
| SH-HGPS-380     | 7311518140625 | 1   | 601 |
| SH-HGPS-400     | 7311518207618 | 1   | 601 |
| SH-HUS-380      | 7311518140502 | 1   | 601 |
| SH-HUS-500      | 7311518140519 | 1   | 601 |
| SH-HUS-650      | 7311518140526 | 1   | 601 |
| SH-MCS-800      | 7311518140595 | 1   | 601 |
| SH-MES-900      | 7311518140601 | 12  | 601 |
| SH-MES-900FG    | 7311518282318 | 12  | 601 |
| SH-MES-F-900    | 7311518141554 | 12  | 601 |
| SH-PAGS-900     | 7311518327866 | 1   | 601 |
| SH-PAGS-900FG   | 7311518326944 | 1   | 601 |
| SH-SUS-800      | 7311518140809 | 12  | 601 |
| SHARP-INS       | 7314150197897 | 100 | 566 |
| SHARP-X         | 7311518264895 | 10  | 636 |
| SHARP-X-DISP    | 7311518264901 | 1   | 636 |
| SL24            | 7314150128389 | 1   | 64  |
| SL25            | 7314153013422 | 20  | 63  |
| SL25AF          | 7314150180141 | 20  | 64  |
| SL25L           | 7314150256570 | 10  | 64  |
| SL34            | 7314150409181 | 6   | 70  |
| SL65            | 7314150444137 | 6   | 64  |
| SLX 17          | 7314153015785 | 1   | 76  |
| SLX 17AF        | 7314150137558 | 1   | 76  |
| SLX17-CASE      | 7314150321254 | 1   | 102 |
| SP120           | 7314150312474 | 1   | 95  |
| SP120XL         | 7314150313594 | 1   | 95  |
| SPAR-CASE-A4    | 7314150263523 | 1   | 102 |
| SPAR-CASE-A6    | 7314150263547 | 1   | 102 |
| SPAR-CASE-A7    | 7314150263554 | 1   | 102 |
| SQZ-MINI        | 7314150186280 | 24  | 582 |
| SQZ-MINI-BLADE  | 7314150190348 | 1   | 582 |



|                |               |    |     |
|----------------|---------------|----|-----|
| SQZ150003      | 7314153013477 | 6  | 580 |
| SQZ150003-HSBL | 7314153015389 | 6  | 581 |
| SR1000-E       | 7314150302918 | 20 | 544 |
| SR1000-MM      | 7314150302857 | 20 | 543 |
| SR150-E        | 7314150302864 | 12 | 544 |
| SR150-MM       | 7314150302819 | 12 | 543 |
| SR200-E        | 7314150302871 | 12 | 544 |
| SR200-MM       | 7314150302826 | 12 | 543 |
| SR300-E        | 7314150302888 | 12 | 544 |
| SR300-MM       | 7314150302833 | 12 | 543 |
| SR600-E        | 7314150302901 | 20 | 544 |
| SR600-MM       | 7314150302840 | 20 | 543 |
| SS001-100      | 7314150404384 | 1  | 526 |
| SS001-150      | 7314150404377 | 1  | 526 |
| SS001-200      | 7314150404391 | 1  | 526 |
| SS001-250      | 7314150404407 | 1  | 526 |
| SS001-300      | 7314150404414 | 1  | 526 |
| SS001-375      | 7314150404421 | 1  | 526 |
| SS001-450      | 7314150404438 | 1  | 526 |
| SS001-600      | 7314150404445 | 1  | 526 |
| SS002-10       | 7314150404483 | 1  | 526 |
| SS002-11       | 7314150404490 | 1  | 526 |
| SS002-12       | 7314150404506 | 1  | 526 |
| SS002-13       | 7314150404513 | 1  | 526 |
| SS002-14       | 7314150404520 | 1  | 526 |
| SS002-15       | 7314150404537 | 1  | 526 |
| SS002-16       | 7314150404551 | 1  | 526 |
| SS002-17       | 7314150404568 | 1  | 526 |
| SS002-19       | 7314150404575 | 1  | 526 |
| SS002-21       | 7314150404582 | 1  | 526 |
| SS002-22       | 7314150404599 | 1  | 526 |
| SS002-24       | 7314150404605 | 1  | 526 |
| SS002-27       | 7314150404612 | 1  | 526 |
| SS002-32       | 7314150404629 | 1  | 526 |
| SS002-6        | 7314150404469 | 1  | 526 |
| SS002-6-2      | 7314150407903 | 1  | 526 |
| SS002-7        | 7314150445790 | 1  | 526 |
| SS002-8        | 7314150404476 | 1  | 526 |
| SS002-9-2      | 7314150407910 | 1  | 526 |
| SS003-10       | 7314150404643 | 1  | 526 |
| SS003-11       | 7314150404650 | 1  | 526 |
| SS003-12       | 7314150404667 | 1  | 526 |
| SS003-14       | 7314150404681 | 1  | 526 |
| SS003-16       | 7314150404704 | 1  | 526 |
| SS003-18       | 7314150404711 | 1  | 526 |
| SS003-20       | 7314150404728 | 1  | 526 |
| SS003-22       | 7314150404735 | 1  | 526 |
| SS003-24       | 7314150404742 | 1  | 526 |
| SS003-25       | 7314150404759 | 1  | 526 |
| SS003-26       | 7314150404766 | 1  | 526 |
| SS003-28       | 7314150404773 | 1  | 526 |
| SS003-30       | 7314150404780 | 1  | 526 |
| SS003-8        | 7314150404636 | 1  | 526 |
| SS011-0507     | 7314150404797 | 1  | 526 |
| SS011-0607     | 7314150404803 | 1  | 526 |
| SS011-0809     | 7314150404810 | 1  | 526 |
| SS011-0810     | 7314150404827 | 1  | 526 |
| SS011-0911     | 7314150404834 | 1  | 526 |
| SS011-1012     | 7314150404858 | 1  | 526 |
| SS011-11-3     | 7314150419142 | 1  | 527 |
| SS011-1214     | 7314150404865 | 1  | 526 |
| SS011-1417     | 7314150404872 | 1  | 526 |
| SS011-1618     | 7314150404889 | 1  | 526 |
| SS011-1719     | 7314150404896 | 1  | 526 |
| SS011-1722     | 7314150404902 | 1  | 526 |
| SS011-2224     | 7314150404919 | 1  | 526 |
| SS011-2427     | 7314150404926 | 1  | 526 |
| SS011-2430     | 7314150404940 | 1  | 526 |
| SS011-3032     | 7314150404957 | 1  | 526 |
| SS011-9-3      | 7314150419135 | 1  | 526 |
| SS210-10       | 7314150405343 | 1  | 527 |
| SS210-11       | 7314150405350 | 1  | 527 |
| SS210-12       | 7314150405367 | 1  | 527 |
| SS210-13       | 7314150405374 | 1  | 527 |
| SS210-14       | 7314150405381 | 1  | 527 |
| SS210-4        | 7314150405268 | 1  | 527 |
| SS210-4.5      | 7314150405275 | 1  | 527 |
| SS210-5        | 7314150405282 | 1  | 527 |
| SS210-5.5      | 7314150405299 | 1  | 527 |
| SS210-6        | 7314150405305 | 1  | 527 |
| SS210-7        | 7314150405312 | 1  | 527 |
| SS210-8        | 7314150405329 | 1  | 527 |
| SS210-9        | 7314150405336 | 1  | 527 |
| SS220-10       | 7314150404995 | 1  | 527 |
| SS220-11       | 7314150405008 | 1  | 527 |
| SS220-12       | 7314150405022 | 1  | 527 |
| SS220-13       | 7314150405039 | 1  | 527 |
| SS220-14       | 7314150405053 | 1  | 527 |
| SS220-15       | 7314150405060 | 1  | 527 |



|               |               |   |     |
|---------------|---------------|---|-----|
| SS220-16      | 7314150405077 | 1 | 527 |
| SS220-17      | 7314150405084 | 1 | 527 |
| SS220-18      | 7314150405091 | 1 | 527 |
| SS220-19      | 7314150405114 | 1 | 527 |
| SS220-20      | 7314150405121 | 1 | 527 |
| SS220-21      | 7314150405138 | 1 | 527 |
| SS220-22      | 7314150405145 | 1 | 527 |
| SS220-23      | 7314150405152 | 1 | 527 |
| SS220-24      | 7314150405176 | 1 | 527 |
| SS220-25      | 7314150405183 | 1 | 527 |
| SS220-26      | 7314150405190 | 1 | 527 |
| SS220-27      | 7314150405206 | 1 | 527 |
| SS220-28      | 7314150405213 | 1 | 527 |
| SS220-29      | 7314150405220 | 1 | 527 |
| SS220-30      | 7314150405237 | 1 | 527 |
| SS220-31      | 7314150405244 | 1 | 527 |
| SS220-32      | 7314150405251 | 1 | 527 |
| SS220-8       | 7314150404964 | 1 | 527 |
| SS220-9       | 7314150404988 | 1 | 527 |
| SS224-17      | 7314150405398 | 1 | 527 |
| SS224-19      | 7314150405404 | 1 | 527 |
| SS224-22      | 7314150405411 | 1 | 527 |
| SS224-24      | 7314150405428 | 1 | 527 |
| SS224-27      | 7314150405435 | 1 | 527 |
| SS224-30      | 7314150405442 | 1 | 527 |
| SS224-32      | 7314150405459 | 1 | 527 |
| SS224-34      | 7314150405466 | 1 | 527 |
| SS224-36      | 7314150405473 | 1 | 527 |
| SS224-41      | 7314150405480 | 1 | 527 |
| SS224-46      | 7314150405497 | 1 | 527 |
| SS224-50      | 7314150405503 | 1 | 527 |
| SS224-55      | 7314150405510 | 1 | 527 |
| SS224-60      | 7314150405527 | 1 | 527 |
| SS224-65      | 7314150405534 | 1 | 527 |
| SS234-16-100  | 7314150405572 | 1 | 527 |
| SS234-16-200  | 7314150405589 | 1 | 527 |
| SS234-16-250  | 7314150405602 | 1 | 527 |
| SS234-24-100  | 7314150405619 | 1 | 527 |
| SS234-24-200  | 7314150405626 | 1 | 527 |
| SS234-24-250  | 7314150405633 | 1 | 527 |
| SS236-08-80   | 7314150405718 | 1 | 527 |
| SS236-16-80   | 7314150405701 | 1 | 527 |
| SS236-24-110  | 7314150405725 | 1 | 527 |
| SS238-08-250  | 7314150405657 | 1 | 527 |
| SS238-16-250  | 7314150405640 | 1 | 527 |
| SS238-24-350  | 7314150405664 | 1 | 527 |
| SS242-08-200  | 7314150405558 | 1 | 528 |
| SS242-16-245  | 7314150405541 | 1 | 528 |
| SS242-24-320  | 7314150405565 | 1 | 528 |
| SS243-08      | 7314150405688 | 1 | 527 |
| SS243-16      | 7314150405671 | 1 | 527 |
| SS243-24      | 7314150405695 | 1 | 527 |
| SS324-1.5     | 7314150405732 | 2 | 528 |
| SS324-10      | 7314150405824 | 1 | 528 |
| SS324-2       | 7314150405749 | 2 | 528 |
| SS324-2.5     | 7314150405756 | 2 | 528 |
| SS324-3       | 7314150405763 | 1 | 528 |
| SS324-4       | 7314150405770 | 1 | 528 |
| SS324-5       | 7314150405787 | 1 | 528 |
| SS324-6       | 7314150405794 | 1 | 528 |
| SS324-8       | 7314150405817 | 1 | 528 |
| SS325-10      | 7314150405886 | 1 | 529 |
| SS325-12      | 7314150405879 | 1 | 529 |
| SS325-2.5     | 7314150405909 | 2 | 529 |
| SS325-3       | 7314150405862 | 2 | 529 |
| SS325-3.5     | 7314150405923 | 2 | 529 |
| SS325-4       | 7314150405848 | 1 | 529 |
| SS325-4.5     | 7314150405930 | 1 | 529 |
| SS325-5       | 7314150405893 | 1 | 529 |
| SS325-6       | 7314150405855 | 1 | 529 |
| SS325-7       | 7314150405916 | 1 | 529 |
| SS325-8       | 7314150405831 | 1 | 529 |
| SS400-160     | 7314150405978 | 1 | 529 |
| SS400-180     | 7314150405985 | 1 | 529 |
| SS400-200     | 7314150405992 | 1 | 529 |
| SS402-160     | 7314150406005 | 1 | 530 |
| SS402-200     | 7314150406012 | 1 | 530 |
| SS406-160     | 7314150406029 | 1 | 530 |
| SS406-200     | 7314150406036 | 1 | 530 |
| SS410-250     | 7314150406043 | 1 | 530 |
| SS410-300     | 7314150406050 | 1 | 530 |
| SS412-200     | 7314150406067 | 1 | 530 |
| SS415-225     | 7314150406074 | 1 | 530 |
| SS502-1000-FB | 7314150406081 | 1 | 530 |
| SS502-1500-FB | 7314150406098 | 1 | 530 |
| SS502-2000-FB | 7314150406104 | 1 | 530 |
| SS502-2500-FB | 7314150406111 | 1 | 530 |
| SS502-3000-FB | 7314150406128 | 1 | 530 |
| SS502-3600-FB | 7314150406135 | 1 | 530 |





# SS506-1100-FB



|                 |               |   |     |
|-----------------|---------------|---|-----|
| SS506-1100-FB   | 7314150406197 | 1 | 530 |
| SS506-200-FB    | 7314150406142 | 1 | 530 |
| SS506-300-FB    | 7314150406159 | 1 | 530 |
| SS506-500-FB    | 7314150406166 | 1 | 530 |
| SS506-700-FB    | 7314150406173 | 1 | 530 |
| SS506-900-FB    | 7314150406180 | 1 | 530 |
| SS603-15-500    | 7314150406203 | 1 | 530 |
| SS603-19-500    | 7314150406210 | 1 | 530 |
| SS603-20-500    | 7314150406227 | 1 | 530 |
| SS603-23-500    | 7314150406234 | 1 | 530 |
| SS603-23-800    | 7314150406258 | 1 | 530 |
| SS603-25-600    | 7314150406241 | 1 | 530 |
| SS603-30-1000   | 7314150406265 | 1 | 530 |
| SS610-16-160    | 7314150406272 | 1 | 530 |
| SS610-18-200    | 7314150406289 | 1 | 530 |
| SS610-24-300    | 7314150406296 | 1 | 530 |
| SS610-25-400    | 7314150406302 | 1 | 530 |
| SS610-30-500    | 7314150406319 | 1 | 530 |
| SUP-20-LAM      | 7311518258351 | 4 | 563 |
| SUS-2.0-800     | 7311518123451 | 4 | 600 |
| SW65            | 7314150442898 | 6 | 64  |
| SW79            | 7314150442904 | 4 | 63  |
| SW91            | 7314150442942 | 4 | 63  |
| TAH08-10        | 7314150305087 | 1 | 477 |
| TAH08-11        | 7314150305094 | 1 | 477 |
| TAH08-12        | 7314150305100 | 1 | 477 |
| TAH08-13        | 7314150305117 | 1 | 477 |
| TAH08-5.5       | 7314150305032 | 1 | 477 |
| TAH08-6         | 7314150305049 | 1 | 477 |
| TAH08-7         | 7314150305056 | 1 | 477 |
| TAH08-8         | 7314150305063 | 1 | 477 |
| TAH08-9         | 7314150305070 | 1 | 477 |
| TAH08-H3        | 7314150305124 | 1 | 477 |
| TAH08-H4        | 7314150305131 | 1 | 477 |
| TAH08-H5        | 7314150305148 | 1 | 477 |
| TAH08-H6        | 7314150305155 | 1 | 477 |
| TAH08-H8        | 7314150305162 | 1 | 477 |
| TAH08-PH1       | 7314150305179 | 1 | 477 |
| TAH08-PH2       | 7314150305186 | 1 | 477 |
| TAH08-PH3       | 7314150305193 | 1 | 477 |
| TAH08-T10       | 7314150305223 | 1 | 478 |
| TAH08-T15       | 7314150305230 | 1 | 478 |
| TAH08-T20       | 7314150305247 | 1 | 478 |
| TAH08-T25       | 7314150305254 | 1 | 478 |
| TAH08-T27       | 7314150305261 | 1 | 478 |
| TAH08-T30       | 7314150305278 | 1 | 478 |
| TAH08-T40       | 7314150305285 | 1 | 478 |
| TAH08-T8        | 7314150305209 | 1 | 478 |
| TAH08-T9        | 7314150305216 | 1 | 478 |
| TAH1-100-06-2-4 | 7314150307531 | 1 | 485 |
| TAH1-110-08-1-2 | 7314150437825 | 1 | 485 |
| TAH1-143-12-1-2 | 7314150307548 | 1 | 485 |
| TAH1-160-08-1-2 | 7314150437818 | 1 | 485 |
| TAH1-170-08-1-2 | 7314150437801 | 1 | 485 |
| TAH1-210-06-2-2 | 7314150307555 | 1 | 485 |
| TAH1-210-08-1-2 | 7314150437795 | 1 | 485 |
| TAH1-230-06-2-2 | 7314150307562 | 1 | 485 |
| TAH1-230-08-1-2 | 7314150437788 | 1 | 485 |
| TAH111M-10      | 7314150308538 | 1 | 475 |
| TAH111M-11      | 7314150308545 | 1 | 475 |
| TAH111M-12      | 7314150308552 | 1 | 475 |
| TAH111M-13      | 7314150308569 | 1 | 475 |
| TAH111M-14      | 7314150308576 | 1 | 475 |
| TAH111M-15      | 7314150308583 | 1 | 475 |
| TAH111M-16      | 7314150308590 | 1 | 475 |
| TAH111M-17      | 7314150308606 | 1 | 475 |
| TAH111M-18      | 7314150308613 | 1 | 475 |
| TAH111M-19      | 7314150308620 | 1 | 475 |
| TAH111M-20      | 7314150308637 | 1 | 475 |
| TAH111M-21      | 7314150308644 | 1 | 475 |
| TAH111M-22      | 7314150308651 | 1 | 475 |
| TAH111M-23      | 7314150308668 | 1 | 475 |
| TAH111M-24      | 7314150308675 | 1 | 475 |
| TAH111M-25      | 7314150308682 | 1 | 475 |
| TAH111M-27      | 7314150308689 | 1 | 475 |
| TAH111M-30      | 7314150308699 | 1 | 475 |
| TAH111M-32      | 7314150308705 | 1 | 475 |
| TAH111M-34      | 7314150308712 | 1 | 475 |
| TAH111M-36      | 7314150308729 | 1 | 475 |
| TAH111M-41      | 7314150308736 | 1 | 475 |
| TAH111M-46      | 7314150308743 | 1 | 475 |
| TAH111M-50      | 7314150308750 | 1 | 475 |
| TAH111M-55      | 7314150411573 | 1 | 475 |
| TAH111M-6       | 7314150308491 | 1 | 475 |
| TAH111M-7       | 7314150308507 | 1 | 475 |
| TAH111M-8       | 7314150308514 | 1 | 475 |
| TAH111M-9       | 7314150308521 | 1 | 475 |
| TAH111Z-1       | 7314150343362 | 1 | 475 |
| TAH111Z-1.1/16  | 7314150343379 | 1 | 475 |



|                 |               |   |     |
|-----------------|---------------|---|-----|
| TAH111Z-1.1/2   | 7314150431830 | 1 | 475 |
| TAH111Z-1.1/4   | 7314150343386 | 1 | 475 |
| TAH111Z-1.1/8   | 7314150343393 | 1 | 475 |
| TAH111Z-1.11/16 | 7314150431854 | 1 | 475 |
| TAH111Z-1.13/16 | 7314150431878 | 1 | 475 |
| TAH111Z-1.3/4   | 7314150431861 | 1 | 475 |
| TAH111Z-1.3/8   | 7314150431816 | 1 | 475 |
| TAH111Z-1.5/16  | 7314150343409 | 1 | 475 |
| TAH111Z-1.5/8   | 7314150431847 | 1 | 475 |
| TAH111Z-1.7/16  | 7314150431823 | 1 | 475 |
| TAH111Z-1.7/8   | 7314150431885 | 1 | 475 |
| TAH111Z-1/2     | 7314150343461 | 1 | 475 |
| TAH111Z-1/4     | 7314150343508 | 1 | 475 |
| TAH111Z-11/16   | 7314150343522 | 1 | 475 |
| TAH111Z-13/16   | 7314150343539 | 1 | 475 |
| TAH111Z-15/16   | 7314150343546 | 1 | 475 |
| TAH111Z-2       | 7314150431892 | 1 | 475 |
| TAH111Z-2.1/4   | 7314150431915 | 1 | 475 |
| TAH111Z-2.3/4   | 7314150431946 | 1 | 475 |
| TAH111Z-2.3/8   | 7314150413959 | 1 | 475 |
| TAH111Z-2.5/8   | 7314150431939 | 1 | 475 |
| TAH111Z-2.7/8   | 7314150431953 | 1 | 475 |
| TAH111Z-3       | 7314150431960 | 1 | 475 |
| TAH111Z-3/4     | 7314150343553 | 1 | 475 |
| TAH111Z-3/8     | 7314150343560 | 1 | 475 |
| TAH111Z-5/16    | 7314150343591 | 1 | 475 |
| TAH111Z-5/8     | 7314150343607 | 1 | 475 |
| TAH111Z-7/16    | 7314150343614 | 1 | 475 |
| TAH111Z-7/8     | 7314150343621 | 1 | 475 |
| TAH111Z-9/16    | 7314150343638 | 1 | 475 |
| TAH1150-1/2H/P  | 7314150307760 | 1 | 488 |
| TAH1177-SCRIBE  | 7314150307777 | 1 | 488 |
| TAH140          | 7314150344475 | 1 | 477 |
| TAH141          | 7314150339433 | 1 | 477 |
| TAH1410         | 7314150344543 | 1 | 477 |
| TAH142          | 7314150339440 | 1 | 477 |
| TAH1420         | 7314150344550 | 1 | 477 |
| TAH143          | 7314150344482 | 1 | 477 |
| TAH1544         | 7314150307746 | 1 | 489 |
| TAH16-H10       | 7314150306176 | 1 | 479 |
| TAH16-H12       | 7314150306183 | 1 | 479 |
| TAH16-H14       | 7314150306190 | 1 | 479 |
| TAH16-H17       | 7314150306206 | 1 | 479 |
| TAH16-H19       | 7314150306213 | 1 | 479 |
| TAH16-H4        | 7314150306121 | 1 | 479 |
| TAH16-H5        | 7314150306138 | 1 | 479 |
| TAH16-H6        | 7314150306145 | 1 | 479 |
| TAH16-H7        | 7314150306152 | 1 | 479 |
| TAH16-H8        | 7314150306169 | 1 | 479 |
| TAH16-T30       | 7314150306220 | 1 | 479 |
| TAH16-T40       | 7314150306237 | 1 | 479 |
| TAH16-T45       | 7314150306244 | 1 | 479 |
| TAH16-T50       | 7314150306251 | 1 | 479 |
| TAH16-T55       | 7314150306268 | 1 | 479 |
| TAH16-T60       | 7314150306275 | 1 | 479 |
| TAH16B-1        | 7314150306077 | 1 | 478 |
| TAH16B-1.1/16   | 7314150306084 | 1 | 478 |
| TAH16B-1.1/4    | 7314150306107 | 1 | 478 |
| TAH16B-1.1/8    | 7314150306114 | 1 | 478 |
| TAH16B-1/2      | 7314150305995 | 1 | 478 |
| TAH16B-10       | 7314150305629 | 1 | 478 |
| TAH16B-11       | 7314150305636 | 1 | 478 |
| TAH16B-11/16    | 7314150306022 | 1 | 478 |
| TAH16B-12       | 7314150305643 | 1 | 478 |
| TAH16B-13       | 7314150305650 | 1 | 478 |
| TAH16B-13/16    | 7314150306046 | 1 | 478 |
| TAH16B-14       | 7314150305667 | 1 | 478 |
| TAH16B-15       | 7314150305674 | 1 | 478 |
| TAH16B-15/16    | 7314150306060 | 1 | 478 |
| TAH16B-16       | 7314150305698 | 1 | 478 |
| TAH16B-17       | 7314150305704 | 1 | 478 |
| TAH16B-18       | 7314150305711 | 1 | 478 |
| TAH16B-19       | 7314150305728 | 1 | 478 |
| TAH16B-21       | 7314150305735 | 1 | 478 |
| TAH16B-22       | 7314150305742 | 1 | 478 |
| TAH16B-24       | 7314150305759 | 1 | 478 |
| TAH16B-25       | 7314150305766 | 1 | 478 |
| TAH16B-27       | 7314150305773 | 1 | 478 |
| TAH16B-3/4      | 7314150306039 | 1 | 478 |
| TAH16B-30       | 7314150305780 | 1 | 478 |
| TAH16B-32       | 7314150305797 | 1 | 478 |
| TAH16B-5/8      | 7314150306015 | 1 | 478 |
| TAH16B-7/8      | 7314150306053 | 1 | 478 |
| TAH16B-8        | 7314150305612 | 1 | 478 |
| TAH16B-9/16     | 7314150306008 | 1 | 478 |
| TAH16BM/22      | 7314150422357 | 1 | 479 |
| TAH16BZ/17      | 7314150422340 | 1 | 479 |
| TAH16H-1/2      | 7314150306329 | 1 | 479 |
| TAH16H-1/4      | 7314150306282 | 1 | 479 |

| Model          | Part Number   | Quantity | Weight |
|----------------|---------------|----------|--------|
| TAH16H-3/8     | 7314150306305 | 1        | 479    |
| TAH16H-5/16    | 7314150306299 | 1        | 479    |
| TAH16H-5/8     | 7314150306343 | 1        | 479    |
| TAH16H-7/16    | 7314150306312 | 1        | 479    |
| TAH16H-9/16    | 7314150306336 | 1        | 479    |
| TAH1949M-10-11 | 7314150308866 | 1        | 476    |
| TAH1949M-12-14 | 7314150308873 | 1        | 476    |
| TAH1949M-14-17 | 7314150308880 | 1        | 476    |
| TAH1949M-19-22 | 7314150308897 | 1        | 476    |
| TAH1949M-24-27 | 7314150308903 | 1        | 476    |
| TAH1949M-8-9   | 7314150308859 | 1        | 476    |
| TAH1995M-10    | 7314150432219 | 1        | 482    |
| TAH1995M-12    | 7314150432226 | 1        | 482    |
| TAH1995M-8     | 7314150432202 | 1        | 482    |
| TAH1995Z-1/2   | 7314150415007 | 1        | 482    |
| TAH1RM-10      | 7314150414338 | 1        | 475    |
| TAH1RM-11      | 7314150424306 | 1        | 475    |
| TAH1RM-12      | 7314150424313 | 1        | 475    |
| TAH1RM-13      | 7314150414345 | 1        | 475    |
| TAH1RM-14      | 7314150424320 | 1        | 475    |
| TAH1RM-15      | 7314150424337 | 1        | 475    |
| TAH1RM-16      | 7314150414352 | 1        | 475    |
| TAH1RM-17      | 7314150352210 | 1        | 475    |
| TAH1RM-18      | 7314150414369 | 1        | 475    |
| TAH1RM-19      | 7314150352227 | 1        | 475    |
| TAH1RM-21      | 7314150424344 | 1        | 475    |
| TAH1RM-22      | 7314150424351 | 1        | 475    |
| TAH1RM-24      | 7314150352234 | 1        | 475    |
| TAH1RM-27      | 7314150424368 | 1        | 475    |
| TAH1RM-30      | 7314150352241 | 1        | 475    |
| TAH1RM-32      | 7314150424375 | 1        | 475    |
| TAH1RM-6       | 7314150424269 | 1        | 475    |
| TAH1RM-7       | 7314150424276 | 1        | 475    |
| TAH1RM-8       | 7314150424283 | 1        | 475    |
| TAH1RM-9       | 7314150424290 | 1        | 475    |
| TAH2047-0.8-4  | 7314150308088 | 1        | 482    |
| TAH2047PR-1-2  | 7314150308095 | 1        | 482    |
| TAH2101G-125   | 7314150344581 | 1        | 482    |
| TAH2101G-125C  | 7314150344598 | 1        | 482    |
| TAH2101G-140   | 7314150307869 | 1        | 482    |
| TAH2101G-140C  | 7314150344611 | 1        | 482    |
| TAH2101G-160   | 7314150307876 | 1        | 482    |
| TAH2101G-160C  | 7314150344635 | 1        | 482    |
| TAH2101G-180   | 7314150345106 | 1        | 482    |
| TAH2101G-180C  | 7314150344666 | 1        | 482    |
| TAH21HDG-200   | 7314150345649 | 1        | 483    |
| TAH21HDG-200C  | 7314150345656 | 1        | 483    |
| TAH2223G-150   | 7314150411597 | 1        | 483    |
| TAH225-PLUS    | 7314150319978 | 1        | 485    |
| TAH2339-250    | 7314150536320 | 1        | 484    |
| TAH2427G-200   | 7314150307883 | 1        | 483    |
| TAH2430G-160   | 7314150413942 | 1        | 483    |
| TAH2430G-200   | 7314150307906 | 1        | 483    |
| TAH2484-30     | 7314150307968 | 1        | 487    |
| TAH2487        | 7314150320028 | 1        | 489    |
| TAH24B-27      | 7314150309306 | 1        | 479    |
| TAH24B-30      | 7314150309313 | 1        | 479    |
| TAH24B-32      | 7314150309320 | 1        | 479    |
| TAH24B-36      | 7314150309337 | 1        | 479    |
| TAH24B-38      | 7314150309344 | 1        | 479    |
| TAH24B-41      | 7314150309351 | 1        | 479    |
| TAH24B-46      | 7314150309368 | 1        | 479    |
| TAH24B-50      | 7314150309375 | 1        | 479    |
| TAH2509        | 7314150307753 | 1        | 490    |
| TAH2535F2      | 7314150307784 | 1        | 490    |
| TAH2628G-160   | 7314150307913 | 1        | 483    |
| TAH2628G-180   | 7314150307920 | 1        | 483    |
| TAH2628G-200   | 7314150432363 | 1        | 483    |
| TAH2633/S4     | 7314150415014 | 1        | 490    |
| TAH2800-150    | 7314150519330 | 1        | 483    |
| TAH2800-180    | 7314150424559 | 1        | 483    |
| TAH2820EF2     | 7314150307708 | 1        | 485    |
| TAH2855        | 7314150307937 | 1        | 484    |
| TAH2900-180    | 7314150424566 | 1        | 483    |
| TAH2951-250    | 7314150432400 | 1        | 484    |
| TAH2953-140    | 7314150415731 | 1        | 484    |
| TAH2953-300    | 7314150415748 | 1        | 484    |
| TAH2958-200    | 7314150320219 | 1        | 484    |
| TAH2958-250    | 7314150307944 | 1        | 484    |
| TAH2970G-200   | 7314150343331 | 1        | 483    |
| TAH29M-10      | 7314150414413 | 1        | 476    |
| TAH29M-11      | 7314150414420 | 1        | 476    |
| TAH29M-12      | 7314150424382 | 1        | 476    |
| TAH29M-13      | 7314150414437 | 1        | 476    |
| TAH29M-14      | 7314150424399 | 1        | 476    |
| TAH29M-15      | 7314150424405 | 1        | 476    |
| TAH29M-16      | 7314150424412 | 1        | 476    |
| TAH29M-17      | 7314150414444 | 1        | 476    |
| TAH29M-18      | 7314150424429 | 1        | 476    |

| Model           | Part Number   | Quantity | Weight |
|-----------------|---------------|----------|--------|
| TAH29M-19       | 7314150424436 | 1        | 476    |
| TAH29M-20       | 7314150424443 | 1        | 476    |
| TAH29M-21       | 7314150414451 | 1        | 476    |
| TAH29M-22       | 7314150424450 | 1        | 476    |
| TAH29M-23       | 7314150424467 | 1        | 476    |
| TAH29M-24       | 7314150424474 | 1        | 476    |
| TAH29M-25       | 7314150424481 | 1        | 476    |
| TAH29M-26       | 7314150424498 | 1        | 476    |
| TAH29M-27       | 7314150424504 | 1        | 476    |
| TAH29M-28       | 7314150424511 | 1        | 476    |
| TAH29M-29       | 7314150424528 | 1        | 476    |
| TAH29M-30       | 7314150424535 | 1        | 476    |
| TAH29M-32       | 7314150424542 | 1        | 476    |
| TAH29M-6        | 7314150414376 | 1        | 476    |
| TAH29M-7        | 7314150414383 | 1        | 476    |
| TAH29M-8        | 7314150414390 | 1        | 476    |
| TAH29M-9        | 7314150414406 | 1        | 476    |
| TAH2M-10-11     | 7314150427772 | 1        | 476    |
| TAH2M-12-13     | 7314150427789 | 1        | 476    |
| TAH2M-14-15     | 7314150427796 | 1        | 476    |
| TAH2M-16-17     | 7314150427802 | 1        | 476    |
| TAH2M-18-19     | 7314150427819 | 1        | 476    |
| TAH2M-6-7       | 7314150427758 | 1        | 476    |
| TAH2M-8-9       | 7314150427765 | 1        | 476    |
| TAH317          | 7314150319985 | 1        | 485    |
| TAH320          | 7314150319992 | 1        | 484    |
| TAH325          | 7314150320004 | 1        | 484    |
| TAH3625PU-50    | 7314150307579 | 1        | 486    |
| TAH3625W-35     | 7314150307609 | 1        | 486    |
| TAH3640-250-C   | 7314150307975 | 1        | 487    |
| TAH3681-11      | 7314150415038 | 1        | 488    |
| TAH3681-16      | 7314150415045 | 1        | 488    |
| TAH3681-20      | 7314150415052 | 1        | 488    |
| TAH3683         | 7314150352258 | 1        | 487    |
| TAH3734BM-10    | 7314150308057 | 1        | 487    |
| TAH3734BM-2     | 7314150343348 | 1        | 487    |
| TAH3734BM-3     | 7314150307982 | 1        | 487    |
| TAH3734BM-4     | 7314150308019 | 1        | 487    |
| TAH3734BM-5     | 7314150308026 | 1        | 487    |
| TAH3734BM-6     | 7314150308033 | 1        | 487    |
| TAH3734BM-8     | 7314150308040 | 1        | 487    |
| TAH3739-300     | 7314150373925 | 1        | 487    |
| TAH3755BM-4     | 7314150308064 | 1        | 487    |
| TAH380-10       | 7314150307845 | 1        | 487    |
| TAH380-14       | 7314150320172 | 1        | 477    |
| TAH380-18       | 7314150307852 | 1        | 477    |
| TAH380-24       | 7314150343317 | 1        | 477    |
| TAH396-JT       | 7314150373932 | 1        | 484    |
| TAH4205H-80-160 | 7314150411610 | 1        | 489    |
| TAH466-250      | 7314150307791 | 1        | 488    |
| TAH479-16       | 7314150307586 | 1        | 486    |
| TAH479-32       | 7314150307593 | 1        | 486    |
| TAH481-300      | 7314150307616 | 1        | 486    |
| TAH484-1000     | 7314150373918 | 1        | 486    |
| TAH484-1500     | 7314150307623 | 1        | 486    |
| TAH484-2000     | 7314150319916 | 1        | 486    |
| TAH485          | 7314150459902 | 1        | 487    |
| TAH486F-700     | 7314150370658 | 1        | 486    |
| TAH487-5200     | 7314150307630 | 1        | 487    |
| TAH489-1100     | 7314150307647 | 1        | 486    |
| TAH489-1800     | 7314150343294 | 1        | 486    |
| TAH489-2700     | 7314150319923 | 1        | 486    |
| TAH489-3600     | 7314150307654 | 1        | 486    |
| TAH489-4500     | 7314150427567 | 1        | 486    |
| TAH489-5400     | 7314150319930 | 1        | 486    |
| TAH490-1100     | 7314150427475 | 1        | 486    |
| TAH490-700      | 7314150427529 | 1        | 486    |
| TAH490-900      | 7314150427536 | 1        | 486    |
| TAH52           | 7314150339730 | 1        | 486    |
| TAH6950         | 7314150309054 | 1        | 478    |
| TAH6956-1       | 7314150309061 | 1        | 478    |
| TAH6958B-1      | 7314150309078 | 1        | 477    |
| TAH6960         | 7314150305315 | 1        | 477    |
| TAH6961         | 7314150305322 | 1        | 477    |
| TAH6962         | 7314150305339 | 1        | 477    |
| TAH6962L        | 7314150305346 | 1        | 477    |
| TAH6966         | 7314150305353 | 1        | 477    |
| TAH6M-10-11     | 7314150370665 | 1        | 476    |
| TAH6M-12-13     | 7314150370672 | 1        | 476    |
| TAH6M-14-15     | 7314150400393 | 1        | 476    |
| TAH6M-16-17     | 7314150400409 | 1        | 476    |
| TAH6M-17-19     | 7314150370689 | 1        | 476    |
| TAH6M-18-19     | 7314150400416 | 1        | 476    |
| TAH6M-20-22     | 7314150400423 | 1        | 476    |
| TAH6M-24-27     | 7314150400430 | 1        | 476    |
| TAH6M-30-32     | 7314150400447 | 1        | 476    |
| TAH6M-6-7       | 7314150427741 | 1        | 476    |
| TAH6M-8-9       | 7314150400386 | 1        | 476    |
| TAH700-1.5-50   | 7314150432301 | 1        | 481    |



# TAH700-1.8-50



|                |               |   |     |
|----------------|---------------|---|-----|
| TAH700-1.8-50  | 7314150432318 | 1 | 481 |
| TAH700-2.5-50  | 7314150432325 | 1 | 481 |
| TAH700-3-100   | 7314150432332 | 1 | 481 |
| TAH701-0-50    | 7314150432349 | 1 | 481 |
| TAH701-00-50   | 7314150432356 | 1 | 481 |
| TAH703-10-50   | 7314150432288 | 1 | 482 |
| TAH703-15-75   | 7314150432295 | 1 | 482 |
| TAH703-6-50    | 7314150432240 | 1 | 482 |
| TAH703-7-50    | 7314150432257 | 1 | 482 |
| TAH703-8-50    | 7314150432264 | 1 | 482 |
| TAH703-9-50    | 7314150432271 | 1 | 482 |
| TAH73R-100     | 7314150503810 | 1 | 489 |
| TAH73R-200     | 7314150503834 | 1 | 489 |
| TAH73R-300     | 7314150503858 | 1 | 489 |
| TAH7444SG-M-36 | 7314150308934 | 1 | 476 |
| TAH7444SG-M-41 | 7314150308941 | 1 | 476 |
| TAH7444SG-M-46 | 7314150308958 | 1 | 476 |
| TAH7444SG-M-50 | 7314150308965 | 1 | 476 |
| TAH7444SG-M-55 | 7314150308972 | 1 | 476 |
| TAH7445-100A-1 | 7314150327546 | 1 | 489 |
| TAH7452-2      | 7314150302543 | 1 | 489 |
| TAH7455-300-1  | 7314150309412 | 1 | 489 |
| TAH74W9-100    | 7314150519354 | 1 | 489 |
| TAH782-U       | 7314150339747 | 1 | 486 |
| TAH7852-1      | 7314150302550 | 1 | 489 |
| TAH8069        | 7314150383603 | 1 | 475 |
| TAH8069C       | 7314150383610 | 1 | 475 |
| TAH8070        | 7314150347025 | 1 | 475 |
| TAH8070C       | 7314150383627 | 1 | 475 |
| TAH8071        | 7314150347032 | 1 | 475 |
| TAH8071C       | 7314150383634 | 1 | 475 |
| TAH8072        | 7314150307487 | 1 | 475 |
| TAH8072C       | 7314150383641 | 1 | 475 |
| TAH8073        | 7314150319831 | 1 | 475 |
| TAH8073C       | 7314150383658 | 1 | 475 |
| TAH8074        | 7314150319848 | 1 | 475 |
| TAH8074C       | 7314150383665 | 1 | 475 |
| TAH8075        | 7314150307500 | 1 | 475 |
| TAH8075C       | 7314150383672 | 1 | 475 |
| TAH8150-1/2    | 7314150309283 | 1 | 479 |
| TAH8158B-1     | 7314150309290 | 1 | 478 |
| TAH8160        | 7314150306367 | 1 | 478 |
| TAH8162        | 7314150306374 | 1 | 478 |
| TAH8166        | 7314150306381 | 1 | 478 |
| TAH8224        | 7314150307951 | 1 | 484 |
| TAH84-PODGER   | 7314150312221 | 1 | 475 |
| TAH8950N/A     | 7314150309382 | 1 | 480 |
| TAH8953        | 7314150309399 | 1 | 479 |
| TAH8961        | 7314150309405 | 1 | 479 |
| TAH9045-B-250  | 7314150411634 | 1 | 488 |
| TAH9048-250    | 7314150411627 | 1 | 488 |
| TAH9070        | 7314150307517 | 1 | 475 |
| TAH9072        | 7314150307524 | 1 | 475 |
| TAHBE-8020L    | 7314150308101 | 1 | 480 |
| TAHBE-8030     | 7314150308118 | 1 | 480 |
| TAHBE-8040     | 7314150308125 | 1 | 480 |
| TAHBE-8040S    | 7314150308132 | 1 | 481 |
| TAHBE-8050S    | 7314150308149 | 1 | 481 |
| TAHBE-8155     | 7314150308156 | 1 | 480 |
| TAHBE-8220S    | 7314150308163 | 1 | 481 |
| TAHBE-8241     | 7314150308217 | 1 | 480 |
| TAHBE-8252     | 7314150308224 | 1 | 480 |
| TAHBE-8255S    | 7314150320226 | 1 | 481 |
| TAHBE-8257     | 7314150308231 | 1 | 480 |
| TAHBE-8258     | 7314150308248 | 1 | 480 |
| TAHBE-8260     | 7314150308255 | 1 | 480 |
| TAHBE-8350     | 7314150308262 | 1 | 480 |
| TAHBE-8602     | 7314150308279 | 1 | 480 |
| TAHBE-8610     | 7314150308286 | 1 | 480 |
| TAHBE-8610S    | 7314150308293 | 1 | 481 |
| TAHBE-8611     | 7314150308309 | 1 | 480 |
| TAHBE-8620     | 7314150308316 | 1 | 480 |
| TAHBE-8620L    | 7314150308323 | 1 | 480 |
| TAHBE-8620S    | 7314150308330 | 1 | 481 |
| TAHBE-8623     | 7314150308347 | 1 | 480 |
| TAHBE-8624     | 7314150308354 | 1 | 480 |
| TAHBE-8630     | 7314150308361 | 1 | 480 |
| TAHBE-8630S    | 7314150320233 | 1 | 481 |
| TAHBE-8640S    | 7314150320240 | 1 | 481 |
| TAHBE-8810     | 7314150308378 | 1 | 481 |
| TAHBE-8820     | 7314150308385 | 1 | 481 |
| TAHBE-8820SL   | 7314150347827 | 1 | 481 |
| TAHBE-8830     | 7314150308392 | 1 | 481 |
| TAHBE-8880     | 7314150432196 | 1 | 480 |
| TAHBE-8910     | 7314150343713 | 1 | 481 |
| TAHBE-8910S    | 7314150343799 | 1 | 481 |
| TAHBE-8915     | 7314150343744 | 1 | 481 |
| TAHBE-8915S    | 7314150343805 | 1 | 481 |
| TAHBE-8920     | 7314150343751 | 1 | 481 |



|                |               |   |     |
|----------------|---------------|---|-----|
| TAHBE-8920S    | 7314150343812 | 1 | 481 |
| TAHBE-8925     | 7314150343768 | 1 | 481 |
| TAHBE-8925S    | 7314150343829 | 1 | 481 |
| TAHBE-8930     | 7314150343775 | 1 | 481 |
| TAHBE-8930S    | 7314150343836 | 1 | 481 |
| TAHBE-9776     | 7314150432233 | 1 | 482 |
| TAHBE-9777B    | 7314150307685 | 1 | 482 |
| TAHBE-9787     | 7314150307692 | 1 | 482 |
| TAHBE64520     | 7314150307821 | 1 | 490 |
| TAHBFRL11      | 7314150307739 | 1 | 490 |
| TAHBOD5400     | 7314150339457 | 1 | 490 |
| TAHBOD5450     | 7314150339464 | 1 | 490 |
| TAHCRW01       | 7314150432370 | 1 | 483 |
| TAHCS300       | 7314150411603 | 1 | 488 |
| TAHLTS-30      | 7314150432387 | 1 | 488 |
| TAHMK5         | 7314150411580 | 1 | 476 |
| TAHPINRELEASER | 7314150307638 | 1 | 480 |
| TAHSC2RM-13-17 | 7314150339792 | 1 | 476 |
| TAHSC2RM-15-17 | 7314150339785 | 1 | 476 |
| TAHSC2RM-19-22 | 7314150339761 | 1 | 476 |
| TAHSC2RM-27-30 | 7314150339778 | 1 | 476 |
| TAHSCB140G     | 7314150308071 | 1 | 485 |
| TAHSR300-MM    | 7314150415021 | 1 | 488 |
| TAHWBB600      | 7314150440429 | 1 | 487 |
| TAHWBB700      | 7314150440436 | 1 | 487 |
| TAM12135       | 7314150215331 | 1 | 115 |
| TAM12200       | 7314150215348 | 1 | 115 |
| TAM12340       | 7314150215355 | 1 | 115 |
| TAM1430        | 7314150215317 | 1 | 115 |
| TAM38135       | 7314150215324 | 1 | 115 |
| TAS14H007      | 7314150423187 | 1 | 111 |
| TAS14H09       | 7314150423200 | 1 | 111 |
| TAS14S007      | 7314150423194 | 1 | 111 |
| TAS14S09       | 7314150423217 | 1 | 111 |
| TASM14H007     | 7314150539444 | 1 | 111 |
| TASM14H09      | 7314150539437 | 1 | 111 |
| TASMB14H007    | 7314150489664 | 1 | 111 |
| TASMB14H09     | 7314150489671 | 1 | 111 |
| TAW12340       | 7314150274963 | 1 | 105 |
| TAW1412M       | 7314150423156 | 1 | 105 |
| TAW1430M       | 7314150422289 | 1 | 105 |
| TAW14340       | 7314150340842 | 1 | 105 |
| TAW24800       | 7314150368297 | 1 | 105 |
| TAW34800       | 7314150285471 | 1 | 105 |
| TAW38135       | 7314150274956 | 1 | 105 |
| TAW38135M      | 7314150502295 | 1 | 105 |
| TAW912M        | 7314150423163 | 1 | 105 |
| TAW9135        | 7314150340859 | 1 | 105 |
| TAW9135M       | 7314150502288 | 1 | 105 |
| TAW930M        | 7314150422319 | 1 | 105 |
| TAWM12340      | 7314150274925 | 1 | 104 |
| TAWM1412M      | 7314150423149 | 1 | 104 |
| TAWM1430M      | 7314150422265 | 1 | 104 |
| TAWM14340      | 7314150340835 | 1 | 104 |
| TAWM24800      | 7314150368280 | 1 | 104 |
| TAWM34800      | 7314150274932 | 1 | 104 |
| TAWM38135      | 7314150274918 | 1 | 104 |
| TAWM38135M     | 7314150502264 | 1 | 104 |
| TAWM912M       | 7314150423132 | 1 | 104 |
| TAWM9135       | 7314150340828 | 1 | 104 |
| TAWM9135M      | 7314150502271 | 1 | 104 |
| TAWM930M       | 7314150422241 | 1 | 104 |
| TAWMB14340     | 7314150489626 | 1 | 104 |
| TAWMB24650     | 7314150490103 | 1 | 104 |
| TAWMB24800     | 7314150489633 | 1 | 104 |
| TAWMB9135M     | 7314150490110 | 1 | 104 |
| TAWMB930M      | 7314150489640 | 1 | 104 |
| TEA003         | 7314150422180 | 1 | 114 |
| TEA010         | 7314150422197 | 1 | 114 |
| TEA030         | 7314150465781 | 1 | 114 |
| TEA030A        | 7314150522750 | 1 | 114 |
| TEA065         | 7314150472246 | 1 | 115 |
| TEA1100        | 7314150423170 | 1 | 115 |
| TEA2100        | 7314150465972 | 1 | 115 |
| TEA350         | 7314150422210 | 1 | 115 |
| TJS003         | 7314150522477 | 1 | 114 |
| TJS010         | 7314150522484 | 1 | 114 |
| TJS030         | 7314150522491 | 1 | 114 |
| TL 00-SA       | 7314150109579 | 1 | 656 |
| TL 00-SA-ET    | 7311518279219 | 1 | 659 |
| TL 00-SA-SL    | 7314150115228 | 5 | 660 |
| TL 000-SA      | 7314150522934 | 1 | 656 |
| TL 00ACF       | 7314150522958 | 1 | 663 |
| TL 00B-SA      | 7314150109555 | 1 | 656 |
| TL 00CFR-SA    | 7314150115402 | 1 | 658 |
| TL 00D-SA      | 7314150109562 | 1 | 656 |
| TL 0C9-SA      | 7314150109586 | 1 | 656 |
| TL 1-SA        | 7314150109647 | 1 | 656 |
| TL 1-SA-SL     | 7314150115235 | 5 | 660 |



|                |               |   |     |
|----------------|---------------|---|-----|
| TL 124-SA      | 7314150110018 | 1 | 662 |
| TL 15A         | 7314150522972 | 1 | 656 |
| TL 15AGW       | 7314150522996 | 1 | 656 |
| TL 15AGWHM-SA  | 7314150523016 | 1 | 656 |
| TL 2-SA-SL     | 7314150115242 | 5 | 660 |
| TL 242ACF      | 7314150523030 | 1 | 663 |
| TL 242CFR-SA   | 7314150523054 | 1 | 658 |
| TL 249 ACF     | 7314150115174 | 1 | 663 |
| TL 249CFR-SA   | 7314150115143 | 1 | 658 |
| TL 259 ACF     | 7314150115167 | 1 | 663 |
| TL 259 CFR-SA  | 7314150115150 | 1 | 658 |
| TL 259ACP      | 7314150465590 | 1 | 663 |
| TL 259ASV      | 7314150465569 | 1 | 663 |
| TL 259CPR-SA   | 7314150523078 | 1 | 658 |
| TL 259SVR-SA   | 7314150523092 | 1 | 658 |
| TL 2A ACF      | 7314150115457 | 1 | 663 |
| TL 2A-SA       | 7314150110100 | 1 | 656 |
| TL 2A-SA-ET    | 7314150523115 | 1 | 659 |
| TL 2A-SA-SL    | 7314150115259 | 5 | 660 |
| TL 2ACFR-SA    | 7314150115419 | 1 | 658 |
| TL 3-SA        | 7314150110162 | 1 | 657 |
| TL 3-SA-ET     | 7311518279356 | 1 | 659 |
| TL 3-SA-SL     | 7314150115266 | 5 | 660 |
| TL 34A-SA      | 7314150524068 | 1 | 657 |
| TL 3C-SA       | 7314150110148 | 1 | 657 |
| TL 3C-SA-ET    | 7314150523139 | 1 | 659 |
| TL 3C-SA-SL    | 7314150115273 | 5 | 660 |
| TL 4-SA-SL     | 7314150115280 | 5 | 660 |
| TL 475-SA      | 7314150110032 | 1 | 662 |
| TL 5-SA        | 7314150110247 | 1 | 657 |
| TL 5-SA-ET     | 7314150523153 | 1 | 659 |
| TL 5-SA-SL     | 7314150115297 | 5 | 660 |
| TL 51S-SA      | 7314150110209 | 1 | 657 |
| TL 578-SA      | 7314150110438 | 1 | 662 |
| TL 582-SA      | 7314150110452 | 1 | 662 |
| TL 5A-SA-SL    | 7314150115303 | 5 | 660 |
| TL 5ACF        | 7314150115464 | 1 | 663 |
| TL 5ACP        | 7314150465606 | 1 | 664 |
| TL 5ASV        | 7314150465576 | 1 | 663 |
| TL 5B-SA       | 7314150110223 | 1 | 657 |
| TL 5CF-SA      | 7314150523177 | 1 | 658 |
| TL 5CFR-SA     | 7314150115426 | 1 | 658 |
| TL 5CPR-SA     | 7314150523191 | 1 | 658 |
| TL 5SVR-SA     | 7314150523214 | 1 | 658 |
| TL 6-SA        | 7314150523238 | 1 | 657 |
| TL 648-SA      | 7314150110049 | 1 | 662 |
| TL 649-SA      | 7314150110063 | 1 | 662 |
| TL 65A-SA      | 7314150110278 | 1 | 657 |
| TL 7-SA        | 7314150110292 | 1 | 657 |
| TL 7-SA-ET     | 7314150523252 | 1 | 659 |
| TL 7-SA-SL     | 7314150115310 | 5 | 661 |
| TL 7A-SA       | 7314150110285 | 1 | 657 |
| TL 7A-SA-ET    | 7314150523283 | 1 | 659 |
| TL 7A-SA-SL    | 7314150115327 | 5 | 661 |
| TL 7ACF        | 7314150115471 | 1 | 664 |
| TL 7ACP        | 7314150465613 | 1 | 664 |
| TL 7ASV        | 7314150465583 | 1 | 664 |
| TL 7CFR-SA     | 7314150115433 | 1 | 659 |
| TL 7CPR-SA     | 7314150523306 | 1 | 659 |
| TL 7SVR-SA     | 7314150523320 | 1 | 659 |
| TL AA-SA-ET    | 7314150523344 | 1 | 659 |
| TL AA-SA-SL    | 7314150115334 | 5 | 660 |
| TL AC-SA-SL    | 7314150115341 | 5 | 660 |
| TL MM-SA-SL    | 7314150115365 | 5 | 661 |
| TL SM 103-SA   | 7314150110773 | 1 | 662 |
| TL SM 104-SA   | 7314150110780 | 1 | 661 |
| TL SM 105-SA   | 7314150110797 | 1 | 661 |
| TL SM 107-SA   | 7314150110810 | 1 | 661 |
| TL SM 108-SA   | 7314150110827 | 1 | 661 |
| TL SM 109-SA   | 7314150110834 | 1 | 661 |
| TL SM 110-SA   | 7314150110841 | 1 | 661 |
| TL SM 111-SA   | 7314150110858 | 1 | 661 |
| TL SM 115-SA   | 7314150110896 | 1 | 662 |
| TL SM 117-SA   | 7314150110919 | 1 | 662 |
| TL SM106-SA    | 7314150523368 | 1 | 661 |
| TL SM116-SA    | 7314150523382 | 1 | 661 |
| TL SM116-SA-ET | 7314150523405 | 1 | 659 |
| TL SS-SA       | 7314150109937 | 1 | 657 |
| TL SS-SA-SL    | 7314150115358 | 5 | 660 |
| TR0325M03X-50  | 7314150501632 | 5 | 148 |
| TR0636M06X-65  | 7314150501663 | 5 | 148 |
| TR0650M06X-80  | 7314150501694 | 5 | 148 |
| TR0860M08X-110 | 7314150507269 | 5 | 148 |
| TR4.530M06X-90 | 7314150501755 | 5 | 148 |
| TRX 8180       | 7314150112272 | 5 | 654 |
| TSS120         | 7314150347063 | 1 | 112 |
| TSS600         | 7314150346417 | 1 | 112 |
| W-S-1.5        | 7311518140816 | 4 | 601 |
| W-S-2.0        | 7311518140823 | 4 | 601 |



|              |               |    |     |
|--------------|---------------|----|-----|
| W-S-2.5      | 7311518140830 | 4  | 601 |
| W-T-2.0      | 7311518140847 | 4  | 601 |
| WBB1000      | 7314150431502 | 4  | 612 |
| WBB1200      | 7314150431519 | 4  | 612 |
| WBB1500      | 7314150431526 | 4  | 612 |
| WBB400       | 7314150315215 | 10 | 612 |
| WBB500       | 7314150315222 | 10 | 612 |
| WBB600       | 7314150315239 | 10 | 612 |
| WBB700       | 7314150315246 | 6  | 612 |
| WBB800       | 7314150340972 | 6  | 612 |
| WBF380       | 7314150315253 | 12 | 612 |
| WBMF190      | 7314150315260 | 24 | 612 |
| WBMF190IP    | 7314150457960 | 15 | 612 |
| WBP-3P-3FMMF | 7314150444335 | 1  | 612 |
| WBP-3P-6FMMF | 7314150453115 | 1  | 613 |
| WBP-3P-96F   | 7314150453108 | 1  | 613 |
| WBP300       | 7314150315161 | 20 | 612 |
| WBP500       | 7314150315178 | 12 | 612 |
| WBP625       | 7314150315185 | 12 | 612 |
| WBP710       | 7314150315192 | 10 | 612 |
| WBP900       | 7314150315208 | 6  | 612 |
| WC-HOL       | 7314150333158 | 1  | 573 |
| WPH 2-50     | 7314150520428 | 1  | 609 |
| WPH 3-20     | 8412814125435 | 1  | 609 |
| WPH 3-30     | 8412814125442 | 1  | 609 |
| WR1          | 7314150167425 | 50 | 543 |
| WR1-MM       | 7314150220069 | 50 | 543 |
| WR2          | 7314150167432 | 25 | 543 |
| WR2-12       | 7314150185627 | 25 | 543 |
| WR2-MM       | 7314150220038 | 25 | 543 |
| XLARGE       | 7314150437412 | 1  | 375 |
| XXL          | 7314150504152 | 1  | 374 |
| ZHVIDEOBAT   | 8414909180244 | 1  | 360 |
| ZHVIDEOCHA   | 8414909180237 | 1  | 360 |













## Contact Us

### Argentina

A.M. de Justo 1750 3° A  
C1107AFJ - Capital Federal  
Buenos Aires  
Tel: +54 (11) 4313-1004  
Fax: +54 (11) 4893-3553

### Australia

3 Cooper Street, Smithfield,  
NSW 2164  
Tel: +61 (0) 2 8787 5700  
Fax: +61 (0) 2 9756 6130

### Беларусь

ЗАО "Эс-Эн-Эй Европа Индастриз Бисов"  
220075 СЭЗ "Минск"  
ул. Селицкого, д. 8А  
Телефон +375 (17) 389 79 50  
info.by@snaeurope.com

### Belgium

**Branch of SNA Europe (Benelux) BV**  
De Kleetlaan 12A Pegasus Park  
1831 DIEGEM  
Tel: +32 (0)2 726 03 03  
info.be@bahco.com

### Chile

Av. Americo Vesputio 2760-D  
Conchali - Santiago - Chile  
Tel: + 56 2 623 0203  
Fax: + 56 2 623 5395

### Česká republika

**SNA Europe s.r.o.**  
Holadnská 2/4  
639 00 Brno  
Tel: +420 537 022 520  
Fax: +420 537 022 200

### Danmark

Vallensbækvej 40,  
2605 Brøndby  
Tel: +45 4363 0330  
Fax: +45 4396 2456

### Deutschland

Willetstraße 10  
40822 Mettmann  
Tel: +49 (0) 2104 833 83 0  
Fax: +49 (0) 2104 833 83 7999

### España

c/ Hilanderas, 1  
(P.O. Box / Arpo de Correos nº 5)  
C.P. 20303 Irún  
Tel: +34 902 235 100 / +34 943 649 111  
Fax: +34 943 649 120

### Ελλάδα

Λ. Βουλιαγμένης 604Γ  
167 77 Ελληνικό, Αθήνα  
Τηλ: +30 210 9914263  
Fax: +30 210 9914587

### Export

Antigua Carretera de Altube Km 5,5  
P.O.Box 307  
01080 VITORIA (Spain)  
Tel: +34 945269711  
Fax: +34 945165040

### France

ZAC de l'Hoirie  
20 rue Charles Lacretelle  
CS 60101  
49072 Beaucouzé cedex  
Tél: +33 (0) 2 41 22 98 40  
Fax: +33 (0) 2 41 22 98 50

### Italia

**SNA EUROPE Italia S.p.A.**  
Via Georges Bizet, 13/15  
20092 Cinisello Balsamo MI - Italia  
Tel. +39 02 3024161  
info.it@snaeurope.com

### Казахстан

050000, Алматы,  
ул.Шевченко 1656/72г, оф.217  
Тел/факс +7 727323 63 39

### Nederland

Vossenbeemd 113  
5705 CL Helmond  
Tel: +31 (0) 492 58 23 82  
info.nl@bahco.com

### New Zealand

Unit 3/25 Highbrook Drive  
East Tamaki  
Auckland  
Tel: +64 9-273 46 50  
Fax: +64-9-273-2453

### Norge

Box 800  
1306 Sandvika  
Tel: +47 40 49 66 00

### Österreich

Vienna, Nineteen, Mooslackengasse 17  
A - 1190 Wien  
Tel: +49 (0) 2104 8 33 83 0  
Fax +49 (0) 2104 833 83 79 99

### Polska

ul. Marynarska 15  
02-674 Warszawa  
Tel.: +48 (0) 22 6070510  
Fax: +48 (0) 22 6070521

### Россия

ООО "Эс-Эн-Эй Юроп (РУС)"  
141407 г. Химки  
ул. Панфилова вл.21, стр.1  
Телефон +7 (495) 221 58 51  
info.ru@snaeurope.com

### Portugal

**SNA Europe [Industries] LDA**  
R. Maria Julia M. Ramos - Junqueira  
4480-254 Vila Do Conde  
Tel. +351 252 650 131  
Fax. +351 252 650 160

### Slovenská republika

**SNA Europe s.r.o.**  
Karadžičova 8/A  
821 08 Bratislava  
Tel: +421 (0)2 5939 6124  
Fax: +421 (0)2 5939 6217

### SRBIJA

**Vermax-alati doo**  
Ul. Drage Spasić 35  
11000 Beograd  
Tel: +381 11 2360 500  
Tel: +381 11 2360 900  
Fax: +381 11 2361 147  
e-mail: office@vermax.rs

### Suomi

**SNA Europe Oy**  
PL 6580  
00002 Helsinki  
Finland  
Tel: +358 207 433 510  
Fax: +358 207 433 525

### Sverige

**SNA Europe Industries AB**  
Box 83  
SE-745 22 Enköping  
Tel: +46 (0) 171-47 82 00  
Fax: +46 (0) 171-47 82 38

### Schweiz / Suisse

Willetstraße 10  
40822 Mettmann  
Tel: +49 (0) 2104 833 83 0  
Fax: +49 (0) 2104 833 83 7999

### Türkiye

Girne Mah. Maltepe Küçük San. Sitesi  
F Blok No:19 Maltepe  
Istanbul  
Tel: +90 (0) 216 367 10 21  
Fax: +90 (0) 216 367 11 71

### Украина

«Бахко Бисов Свенска Акциеболаг»  
SNA Europe [Ukraine & Moldova]  
Телефон +38 067 441 16 09  
офис 555, улица Армянская, 6А  
Киев, Украина

### United Kingdom

Moorhead Way, Bramley,  
Rotherham, South Yorkshire S66 1YY  
Tel: +44 (0) 1709 731731  
Fax: +44 (0) 1709 731741



## Warranty

For warranty info please check your local website [www.bahco.com](http://www.bahco.com)





This catalogue comprises our current product assortment. Changes in the assortment as well as change of net shapes, forms, designs and designations are made continuously. No specific information will necessarily be issued to this effect.

Illustrations and drawings have been reproduced to be as accurate as possible. For the purposes of a catalogue they may, however, differ from the products themselves, as may the technical specifications.

Indications of weight are to be understood as approximate net weights, and serve primarily to facilitate calculations of freight and postage charges.

This catalogue supersedes all previous specifications and assortment lists.

The intellectual property in this catalogue is the property of SNA Europe. Excerpts, reprints or copies of the contents may be made with our permission

# 2024







[www.bahco.com](http://www.bahco.com)

M-ENG-CAT-24



7 314150 546657